



Genel Katalog



Genel Katalog General Catalog

Şabanođlu Mah.
73. Sk. No. 39
Tekkeköy / SAMSUN
Tel: 0 362 233 00 61
0 543 456 73 62
Fax: 0 362 233 00 71

www.argentcerrahialetler.com
bilgi@argentcerrahialetler.com



ŞİRKET

Cerrahi Aletler Üretim hizmetleriyle Tıp Endüstrisi alanında profesyonel destek sağlamak amacıyla ARGENT CERRAHİ ALETLER SANAYİ VE TİCARET LİMİTED ŞİRKETİ 2016 yılında Samsun'da kurulmuştur.

Samsun Organize Sanayide hizmet veren kurumumuz Genel Cerrahi, Göz, Kbbi Plastik, Beyin, Ortopetik, Sterilizasyon Konteynır Sistemleri, Cerrahi Motor teknik bakım Ar-Ge hizmetleri sunmaktadır. Her geçen gün kalite standartlarını ve üretim kapasitesini arttıran Argent Cerrahi Aletler Tıp Endüstrisi Cerrahi ihtiyaçlarını büyük ölçüde karşılamakta kaliteli ve profesyonel hizmetler sunmaktadır.



ARGENT SURGICAL INSTRUMENTS INDUSTRY AND TRADE LIMITED COMPANY was established in Samsun in 2016 in order to provide professional support in the field of Medical Industry with Surgical Instruments Production Services.

Samsun Organize Our company serving in the industry General Surgery, Eye, Plastic, Brain, Orthopedic, Sterilization Container Systems, Surgical Motor technical maintenance R & D services. The Argent Surgical Instruments Medical Industry, which increases the quality standards and production capacity with each passing day, is qualified and professional to meet the surgical needs to a great extent services.

Bütün branşlar için üretilen cerrahi alet ve aparatlar, klasik ve modern cerrahi tekniklerine uygun olarak üretilmektedir. Yüksek kalite için Alman paslanmaz çelik ham malzeme kullanılmaktadır.

The surgical hand instruments and apparatus are produced in accordance with the classical and modern surgical techniques for all branches. German stainless steel raw material is used for high quality.





Argent ; çok sayıda yerli ve yabancı, faydalı model patent ve tasarım sahibidir. Mevcut ürünlerin geliştirilmesi ve yeni üretim metodlarının araştırılması çalışmalarına aralıksız devam etmektedir.

AR-GE
R&D



Argent is an owner of many local and international utility model, patent and industrial design documents. Work of improvement of current products and research of new production methods are carried out continuously.

GARANTİ GUARANTEE

Argent markası ile tedarik edilen ürünler, işçilik ve malzeme hatalarına karşı garantilidir. Garanti periyodu içerisinde hatalı malzemeler yenileri ile değiştirilir. Garanti kapsamı dışında kalan aletlerin de bakımı ve onarımı yapılmaktadır. Bu hizmet sadece ürünlerimiz için sınırlandırılmıştır.

The products under Argent brand are guaranteed for the defects stemming from workmanship and material. Within the guarantee period, the defected material is replaced with a new one. Maintenance and repair service of the instruments also be given to the items that are out of guarantee. This service is bounded to our products only.





AN Muayene, Ölçme, Hazırlık ve Anestezi Aletleri
Diagnostic, Measuring, Preparation and Anaesthesia Instruments
1-12



BA Bıçaklar, Bistüri Sapları ve Dermatomlar
Knives, Scalpel Handles and Dermatomes
13-26



BC Makaslar
Scissors
27-96



BD Pensetler
Forceps
97-132



BF Spanç, Doku ve Çamaşır Pensleri
Sponge, Tissue and Washing Forceps
133-160



BM Portegüler ve Sütur Aletleri
Needle Holders and Suture Instruments
161-206



BH

Hemostatik Pensler, Diseksiyon Pensleri, Histerektomi Pensleri
Haemostatic Forceps, Dissecting Forceps, Hysterectomy Forceps

207-258



FB

Kalp Damar Cerrahi
Cardiovascular and Thoracic Surgery

259-298



BN

Sondalar, Aspiratör Uçları, Trokarlar ve Biyopsi İğneleri
Probes, Suction Tubes, Trocars and Biopsy Needles

299-318



BT

El Ekartörleri, Huklar ve Spatulalar
Retractors, Hooks and Spatulas

319-392



BV

Otomatik Ekartörler
Self-Retaining Retractors

393-436



GC

Genel Cerrahi
General Surgery

437-484



UR

Ürolojik Aletler
Genito-Urinary Instruments

485-506



JN

Jinekolojik Aletler
Gynaecological Instruments

507-576



KR

Kalp ve Damar Cerrahi
Cardiovascular and Thoracic Surgery

577-612



FK

Raspalar, Disektörler ve Elevatörler
Raspatories, Dissectors and Levers

613-674



FG

Kemik Küretleri
Bone Curettes

675-694



FO

Kemik Pensleri, Ronjurları, Makasları ve Pançları
Bone Holding Forceps, Rongeurs, Scissors and Punches

695-730



OK

Ronjurlar
Rongeurs

731-744



FF

Beyin Cerrahi
Neurosurgery

745-792



LX

Ortopedik Cerrahi
Orthopedic Surgery

793-828



FH

Anatomi, Amputasyon ve Otopsi Aletleri
Instruments For Anatomy, Amputation and Post Mortem

829-836



HH

Dermatoloji
Dermatology

837-842



FD

Mikroskopi
Microscopy

843-846



GK

Elektrocerrahi Aletleri
Electrosurgical Instruments

847-864



JG

Taslar, Böbrek Tasları
Bowls, Kidney Trays

865-868



A-Z

Alfabetik İndeks
Alphabetical Index

873-902

0-9

Sayısal İndeks
Numerical Index

903-927

AN Muayene, Ölçme, Hazırlık ve Anestezi Aletleri
Diagnostic, Measuring, Preparation and Anaesthesia Instruments



 **ARGENT**



OM 580.00
14.5 cm



OM 580.01
14 cm



BUCHWALD
OM 581.00
18 cm

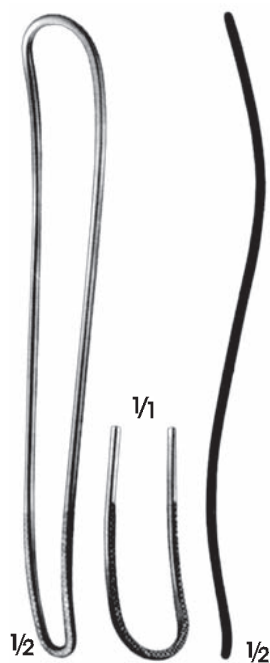

FRENZEL
OM 585.00
16.5 cm



BRÜNINGS
OM 583.00
19 cm



$\frac{1}{2}$
OM 202.00
Ağız açıcı
Mouth gag
12.5 cm



$\frac{1}{2}$
FERGUSON-ACKLAND
OM 200.00
Ağız açıcı
Mouth gag
14.5 cm



$\frac{1}{2}$
OM 201.00
Ağız açıcı
Mouth gag
16 cm



$\frac{1}{2}$
ROSER-KÖNIG
OM 203.00
Ağız açıcı
Mouth gag
18.5 cm



$\frac{1}{1}$
SCHMID
OM 199.00
Ağız açıcı, ayarlanabilir
Mouth opening, adjustable



$\frac{1}{2}$
HEISTER
OM 206.00
Ağız açıcı
Mouth gag
13 cm



$\frac{1}{2}$
FD 100.00
Tahta ağız açıcı
Mouth gag wooden
14 cm



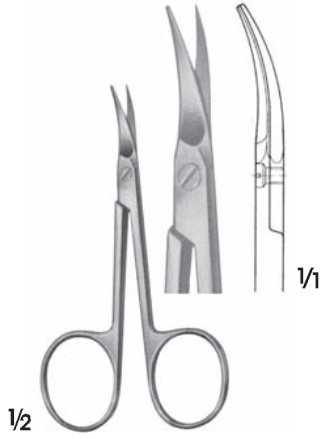

BC 217.01
Tırnak makası
Nail scissors
9 cm

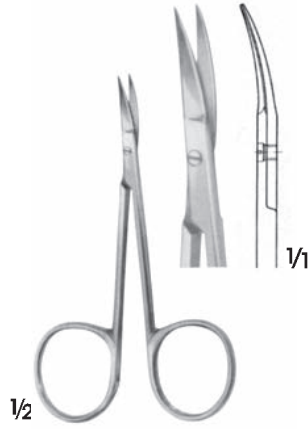

BC 217.00
Tırnak makası, hassas
Nail scissors, delicate
9 cm

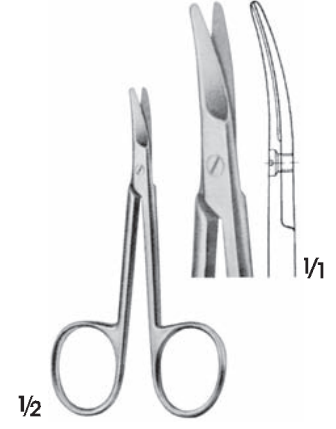

BC 218.00
Bebek tırnak makası
Baby nail scissors
8.5 cm



BC 222.00
Düz/Straight

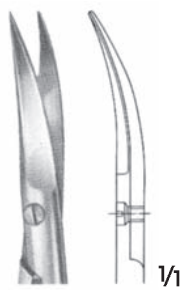

BC 223.00
Eğri/Curved

BC 222.00-BC 223.00
Hassas makaslar Delicate
scissors
9 cm

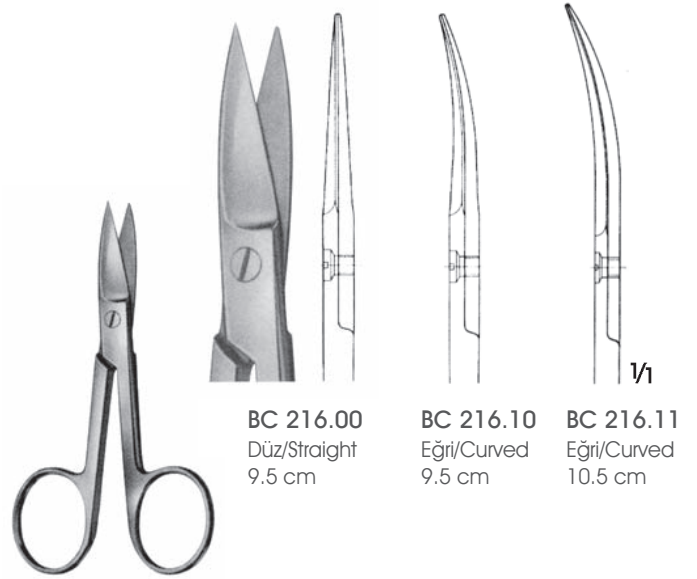

BC 216.00
Düz/Straight
9.5 cm

BC 216.10
Eğri/Curved
9.5 cm

BC 216.11
Eğri/Curved
10.5 cm

BC 216.00
BC 216.10-BC 216.11
Tırnak makasları
Nail Scissors



BC 219.00-BC 219.12
Tırnak makasları
Nail Scissors



BC 219.00
Düz/Straight
9 cm



BC 219.10
Eğri/Curved
9 cm



BC 219.11
Eğri/Curved
10 cm



BC 219.12
Eğri/Curved
11 cm



1/2

FO 681.00
Tırnak makası
Nail cutter
13.5 cm



1/1



1/2

FO 682.00
Tırnak makası
Nail cutter
14.5 cm



1/1



1/1

FK 337.00
Tırnak törpüsü
Nail file
15 cm



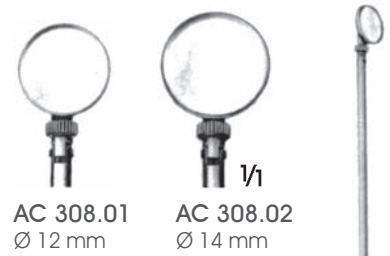
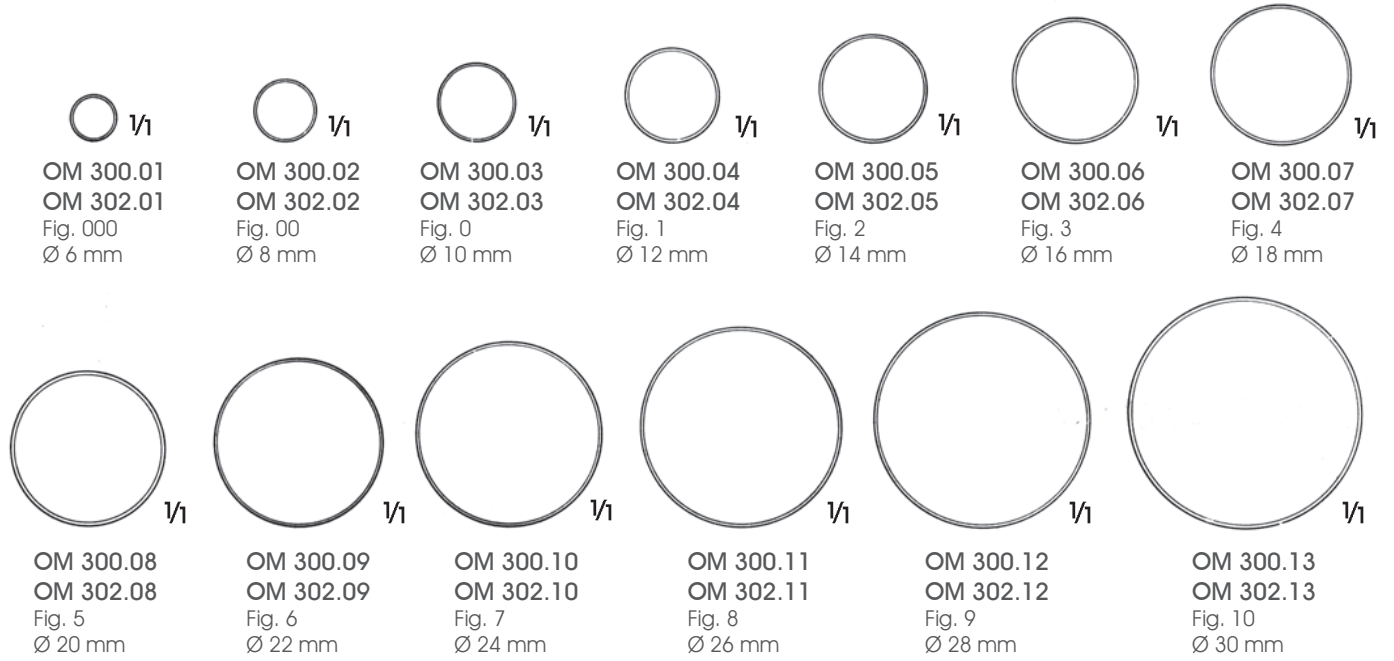

AC 300.01-AC 300.13
Altıgen saplı
laringel aynalar
Laryngeal mirrors with
hexagonal handle 18 cm



AC 302.01-AC 302.13
Laringel aynalar
Laryngeal mirrors
12 cm



AC 304.00
Ayna sapı
Mirror handle
11 cm



FO 306.00
Ayna sapı
Mirror handle
10.5 cm



MICHEL
AC 308.01-AC 308.02
Rinoskopik aynalar
(Değiştirilebilir aynalar)
Rhinoscopic mirrors,
with interchangeable mirror inserts
25 cm



AC 500.00-AC 500.04
Cetveller/Rulers

AC 500.00	10 cm
AC 500.01	15 cm
AC 500.02	20 cm
AC 500.03	30 cm
AC 500.04	50 cm



FL 766.00
Meme markörü, dişli
Mamilla marker, toothed
Ø 33 mm



FL 766.01
Meme markörü, dişli
Mamilla marker, toothed
Ø 38 mm

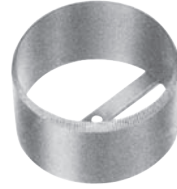

FL 766.03
Meme markörü, dişli
Mamilla marker, toothed
Ø 42 mm

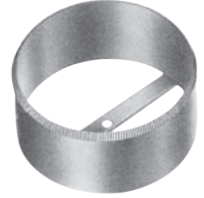

FL 766.04
Meme markörü, dişli
Mamilla marker, toothed
Ø 48 mm



1/2
AA 511.00
Nöroşürüji için özel kumpas
Caliper, special for neurosurgery
12.5 cm



1/3
AA 510.00
Kumpas/Caliper
Ölçme 150 mm
Measuring 150 mm
23 cm



1/2
AA 512.00
Kumpas/Caliper
Ölçme 100 mm
Measuring 100 mm
13 cm

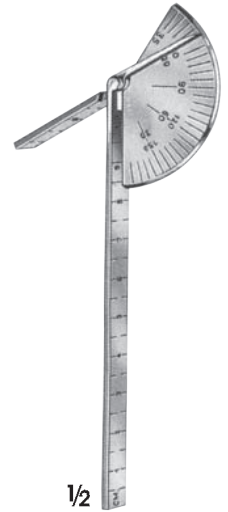

1/2
AA 523.00
Açı ölçer
Finger goniometer



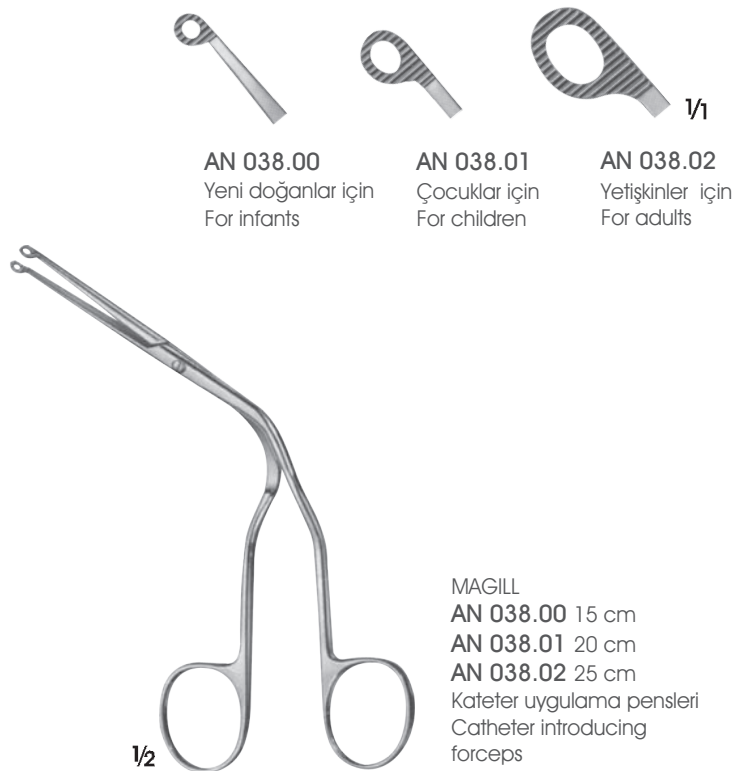
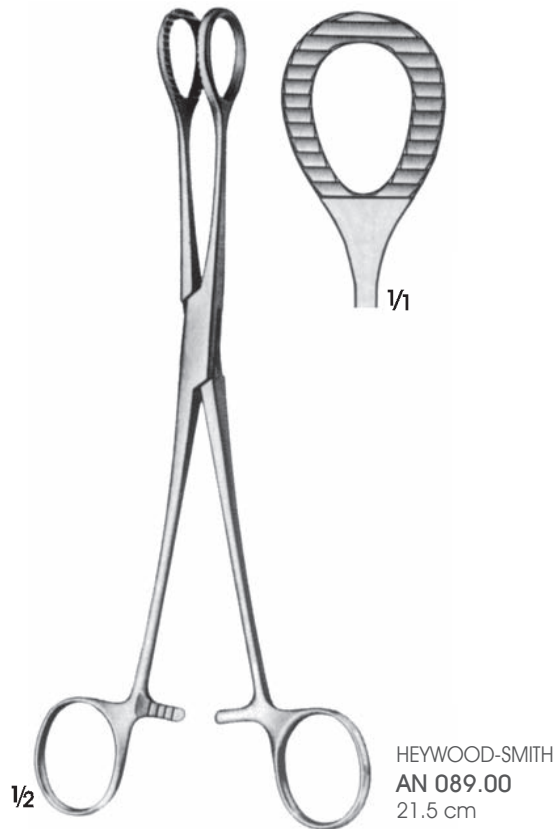
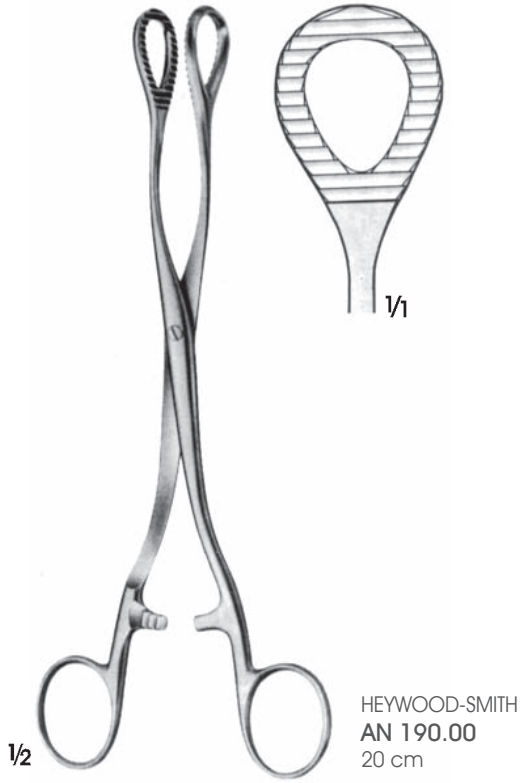

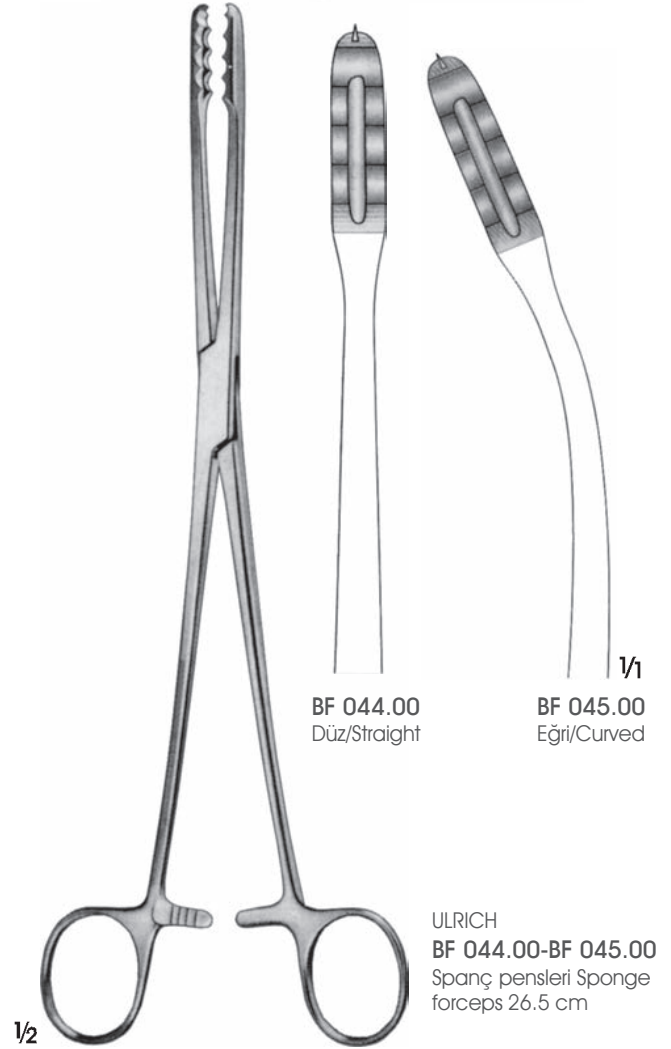
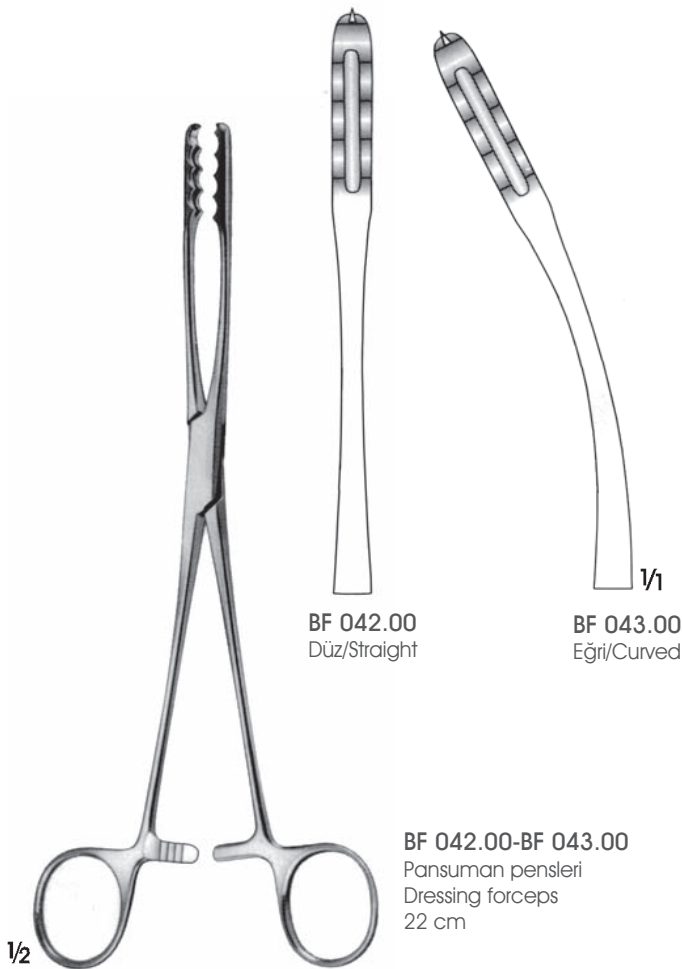
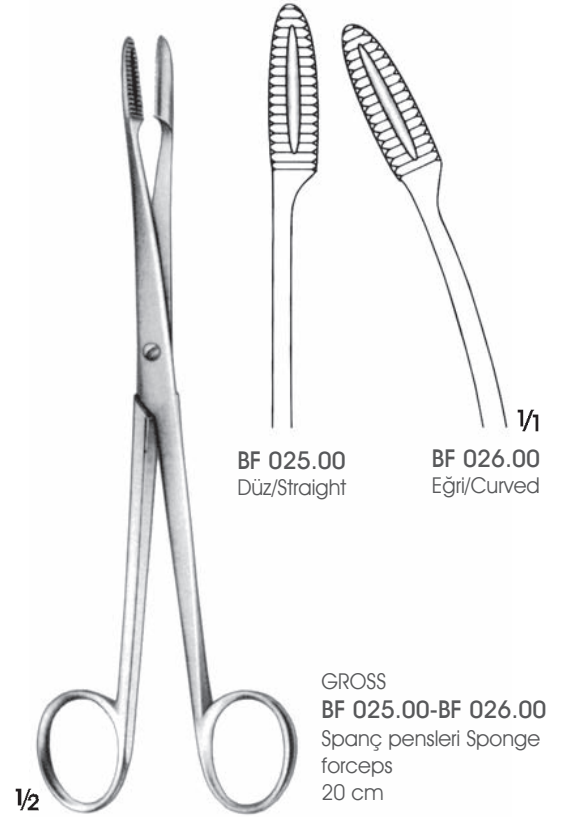
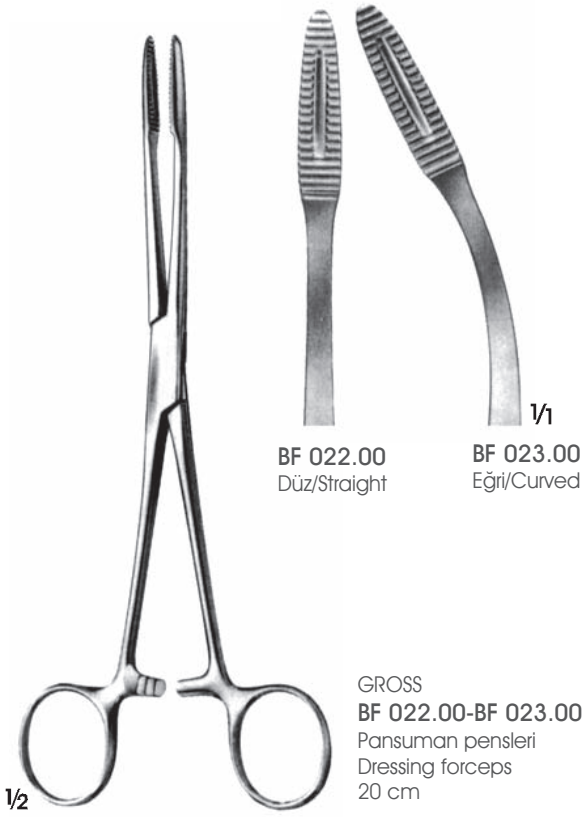



AN 881.00
Tüp klempli, sert tüpler için
Tubing clamp forceps, heavy pattern
16.5 cm



AN 885.00
Tüp klempli
Tubing clamp
18 cm



AN 884.00-AN 884.02
Tüp klempleri
Tubing clamps



AN 784.00 15 cm
AN 784.02 18 cm
AN 784.03 19 cm
AN 784.04 20 cm
Tüp klempleri Tubing
clamps

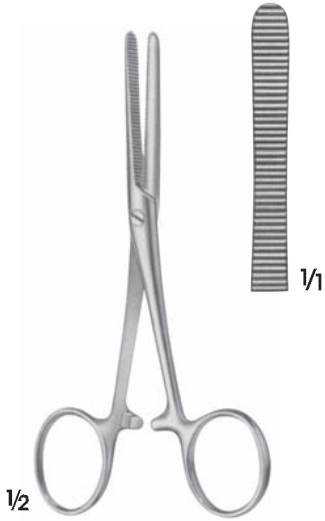

PEAN
BH 400.00
Tüp klempi
Tubing clamp forceps
12.5 cm



KLINIKUM BERLIN
AN 410.00
Uzun kilit mesafeli tüp klempi
Tubing clamp
heavy pattern, long ratchet,
therefore passage adjustable
14.5 cm



AN 883.00
Sert tüpler için, tüp klempi
Tubing clamp forceps
16.5 cm



SAUERBRUCH
JG 803.00
Tutma pensi, tampon ve çamaşırlar için
Pick-up forceps for used tampons and
dressings
55 cm

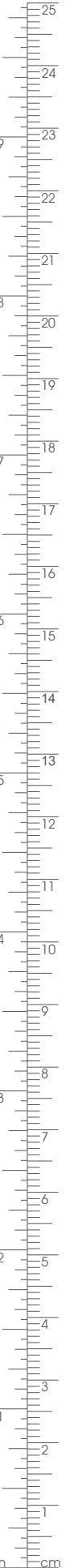

BA Bıçaklar, Bistüri Saplari ve Dermatolar
Knives, Scalpel Handles and Dermatomes



 **ARGENT**



BA 104.00 BA 104.01 BA 104.02 BA 104.03 BA 104.04 BA 104.05



BA 106.00



BA 104.00-BA104.05

BA 104.00-BA104.05
13 cm



BERGMANN
BA 106.00

BERGMANN
BA 106.00
14 cm

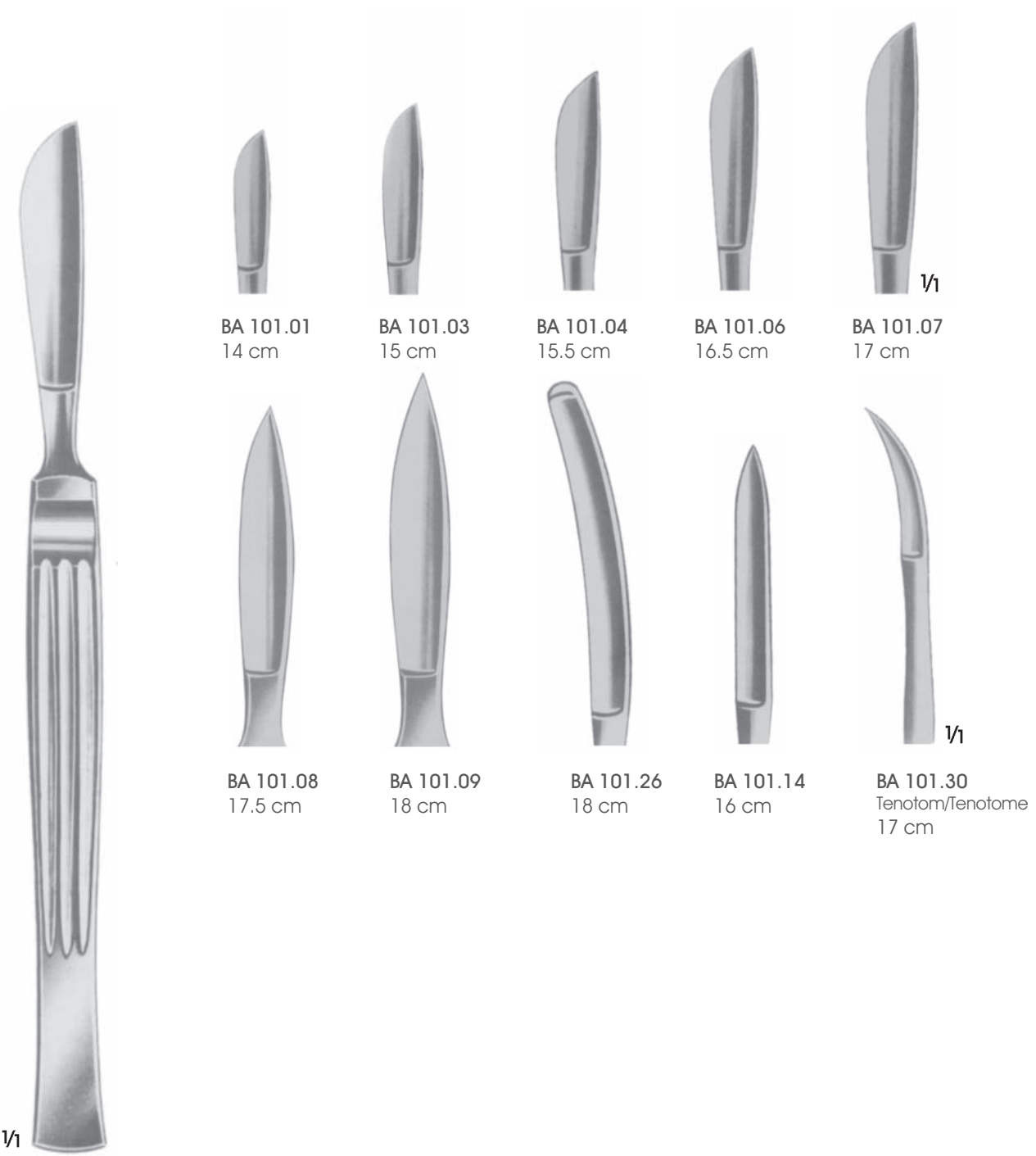

BA 101.01
14 cm

BA 101.03
15 cm

BA 101.04
15.5 cm

BA 101.06
16.5 cm

BA 101.07
17 cm

BA 101.08
17.5 cm

BA 101.09
18 cm

BA 101.26
18 cm

BA 101.14
16 cm

BA 101.30
Tenotom/Tenotome
17 cm

1/1
BA 101.01-BA 101.30



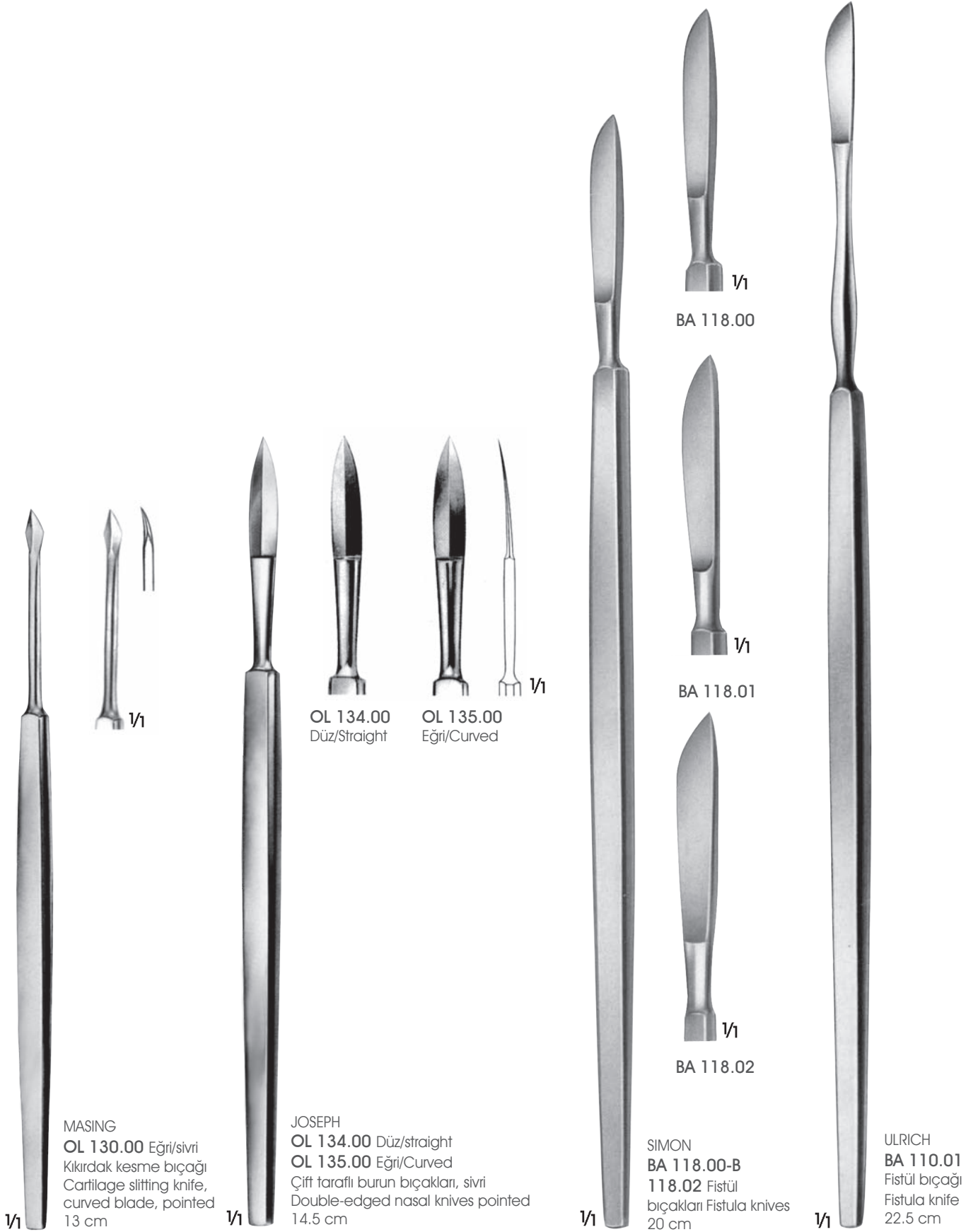



BA 111.02
Trigeminal bıçak
Trigeminal knife
23 cm

1/1



**OLIVECRONA
BA 124.00**
Trigeminal bıçak
Trigeminal knife
20.5 cm

1/1



**FOWLER
OM 122.00**
Tonsil bıçak
Tonsil knife
20 cm

1/1



**ABRAHAM
OM 125.00**
Tonsil bıçak
Tonsil knife
21.5 cm

1/1

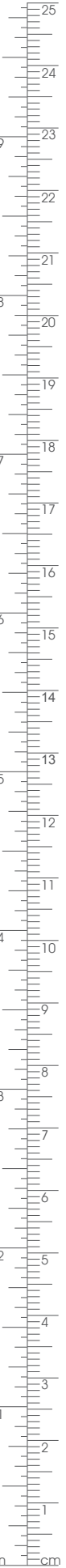

Çift taraflı kesme
Double cutting



FH 141.00
Interosseöz bıçak
Interosseous knife
Ağız uzunlukları
Length of blade
11 cm

1/2

Çift taraflı kesme
Double cutting



**LANGENBECK
FH 143.00**
Kanat bıçak
Flap knife
Ağız uzunlukları
Length of blade
12 cm

1/2



LISTON
FH 146.00 13 cm
FH 146.01 16 cm
FH 146.02 19 cm
FH 146.03 22 cm
Amputasyon bıçakları
Amputation knives
Ağız uzunlukları
Length of blade
12 cm

1/2

Çift taraflı kesme
Double cutting



**CATLIN
FH 145.00**
Amputasyon bıçak
Amputation knife
Ağız Uzunlukları
Length of blade
16 cm

1/2



1/2

FH 144.00
Falanks bıçak
Phalangeal knife
Ağız uzunlukları
Length of blade
10.5 cm



1/2

AA 163.00
Periyost bıçak
Periosteum knife
Ağız uzunlukları
Length of blade
6.5 cm



1/2

LANGENBECK
AA 160.00-
AA 161.00
Rezeksiyon bıçakları
Resection knives
Ağız uzunlukları
Length of blade
5.5 cm



AA 160.00

AA 161.00

1/1





1/2

SILVER
BA 186.00P
Cilt nakil dermatomu, bıçaksız
Dermatome skin transplant,
bladeless
19 cm



1/2

REHN
BA 180.00
23.5 cm

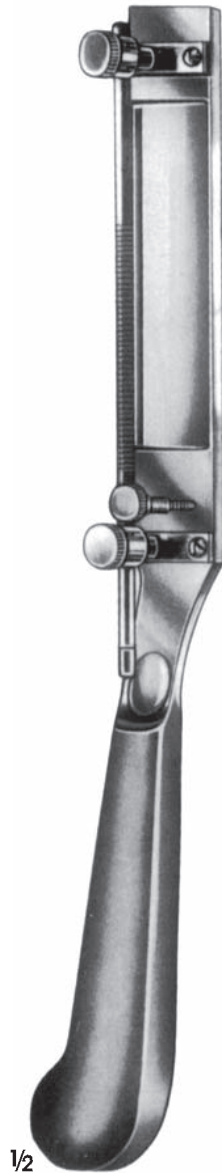

1/2

SCHINK
BA 182.00
Sadece dermatom
Only dermatome
30 cm



BA 188.01
Sadece yedek bıçak
Spare blade only

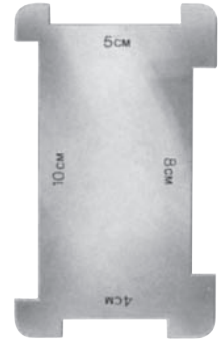

BA 188.00
Sadece cilt doğrultma
plakası
Skin straightening plate
only

SCHINK
BA 182.01
Dermatom 0.1mm'den 2.0 mm kadar
ayarlanabilir, 1 adet değiştirilebilir B 188.01 ve
2 adet B 188.00 deri düzeltme plakası ile birlikte komple
Dermatome, adjustable from 0.1mm to 2.0 mm
complete, with 1 interchangeable blade and 2 skin
straightening plates
30 cm

Sabit bar
Bar fixed



1/2

WATSON
BA 184.00
Cilt nakil dermatomu, bıçaksız
Volume transport dermatome,
bladeless
30 cm

Tırıklı bar
Knurled bar



1/2

COBBETT
BA 187.00
Cilt nakil dermatomu, bıçaksız
Volume transport dermatome,
bladeless
31.5 cm

Dönebilir, tırıklı bar
Rotable toothed bar



1/2

BRAITHWAITE
BA 185.00
Cilt nakil dermatomu, bıçaksız
Volume transport dermatome,
bladeless
31.5 cm



1/2

HUMBY
BA 190.00
Cilt nakil dermatomu, bıçaksız
Volume transport dermatome,
bladeless
36.5 cm

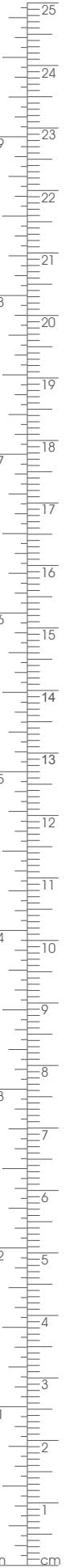



1/1

BB 040.00
No. 4
13.5 cm



1/1

BB 040.01
No. 4
13.5 cm



BB 030.00
No. 3
12.5 cm



1/1

BB 030.01
No. 3
12.5 cm



1/1

BB 033.00
No. 7
16 cm



BARRÉ

BB 036.00-BB 036.01
No. 3XL
Sol el için/For left hand
25 cm



BB 036.00



1/1

BB 036.01



BARRÉ

BB 035.00
25 cm

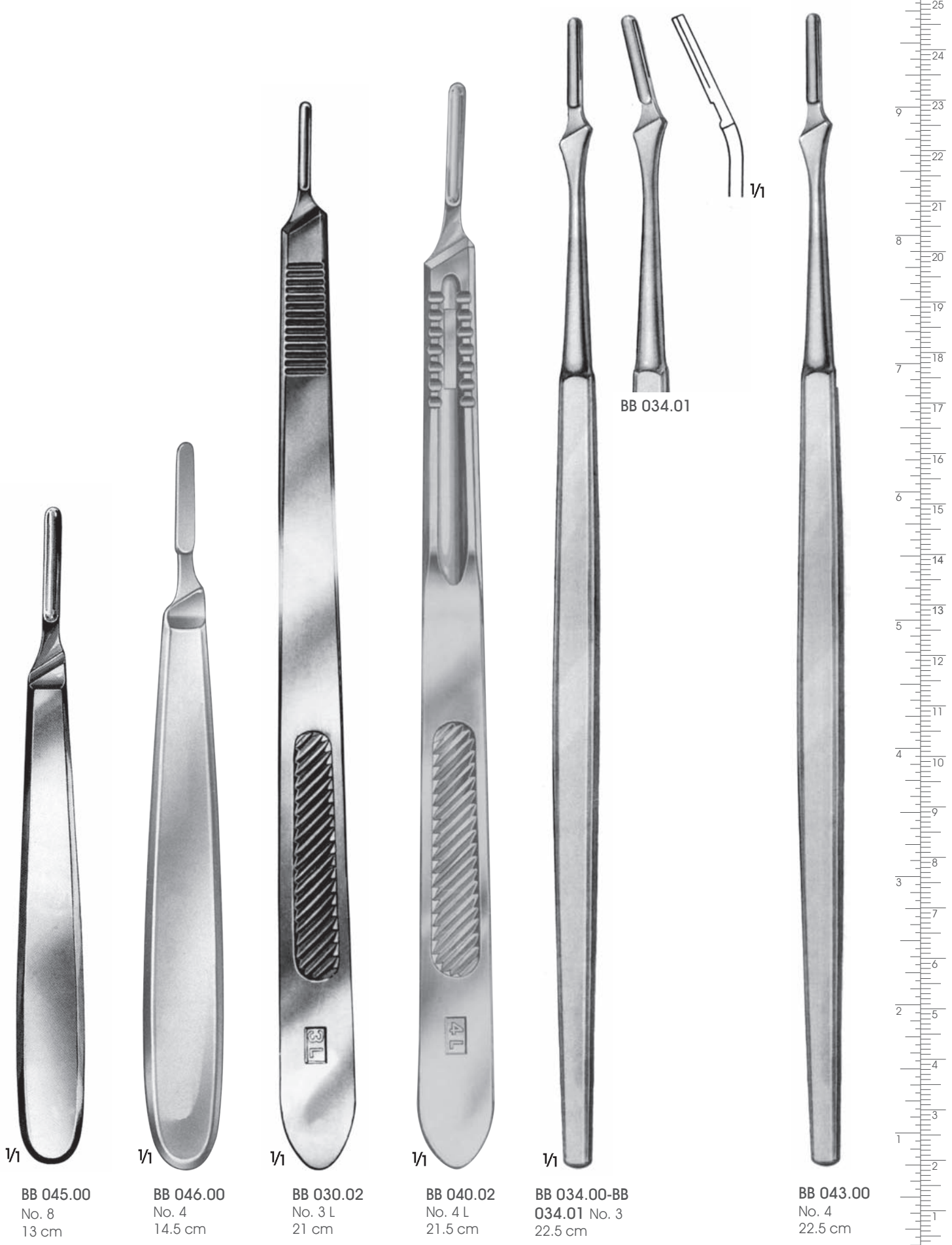





LANDOLT
BB 024.00
Bistüri sapı bayonet
yuvarlak saplı
Scalpel handle, bayo-
net-shaped, round
25 cm



1/1

BB 020.00
No. 3
21 cm



1/1

LANDOLT
BB 022.00
Bistüri sapı bayonet
kare saplı
Scalpel handle,
bayonet- shaped square shank
21 cm

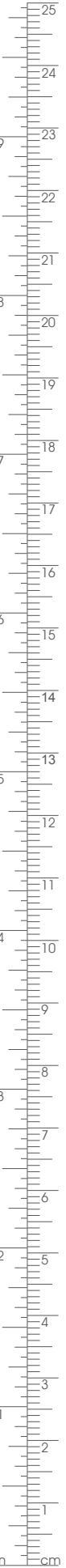

BC Makaslar
Scissors



 ARGENT

Düz Saplı ve Çapraz Tırtıllı Mikro Makaslar(Yaylı Tip)
Micro Scissors (Spring Type) with Flat Handles and Cross-Serration

Düz Saplar ve çapraz tırtıl :
Sağlam kavrama özelliği sağlar.

Flat handles and cross serration:
Provides a solid grip.

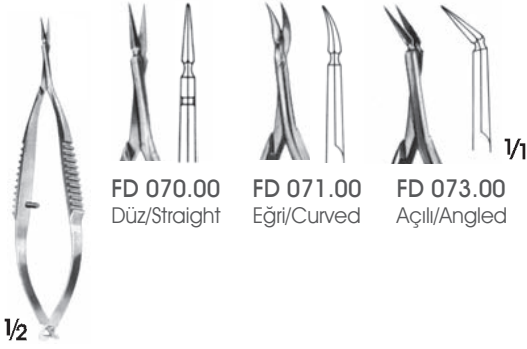

FD 070.00
Düz/Straight

FD 071.00
Eğri/Curved

FD 073.00
Açılı/Angled

1/2

VANNAS
FD 070.00-FD 073.00
Hassas/Delicate
8.5 cm



1/2

MC CLURE
FD 076.00
Düz/Straight
Göz makası/Eye scissors
9.5 cm



OC 100.00
Düz/Straigh

OC 101.00
Eğri/Curved

1/2

OC 100.00-OC 101.00
Göz makasları/Eye scissors
10.5 cm



FD 102.00
Düz/Straight

FD 103.00
Eğri/Curved

1/2

FD 102.00-FD 103.00 Mikro
makaslar/Micro scissors 12 cm



1/2

VANNAS
FD 106.00
Düz/Straight
Mikro makas/Micro scissors
12 cm



1/2

VANNAS
FD 107.00
Mikro makas/Micro scissors
12 cm

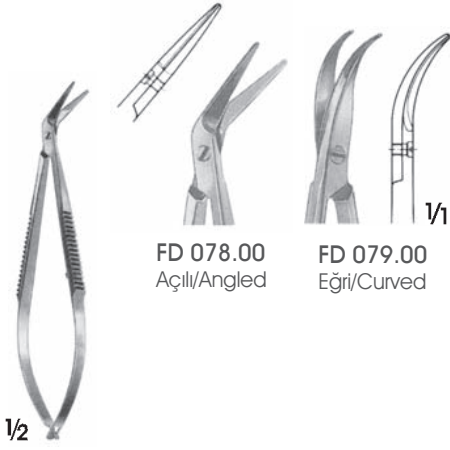

FD 078.00
Açılı/Angled

FD 079.00
Eğri/Curved

CASTROVIEJO
FD 078.00-FD 079.00
Göz makasları/Eye Scissors
9.5 cm

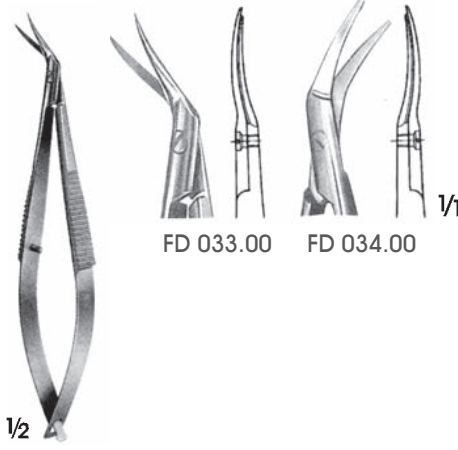

FD 033.00

FD 034.00

CASTROVIEJO
FD 033.00-C 034.00
Göz makasları/Eye scissors
11 cm

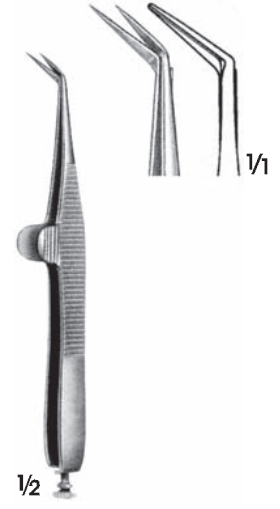

WECKER
FD 061.04 Uçları sivri/Pointed-pointed
FD062.04 Sivri, künt, sağ/Pointed-blunt, right
FD 063.04 Sivri, künt, sol/Pointed-blunt, left
FD 064.04 Uçları künt/Blunt-blunt
Göz makasları/Eye scissors
11 cm



VANNAS
FD 108.00
Mikro makas/Micro scissors
Düz açılı/Angled on flat
12 cm



NOYES
OC 109.00
Göz makası/Eye scissors
Düz/Straight
12.5 cm

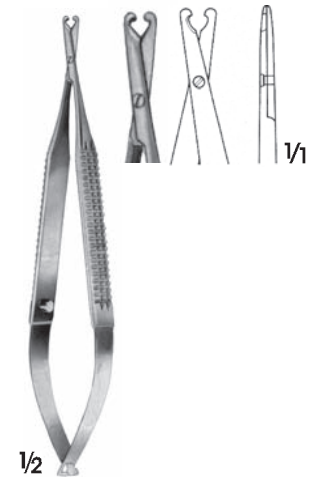

FD 110.00
Damar ucunu pürüzsüzleştirmek için damar makası
Vein scissors for roughening
Vessel ends
13 cm



Düz Saplar ve çapraz tırtıl :
Sağlam kavrama özelliği sağlar.

Flat handles and cross serration:
Provides a solid grip.



1/2

FD 112.00-FD
113.00 16 cm



FD 112.00
Düz/Straight



FD 113.00
Eğri/Curved

1/1



1/2

VANNAS
FD 116.00-FD
117.00 16 cm

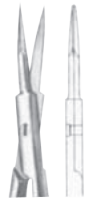

FD 116.00
Düz/Straight



FD 117.00
Eğri/Curved

1/1



1/2

MILLESİ
FD 120.00-FD
121.00 Çift ağız tırtıllı
Both jaws serrated 16
cm



FD 120.00
Düz/Straight



FD 121.00
Eğri/Curved

1/1



1/2

FD 124.00-FD 125.00
18.5 cm



YASARGIL
FD 124.00
Düz/Straight



JACOBSON
FD 125.00
Eğri/Curved

1/1



1/2

FM 168.08-FM 168.18
Düz/Straight
16.5 cm



FM 168.08
Ultra hassas bleyd
Ultra delicate blade



FM 168.18
Hassas bleyd
Delicate blade

1/1



1/2

FM 168.09-FM 168.19
Eğri/Curved
16.5 cm



FM 168.09
Ultra hassas bleyd
Ultra delicate blade



FM 168.19
Hassas bleyd
Delicate blade

1/1

Yuvarlak Saplar

- Parmaklar arasında istenildiği şekilde döndürmeye izin verir.
- Sağlam veya oyulmuş saplardan dolayı her bir alette optimum denge sağlar.

Round Handle

- Allows rotation between the fingers as required
- Due to carved and strong handle, each instrument provides optimum balance.

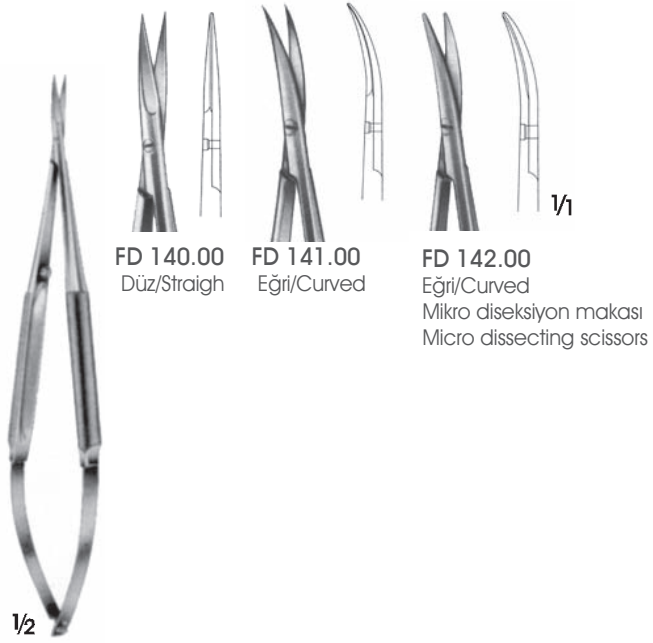

FD 140.00
Düz/Straight

FD 141.00
Eğri/Curved

FD 142.00
Eğri/Curved
Mikro diseksiyon makası
Micro dissecting scissors

FD 140.00-FD 142.00
14.5 cm

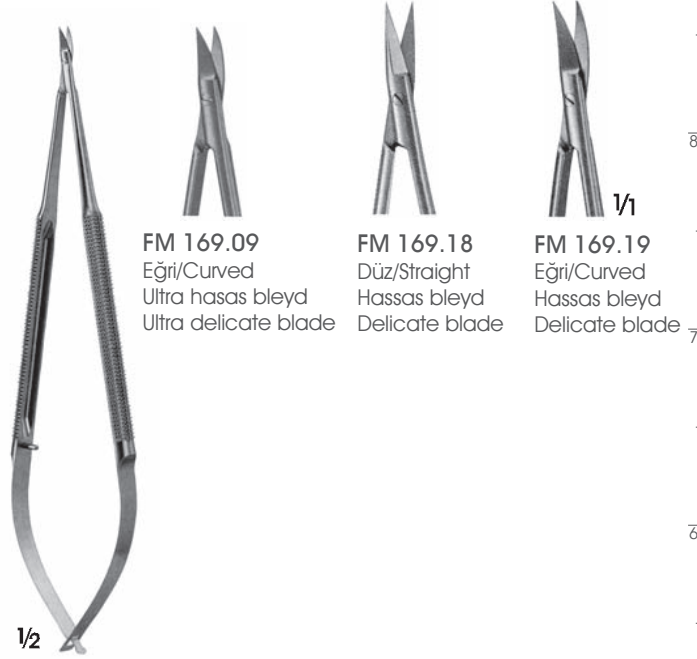

FM 169.09
Eğri/Curved
Ultra hasas bleyd
Ultra delicate blade

FM 169.18
Düz/Straight
Hassas bleyd
Delicate blade

FM 169.19
Eğri/Curved
Hassas bleyd
Delicate blade

FM 169.09-FM 169.19
16.5 cm

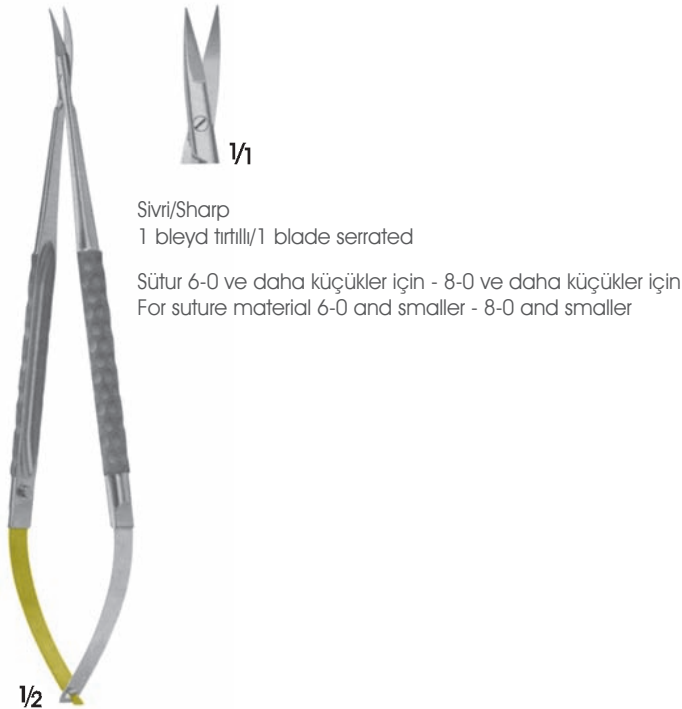

Sivri/Sharp
1 bleyd tırtıllı/1 blade serrated

Sütür 6-0 ve daha küçükler için - 8-0 ve daha küçükler için
For suture material 6-0 and smaller - 8-0 and smaller

FD 149.00
Mikro ligatür makası
Micro ligature scissor
18 cm

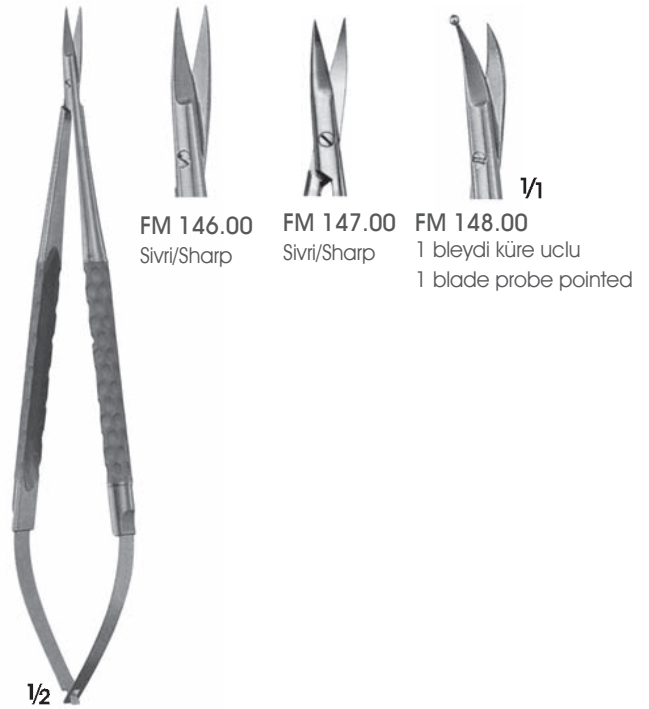

FM 146.00
Sivri/Sharp

FM 147.00
Sivri/Sharp

FM 148.00
1 bleydi küre uclu
1 blade probe pointed

FM 146.00-FM 148.00
Mikro makaslar
Micro scissors
18 cm



Düz Saplı ve Yuvarlak Saplı Mikro Makaslar
Micro Scissors with Flat Handle and Round Handle

25° 45° 60° 90° 125°

Ultra hassas bleyd
Ultra delicate blade



FM 168.00 FM 168.01 FM 168.03 FM 168.04 FM 168.06
FM 169.00 FM 169.01 FM 169.03 FM 169.04 FM 169.06

Hassas bleyd
Delicate blade



FM 168.10 FM 168.11 FM 168.13 FM 168.14 FM 168.16
FM 169.10 FM 169.11 FM 169.13 FM 169.14 FM 169.16

Ince bleyd,
tek tarafı küre uçlu bleyd
Fine blade,
with 1 probe pointed blade



FM 168.30 FM 168.31 FM 168.33 FM 168.34 FM 168.36
FM 169.30 FM 169.31 FM 169.33 FM 169.34 FM 169.36

Ince bleyd
Fine blade



FM 168.50 FM 168.51 FM 168.53 FM 168.54 FM 168.56
FM 169.50 FM 169.51 FM 169.53 FM 169.54 FM 169.56

Düz sap
Flat handle

Yuvarlak sap
Round handle



FM 168.00-FM 168.56 FM 169.00-FM 169.56
16.5 cm 16.5 cm

Kavrama yüzeyini artıran hafif plastik tutamak :

- Kramp oluşturmeyan, doğal tutma pozisyonu ve duyarlılık sağlar.
- Yuvarlak tutma kesiti aletin kolay ve düzgün rotasyonunu sağlar. Böylelikle uygulama ve çalışma alanı genişler.
- Pimli tutma profili güvenli tutmayı garanti eder.
- Ergonomik, hafif plastik sap yorulmadan optimum kullanım sağlar.

Lightweigh plastic handles to increase grip surface :

- Provides cramp free, natural holding positions and sensitivity
- Round cross-section of the instrument provides an easy and smooth rotation.Expands the working and application area.
- Retention profile with pin ensures safe griping.
- Ergonomic, light weight plastic handle provides fatigue free,optimal usage.





BC 228.00K
Düz/Straight

BC 229.00K
Eğri/Curved

1/2

BC 228.00K-BC 229.00K
Hassas makaslar/Delicate scissors
11.5 cm

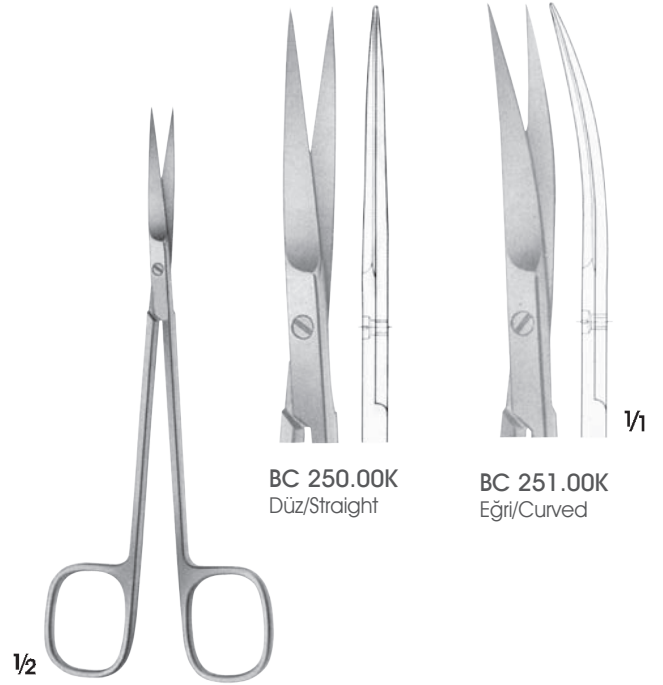

BC 250.00K
Düz/Straight

BC 251.00K
Eğri/Curved

1/2

JOSEP
BC 250.00K-BC 251.00K
Hassas makaslar/Delicate scissors
15 cm

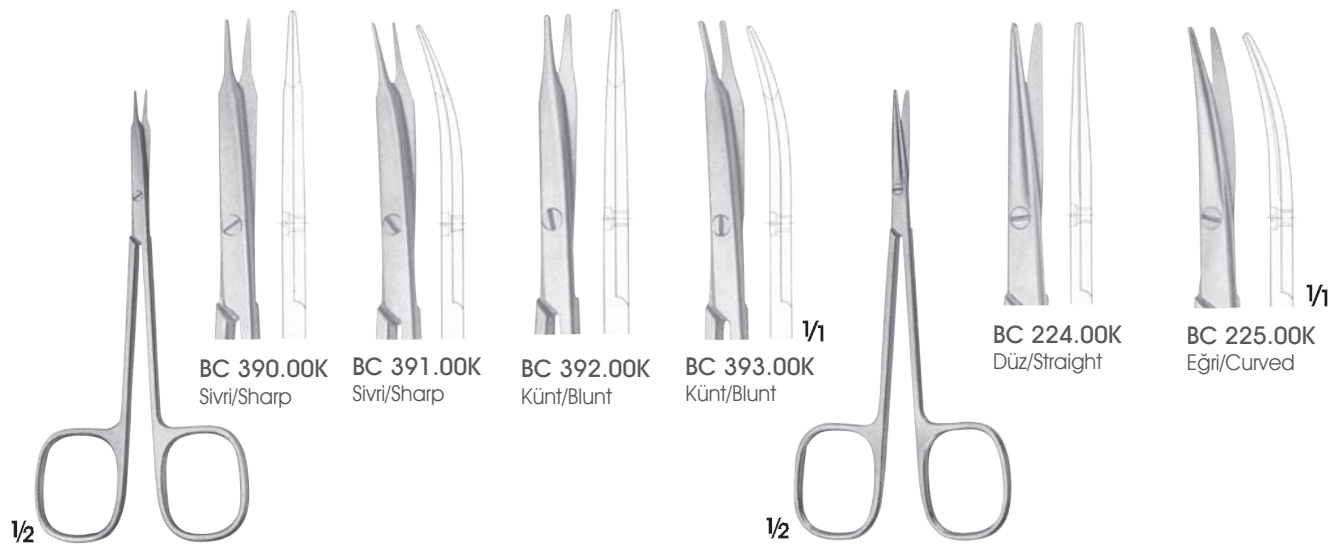

BC 390.00K
Sivri/Sharp

BC 391.00K
Sivri/Sharp

BC 392.00K
Künt/Blunt

BC 393.00K
Künt/Blunt

BC 224.00K
Düz/Straight

BC 225.00K
Eğri/Curved

1/2

STVENS
BC 390.00K-BC 393.00K
Diseksiyon makasları/Dissecting scissors
11.5 cm

1/2

BC 224.00K-BC 225.00K
Diseksiyon ve şaşılık makasları
Dissecting- and strabismus scissors
11.5 cm

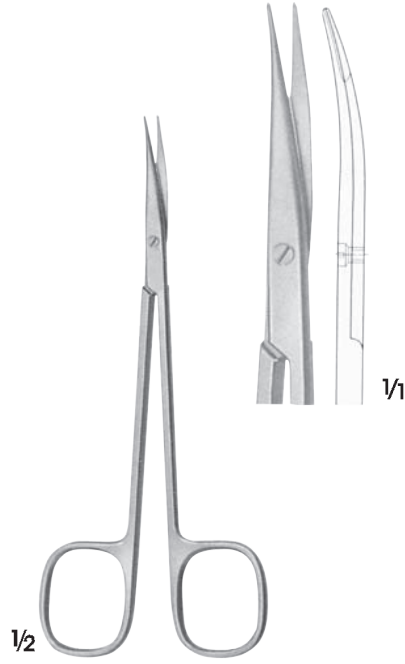

REYNOLDS-JAMESON
BC 386.00K
Vasküler makas/Vascular scissors
14 cm



METZENBAUM
BC 412.00K-BC 413.00K
Diseksiyon makasları/Dissecting scissors
14.5 cm

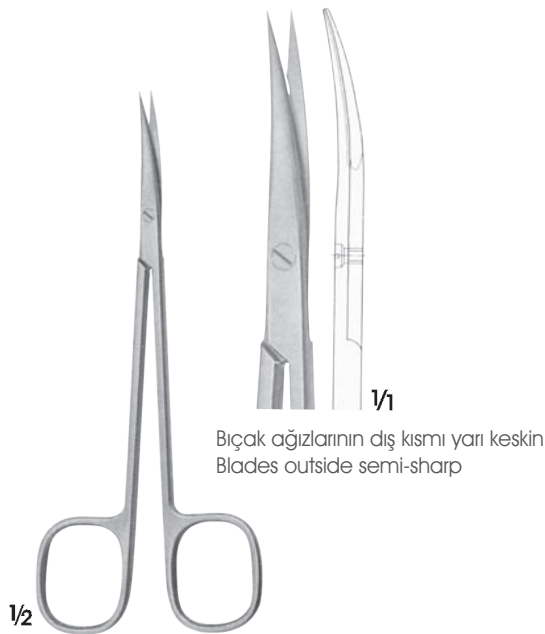

BC 258.00K Diseksiyon,
sinir makası Nerve
dissecting scissors 14 cm



RAGNELL
BC 398.00K-BC 398.11K
Diseksiyon ve cilt altı için özel düz uçlar
Special flat points for dissecting and
undermining the skin



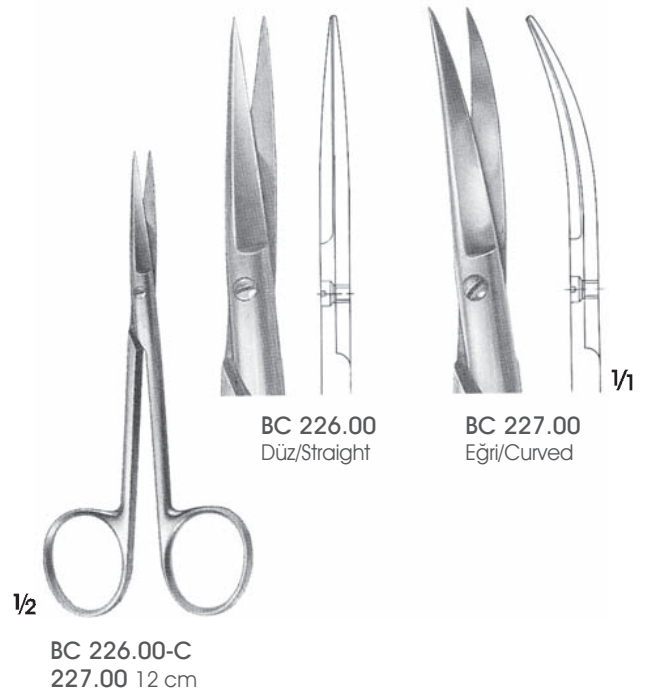



BC 230.00
Sivri/Sharp

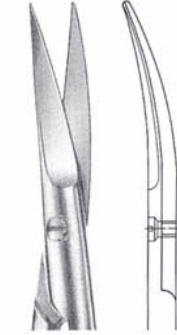

BC 231.00
Sivri/Sharp

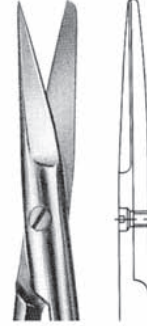

BC 232.00
Sivri/Sharp
Künt/Blunt

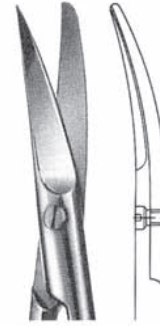

BC 233.00
Sivri/Sharp
Künt/Blunt

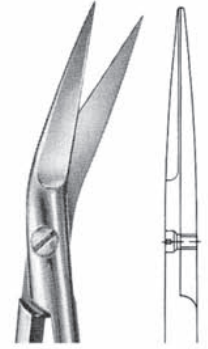

BC 234.00
Sivri/Sharp
Yan Eğri
Curved to side

1/1

BC 230.00-C
234.00 11 cm



BC 230.01
Düz/Straight

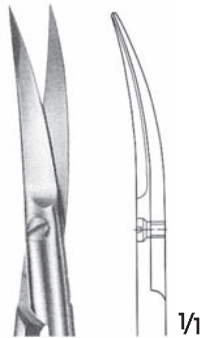

BC 231.01
Eğri/Curved

1/1



OL 235.00
Düz/Straight

OL 236.00
Eğri/Curved

1/1

OL 235.00-C
236.00 12 cm



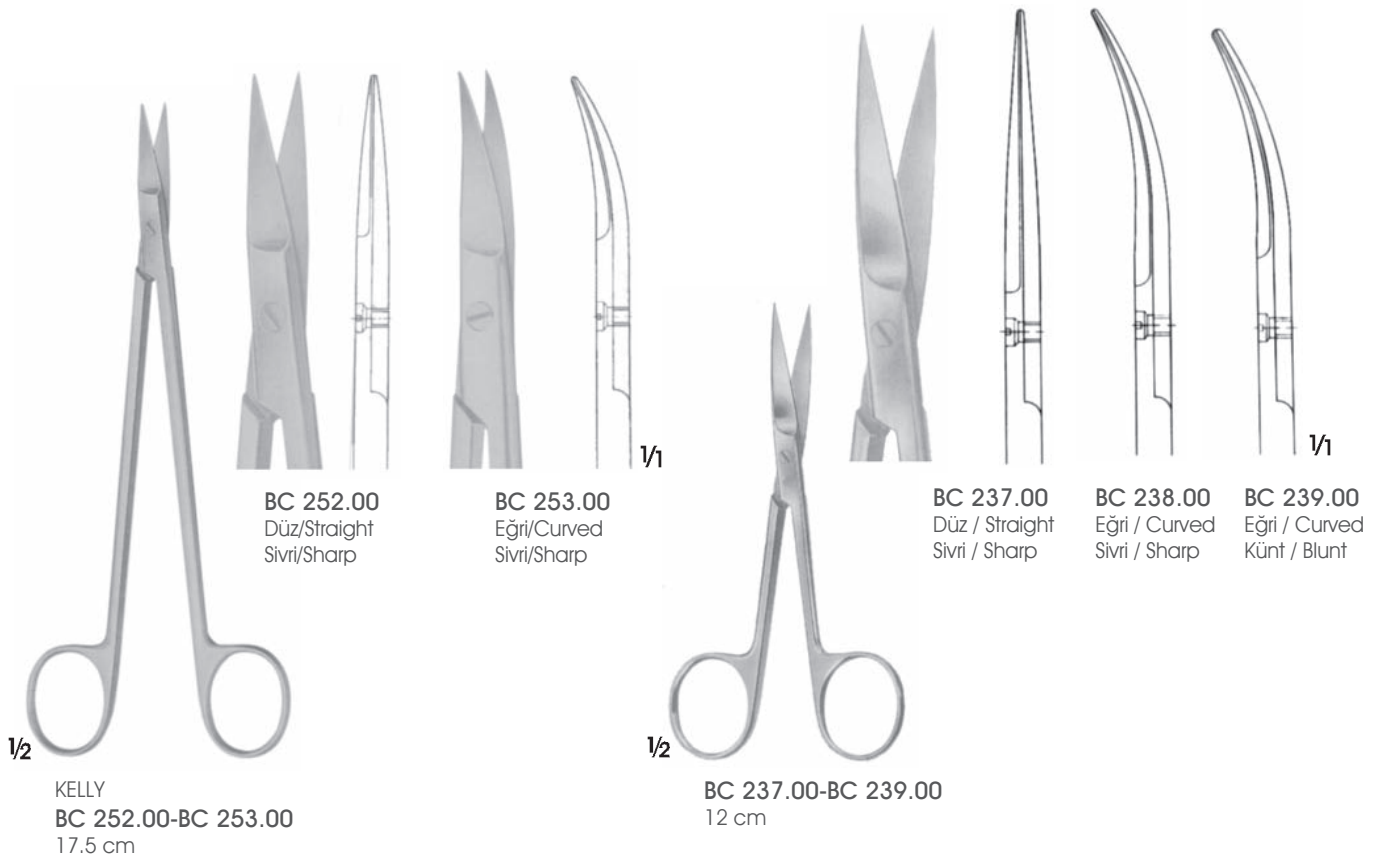



CHADWICK
BC 260.00
11.5 cm

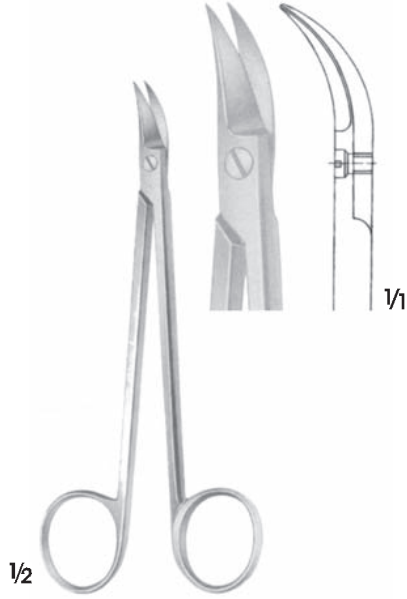

QUINBY
BC 261.00
13 cm

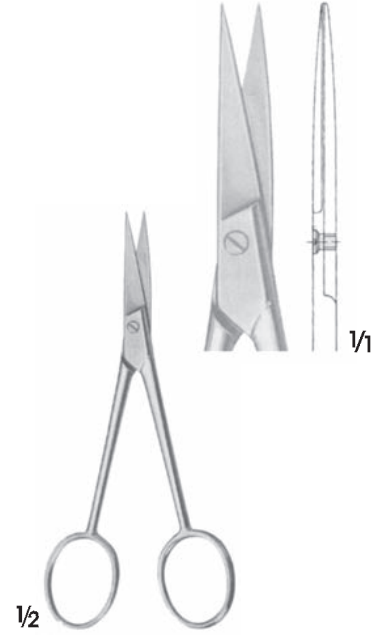

BC 264.00
11 cm

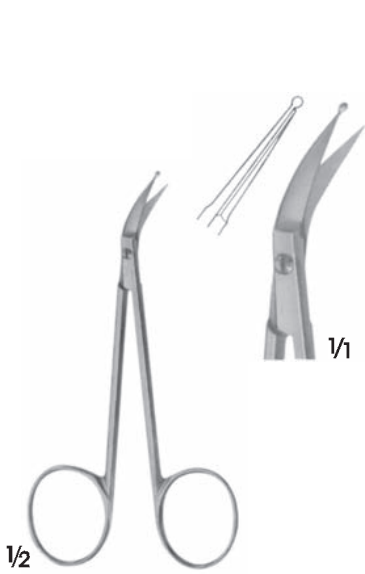

PERWITZSCHKY
OM 522.00
1 bleydi küre uclu eğri,
With 1 probe pointed blade, curved to side
10 cm

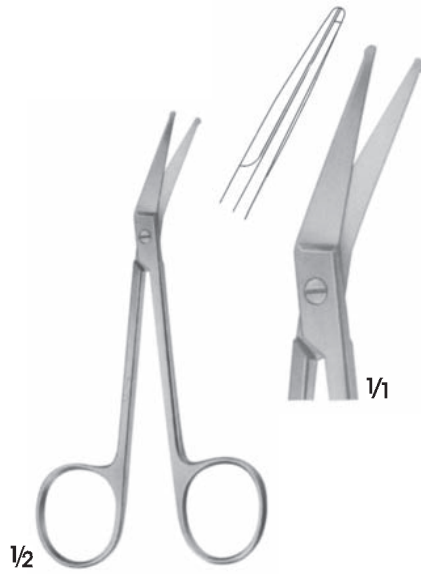

BC 523.00
Yana doğru açılı
Angled to side
11.5 cm

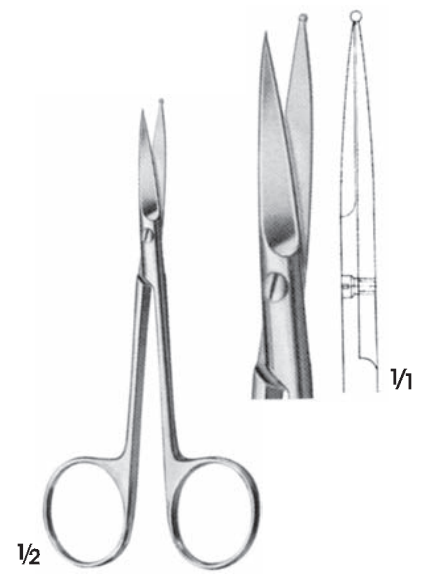

BC 540.00
1 bleydi küre uclu
With 1 probe pointed blade
12 cm



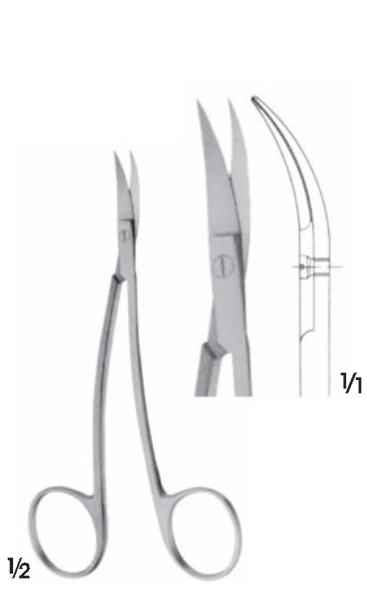

LA GRANGE
BC 532.00
Tek ağız tırıklı
One jaw serrated
11 cm



DO 533.00
Tek ağız tırıklı, yana açılı
Angled on flat, one jaw serrated
12.5 cm

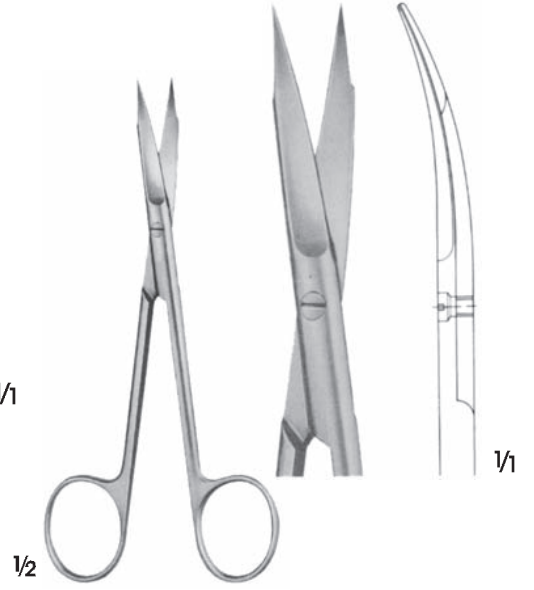

DO 534.00
Tek ağız tırıklı, hassas
One jaw fine serrated
13 cm

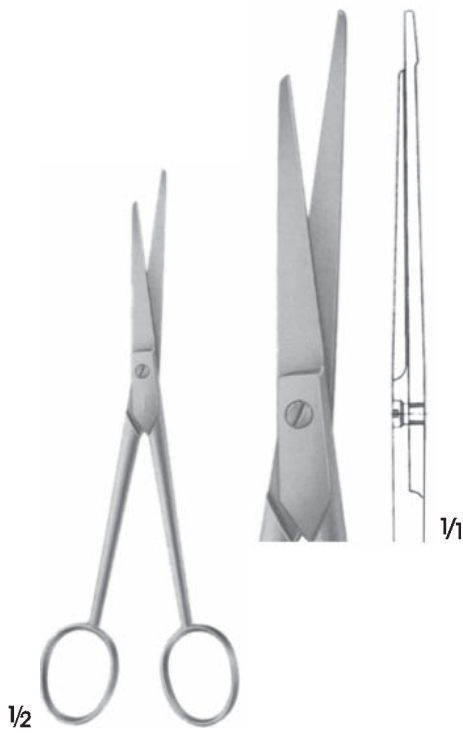

BC 542.00
1 ucu problu
With 1 probe pointed blade
14.5 cm



LOCKLIN
DO 546.00
Tek ağız tırıklı, yana açılı
Angled to side, one jaw serrated
15.5 cm

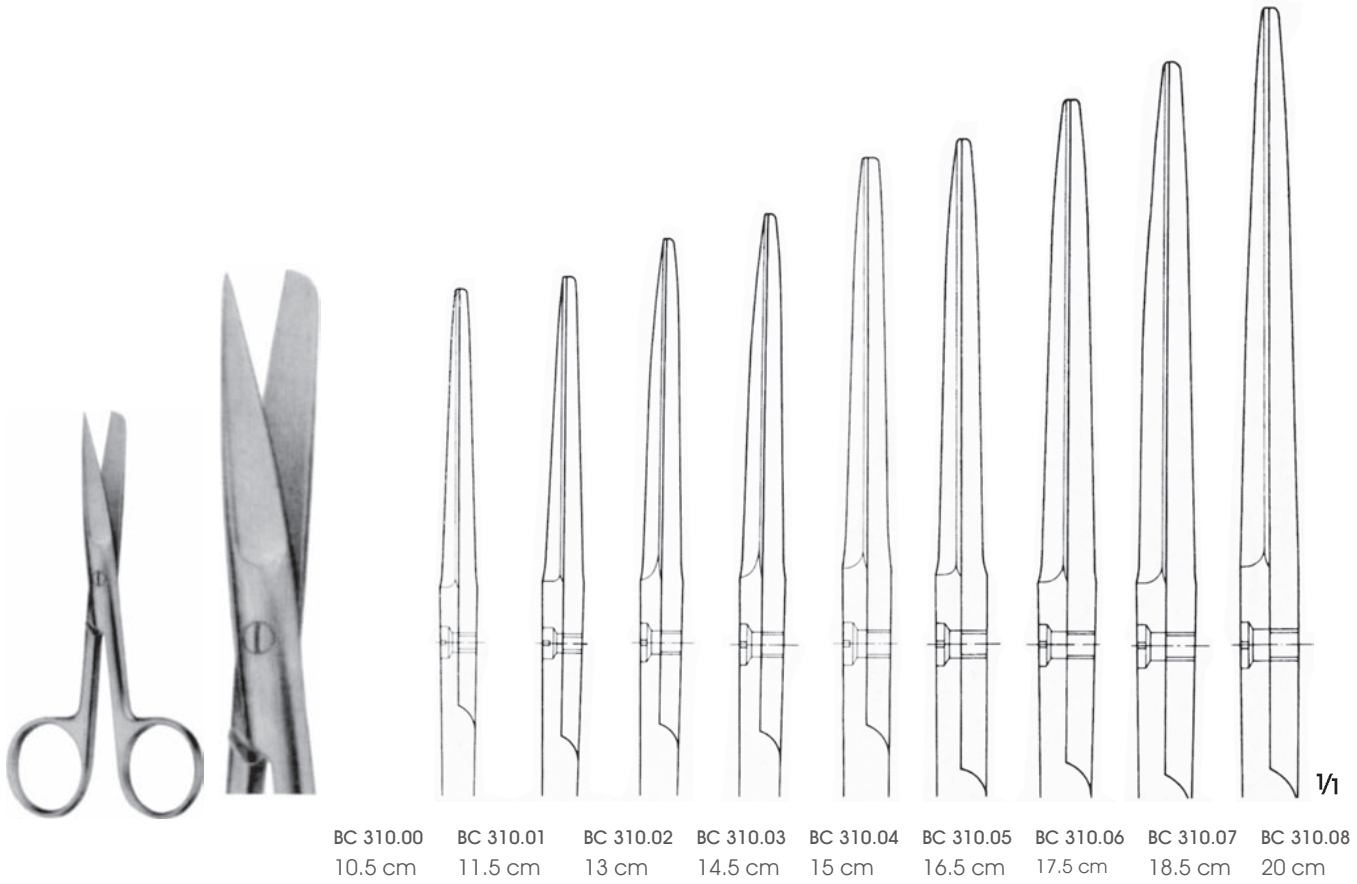

BC 310.00-BC 310.08
Standart model/Standart patterns
Sivri-Künt/Sharp-Blunt
Düz/Straight

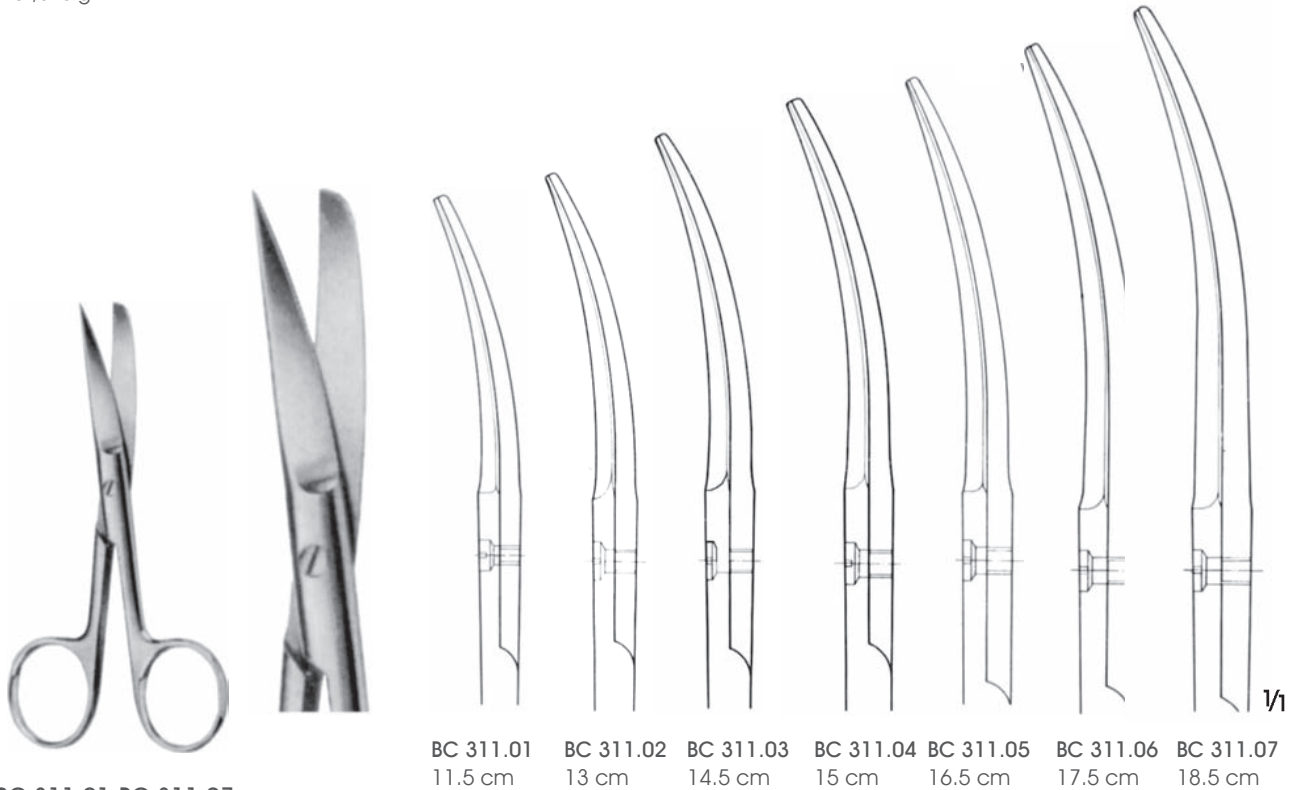

BC 311.01-BC 311.07
Standart model/Standart patterns
Sivri-Künt/Sharp-Blunt
Eğri/ Curved

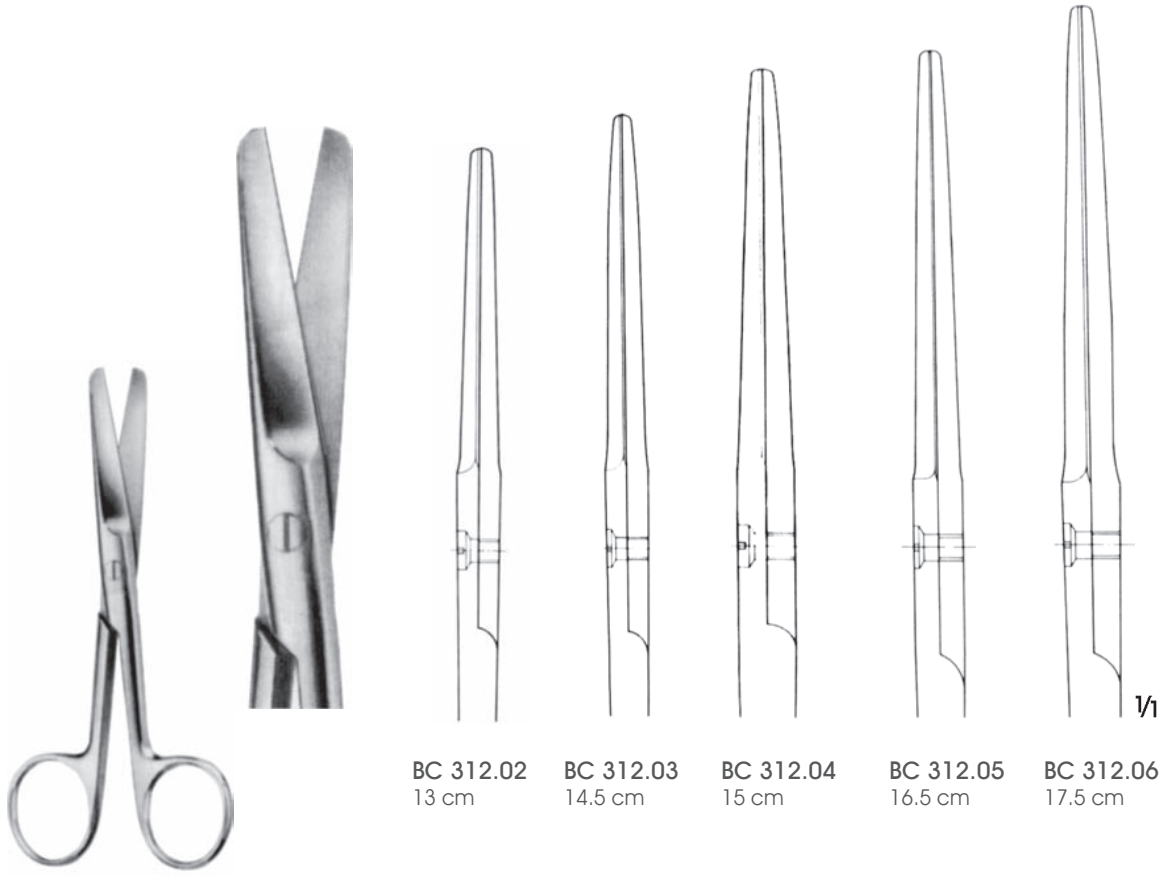

BC 312.02-BC 312.06
Standart model/Standart patterns
Künt/Blunt
Düz/Straight

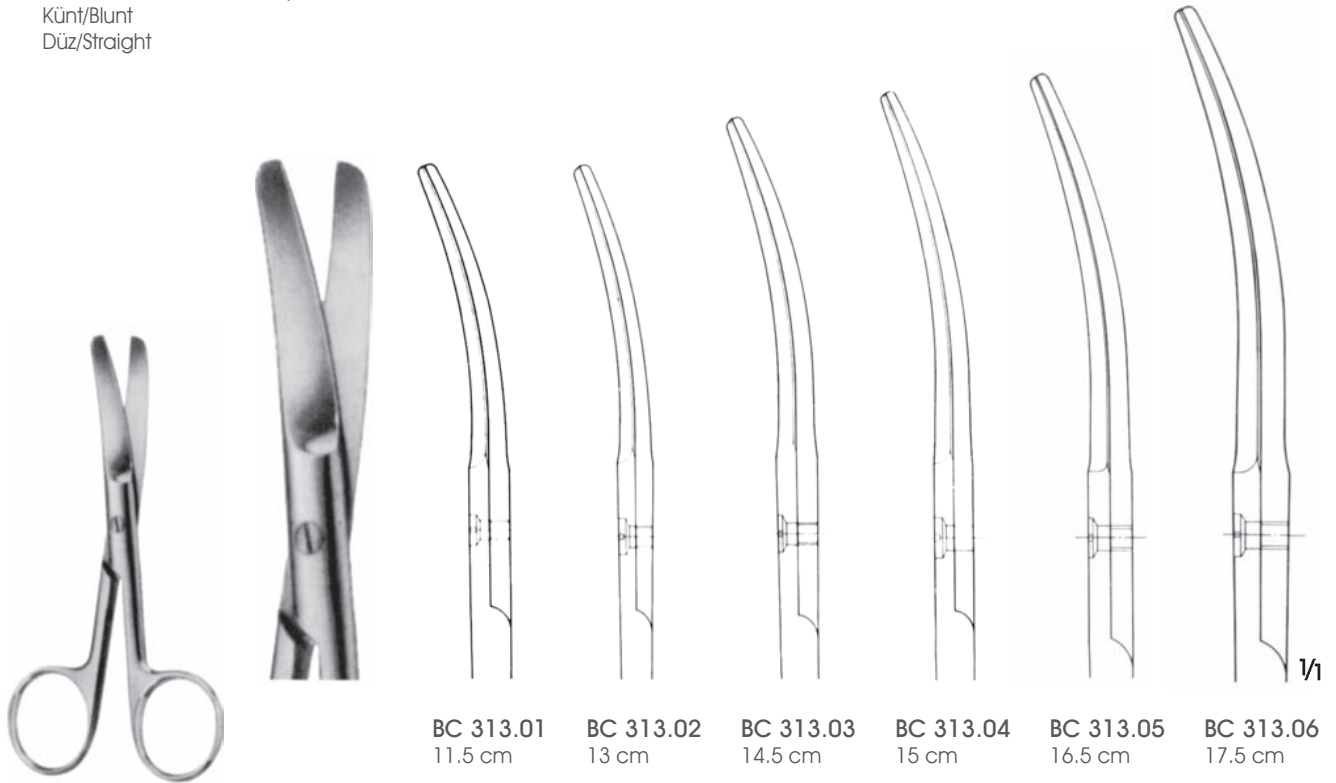

COOPER
BC 313.01-BC 313.06
Standart model/Standart patterns
Künt/Blunt
Eğri/Curved



BC 314.01-BC 314.05
Standart model/Standart patterns
Sivri/Sharp
Düz/Straight

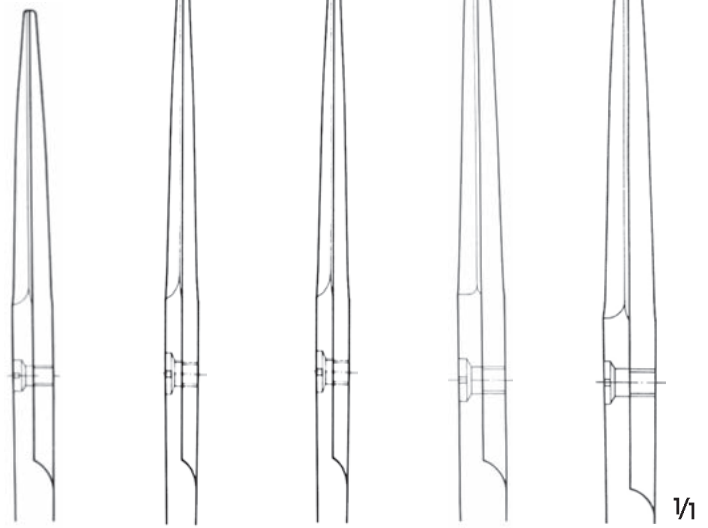

BC 314.01 11.5 cm
BC 314.02 13 cm
BC 314.03 14.5 cm
BC 314.04 15 cm
BC 314.05 16,5 cm



BC 315.01-BC 315.04
Standart model/Standart patterns
Sivri/Sharp
Eğri/Curved

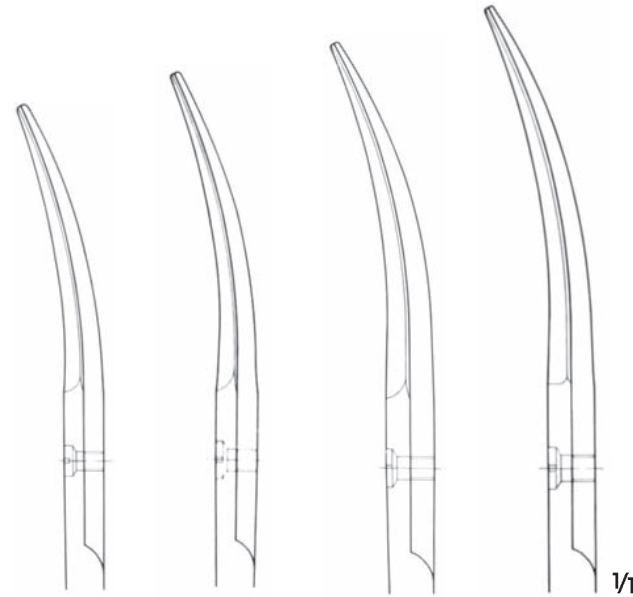

BC 315.01 11.5 cm
BC 315.02 13 cm
BC 315.03 14.5 cm
BC 315.04 15 cm

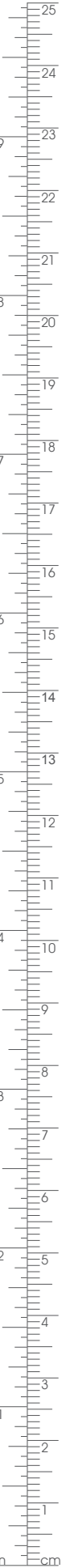

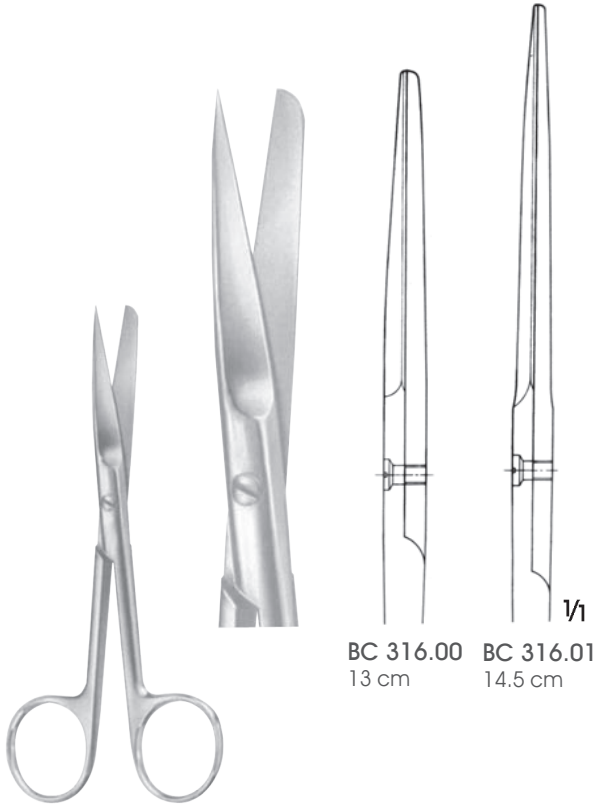

BC 316.00-BC 316.01
Narin model/Slender patterns
Sivri-Küntt/Sharp-Blunt
Düz/Straight



BC 317.00-BC 317.01
Narin model/Slender patterns
Sivri-Küntt/Sharp-Blunt
Eğri/Curved

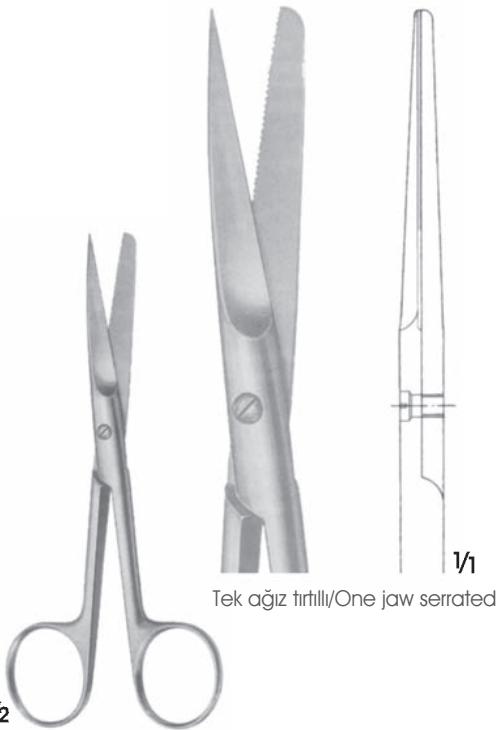

BC 318.00
Yara kenar makası/Scissors for wound edges
Sivri-Küntt/Sharp-Blunt
Düz/Straight
13 cm

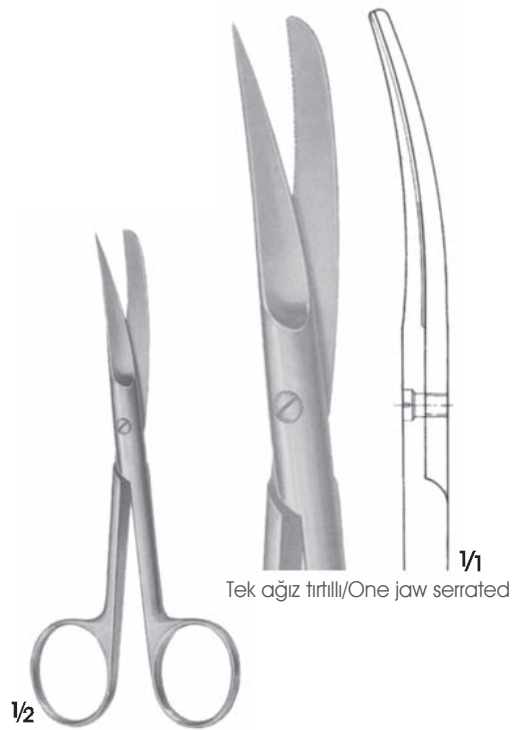

BC 319.01
Yara kenar makası/Scissors for wound edges
Sivri-Küntt/Sharp-Blunt
Eğri/Curved
13 cm

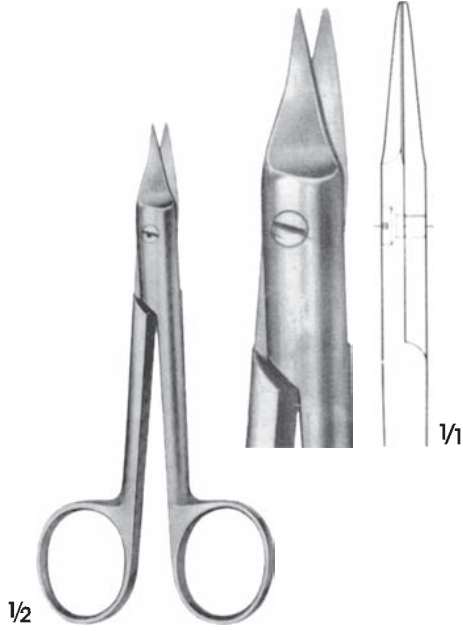

$\frac{1}{2}$
SYSTRUNK
BC 660.00
Sert doku makası/Nail splitting scissors
13 cm

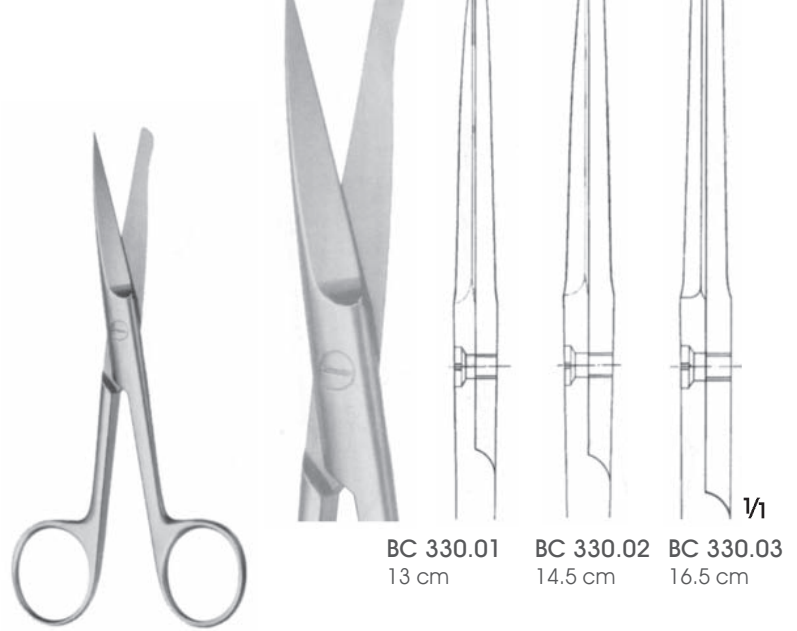

BC 330.01-BC 330.03
Inzisyon makasları/Incision scissors
Düz/ Straight

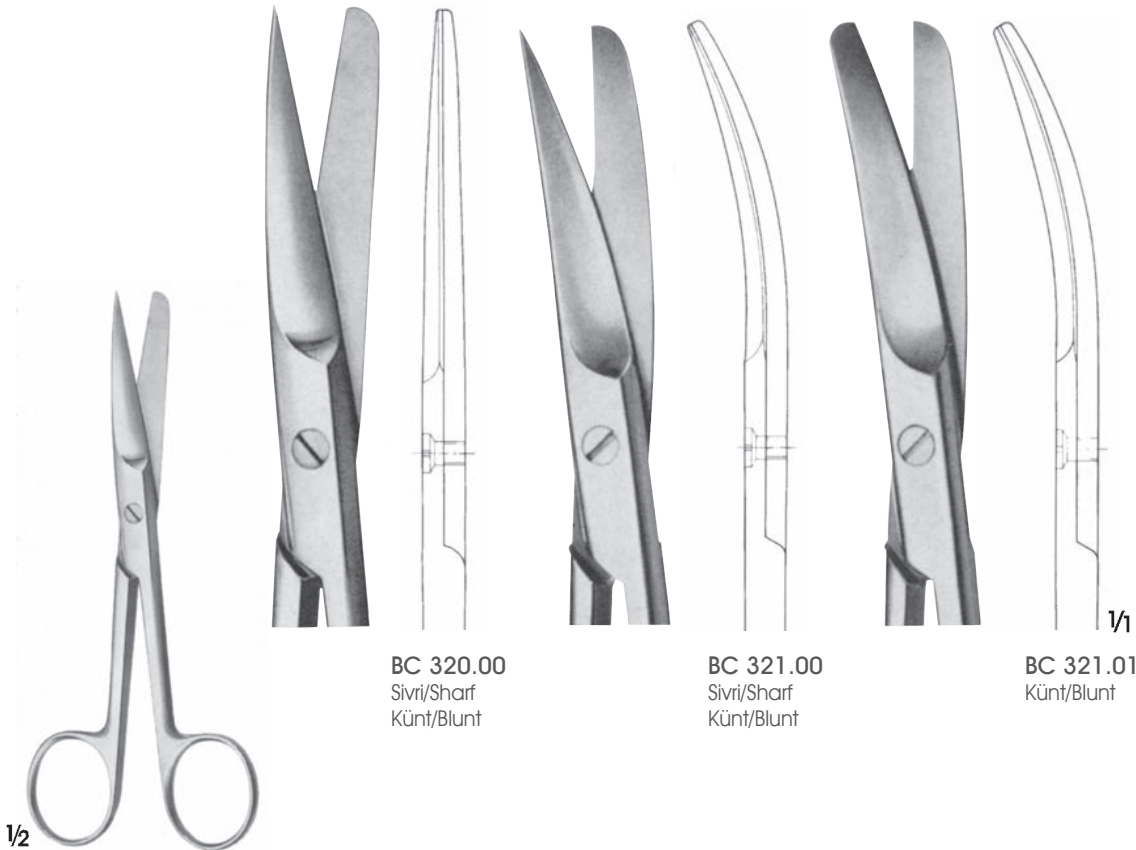

$\frac{1}{2}$
DEAVER
BC 320.00-BC 321.01
Cerrahi makaslar/Surgical scissors
14.5 cm





GRAEFE
OC 360.00 Künt/Blunt
Diseksiyon makası/Dissecting scissors
10 cm



BC 365.00 Düz/Straight
BC 366.00 Eğri/Curved
Diseksiyon makasları
Dissecting scissors 11.5
cm



COTTLE
OC 368.00
Bulldog makası/Bulldog scissors
11.5 cm



LITTLER
BC 380.00
Diseksiyon makası ip kesici, delikli
Dissecting scissors, tips with eye suture
11.5 cm

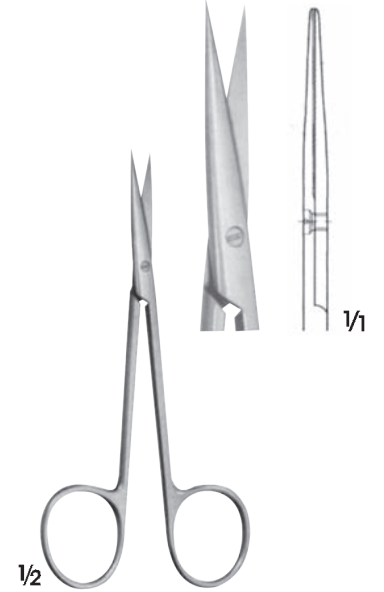

KILNER
BC 224.00
Hassas diseksiyon makası
Delicate dissecting scissors
11.5 cm

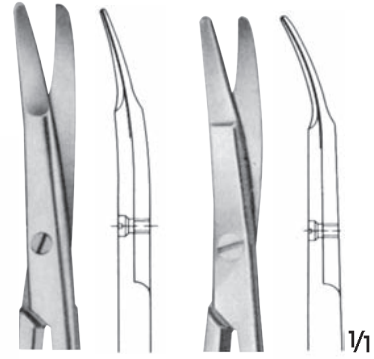
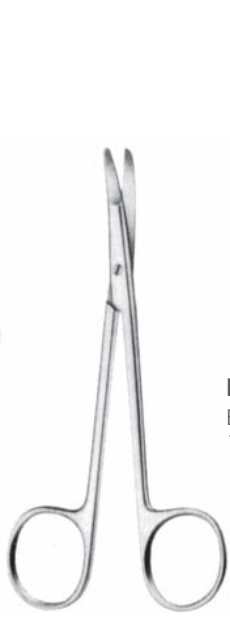

BC 382.00
Eğri/Curved
12.5 cm

BC 382.01
Eğri/Curved
15 cm

KILNER

BC 382.00-BC 382.01

Diseksiyon ve cilt altı için özel düz uçlar
Special flat points for dissecting and
undermining the skin

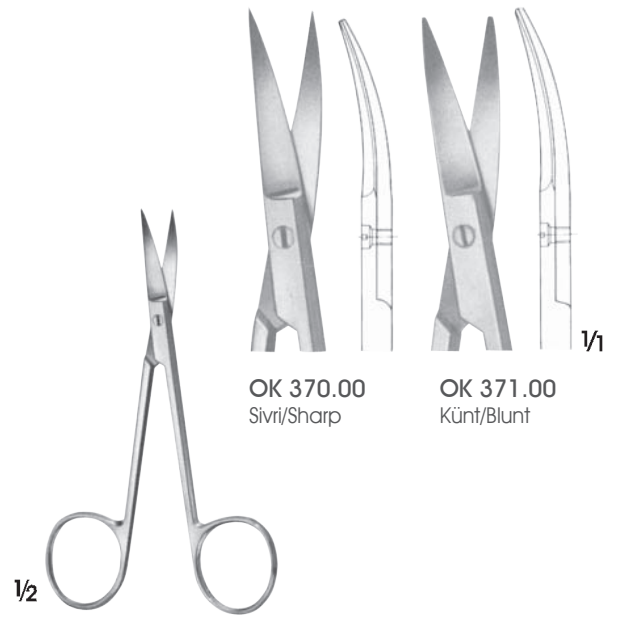

OK 370.00
Sivri/Sharp

OK 371.00
Künt/Blunt

COTTLE-MASING

OK 370.00-OK 371.00

Plastik cerrahi makasları
Scissors for plastic surgery
10.5 cm



OK 265.00
Eğri/Curved
11.5 cm

OK 266.00
Eğri/Curved
13.5 cm

FOMON

OK 265.00-OK 266.00

Alt yanıl makaslar Lower
lateral scissors

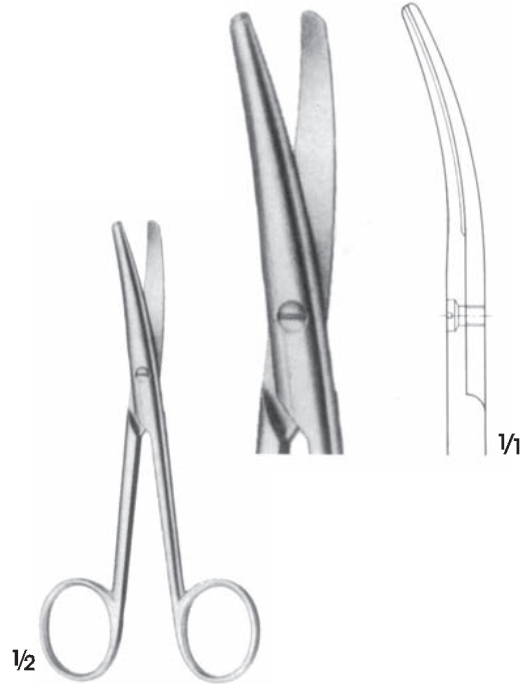

LANDOLT

OC 268.00

Enuklasyon makası
Enucleation scissors
12 cm



fineCut



BC 396.00
Düz/Straight

BC 396.10
Eğri/Curved

STEVENS
BC 396.00-BC 396.10
Damar ve tendon makasları
Vascular and tendon scissors
10 cm

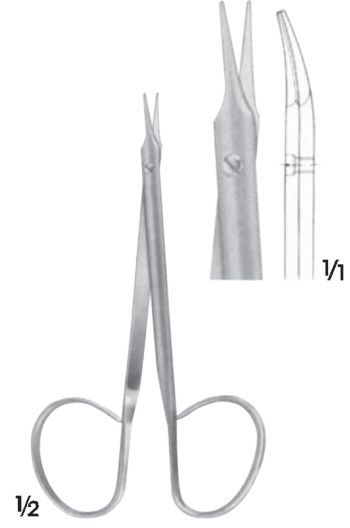

STEVENS
OK 397.00
Hassas diseksiyon makası
Delicate dissecting scissors
11 cm

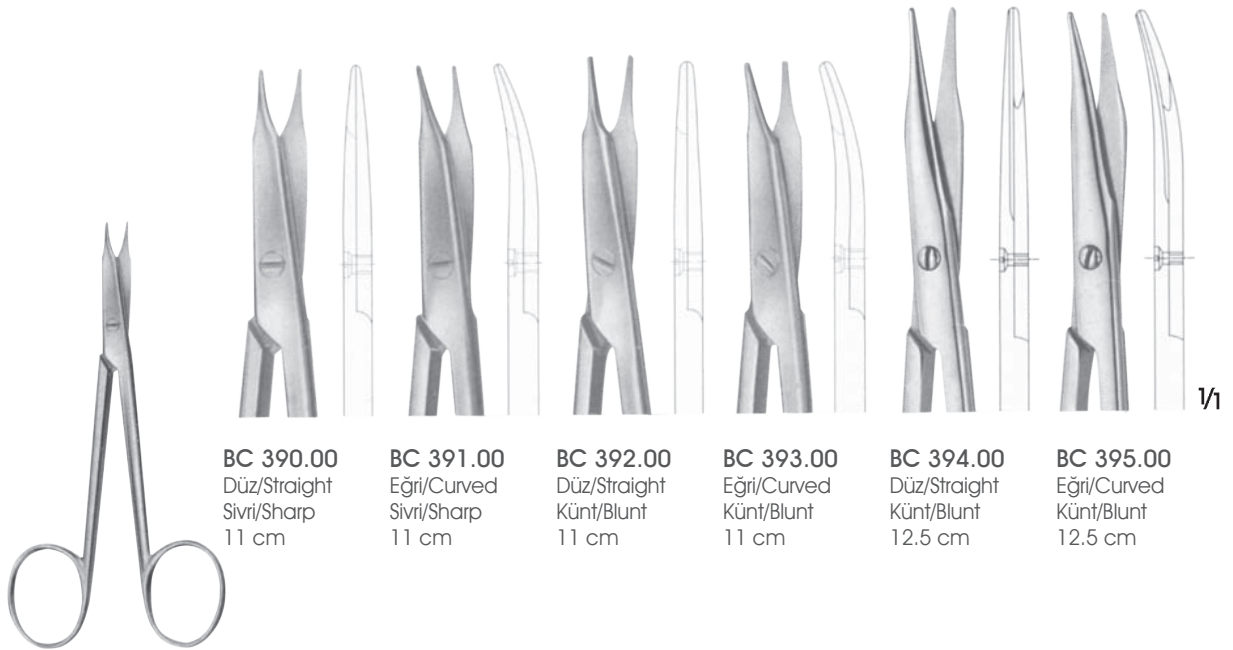

BC 390.00
Düz/Straight
Sivri/Sharp
11 cm

BC 391.00
Eğri/Curved
Sivri/Sharp
11 cm

BC 392.00
Düz/Straight
Künt/Blunt
11 cm

BC 393.00
Eğri/Curved
Künt/Blunt
11 cm

BC 394.00
Düz/Straight
Künt/Blunt
12.5 cm

BC 395.00
Eğri/Curved
Künt/Blunt
12.5 cm

STEVENS
BC 390.00-BC 395.00
Damar ve tendon makasları
Vascular and tendon scissors

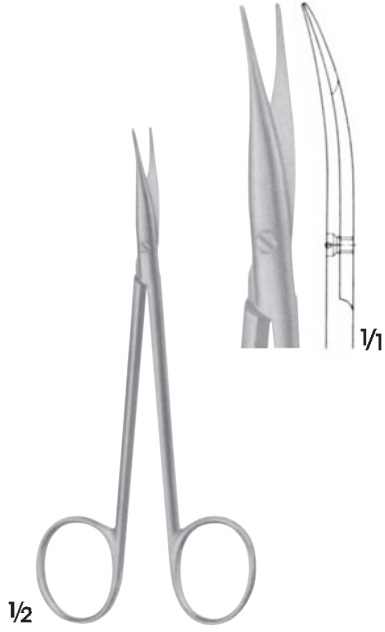

JAMESON-WERBER
BC 385.00
Diseksiyon makası
Dissecting scissors
13 cm



JAMESON
BC 386.00
Diseksiyon makası
Dissecting scissors
15 cm

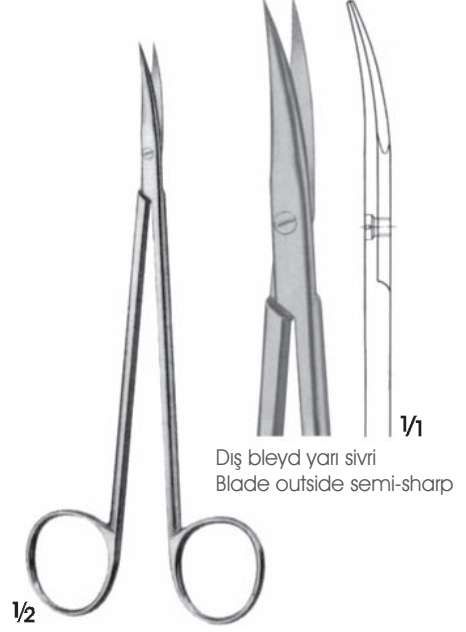

BC 258.00
Sinir, diseksiyon makası
Nerve dissecting scissors
15 cm

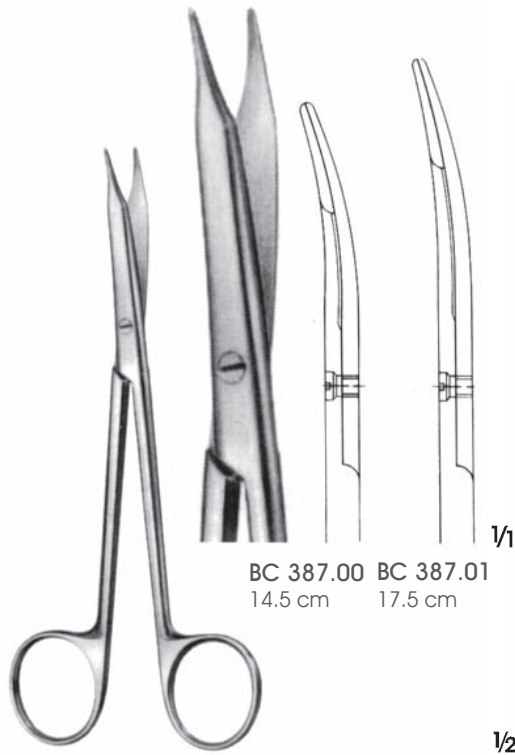

REYNOLDS
BC 387.00-BC 387.01
Diseksiyon makasları Dissecting
scissors

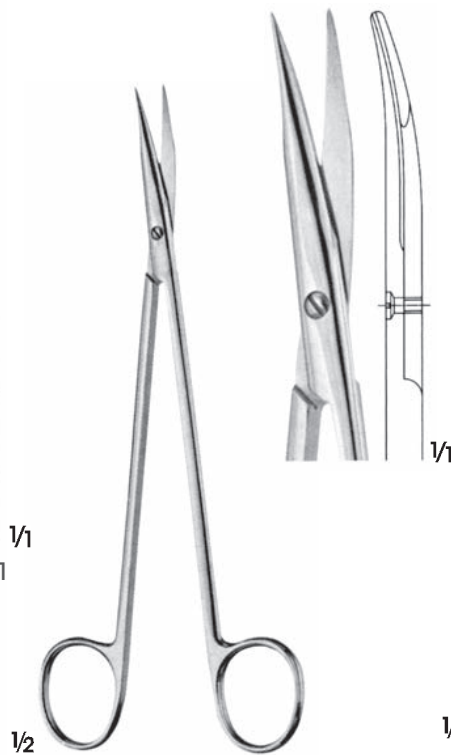

POTTS
BC 384.00
Diseksiyon makası
Dissecting scissors
18 cm

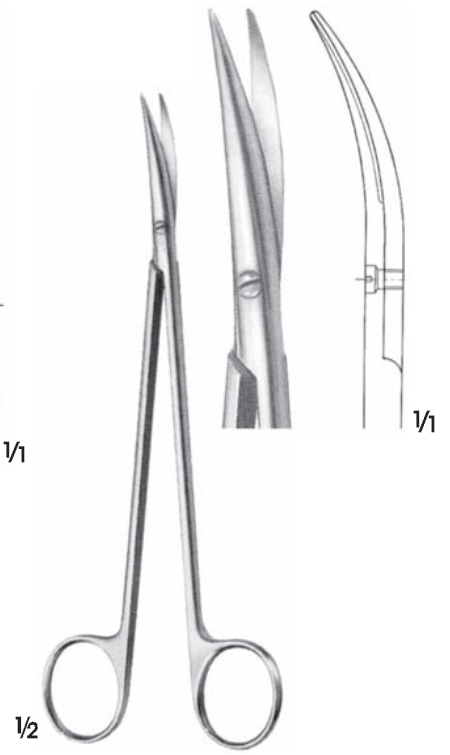

DE BAKEY
BC 415.00
Arteriyotomi makası
Arteriotomy scissors
17.5 cm

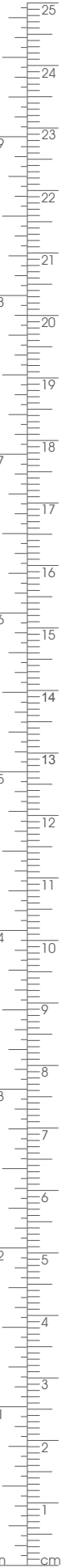



COTTLE-KNAPP
OK 410.00-OK 411.00
Plastik cerrahi makaslar
Scissors for plastic surgery
10.5 cm

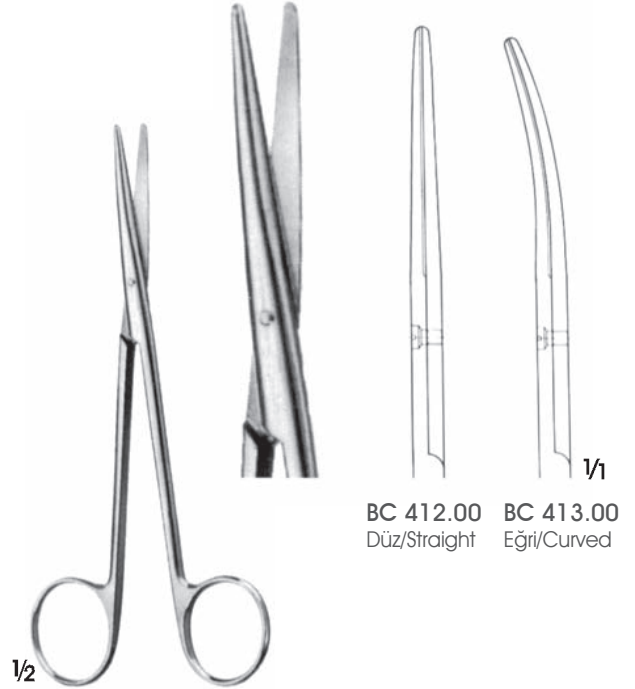

BABY-METZENBAUM
BC 412.00-BC 413.00
Diseksiyon makasları
Dissecting scissors 14.5
cm



METZENBAUM
BC 414.00-BC 414.05
Diseksiyon makasları
Dissecting scissors



TÖNNIS-ADSON
BC 416.00-BC 416.01
Diseksiyon makasları
Dissecting scissors 17.5
cm

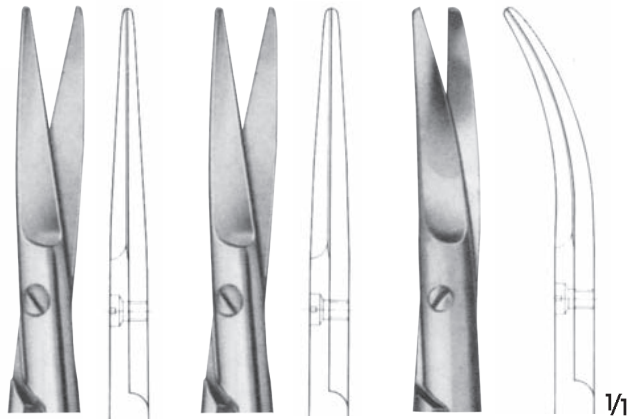
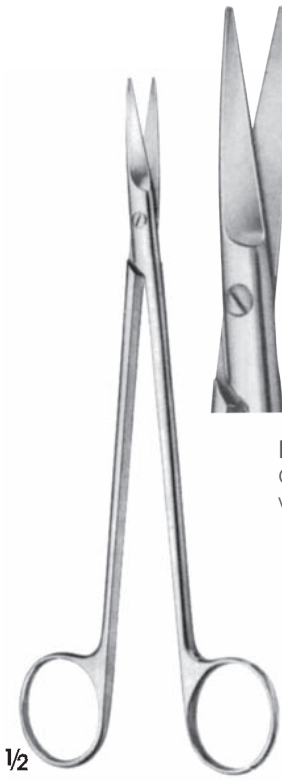

BC 418.00
Çok hassas
Very delicate

BC 418.01
Hassas
Delicate

BC 419.00
Hassas
Delicate

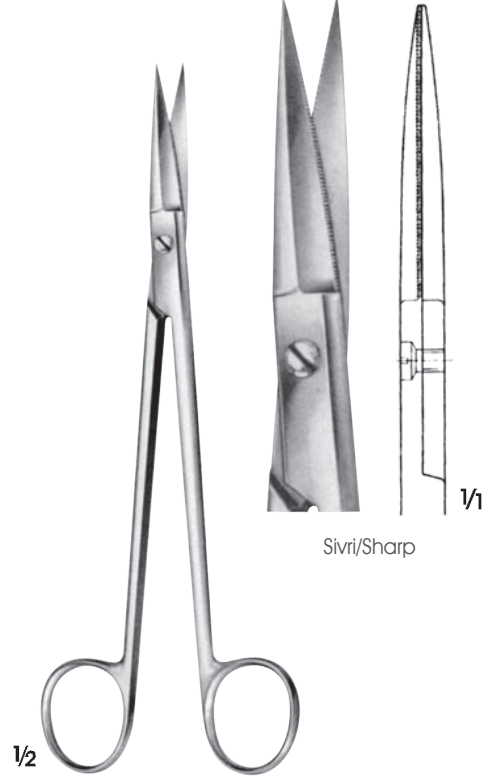

Sivri/Sharp

BC 435.00
Kıkırdak makası, çift ağız tırtıllı
Cartilage scissors, blades
cutting on both sides
18.5 cm

TÖNNIS
BC 418.00-BC 419.00
Diseksiyon makasları
Dissecting scissors
18 cm



Bleyd : Dış taraflar yarı keski
İç taraflar ince tırtıllı
Blade : Outside semi-sharp
Inside fine serrated

GORNEY
BC 430.00
Diseksiyon makası plastik cerrahi için
Dissection scissor for plastic surgery
12.5 cm

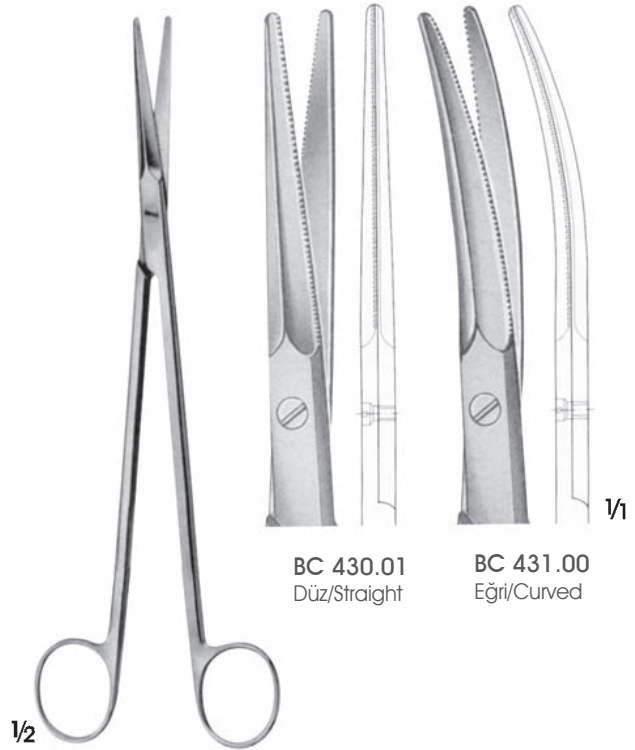

BC 430.01
Düz/Straight

BC 431.00
Eğri/Curved

GORNEY
BC 430.01-BC 431.00
Diseksiyon makaları plastik cerrahi için
Dissection scissors for plastic surgery
19.5 cm

Bleydler : Dış taraflar yarı keski
İç taraflar ince tırtıllı
Blades : Outside semi-sharp
Inside fine serrated



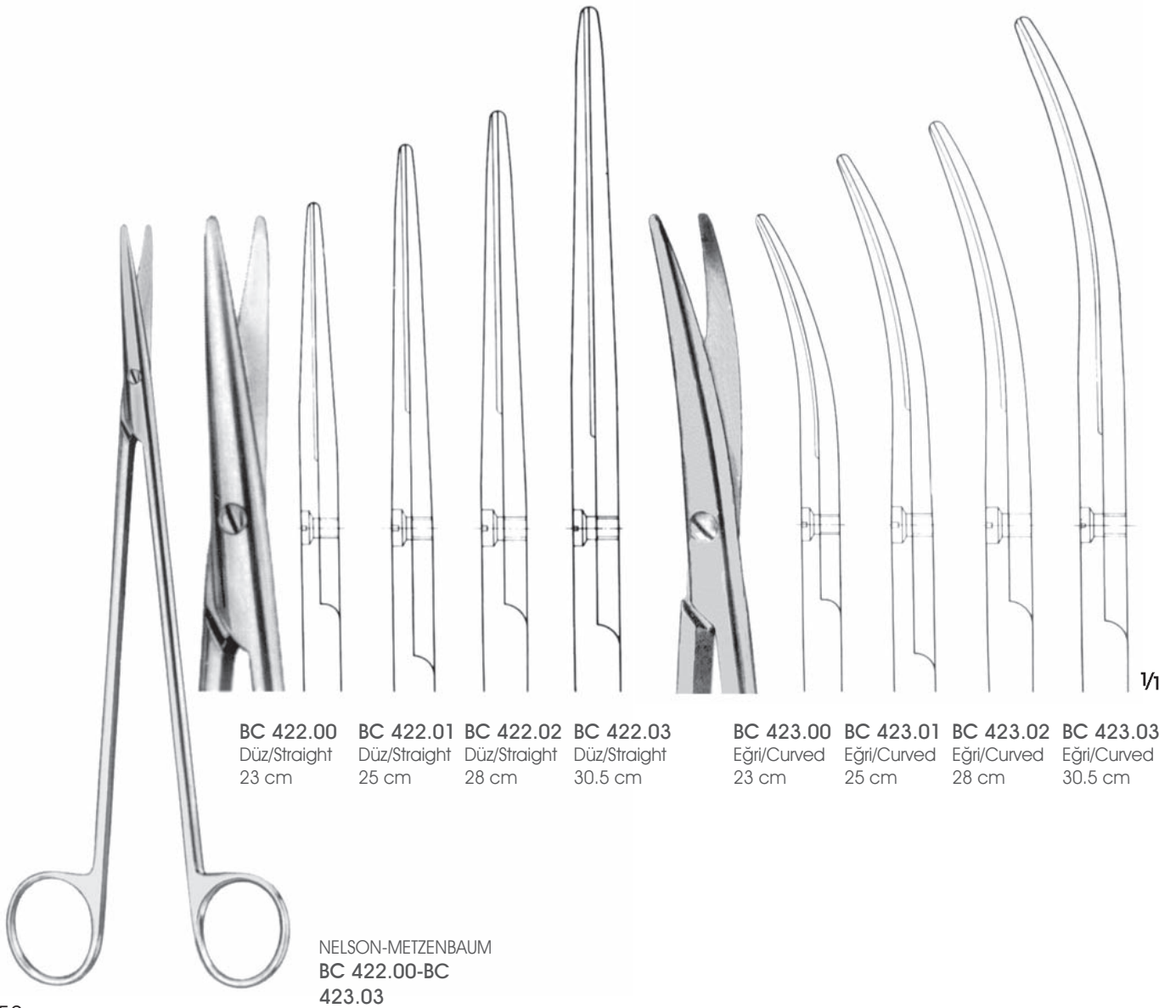
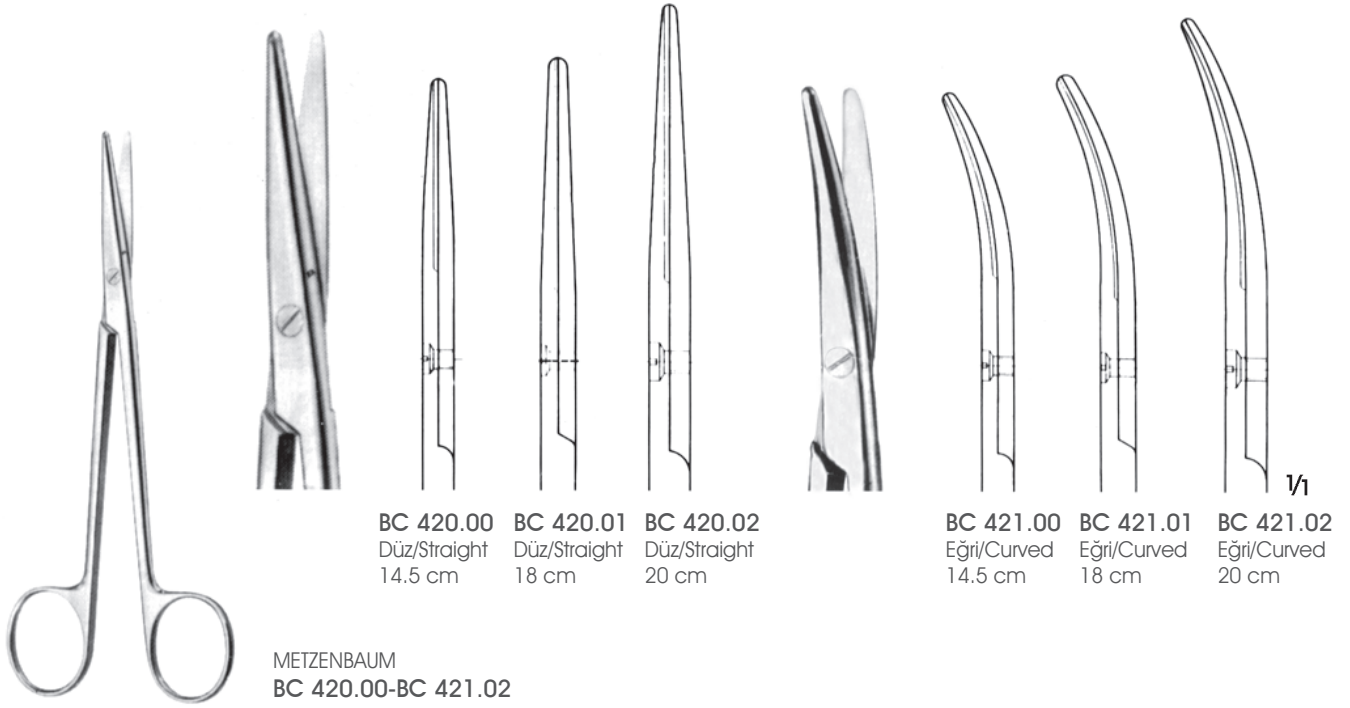



MAYO-STILLE
BC 446.00-BC 447.01
Uc kısmı oyuk yapraklı With
chamfered blades



BC 446.00
14 cm



BC 446.01
17 cm



BC 447.00
14 cm



BC 447.01
17 cm

1/1



MAYO
BC 449.00-BC 450.01
Uc kısmı oyuk yapraklı With
chamfered blades



BC 449.00
19 cm



BC 449.01
21.5 cm



BC 450.00
19 cm



BC 450.01
21.5 cm

1/1

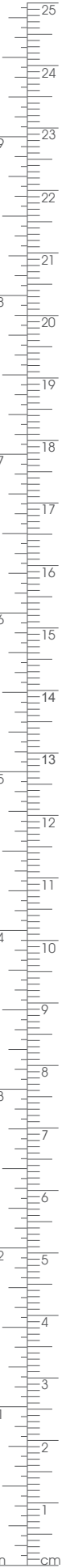

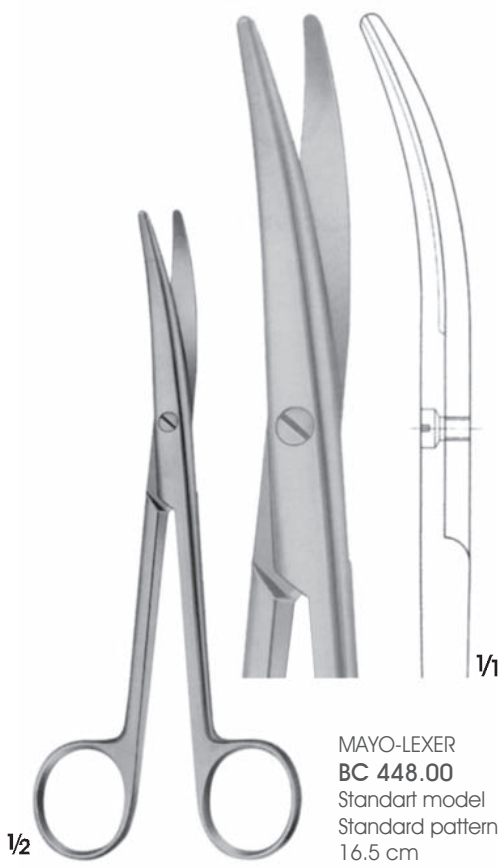
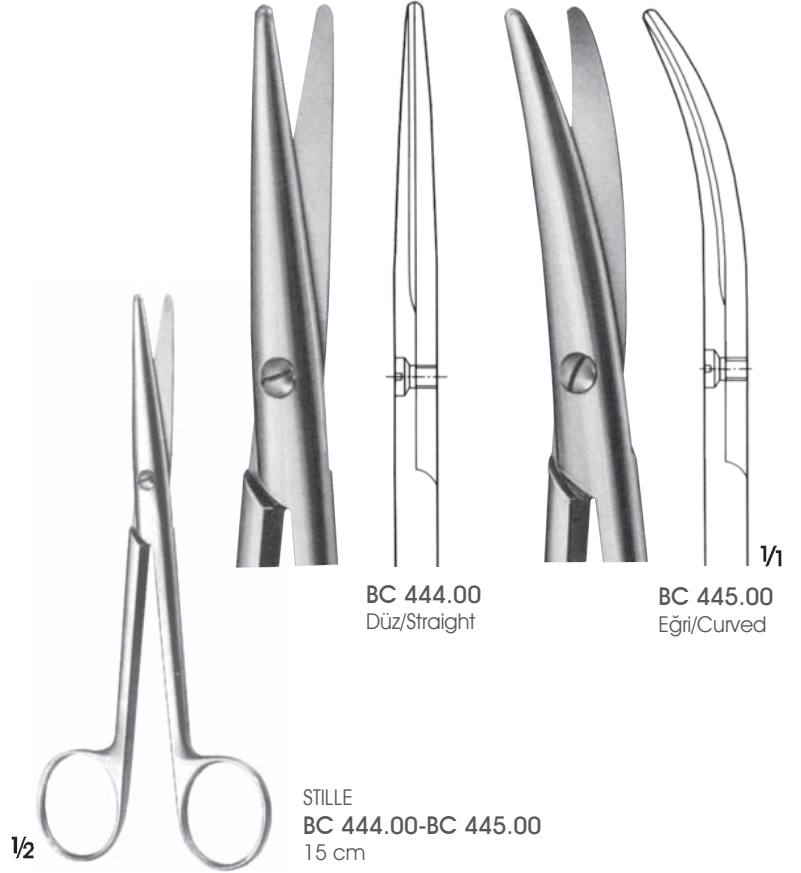
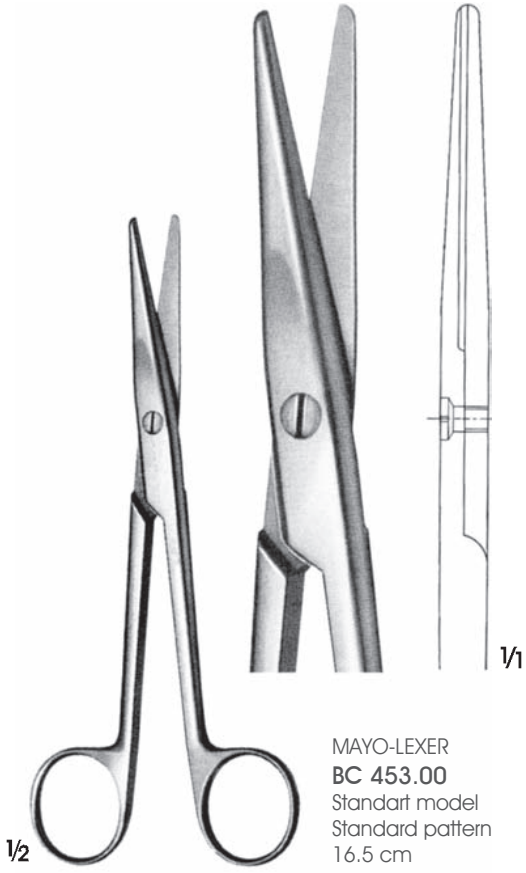

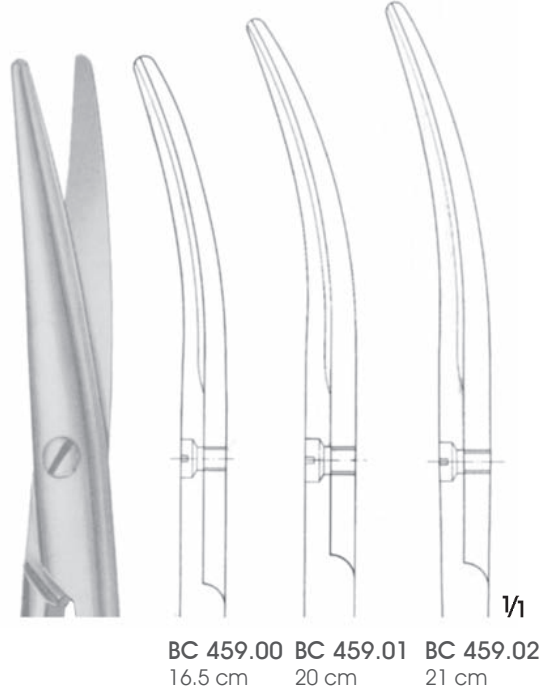
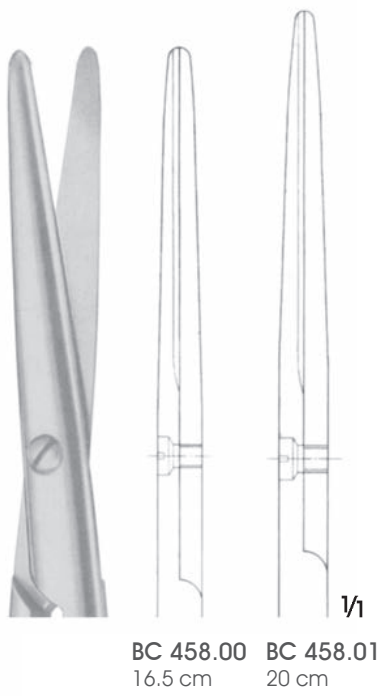

MAYO
BC 458.00-BC 459.02

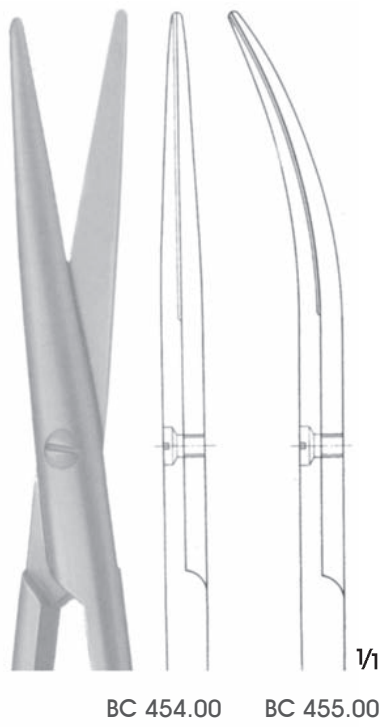

LEXER
BC 454.00-BC 455.00
Dar makaslar
Narrow scissors
16.5 cm

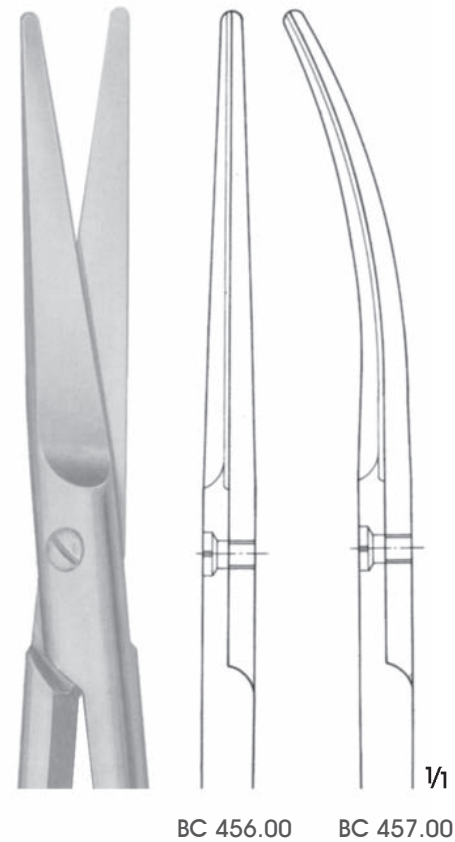

MAYO-HARRINGTON
BC 456.00-BC 457.00
23 cm

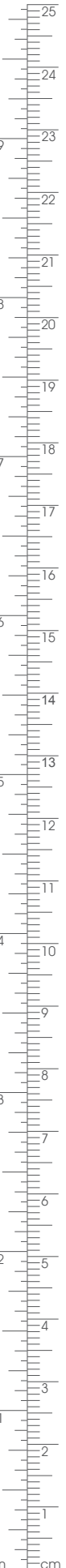

1/2

1/2

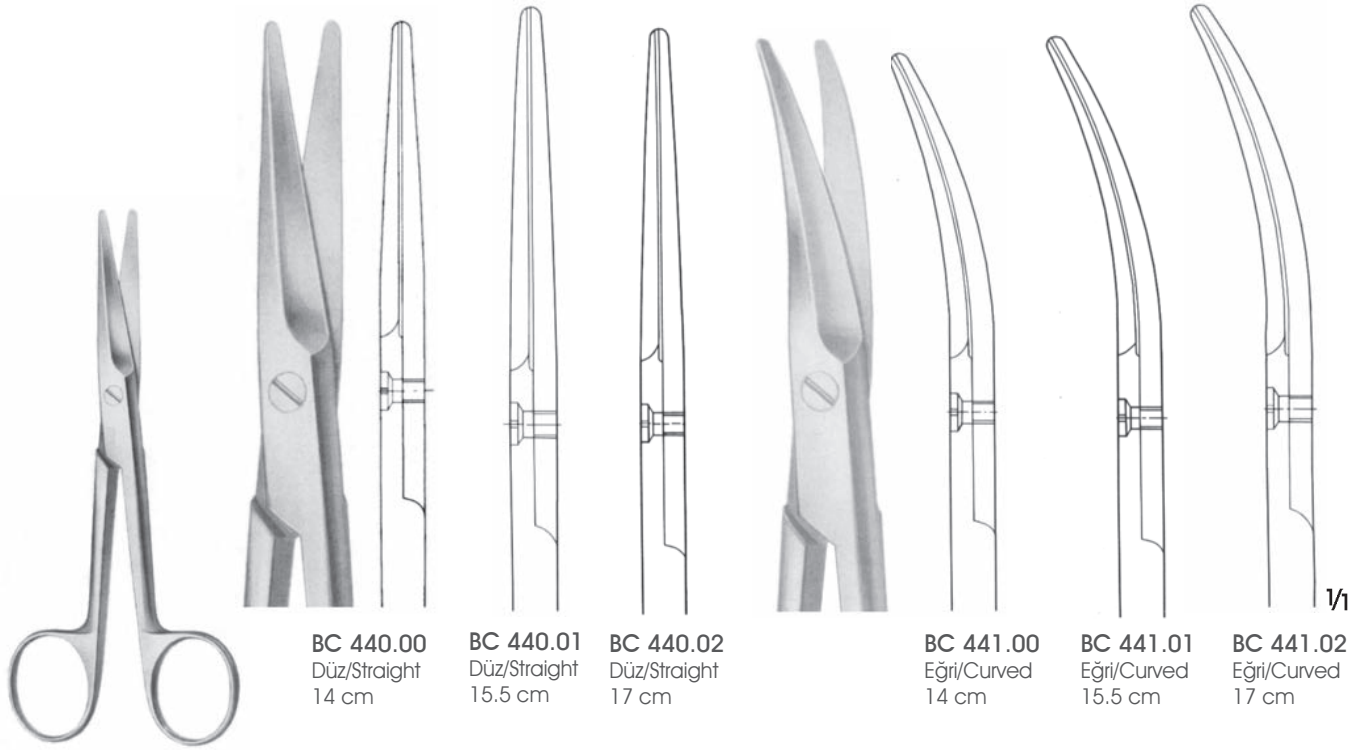

BC 440.00
Düz/Straight
14 cm

BC 440.01
Düz/Straight
15.5 cm

BC 440.02
Düz/Straight
17 cm

BC 441.00
Eğri/Curved
14 cm

BC 441.01
Eğri/Curved
15.5 cm

BC 441.02
Eğri/Curved
17 cm

MAYO
BC 440.00-BC 441.02

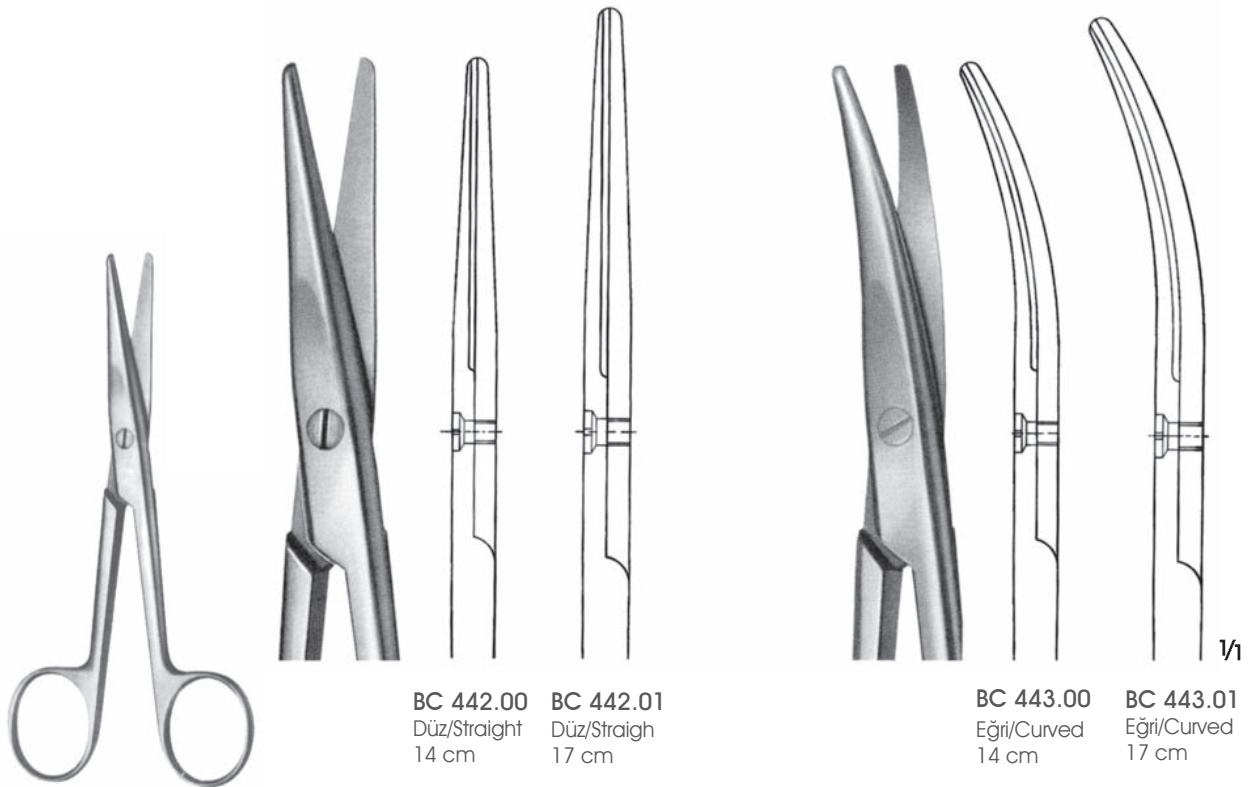

BC 442.00
Düz/Straight
14 cm

BC 442.01
Düz/Straigh
17 cm

BC 443.00
Eğri/Curved
14 cm

BC 443.01
Eğri/Curved
17 cm

MAYO-STILLE
BC 442.00-BC 443.01

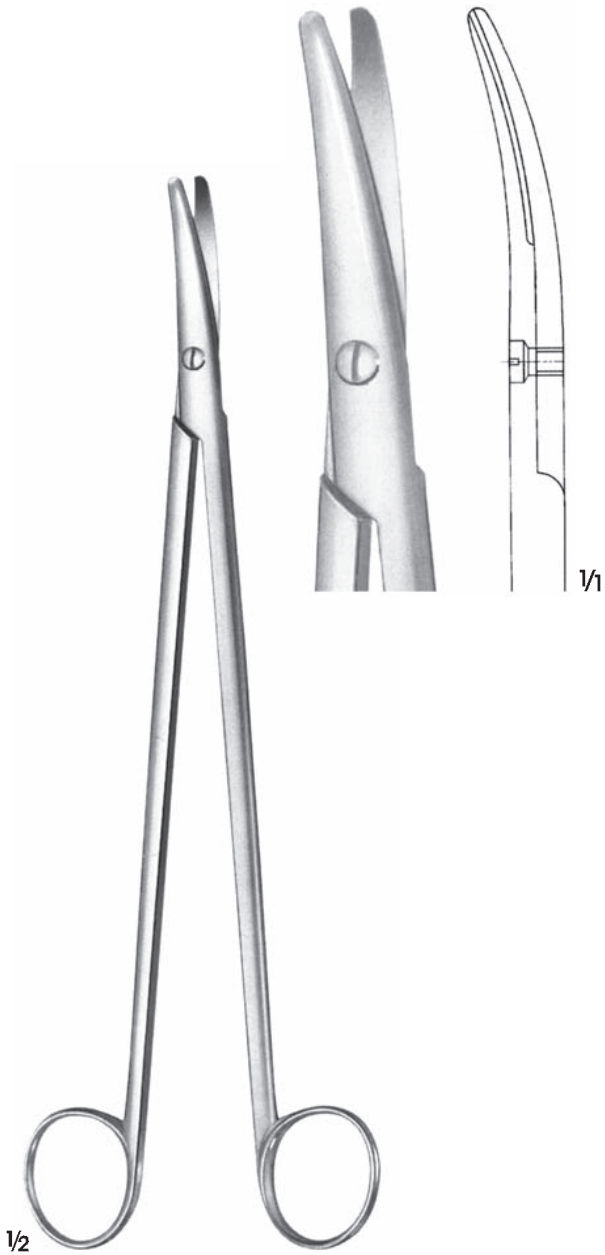

WELLER
BC 425.00
Diseksiyon makası, zorlu bölgelerde
Dissecting scissors, heavy pattern
28 cm

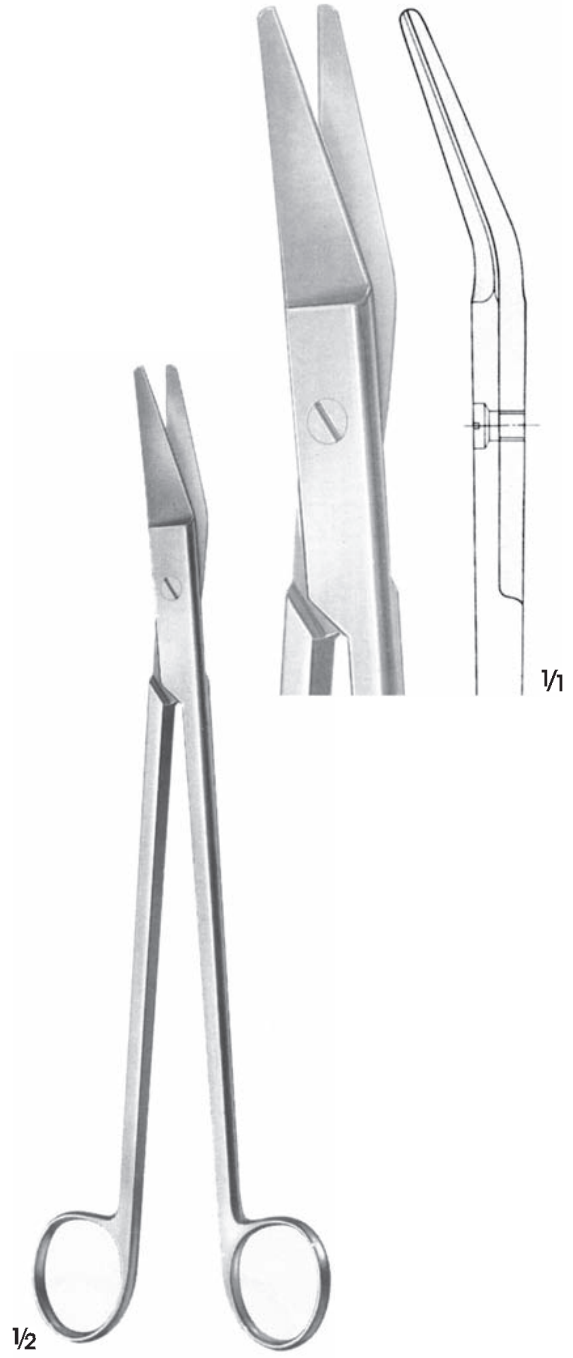

RESANO
BC 620.00
Kıkırdak makası/Cartilage scissors
25 cm





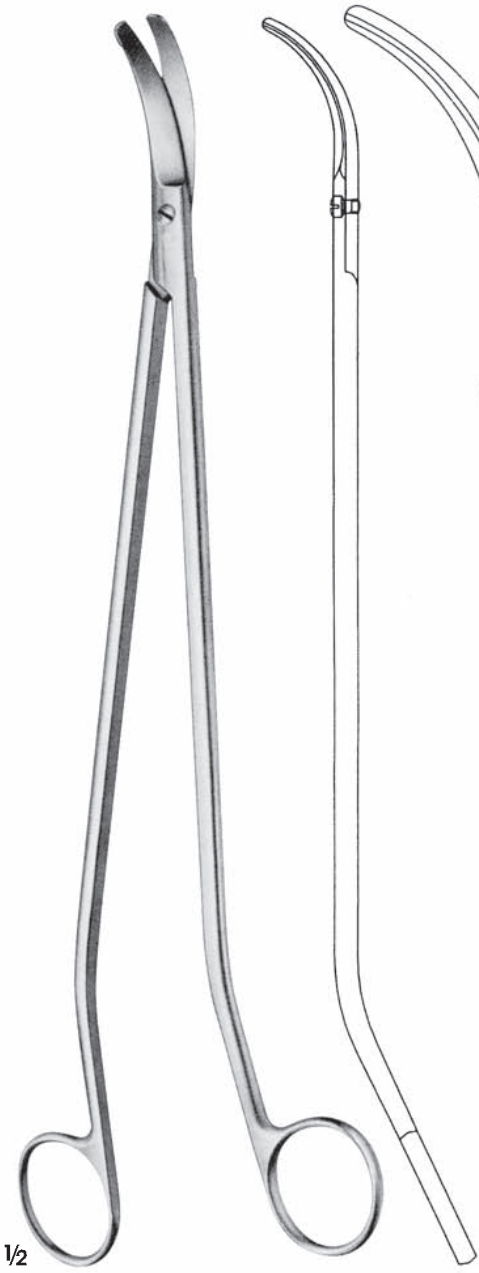

MÜLLER
BC 578.00
Rektal makas/Rectal scissors
S-şeklinde/S-shaped
32.5 cm

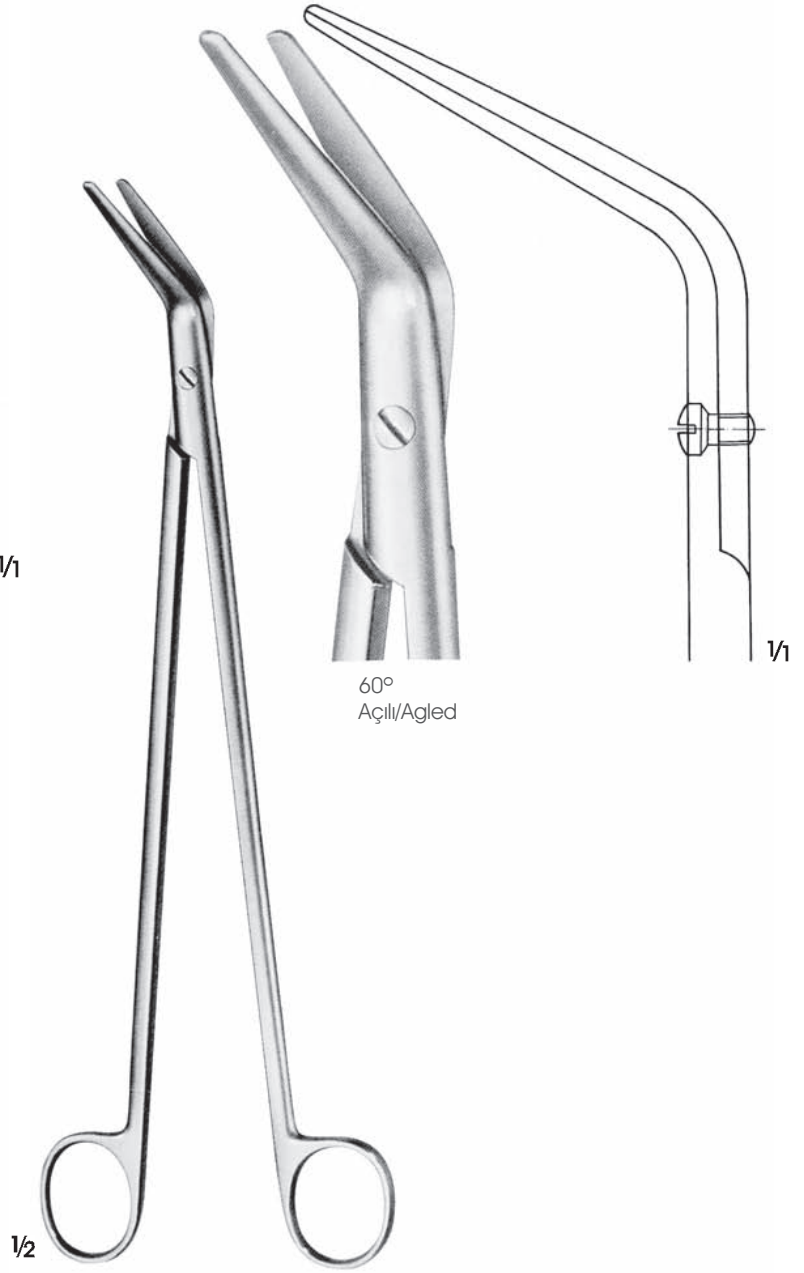

BC 575.00
Dikiş atıldıktan sonra bağırsak
kesmek için disseksiyon makası
Dissecting scissors for cutting
of the bowel after suturing with
suture device
28 cm

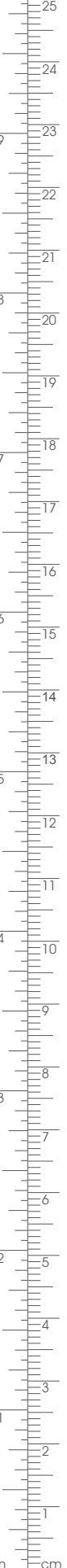



KIEBACK
BC 614.00-BC 614.02
Parametrium makası
Parametrium scissors

BC 614.00 BC 614.02
24 cm 35 cm

KEIBACK
BC 615.00-BC 615.02
Parametrium makasları, yana kavisli,
tek ağızı sonda uclu
Parametrium scissors, curved to side,
with one probe pointed blade

C 615.00 C 615.02
26 cm 35 cm



1/1



1/1

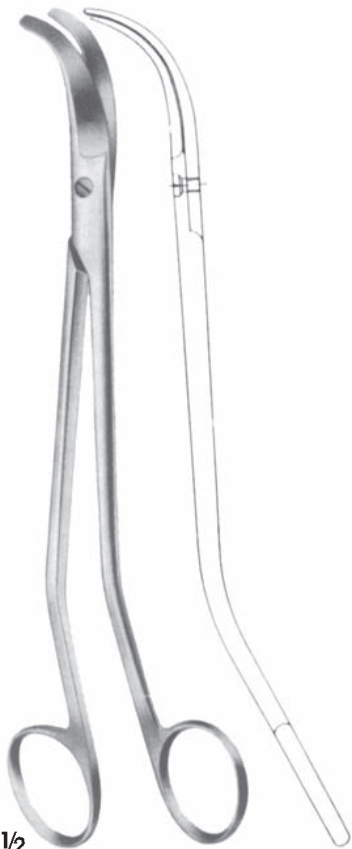

1/2

BOZEMANN
BC 490.00
Rahim makası/Uterine scissors
22 cm

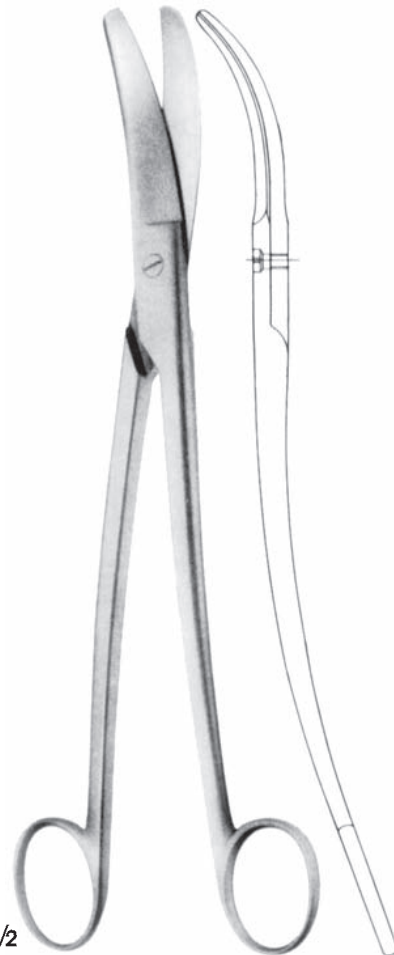

1/2

SIEBOLD
BC 491.00
Rahim makası/Uterine scissors
24.5 cm





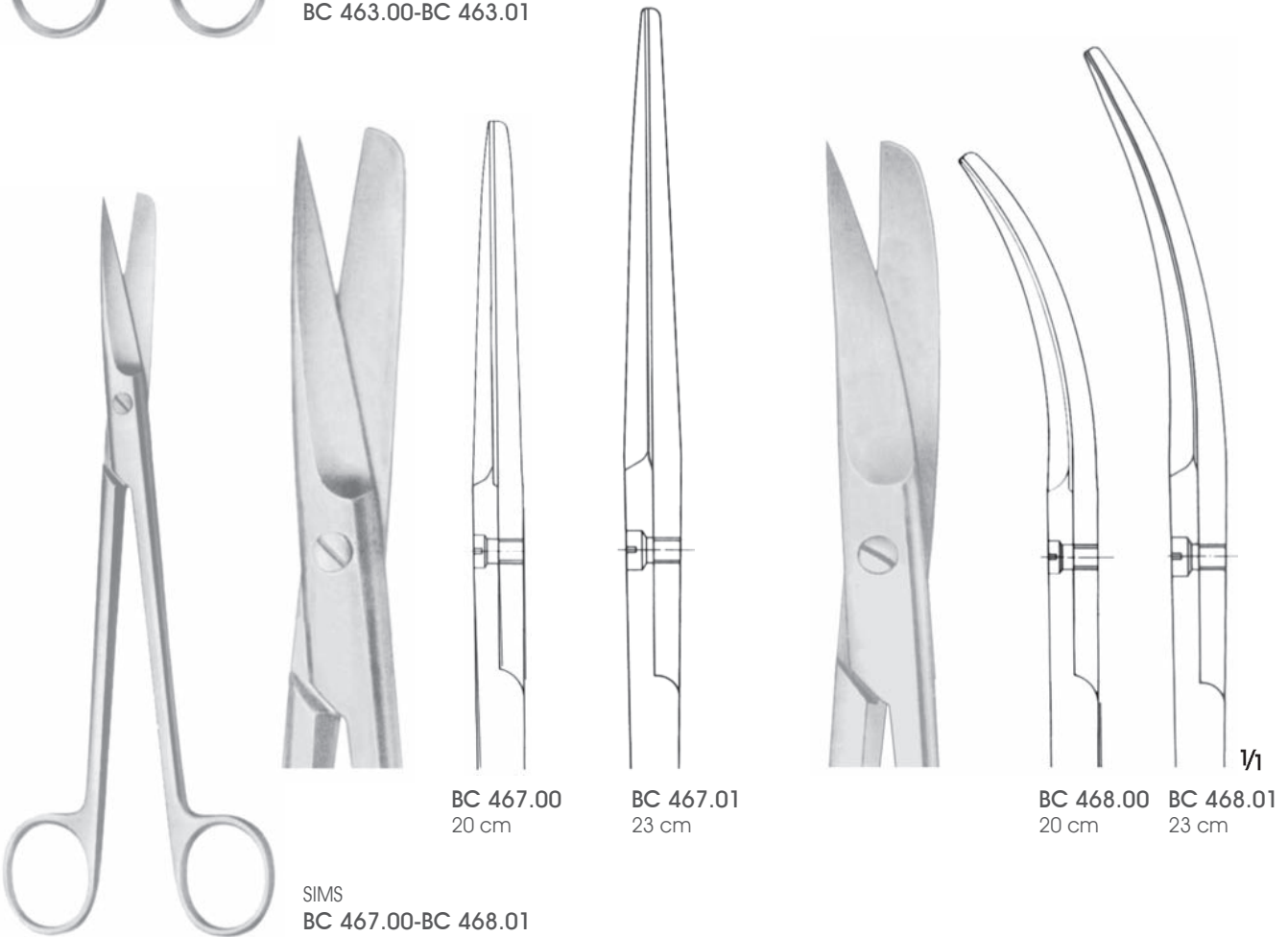
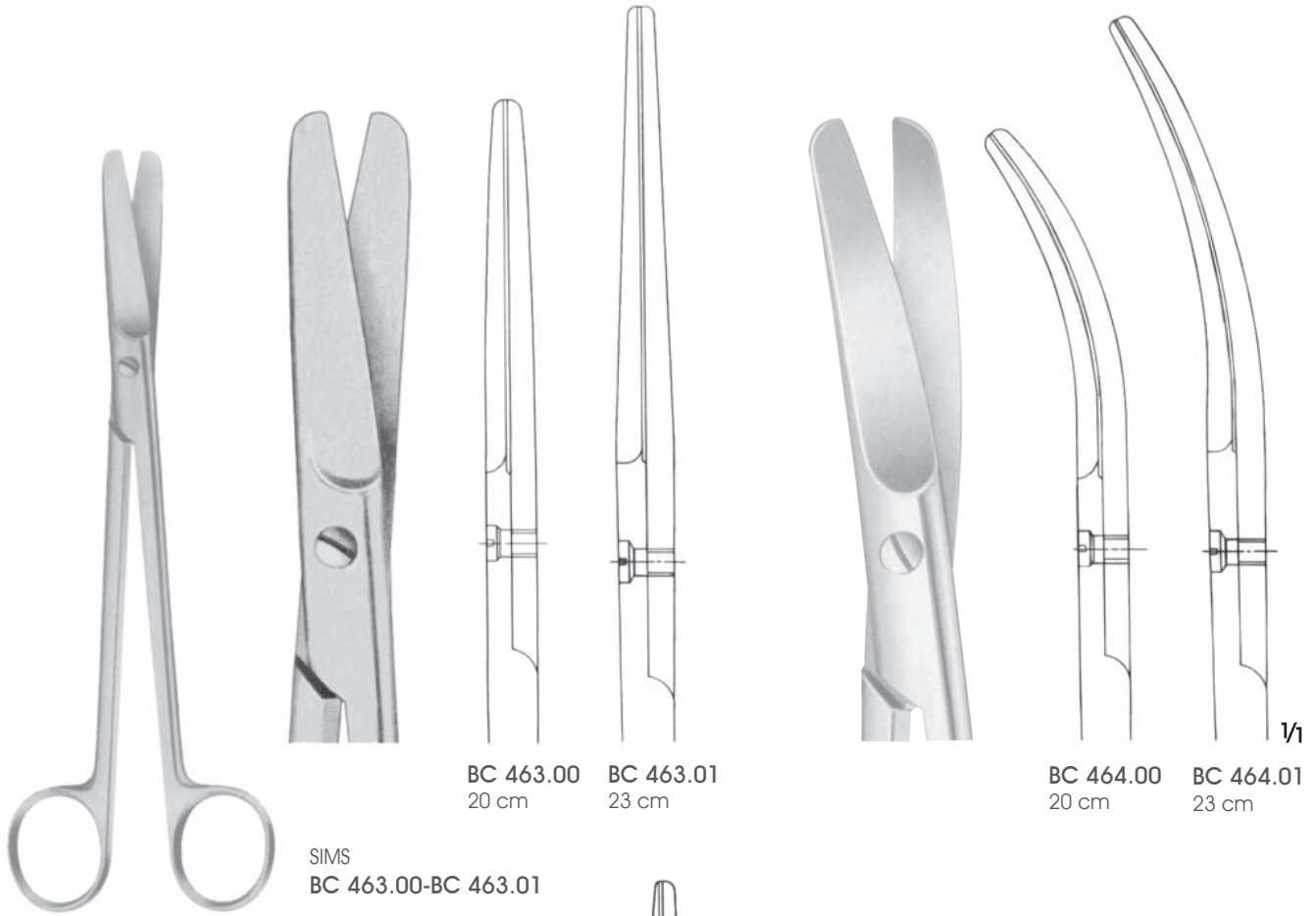

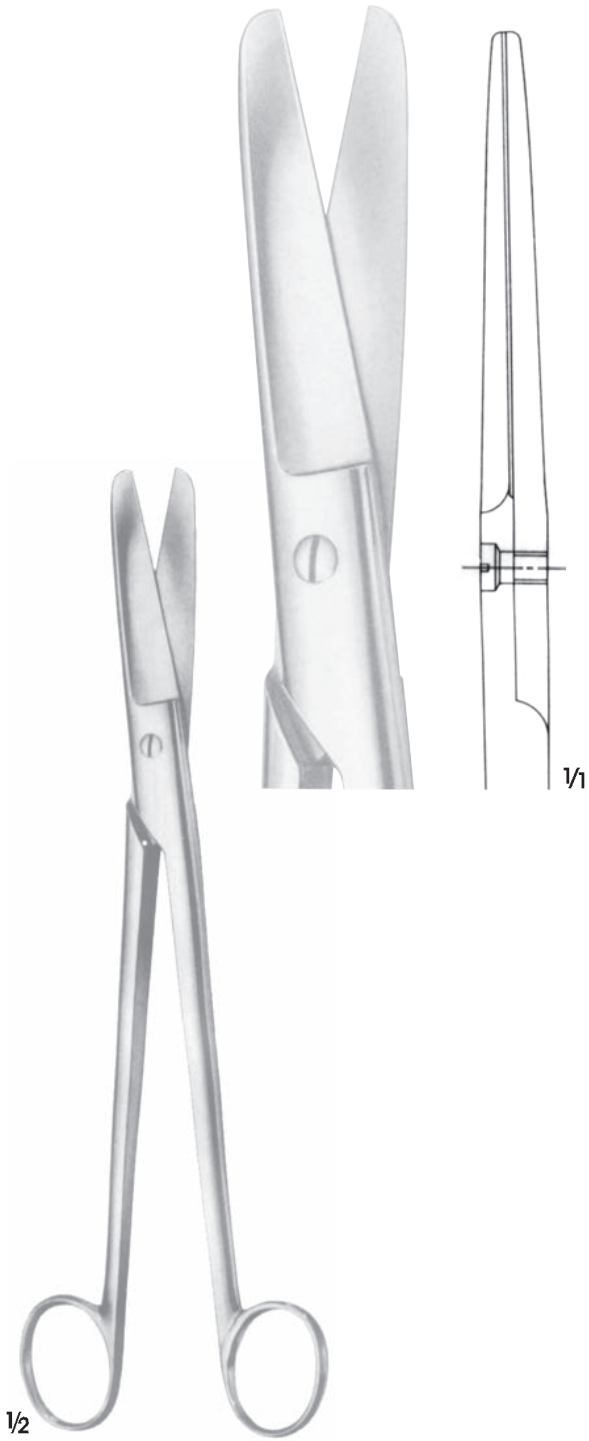

SIMS SIEBOLD
BC 492.00
Rahim makası/Uterine scissors
25 cm

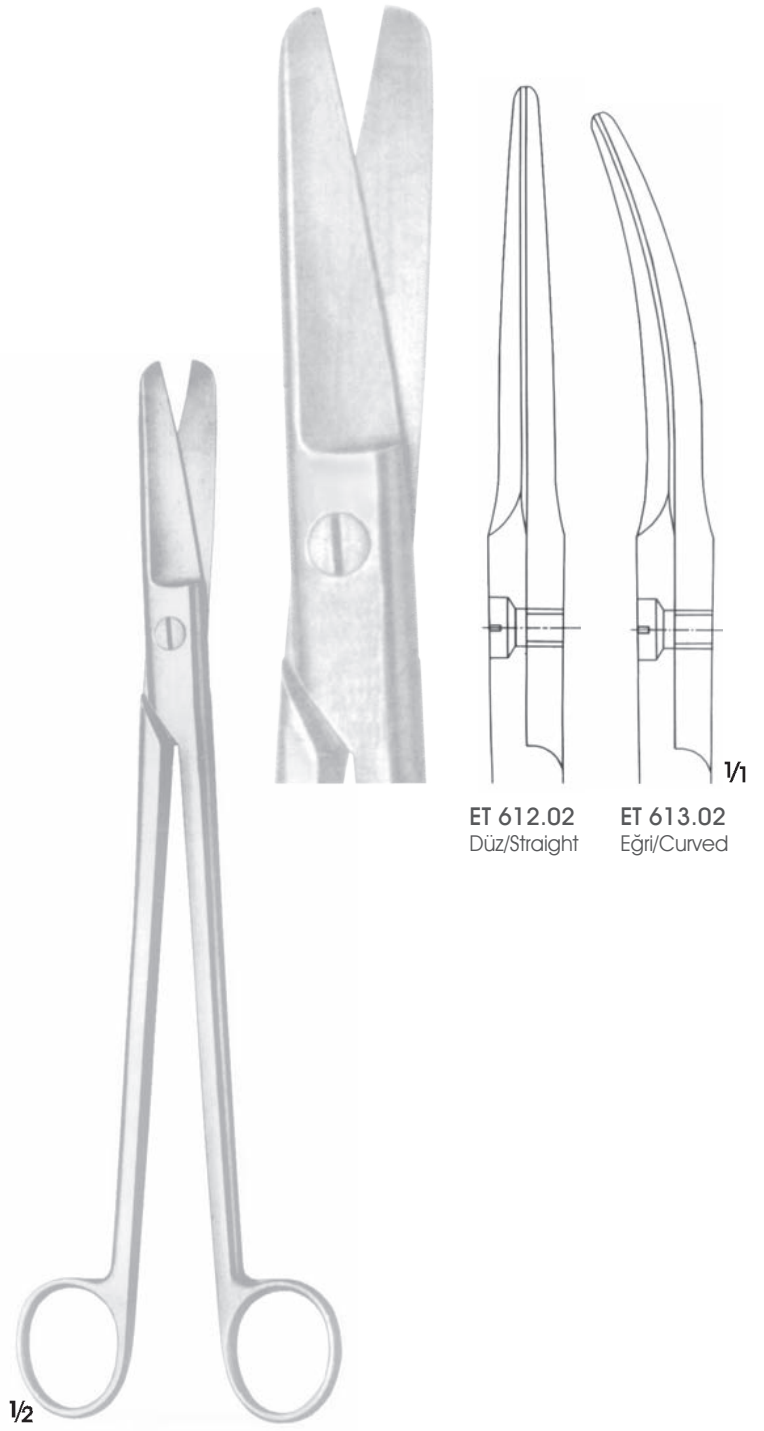

DUBOIS
BC 612.02-BC 613.02
Embriyo makası/Embriyo scissors
27.5 cm

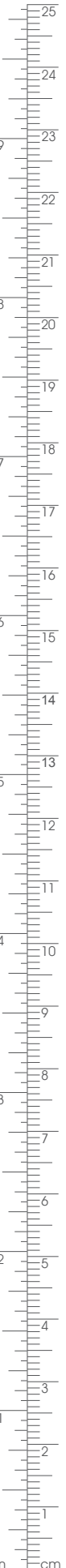
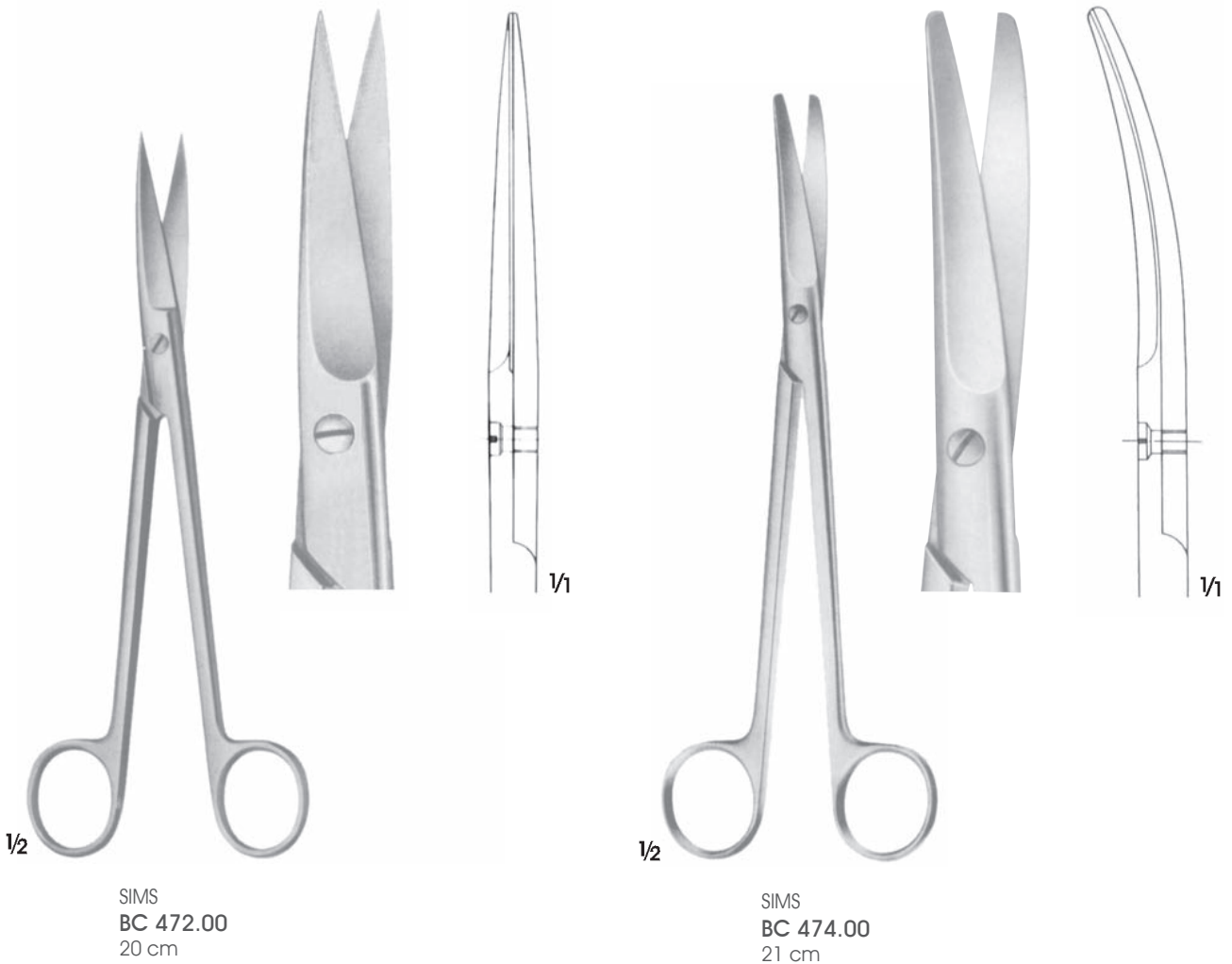
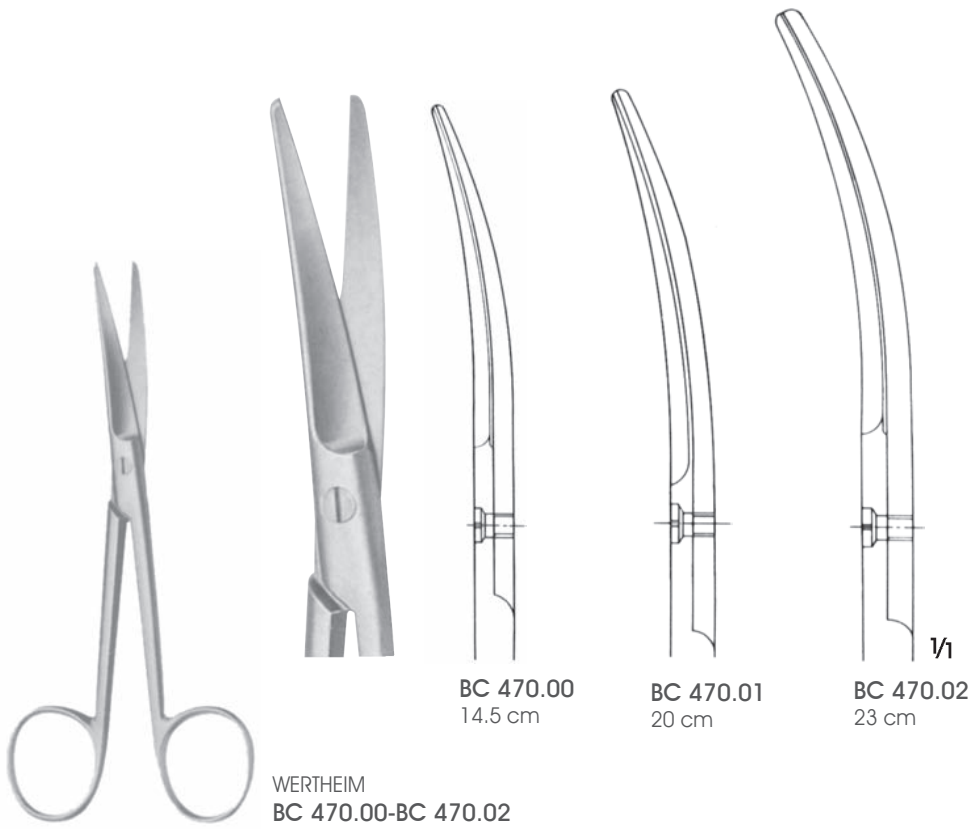

Standart bleyd
Standard blade

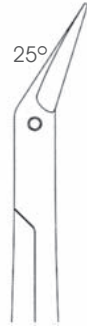

BC 513.30

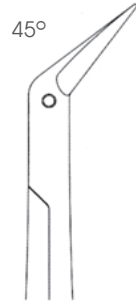

BC 513.31

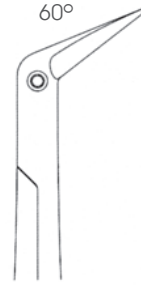

BC 513.33

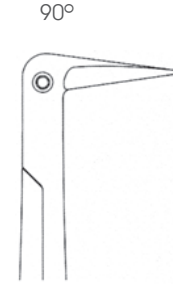

BC 513.34



BC 513.35

Hassas bleyd
Delicate blade



BC 513.10

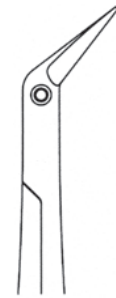

BC 513.11

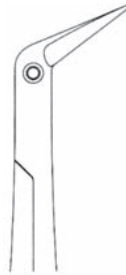

BC 513.13

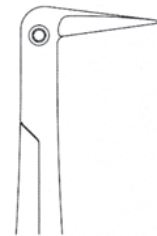

BC 513.14

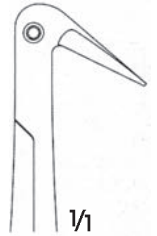

BC 513.15

Ultra hassas bleyd
Ultra delicate blade

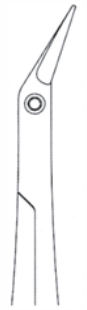

BC 513.00

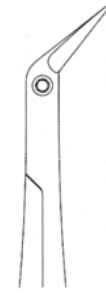

BC 513.01



BC 513.03

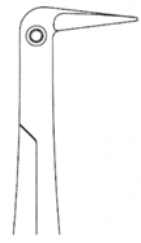

BC 513.04

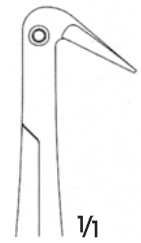

BC 513.05

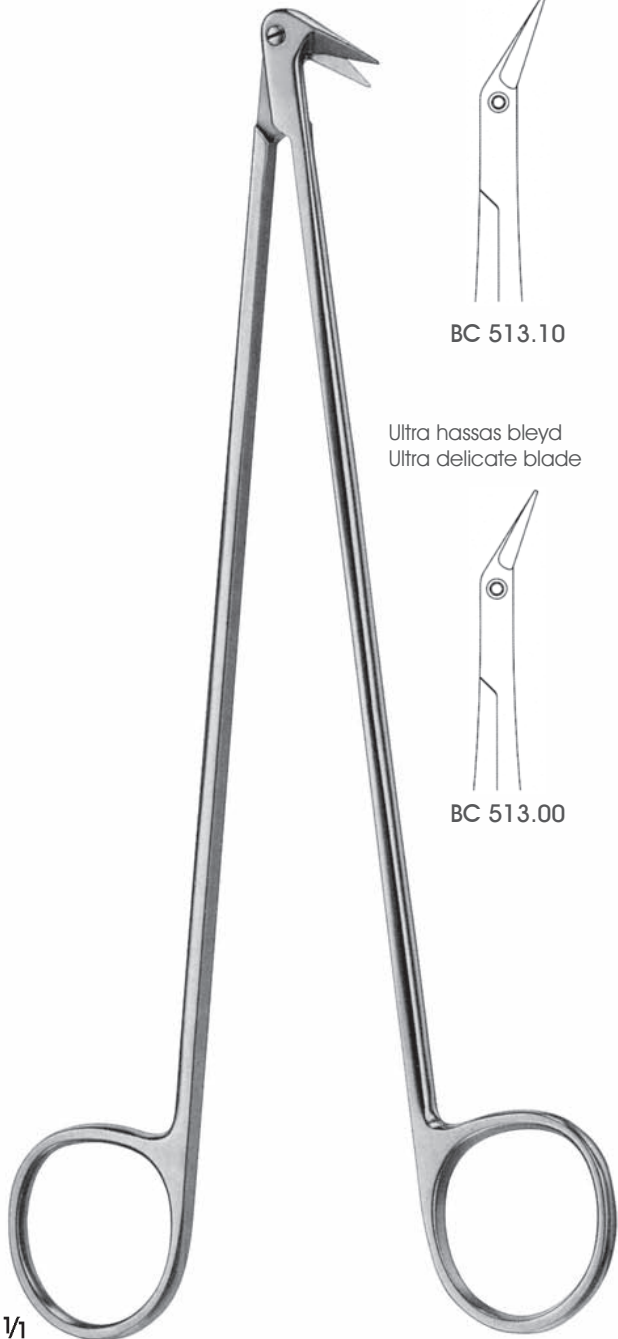

BC 513.00-BC 513.35
18 cm

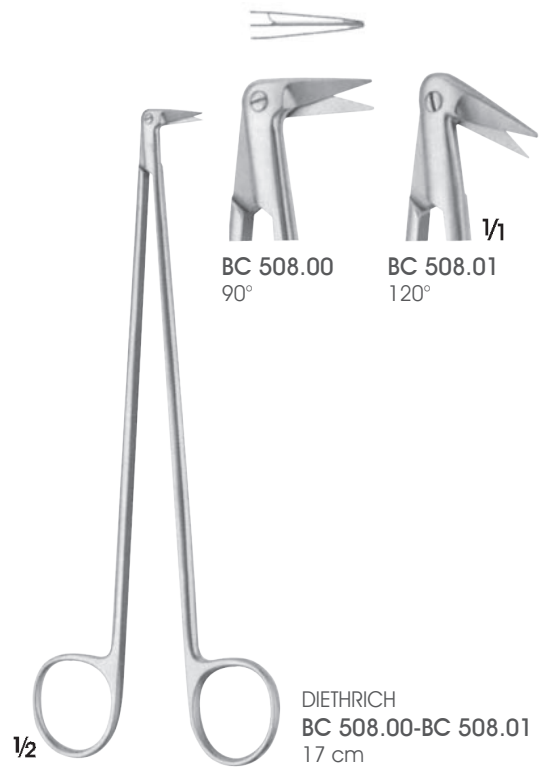
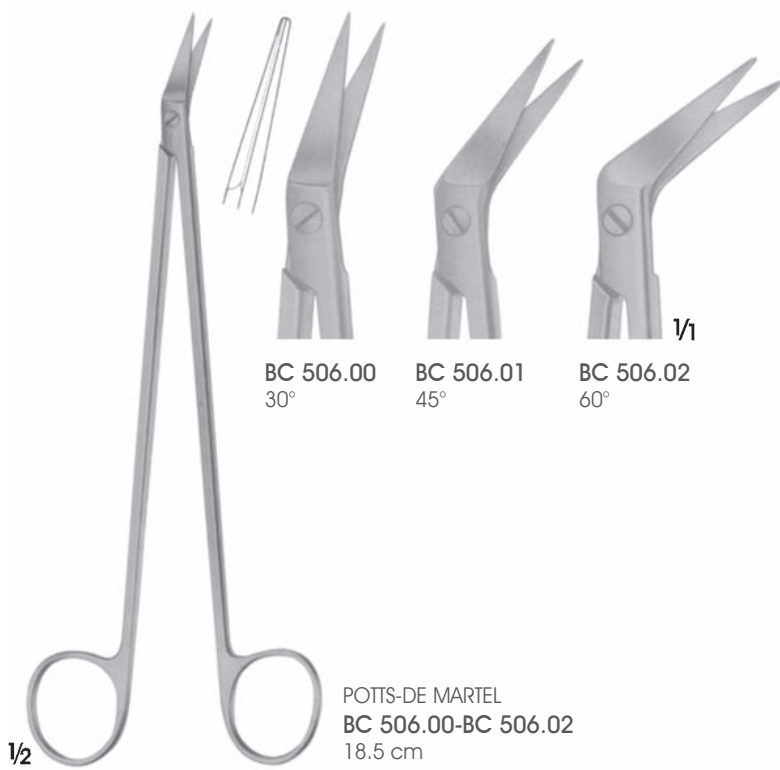
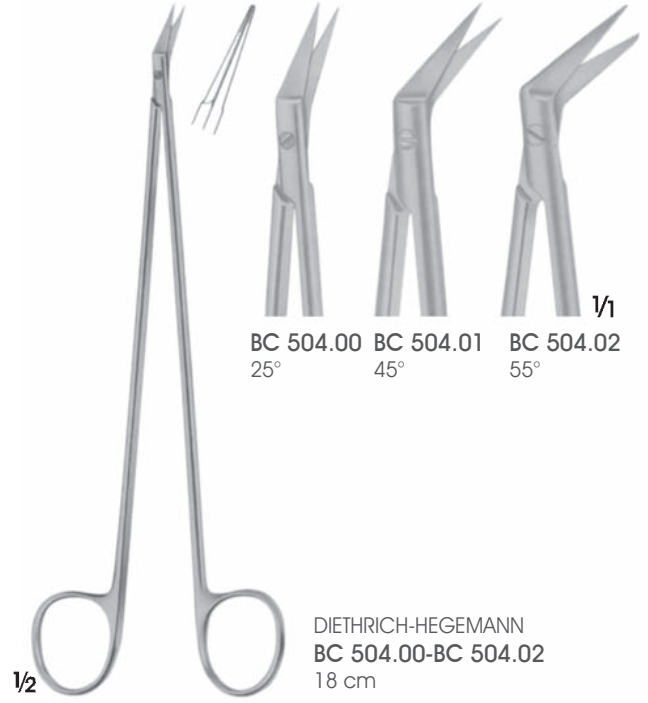
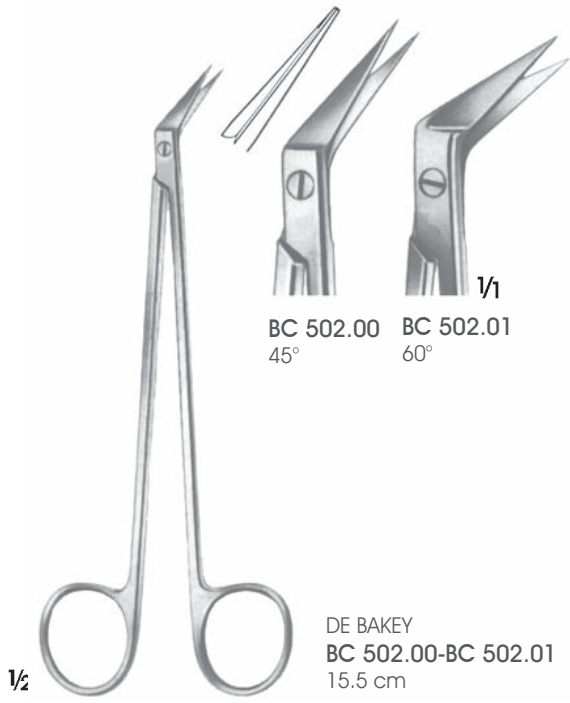

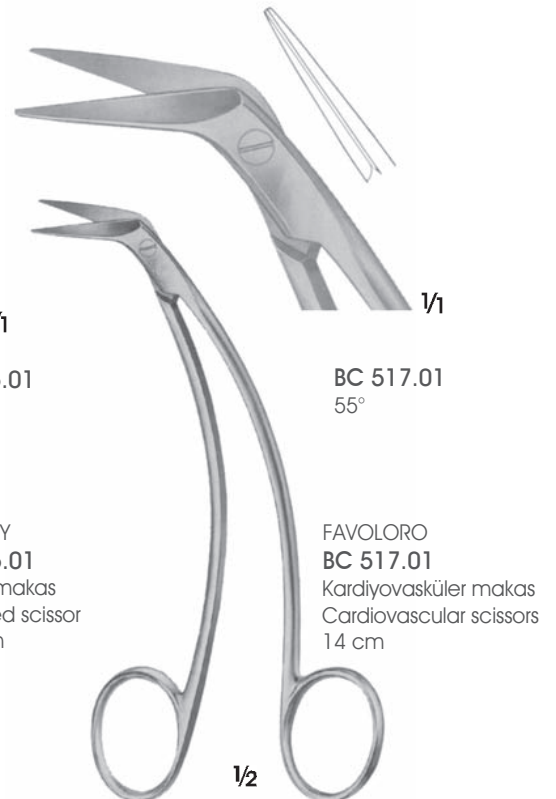
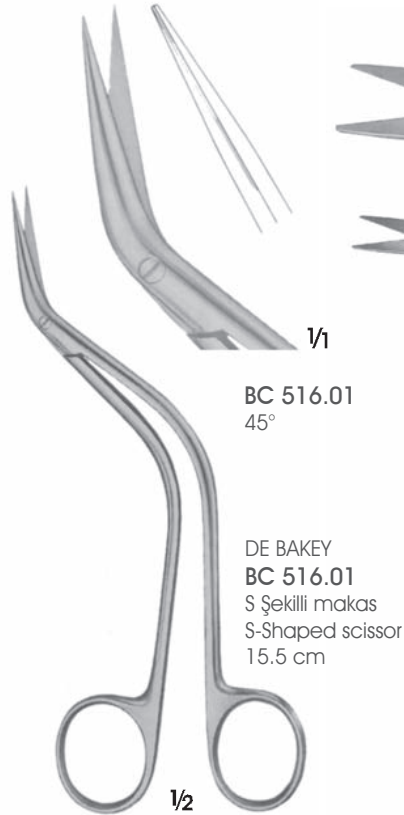
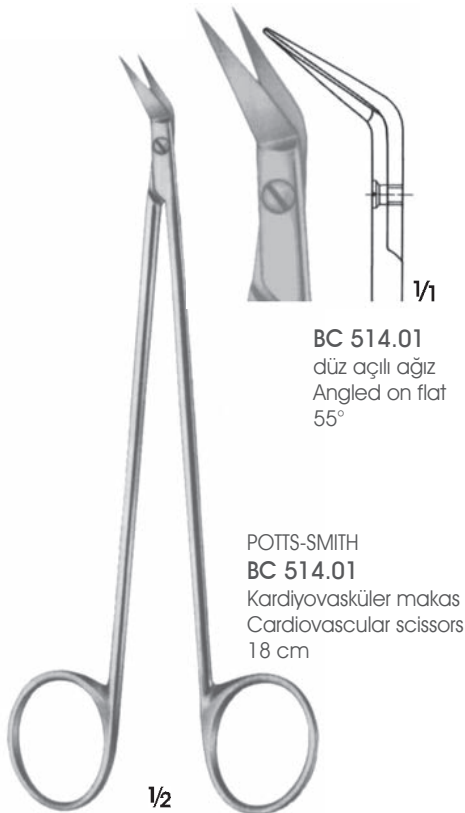
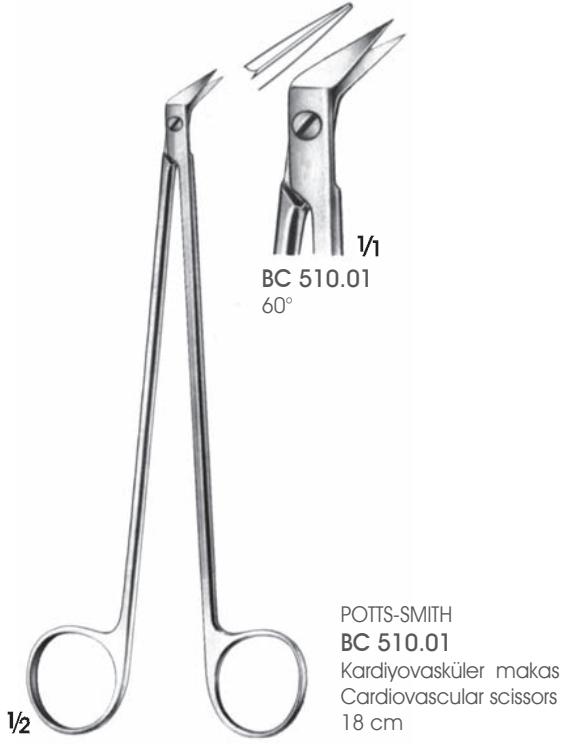

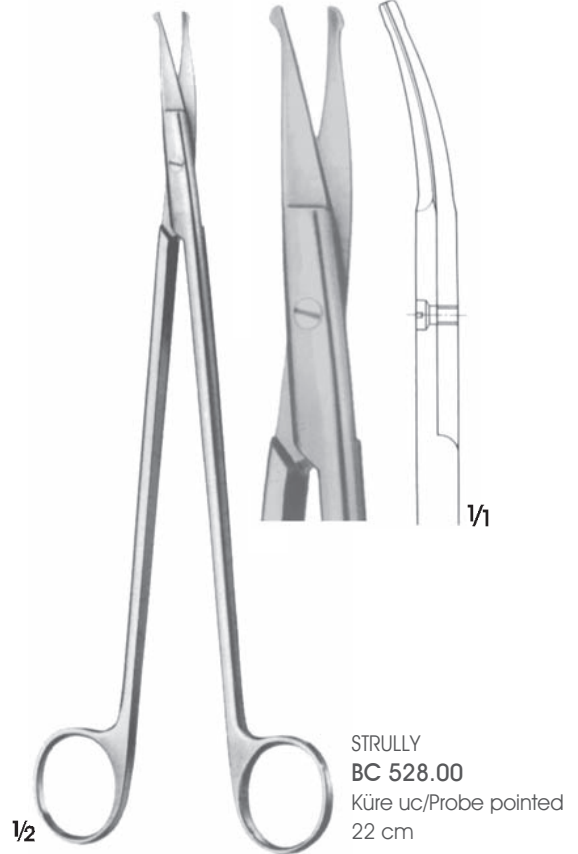
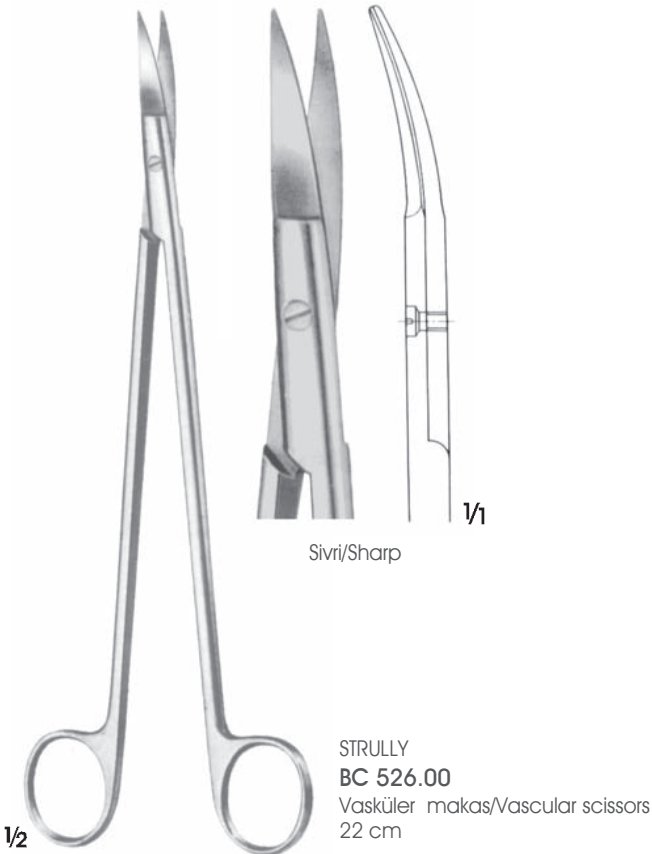
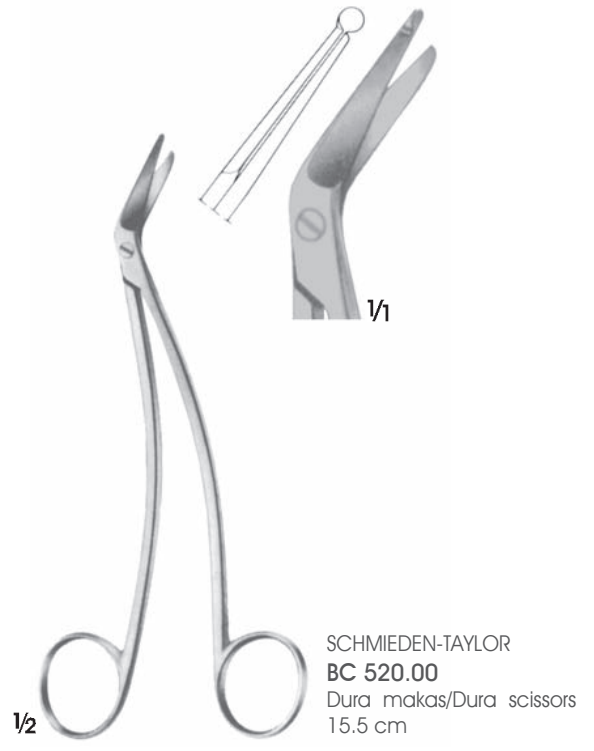
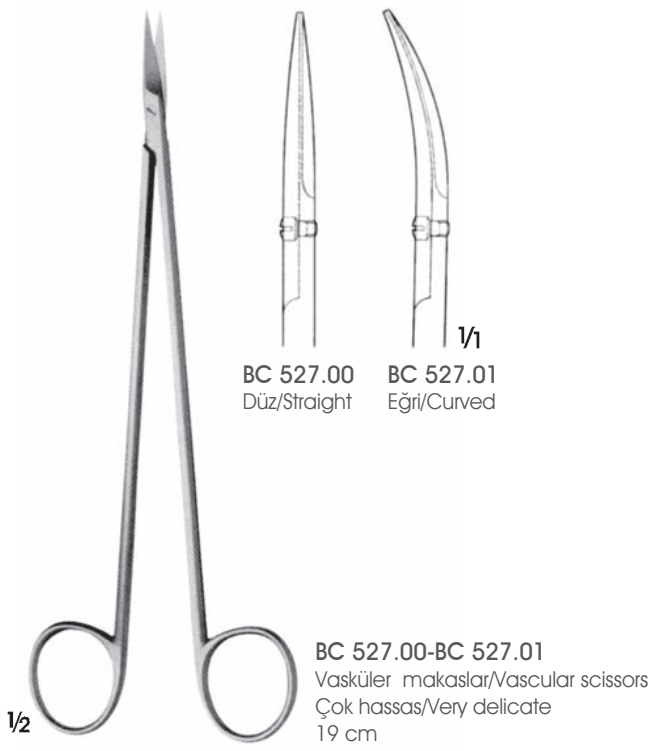

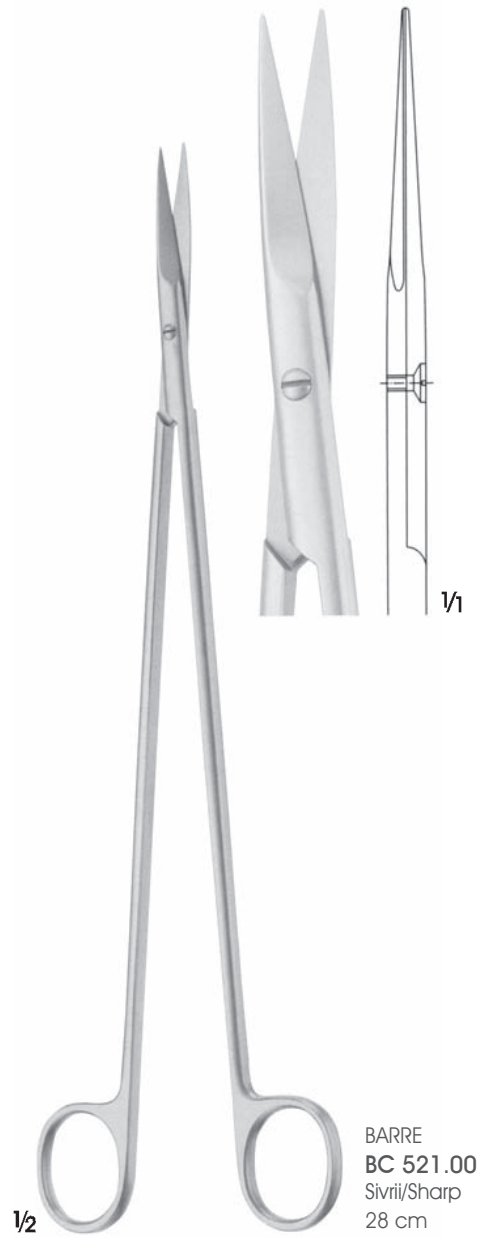
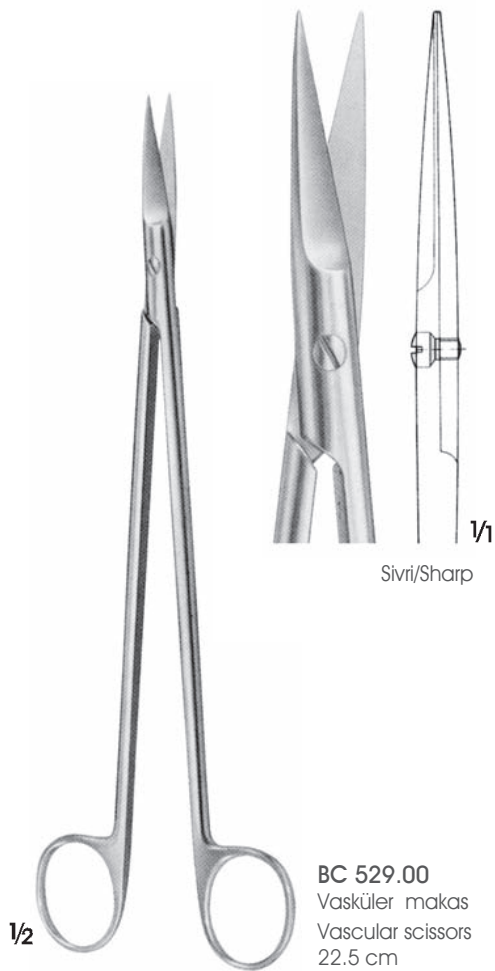
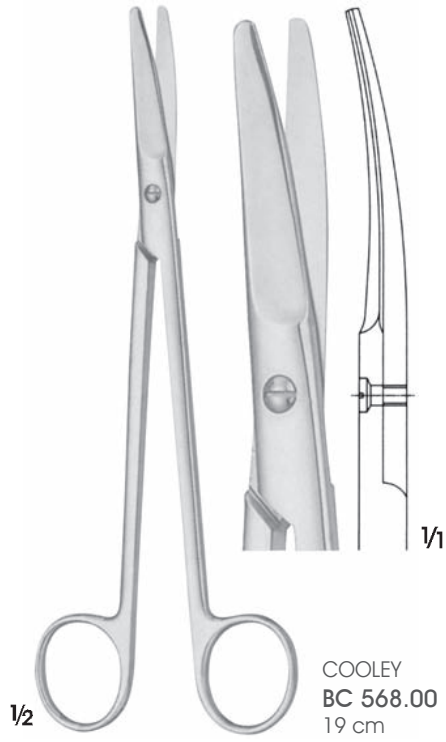

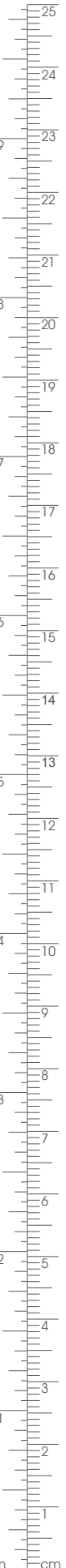
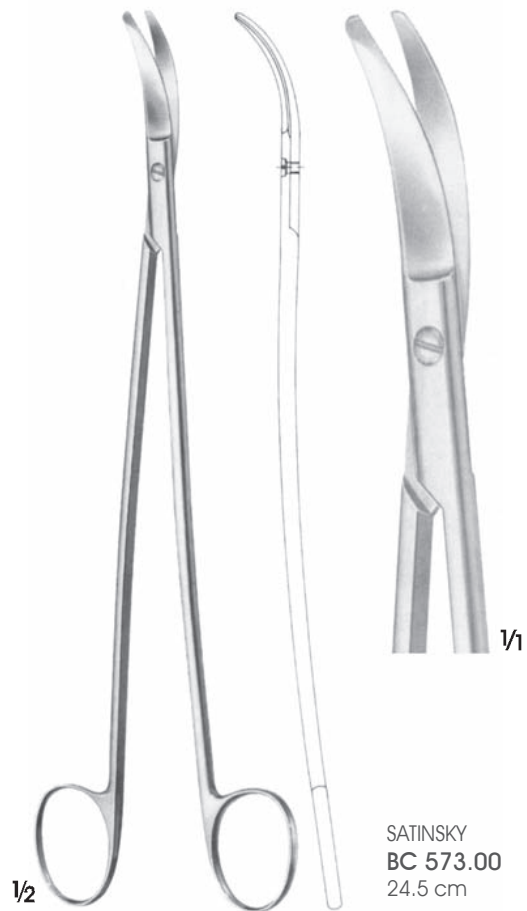
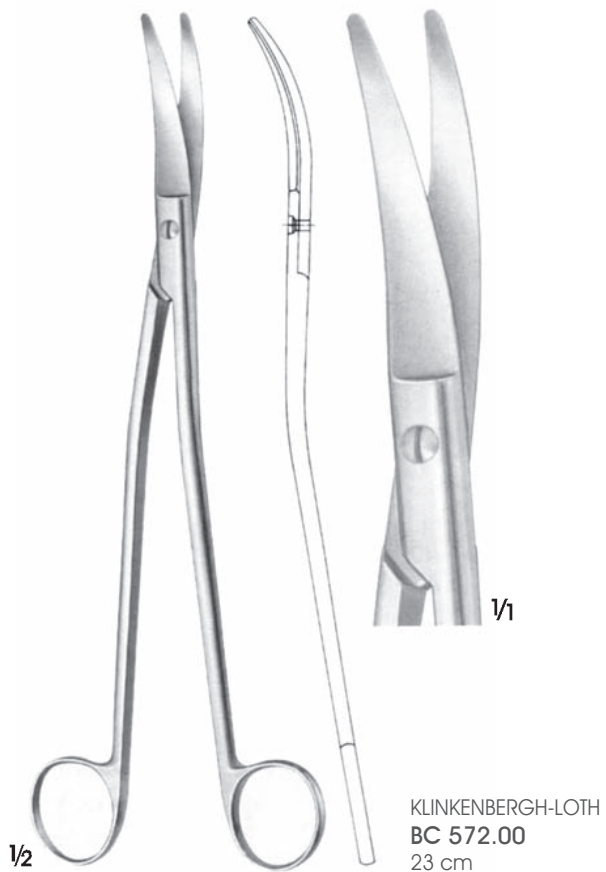
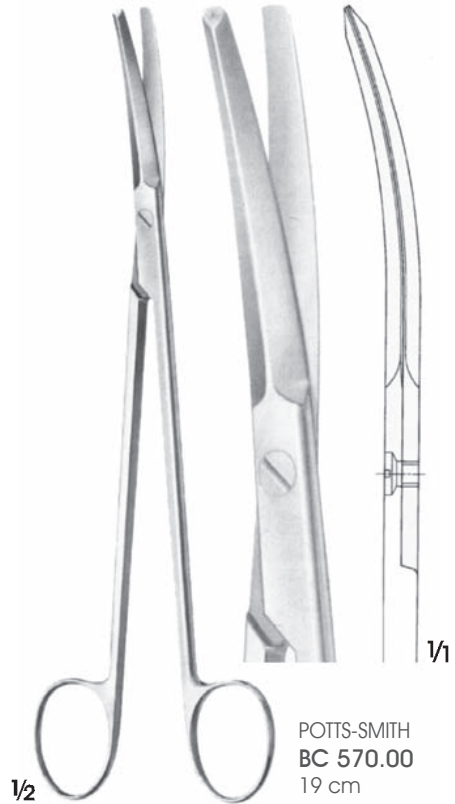
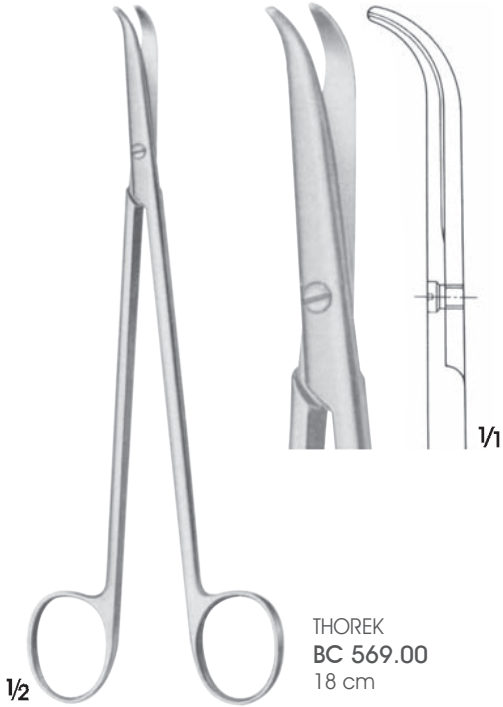



ET 600.00
Göbek kordonu makası
Umbilical cord scissors
10.5 cm



SCHUMACHER
ET 602.00
Göbek kordonu makası
Umbilical cord scissors
15.5 cm

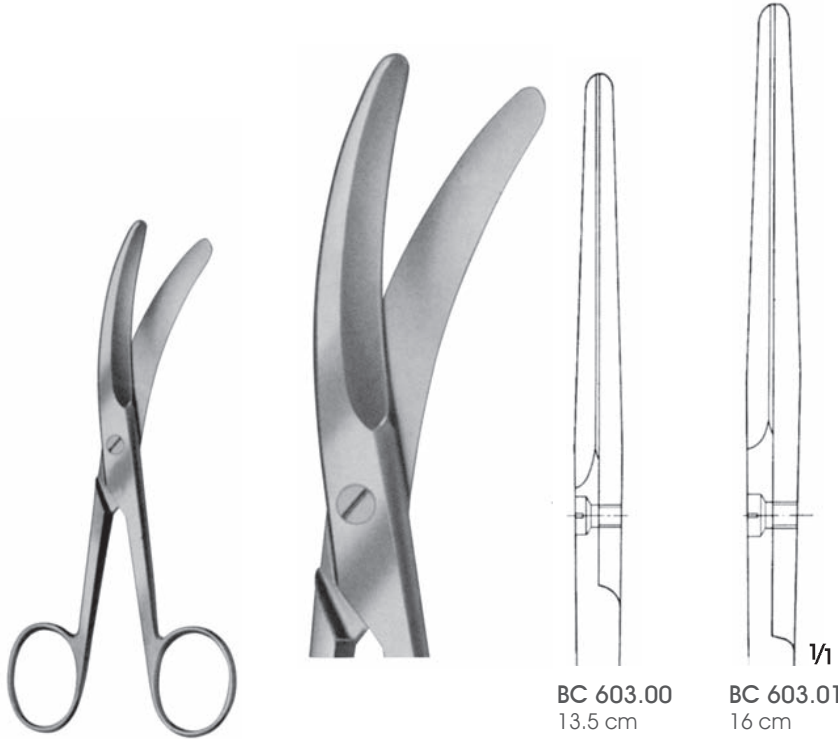

BC 603.00-BC 603.01
Göbek kordonu makasları
Umbilical Cord scissors

BC 603.00
13.5 cm

BC 603.01
16 cm



BRAUN-STADLER
BC 604.00-BC 604.01
Epizyotomi makasları/Episiotomy scissors



1/1 ET 604.00
14.5 cm



1/1 ET 604.01
20 cm



1/2 ET 610.00
Epizyotomi makası/Episiotomy scissors
24 cm

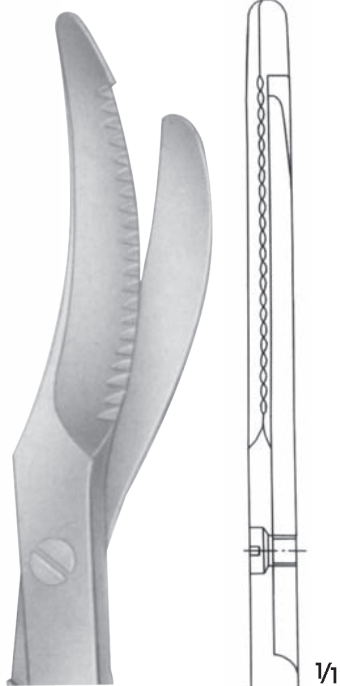

1/1

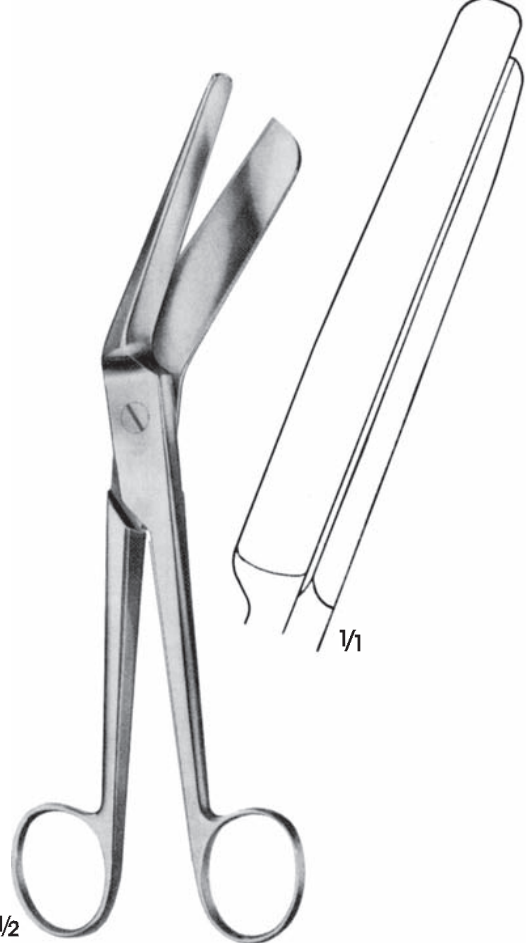

1/2 BRAUN-STADLER
BC 632.00
Bandaj makası/Bandage scissor
22.5 cm

1/1

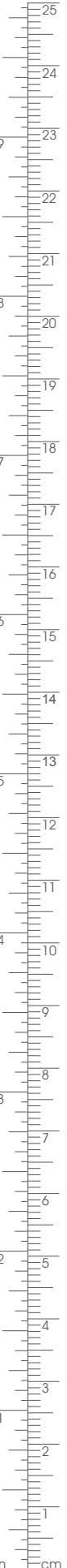

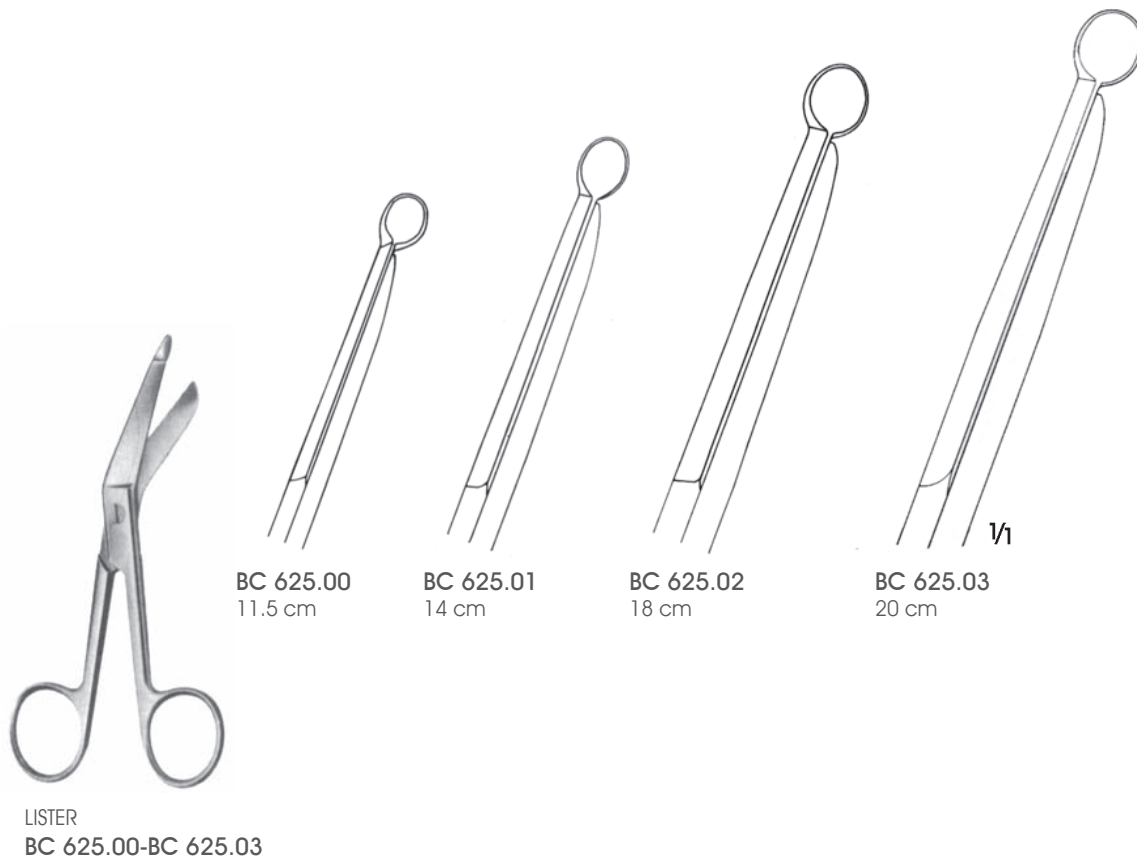
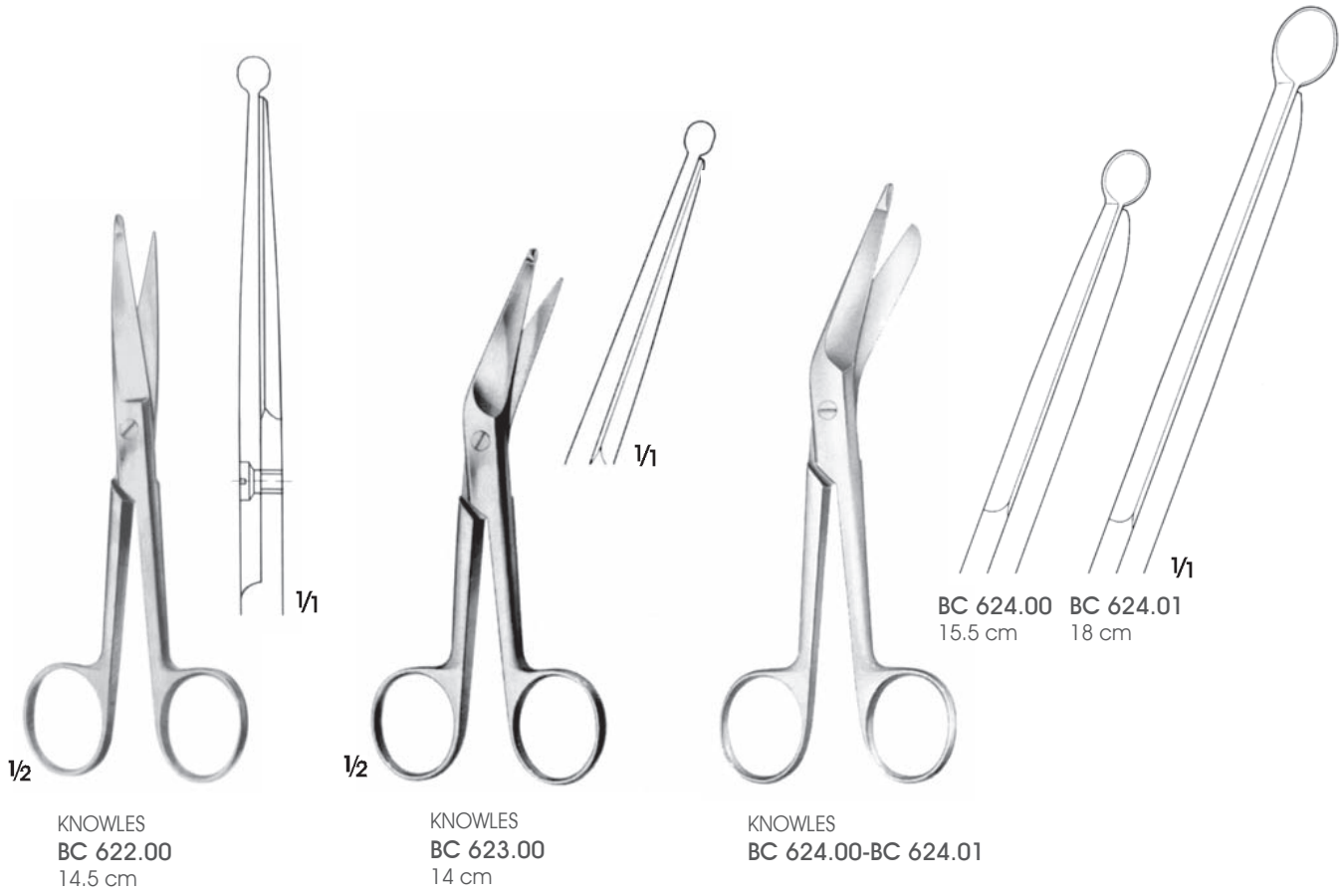



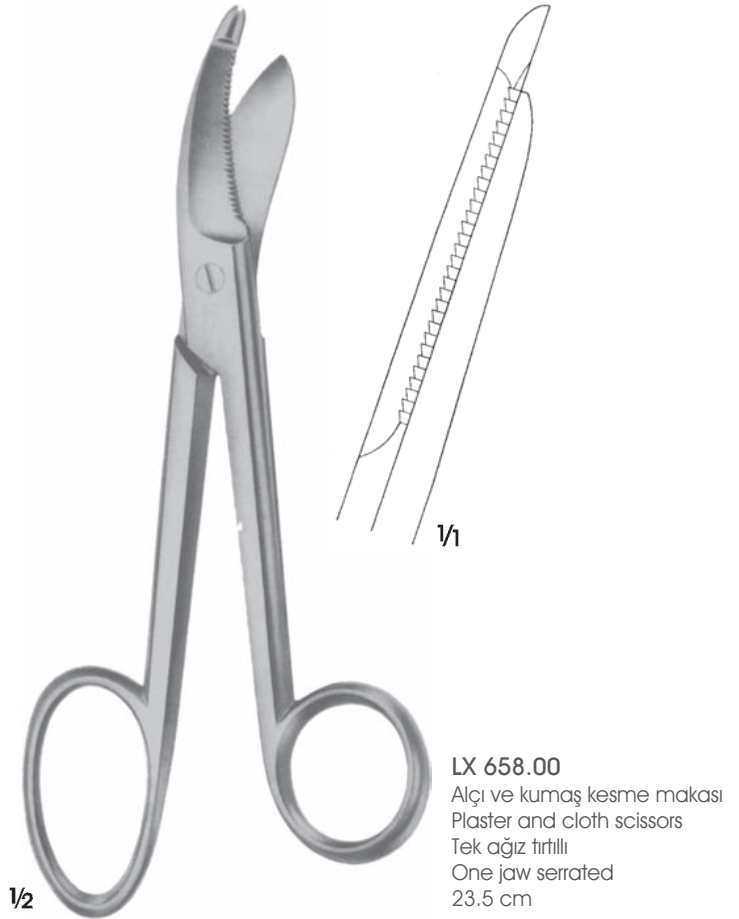
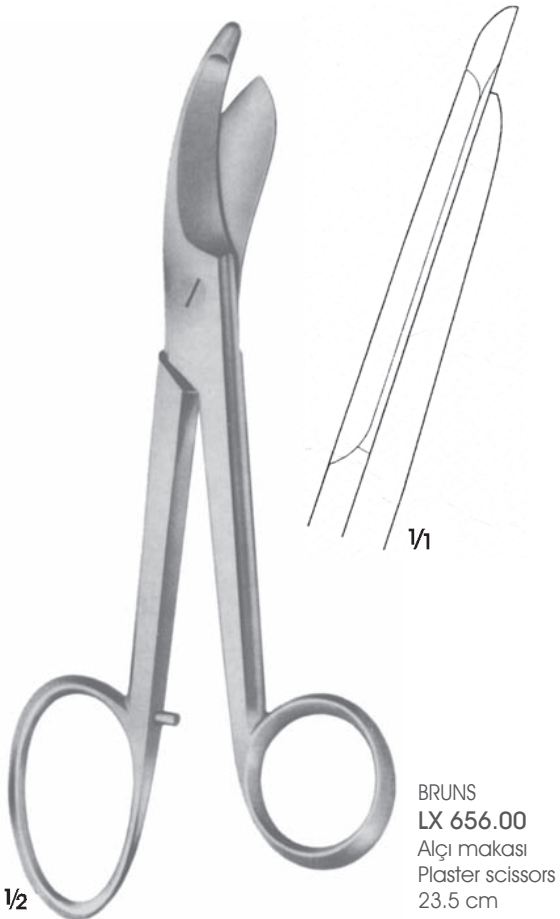
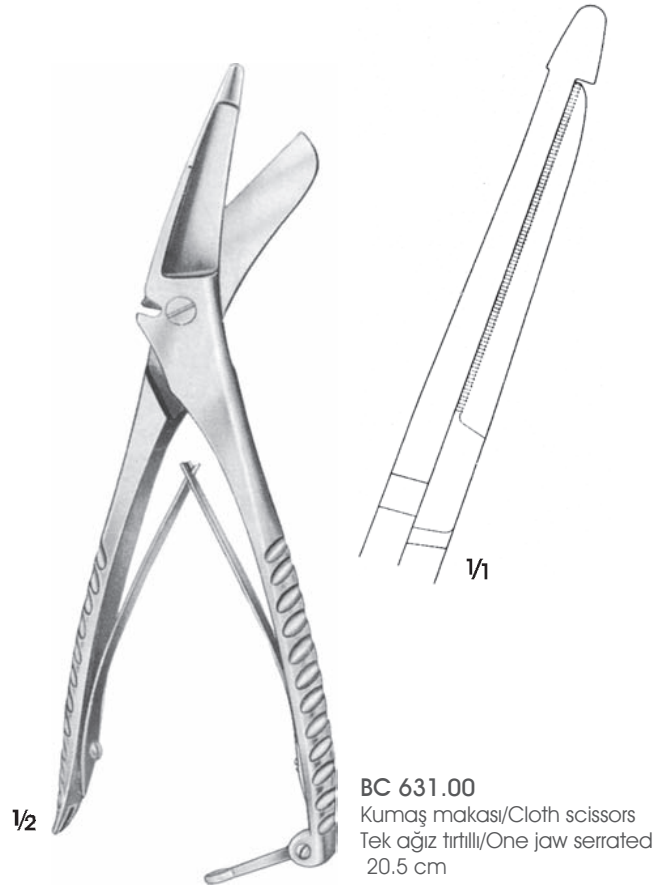
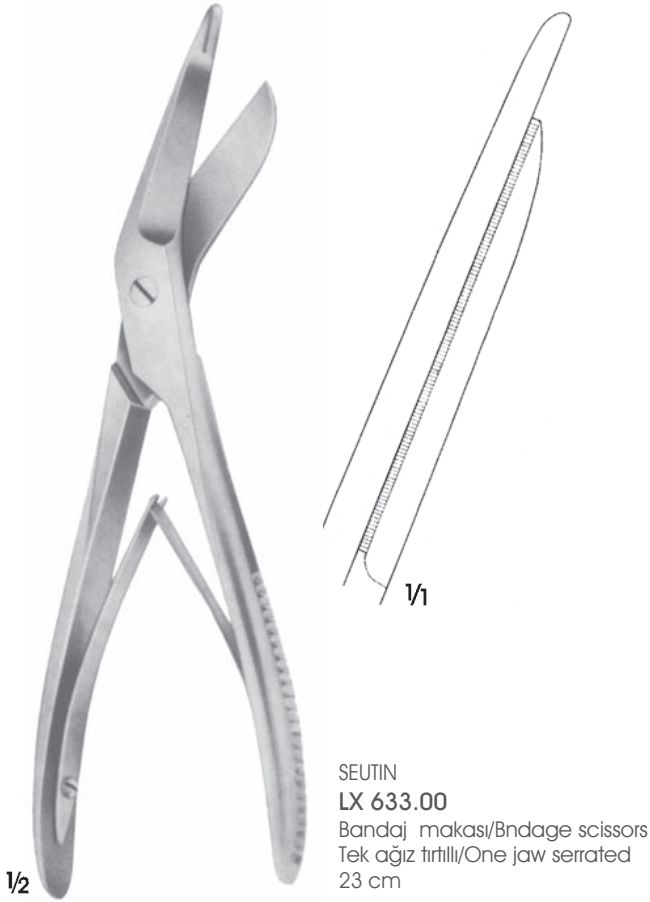

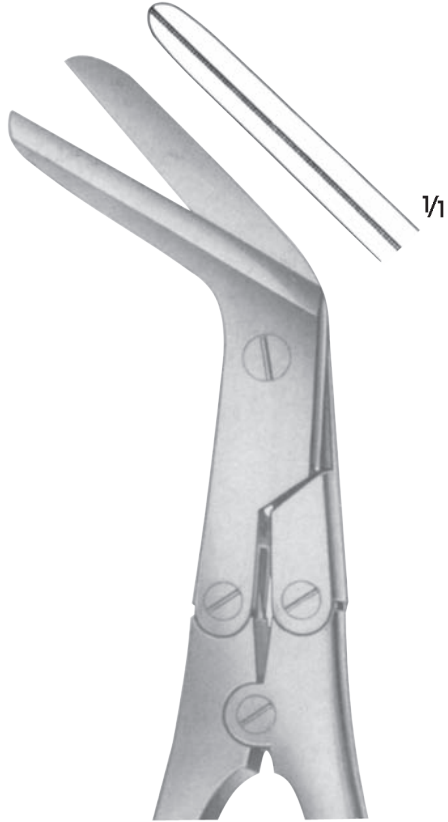

KILLIAN
OP 695.00
Çift ağız tırtıllı
Both jaws serrated
20 cm



MUHLING
FO 695.01
21 cm



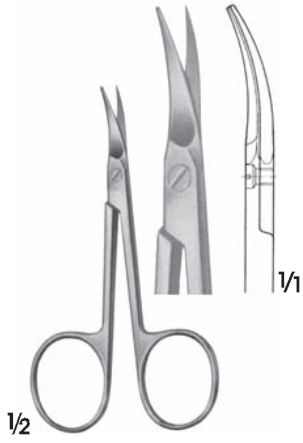

BC 217.01
Tırnak makası
Nail scissors
9 cm



BC 217.00
Hassas bölge için tırnak makası
Nail Scissors, especially delicate
pattern
9 cm

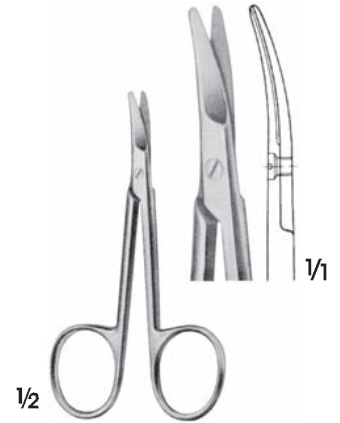

BC 218.00
Çocuk tırnak makası
Baby nail scissors
8.5 cm

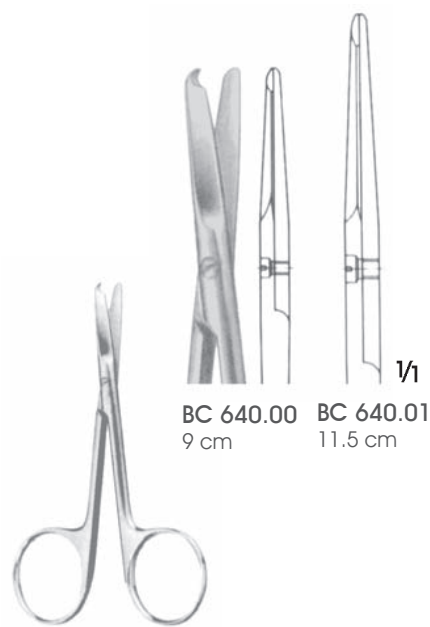

SPENCER
BC 640.00-BC 640.01
Ligatür makası Ligature
scissors

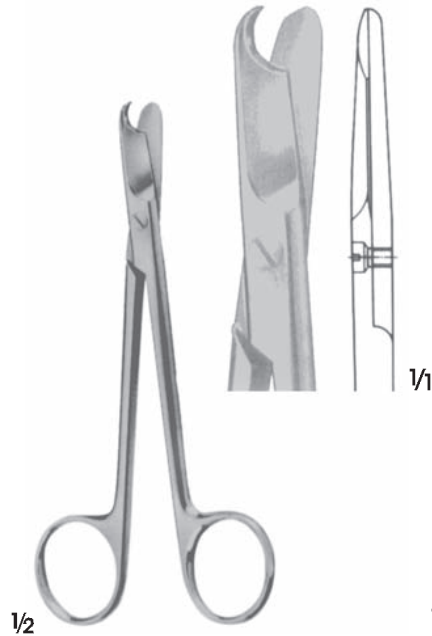

LITTAUER
BC 642.00
Ligatür makası
Ligature scissors
13.5 cm

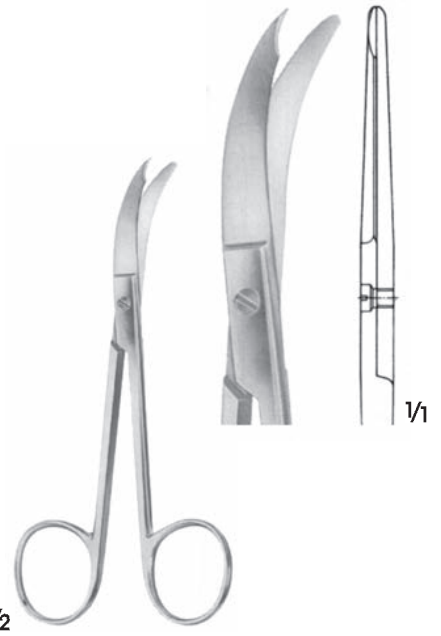

NORTHBENT
BC 643.00
Ligatür makası
Ligature scissors
12 cm



BEEBE
DP 661.00 - DP 665.00
11 cm



DP 661.00 DP 662.00

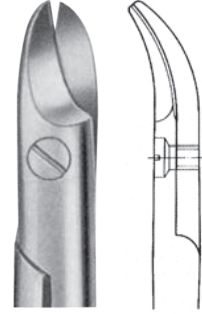

DP 663.00
Geniş ağız bleyd
Broad blades

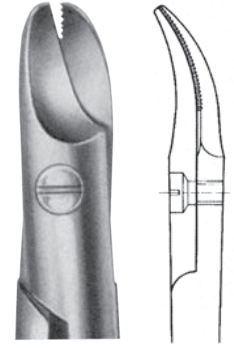

DP 664.00
Tek ağız tırtilli
One jaw serrated

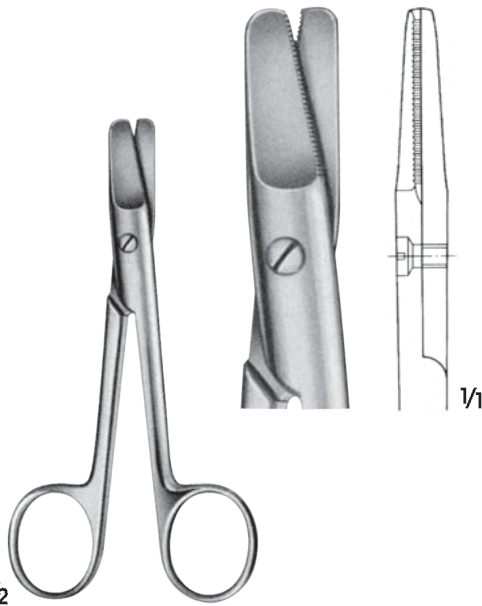

HARVEY
BC 666.00
Çift ağız tırtilli
Both jaws serrated
12.5 cm

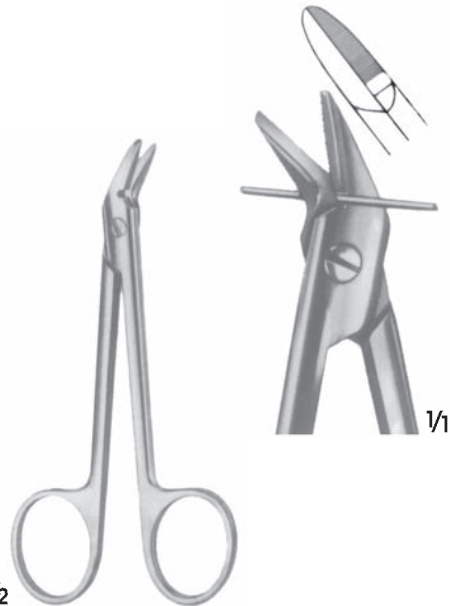

DP 668.00
Tek ağız tırtilli
One jaws serrated
12 cm



Karbür kesme ucu yerleştirilmiş HARDTIPS makaslar

- Mükemmel kesim
- Uzun çalışma ömrü

HARDTIPS scissors with inserted carbide cutting edges

- Excellent Cutting
- Long working

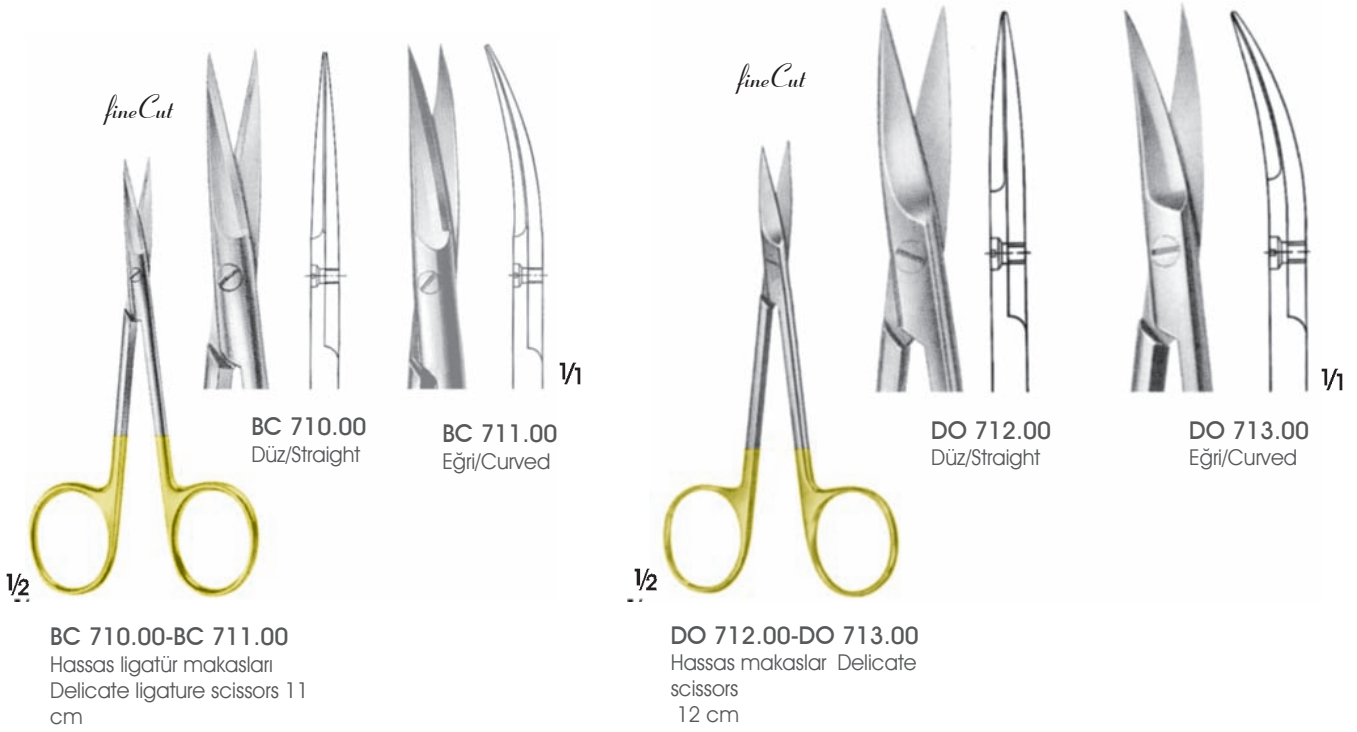

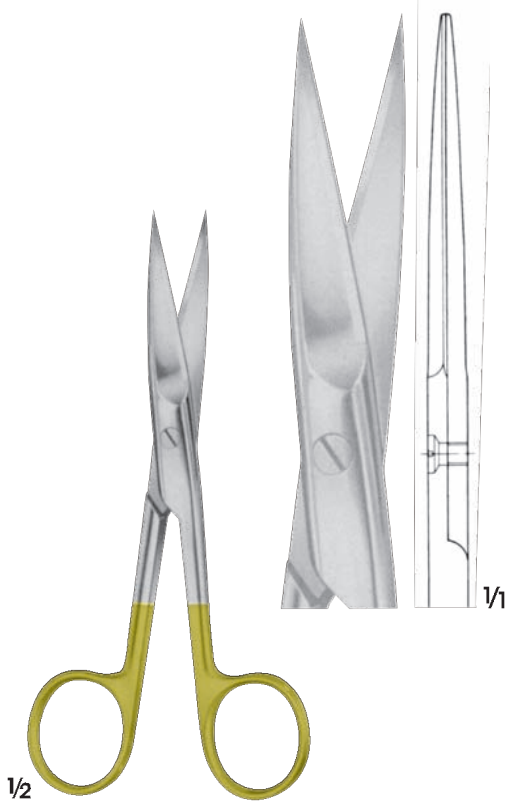

BC 722.00
 Cerrahi makas/Surgical scissors
 14.5 cm

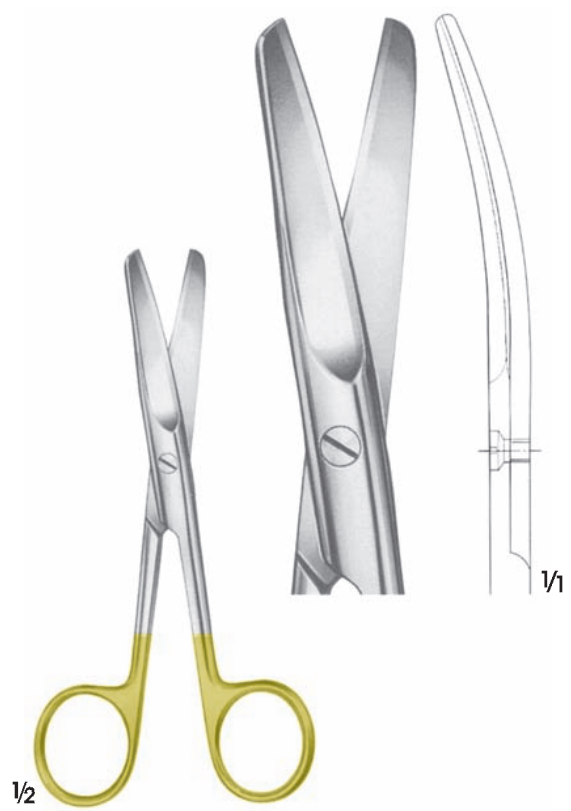

BC 723.03
 Cerrahi makas/Surgical scissors
 14.5 cm

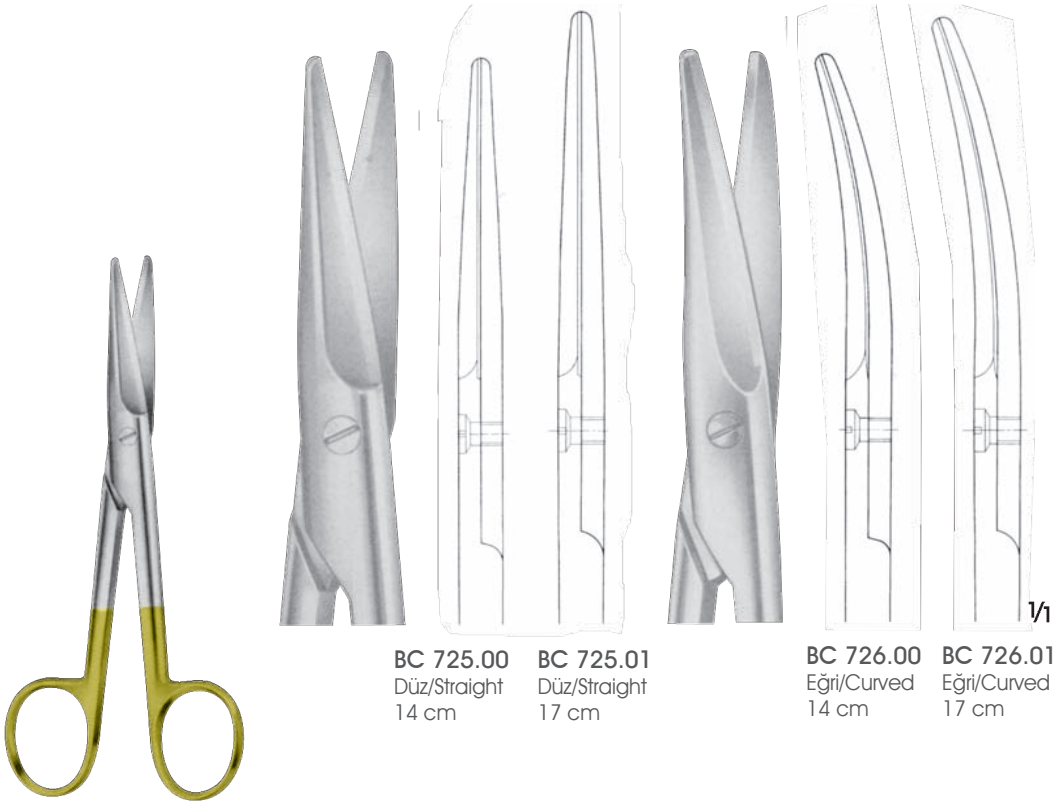

BC 725.00
 Düz/Straight
 14 cm

BC 725.01
 Düz/Straight
 17 cm

BC 726.00
 Eğri/Curved
 14 cm

BC 726.01
 Eğri/Curved
 17 cm

MAYO
BC 725.00-BC 726.01
 Diseksiyon makasları/Dissecting scissors



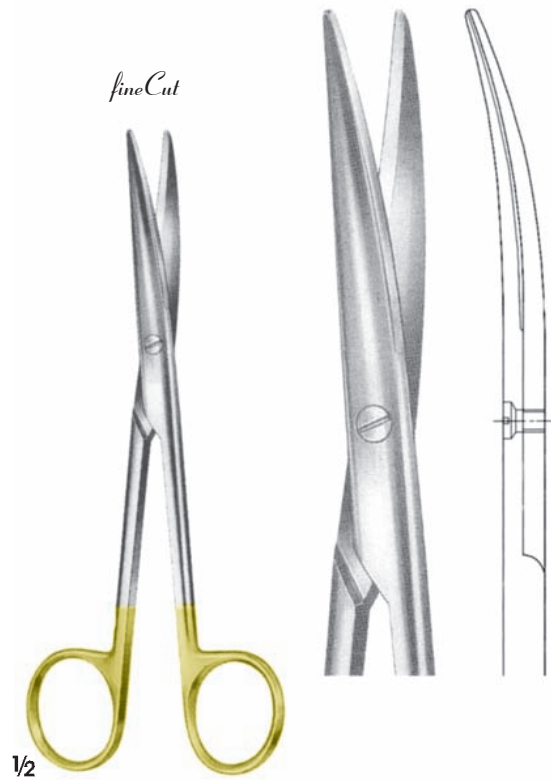

LEXER
BC 730.00
Dar/Narrow
16.5 cm

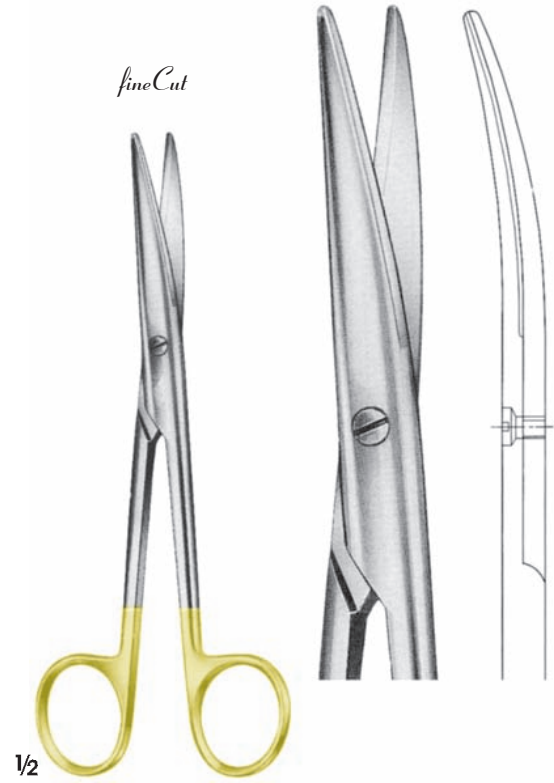

MAYO-LEXER
BC 731.00
16.5 cm

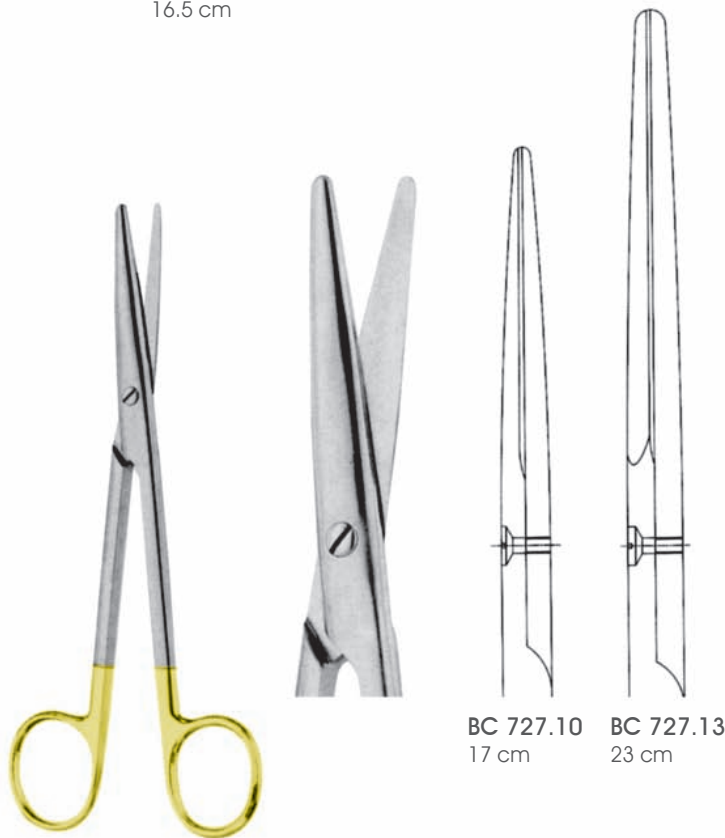

MAYO
BC 727.10-BC 728.13

BC 727.10 17 cm
BC 727.13 23 cm

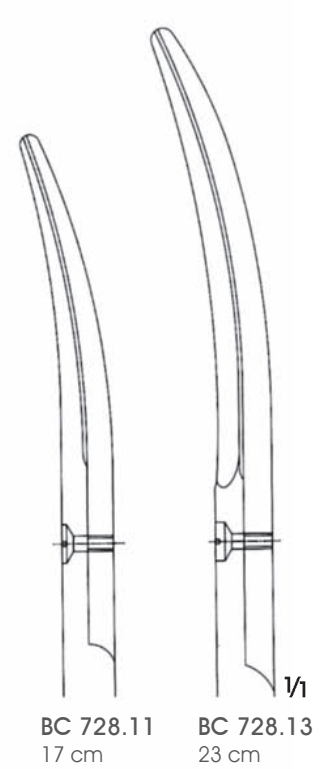

BC 728.11 17 cm
BC 728.13 23 cm

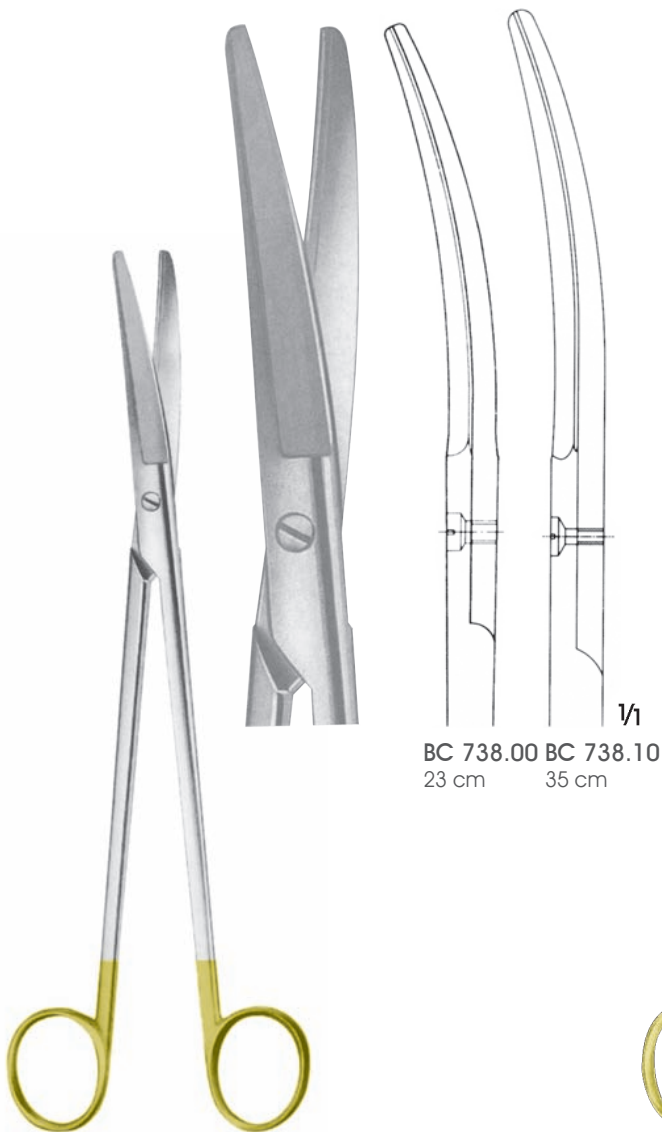
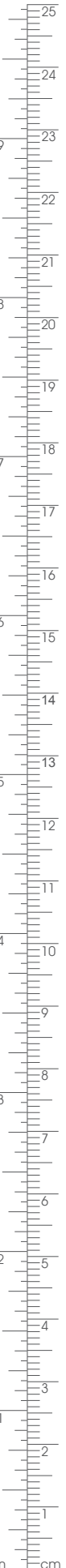

BC 738.00 BC 738.10
23 cm 35 cm

WERTHEIM
BC 738.00-BC 738.10
Diseksiyon makasları/Dissecting scissors

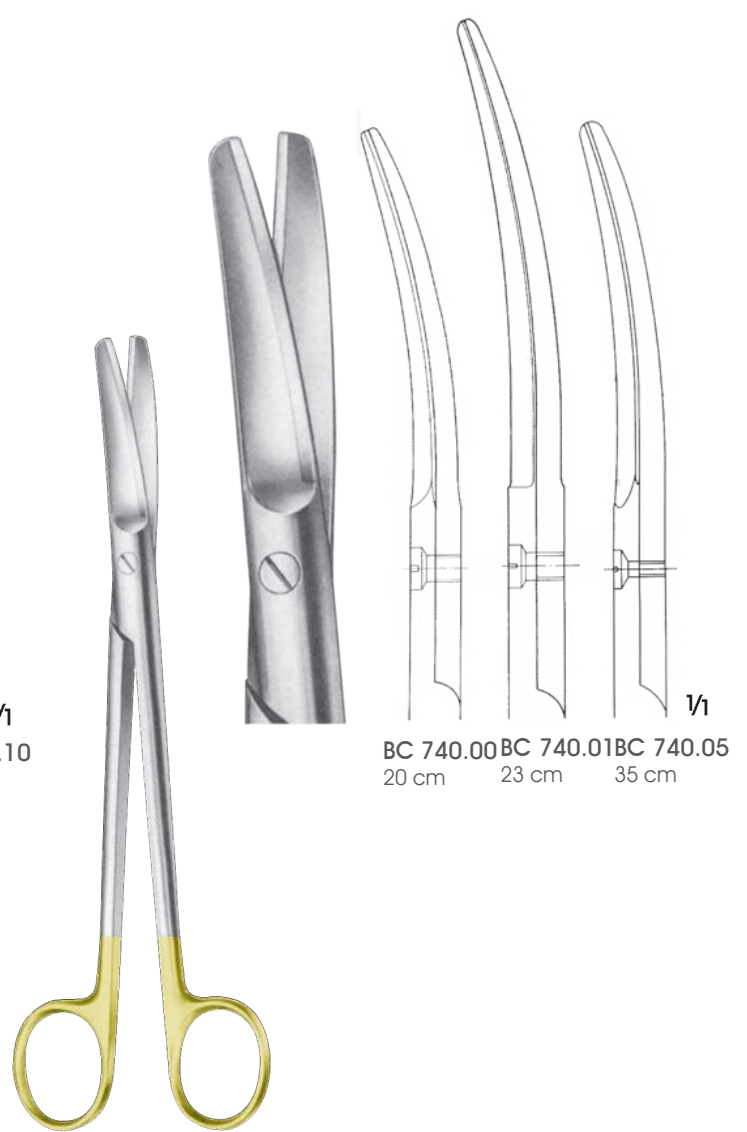

BC 740.00 BC 740.01 BC 740.05
20 cm 23 cm 35 cm

SIMS
BC 740.00-BC 740.05
Rahim makasları/Uterine Scissors

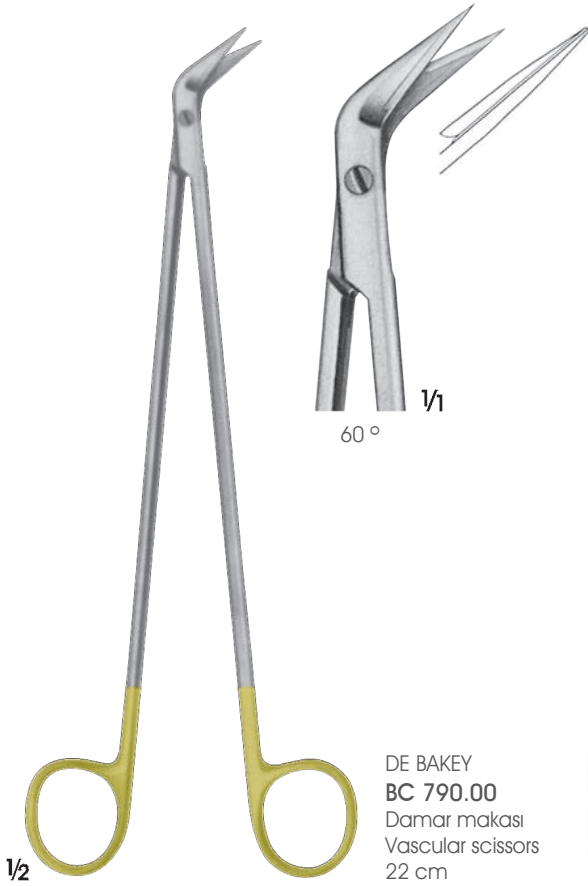
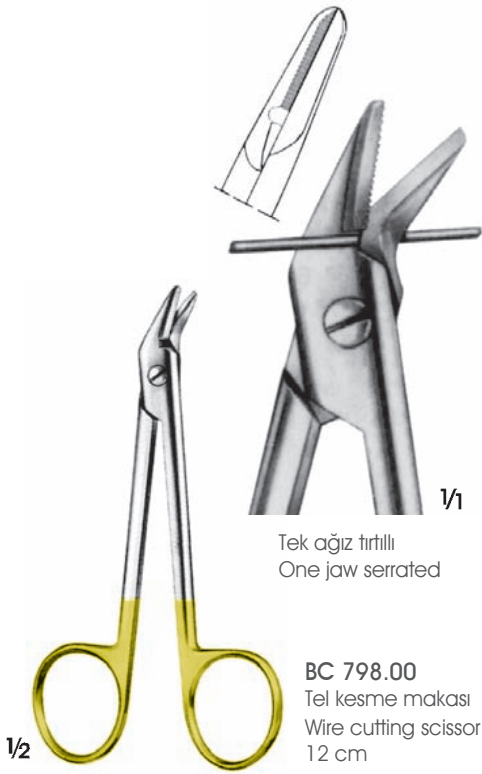

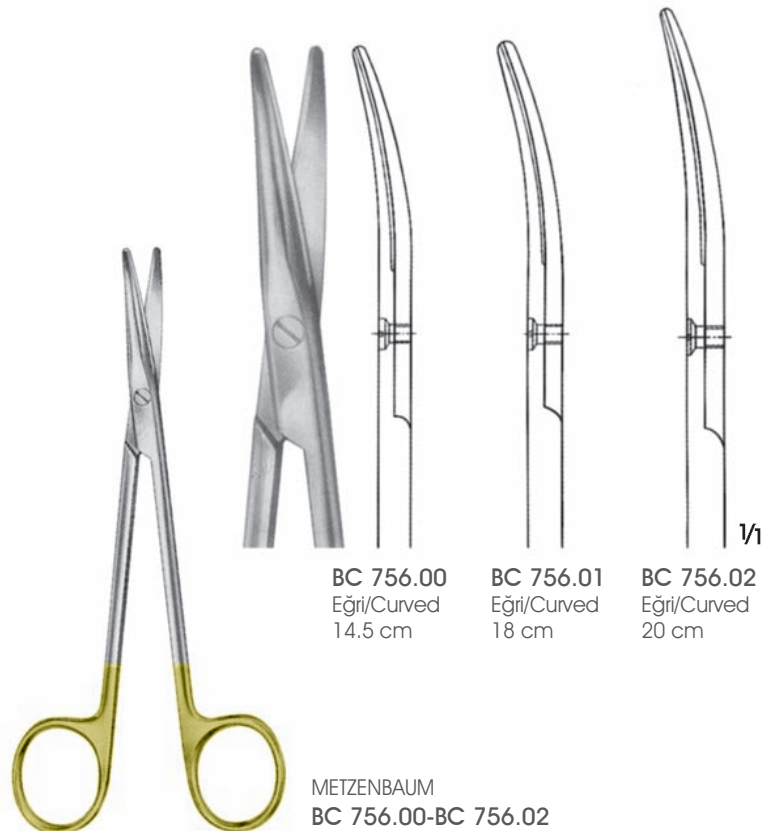
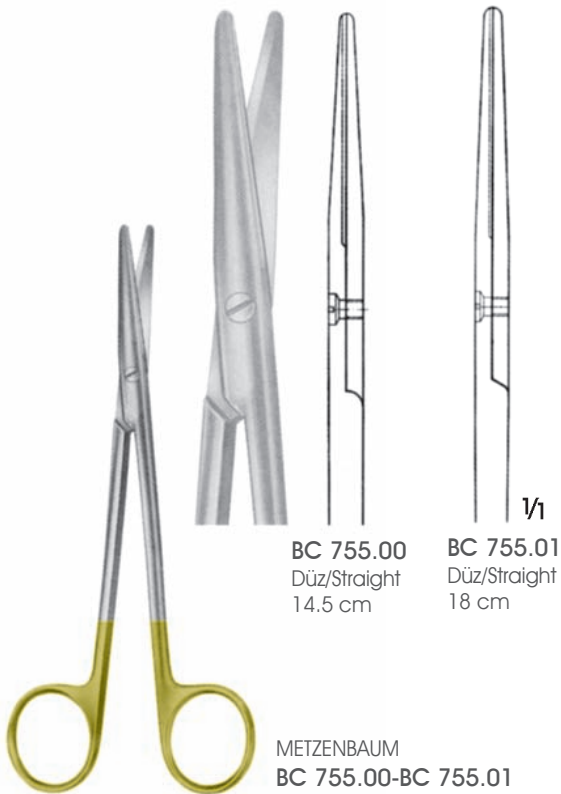



NELSON-METZENBAUM
BC 768.00-BC 768.02



BC 768.00
26 cm

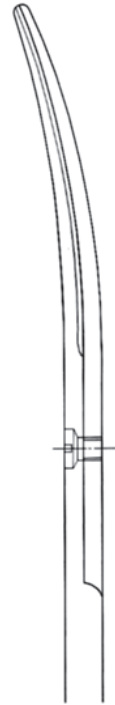

BC 768.01
28 cm



BC 768.02
28.5 cm $\frac{1}{1}$

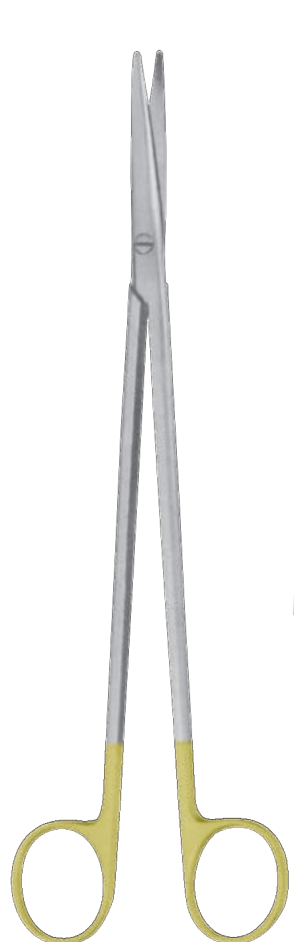

NELSON-METZENBAUM (MC INDOE)
BC 760.00-BC 761.01



BC 760.00
23 cm



BC 761.00
23 cm



BC 761.01
30 cm $\frac{1}{1}$

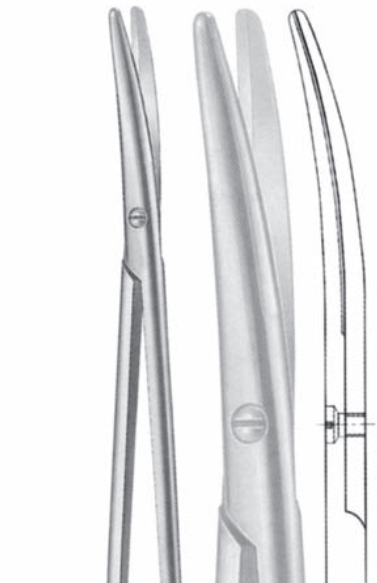

Geniş bleyd ucu
Broad blade ends

$\frac{1}{2}$

METZENBAUM
BC 766.00
23 cm

fineCut

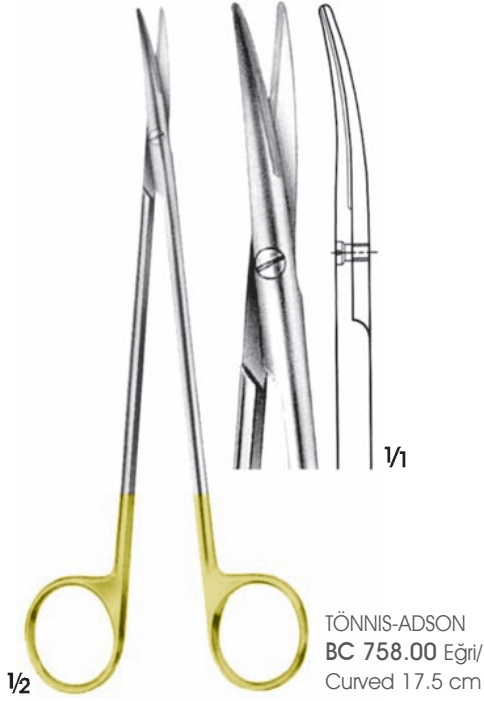

fineCut

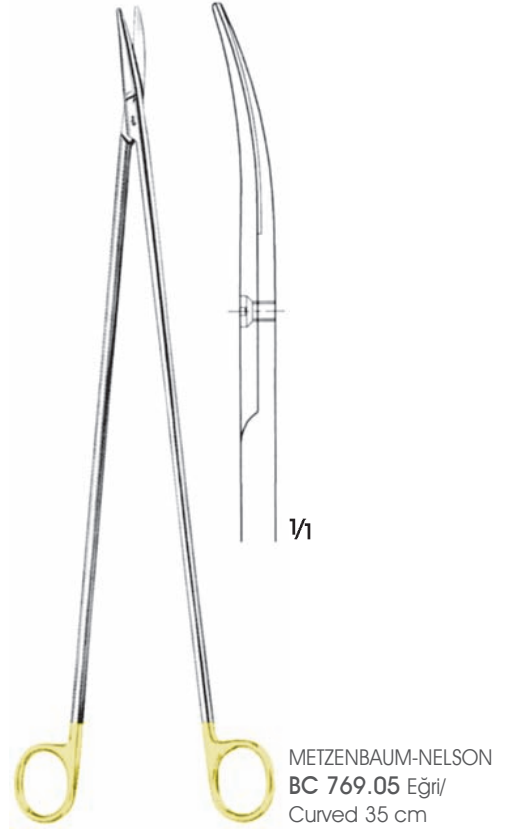

fineCut

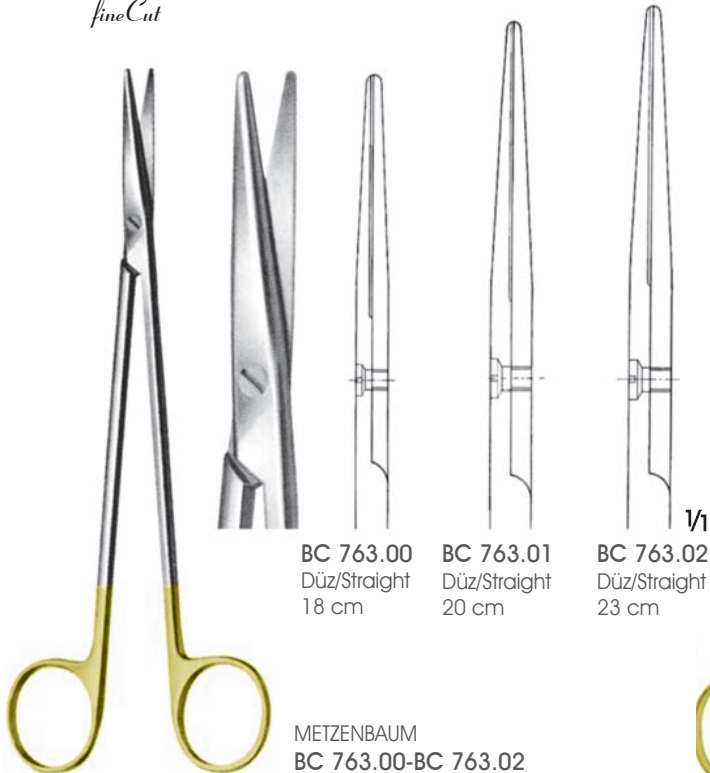

fineCut

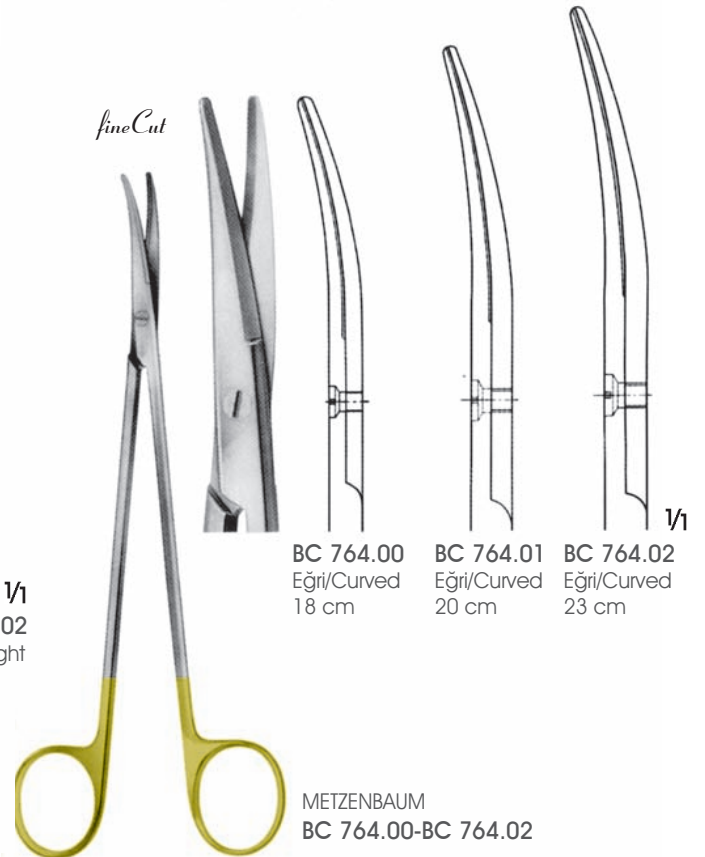



Dikiş malzemelerinin kesimi için ;

- GripCut makasın üzerindeki karbid uçları kalıcı keskinlik sağlar. (Makas ağzının uçları da dahil)
- GripCut makasın üzerindeki Tırtıklı ağız dikiş malzemelerinin dışarıya kaymasını engeller.

Cutting suture materials;

- Carbide inserts on GripCut scissors provide lasting sharpness. (including tip of the blades of the scissors)
- Serrated edges on GripCut scissors prevents suture materials from slipping out.

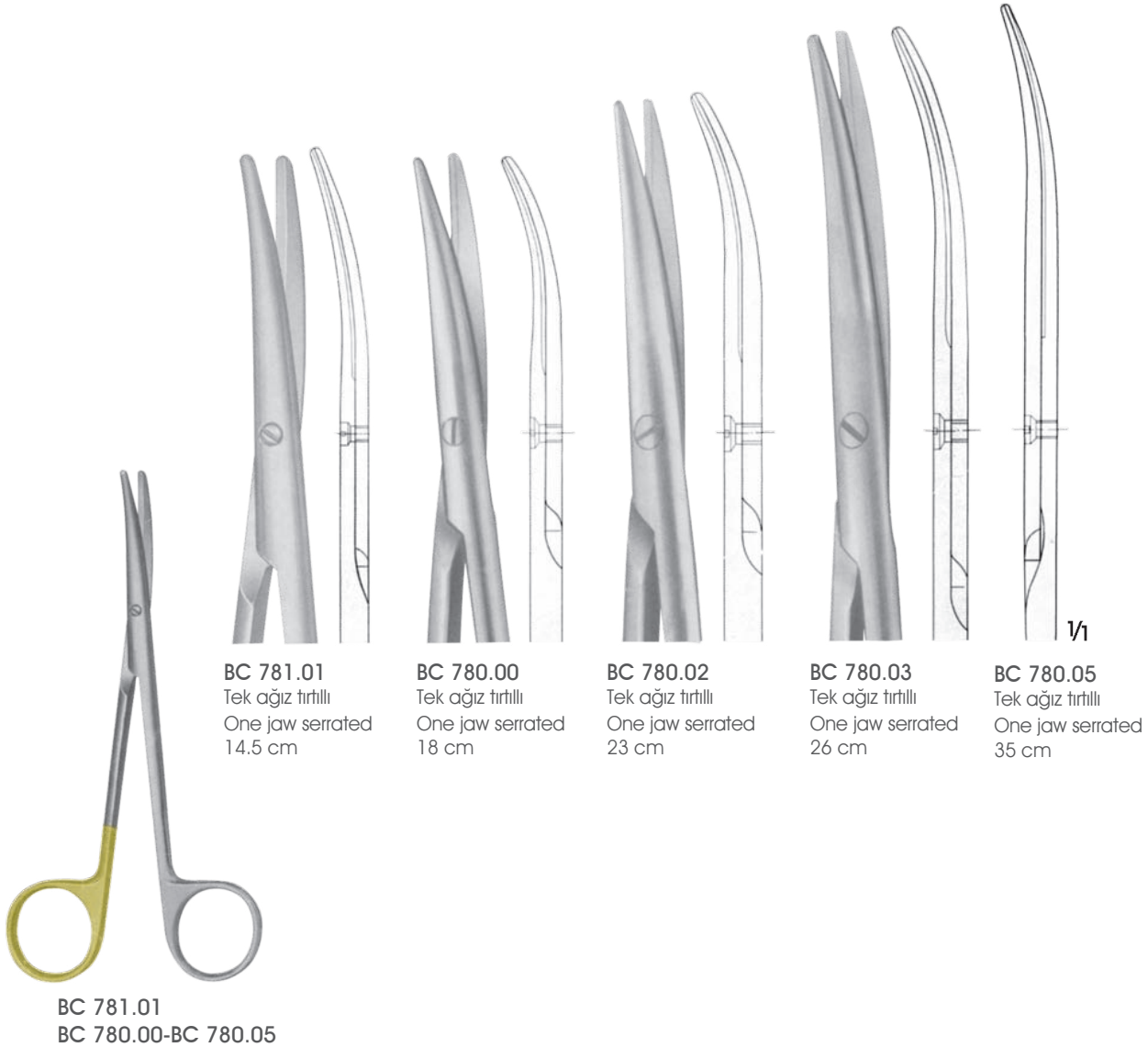

fineCut

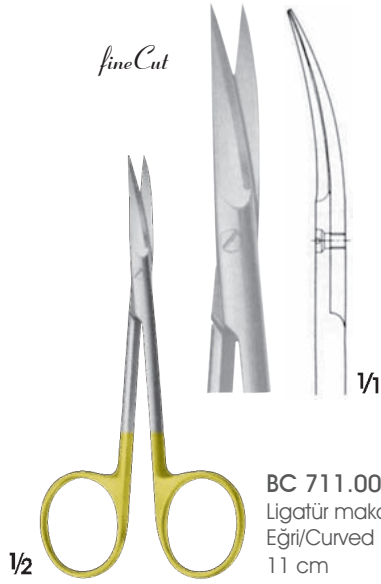

BC 711.00G
 Ligatür makası/Ligature scissors
 Eğri/Curved
 11 cm

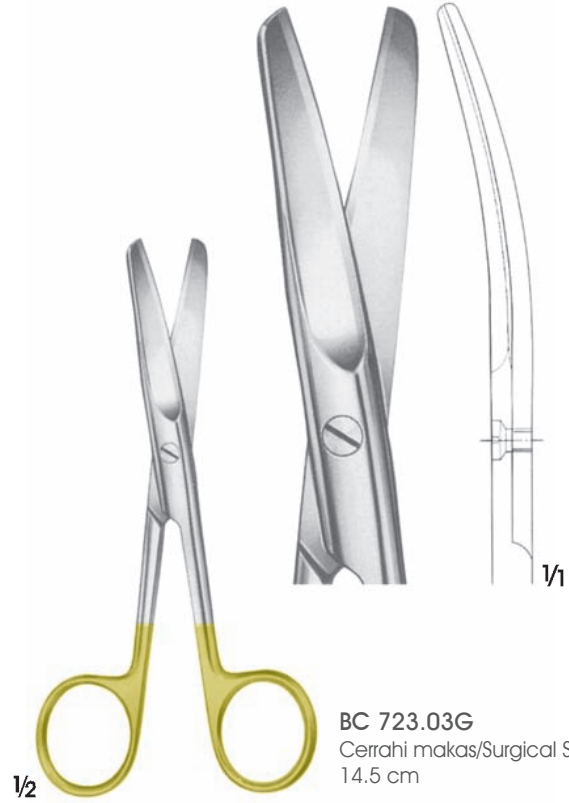

BC 723.03G
 Cerrahi makas/Surgical Scissors
 14.5 cm

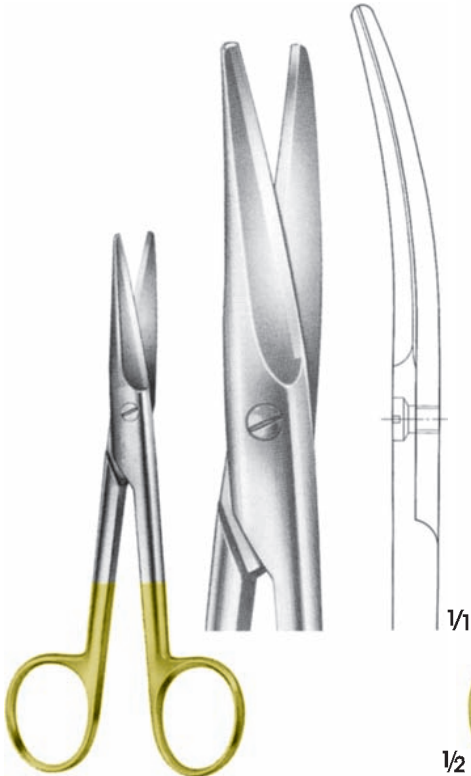

MAYO
BC 726.01G
 Diseksiyon makası
 Dissecting scissors
 17 cm

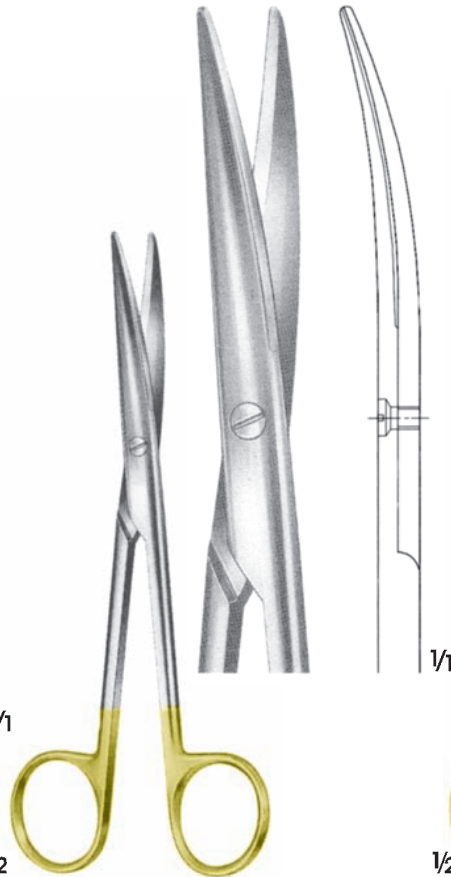

LEXER
BC 730.00G
 İnce diseksiyon makası
 Dissecting scissors, slender
 16.5 cm

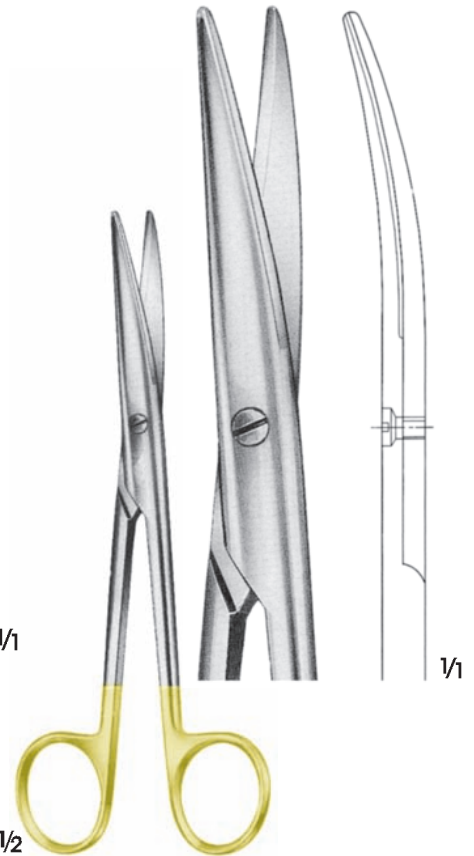

MAYO-LEXER
BC 731.00G
 Diseksiyon makası
 Dissecting scissors
 16.5 cm

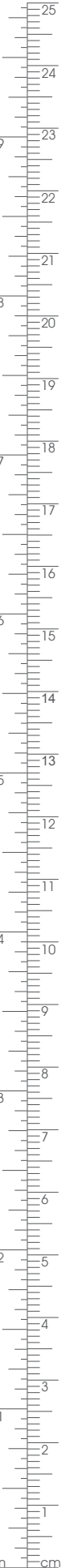

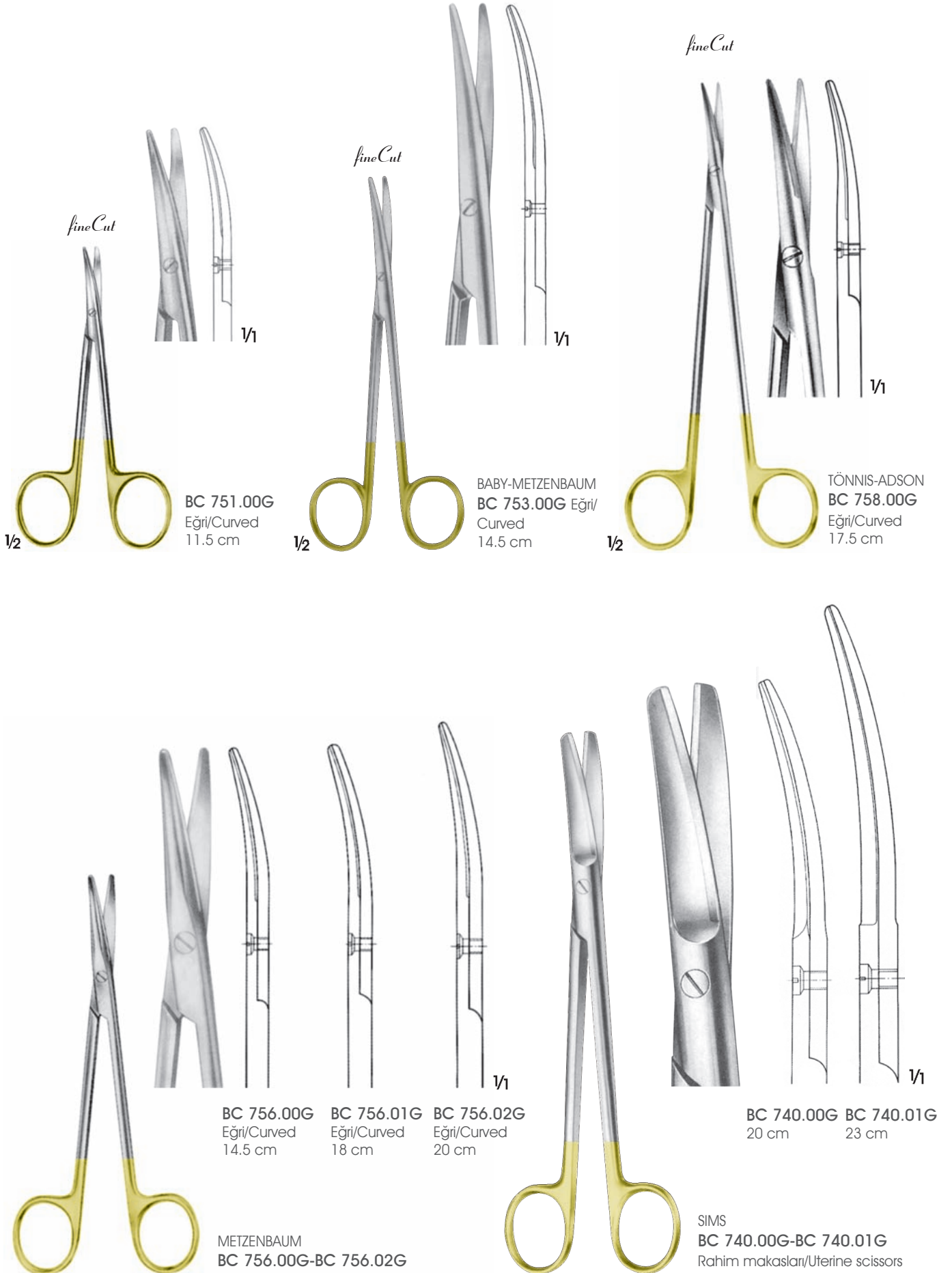

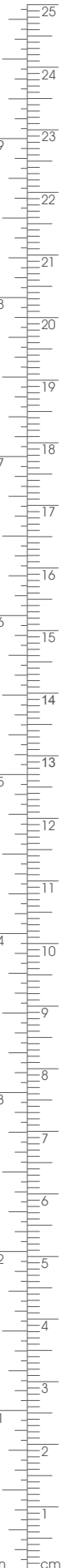
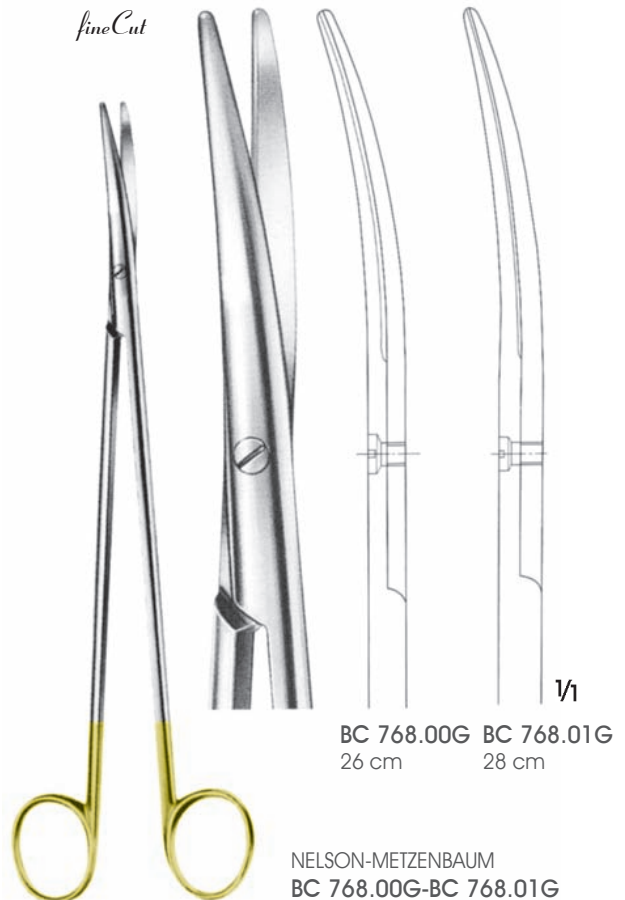
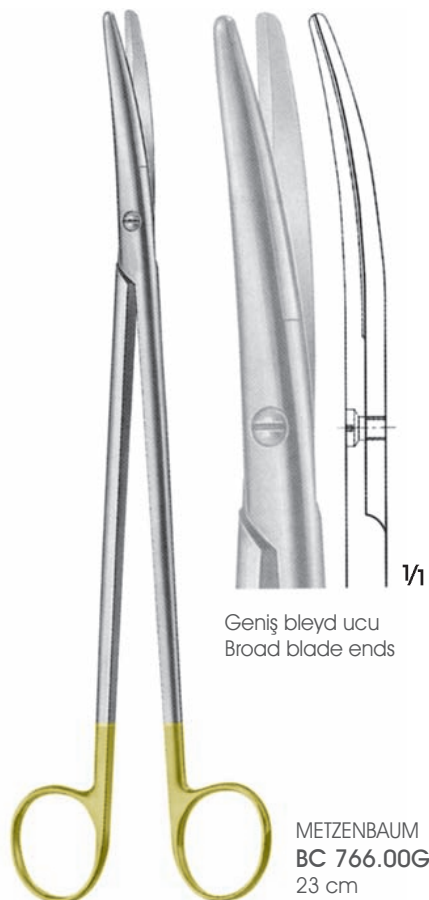
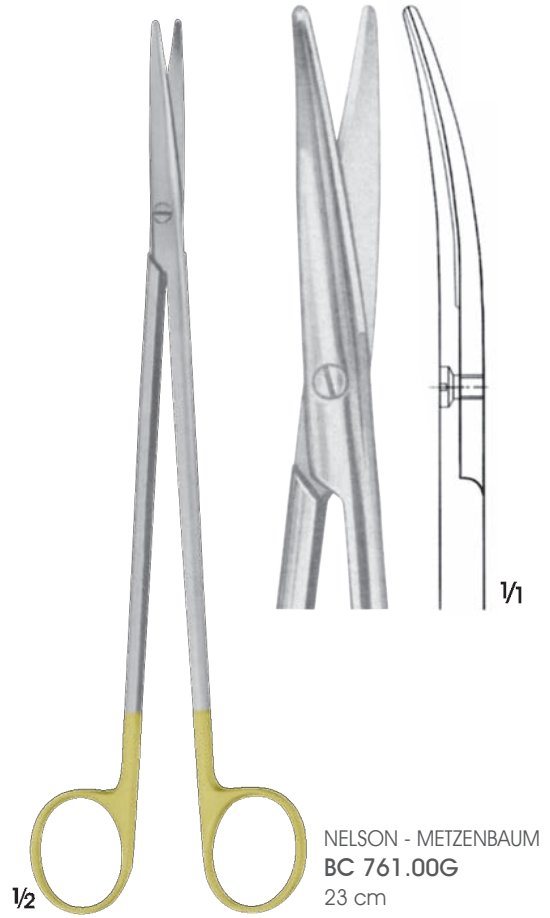



Dikiş malzemelerinin kesimi için ;

- *GripCut* makasın üzerindeki karbid uçları kalıcı keskinlik sağlar. (Makas ağzının uçları da dahil)
- *GripCut* makasın üzerindeki Tırtıklı ağız dikiş malzemelerinin dışarıya kaymasını engeller.

Cutting suture materials;

- Carbide inserts on *GripCut* scissors provide lasting sharpness. (including tip of the blades of the scissors)
- Serrated edges on *GripCut* scissors prevents suture materials from slipping out.

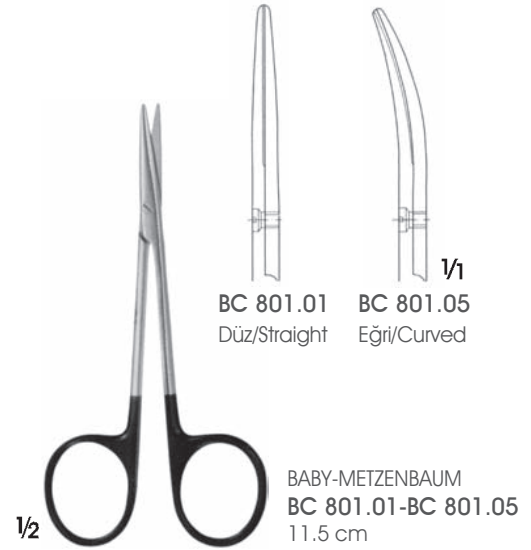
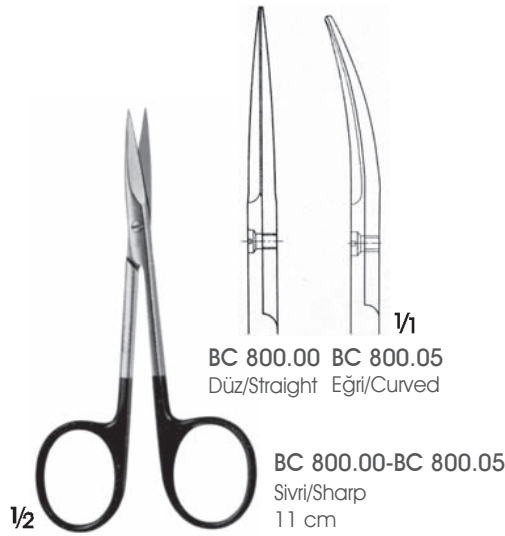

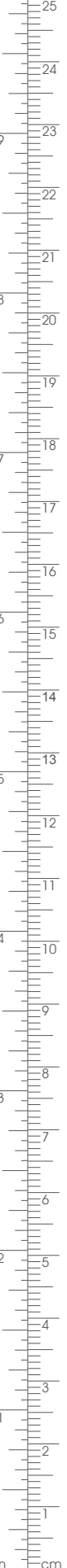
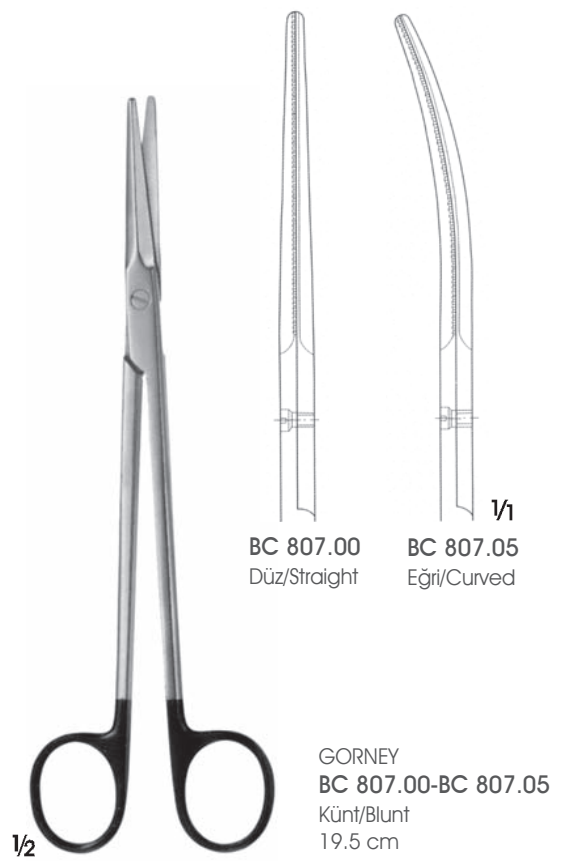

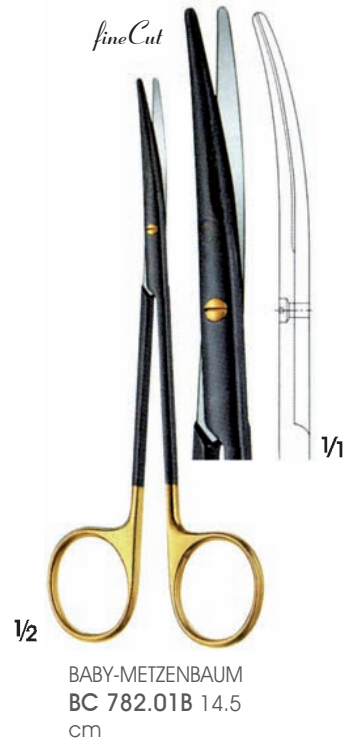

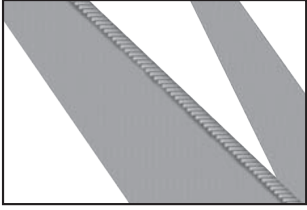

GripCut kesme sırasında dokunun kaymasını engeller.

GripCut prevents tissue from slipping out during the cutting process

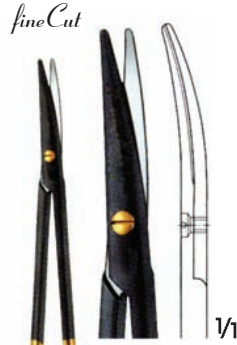

BC 790.01B
Tek ağız tırtıllı/One jaws serrated
11.5 cm

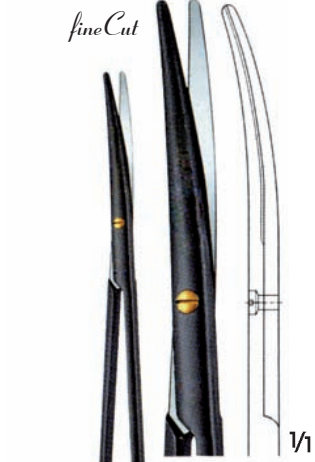

BC 792.01B
Tek ağız tırtıllı/One jaws serrated
14.5 cm



METZENBAUM
BC 793.01B-BC 793.14B
Tek ağız tırtıllı/One jaws serrated



MAYO-LEXER
BC 795.01B-BC 795.02B
Tek ağız tırtıllı/One jaws serrated



BD Pensetler
Forceps



 **ARGENT**

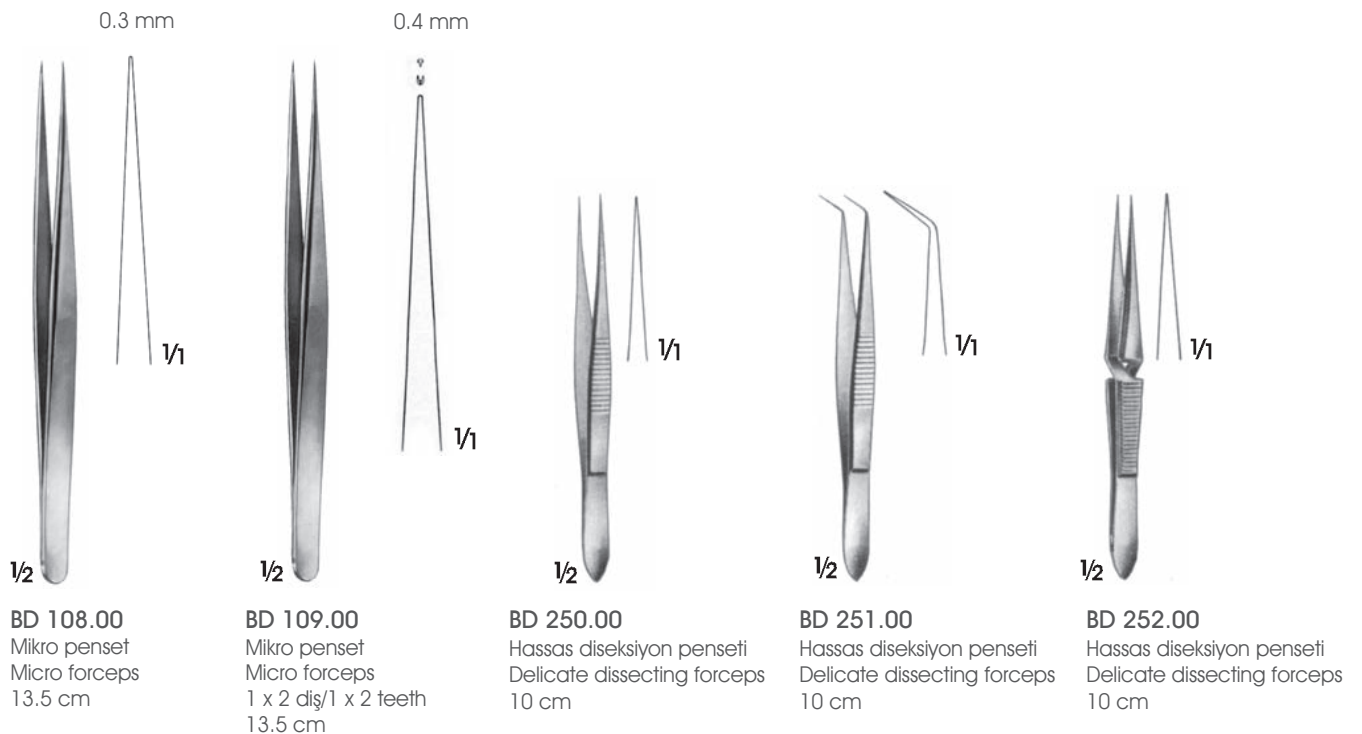
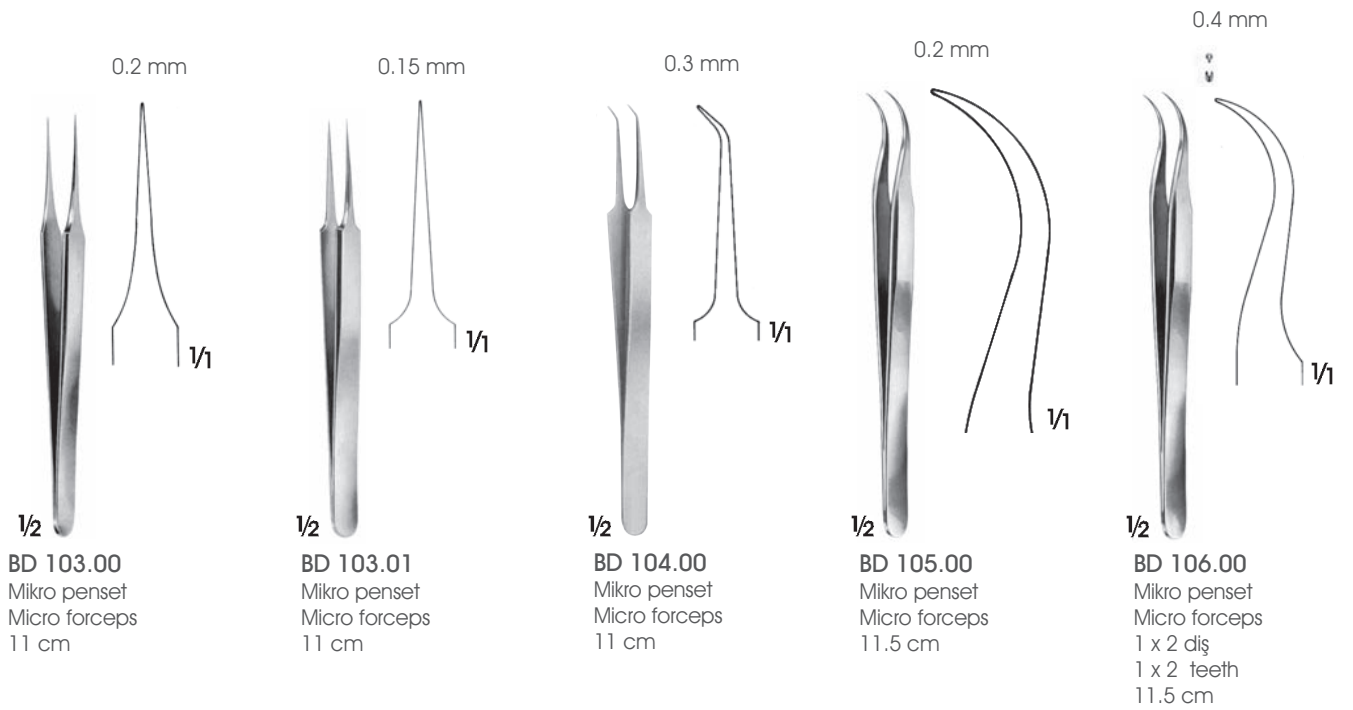

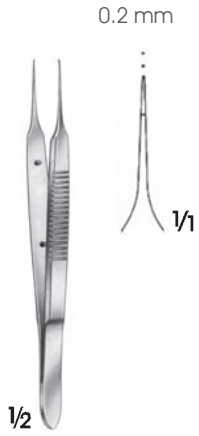

BONNER MODELL
BD 124.00
1 x 2 dişli platform
With plateau 1 x 2 teeth
9.5 cm



BD 107.00
12 cm



VISE
BD 110.00
13.5 cm



VISE
BD 113.00
13.5 cm

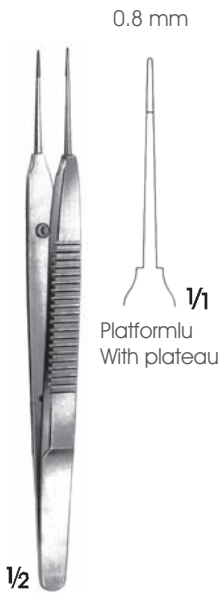

AUSTIN
BD 125.00
14 cm

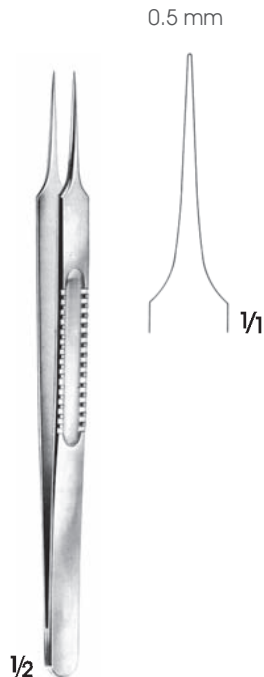

LAZAR
BD 127.00
15.5 cm

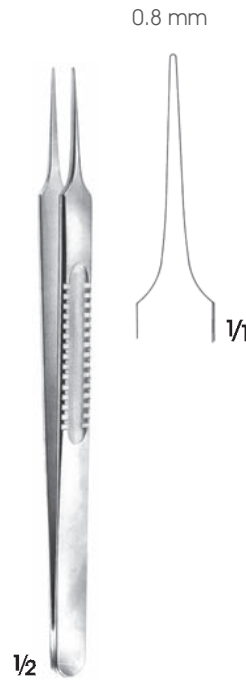

LAZAR
BD 128.00
15.5 cm

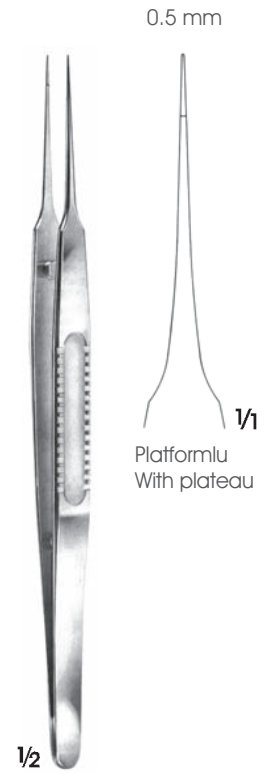

BD 126.00
18.5 cm



Kavrama yüzeyini artıran hafif plastik tutamak :

- Kramp oluşturmeyen, doğal tutma pozisyonu ve duyarlılık sağlar.
- Yuvarlak tutma kesiti aletin kolay ve düzgün rotasyonunu sağlar. Böylelikle uygulama ve çalışma alanı genişler.
- Pimli tutma profili güvenli tutmayı garanti eder.
- Ergonomik, hafif plastik sap yorulmadan optimum kullanım sağlar.

Lightweigh plastic handles to increase grip surface:

- Provides cramp free ,natural holding positions and sensitivity
- Round cross-section of the instrument provides an easy and smooth rotation.Expands the working and application area.
- Retention profile with pin ensures safe gripping.
- Ergonomic, light weight plastic handle provides fatigue free, optimal usage.

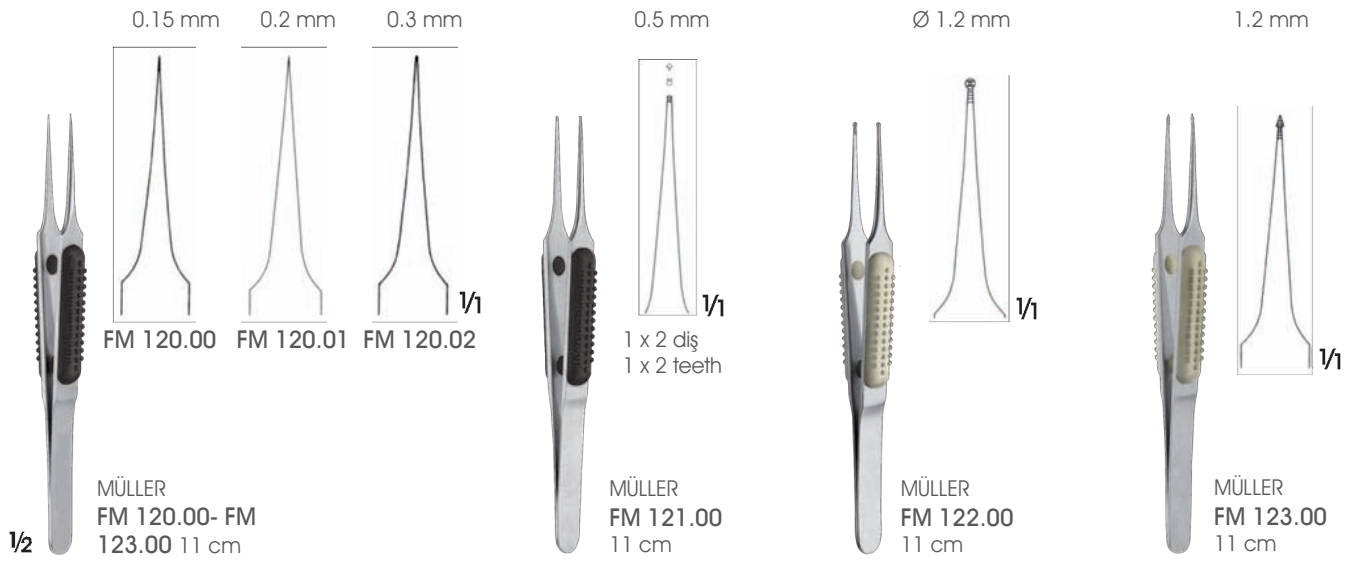

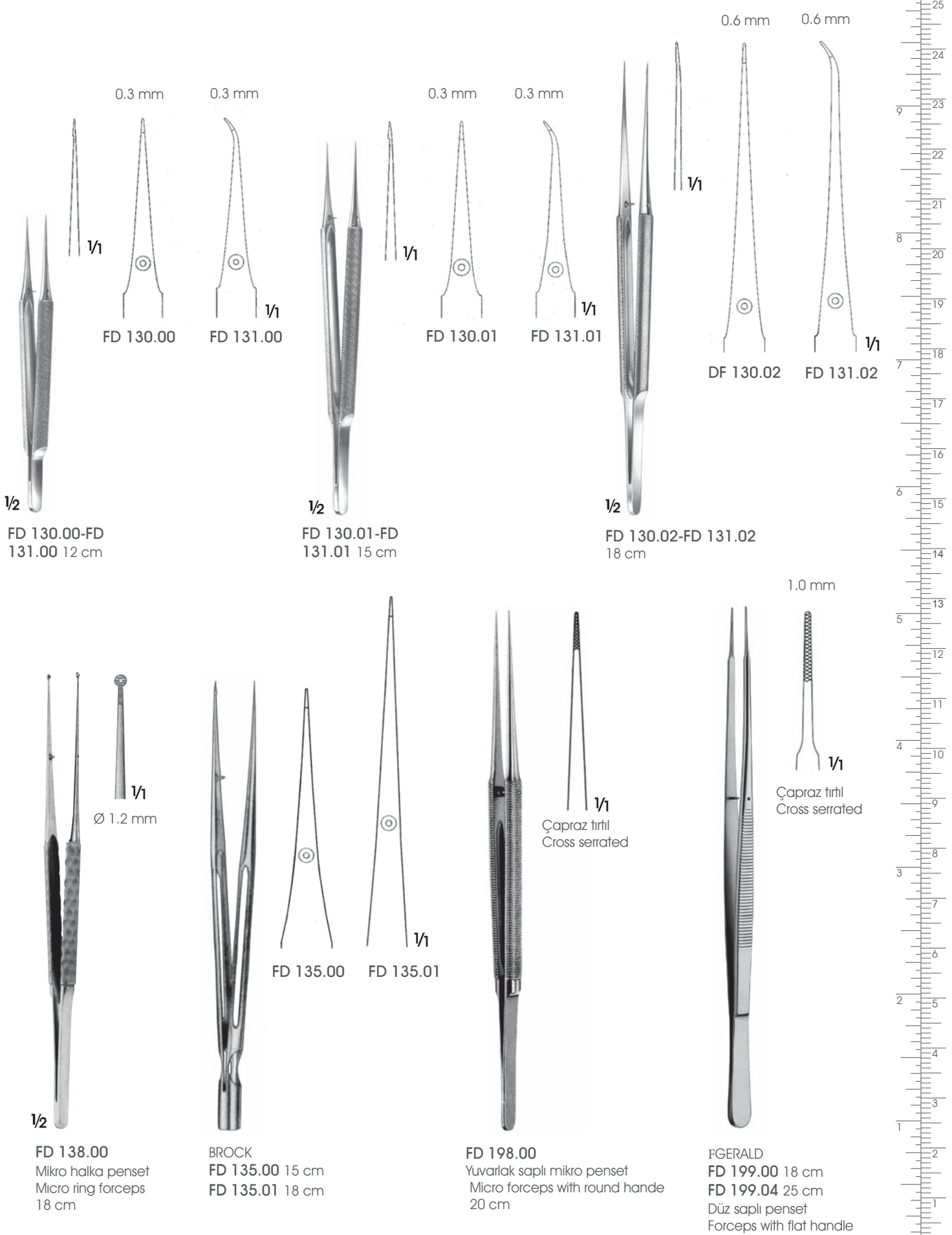

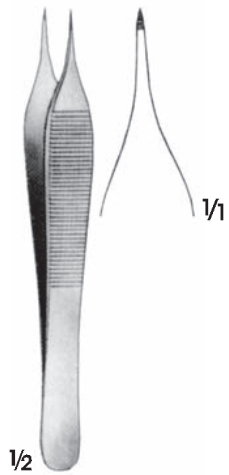

1/2
THORPE
OC 203.00
Korneal penset
Corneal forceps
12 cm



1/2
MICRO-ADSON
BD 204.00
12 cm

Platformlu
With plateau



1/2
ADSON
BD 205.00
12 cm

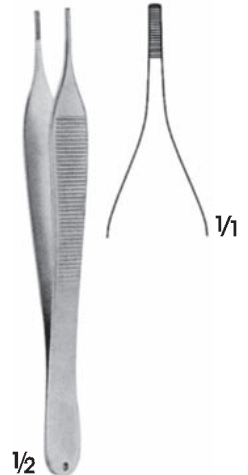

1/2
HUDSON
D 206.00
12.5 cm



1/2
MICRO-ADSON
BD 207.00
15 cm



1/2
ADSON
BD 213.00
18 cm

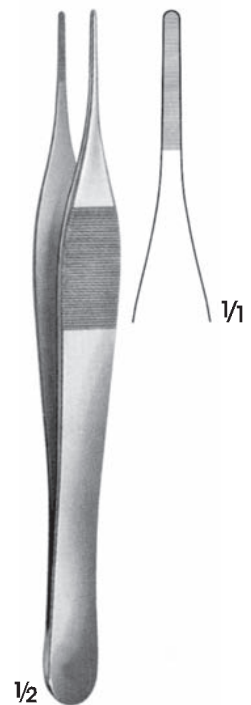

1/2
JEFFERSON
BD 214.00
18 cm

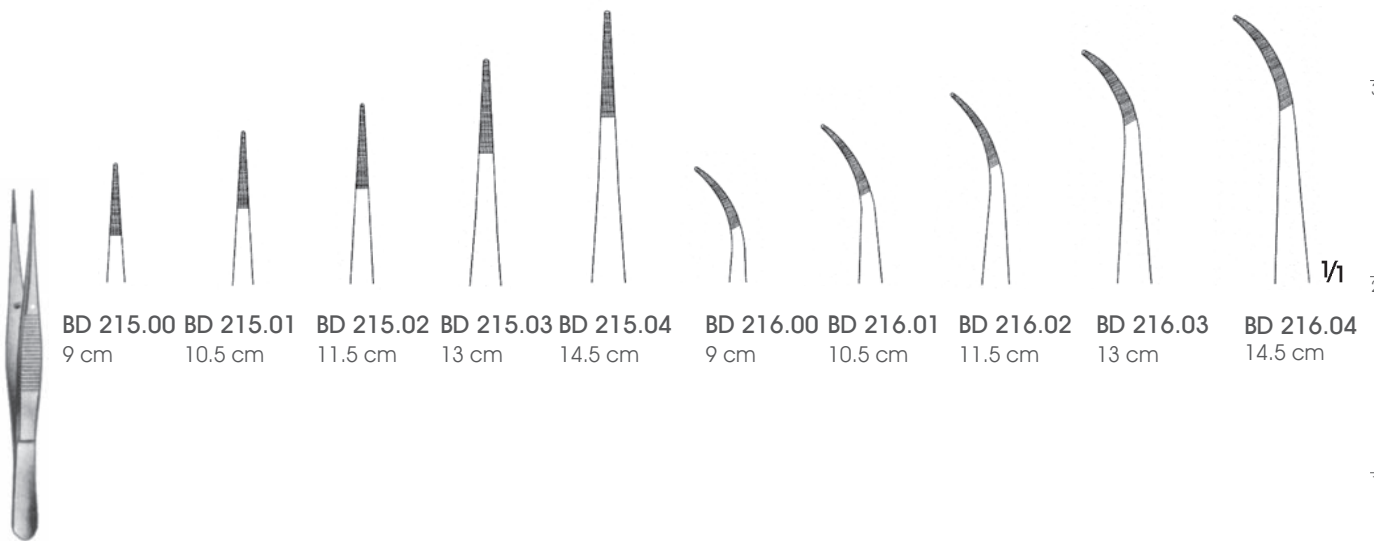
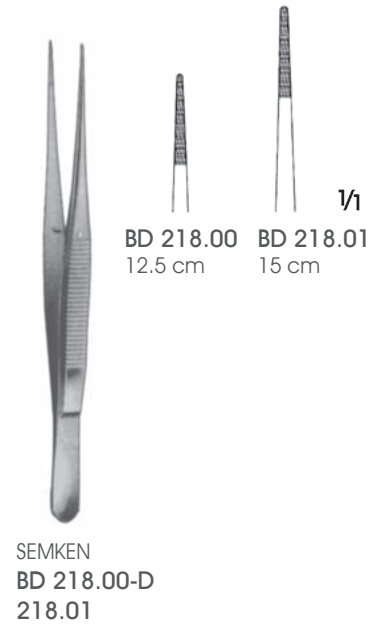
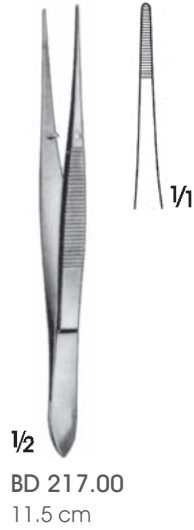
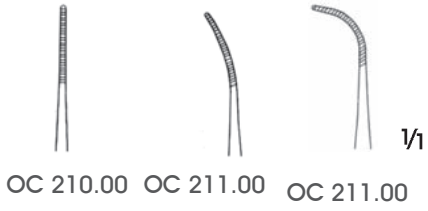

BD 215.00-BD 215.04 BD
216.00-D 216.04

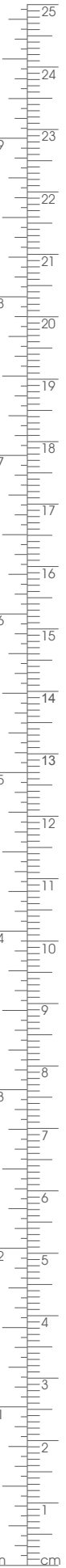

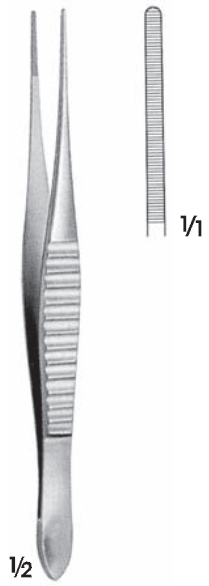

$\frac{1}{2}$
GILLIES
BD 227.00
15 cm

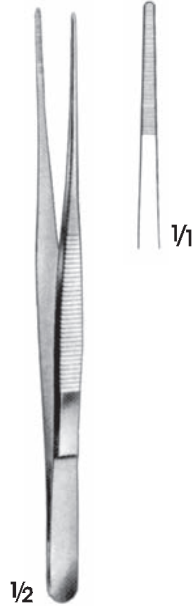

$\frac{1}{2}$
BD 219.00
15.5 cm

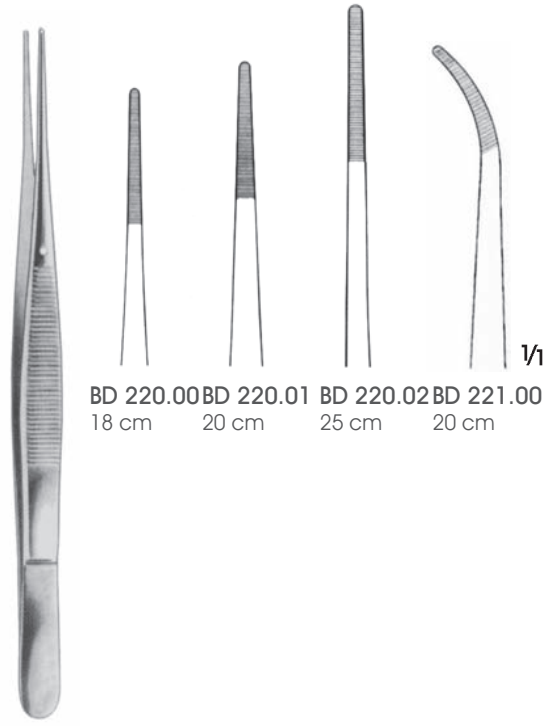

CUSHING
BD 220.00-BD 221.00

BD 220.00 18 cm
BD 220.01 20 cm
BD 220.02 25 cm
BD 221.00 20 cm

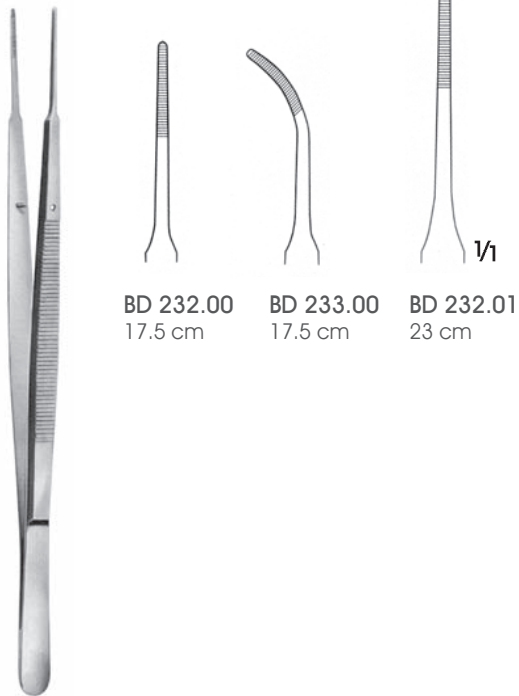

GERALD
BD 232.00-BD 233.00

BD 232.00 17.5 cm
BD 233.00 17.5 cm
BD 232.01 23 cm

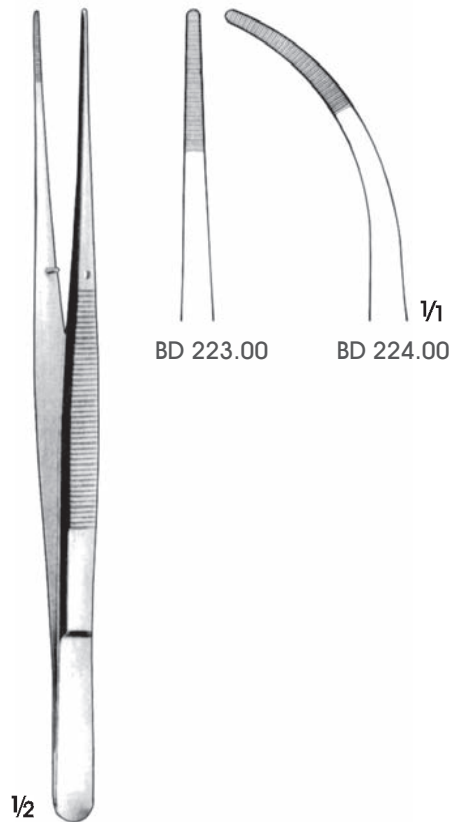

$\frac{1}{2}$
BROPHY
BD 223.00-BD 224.00
20 cm

BD 223.00
BD 224.00

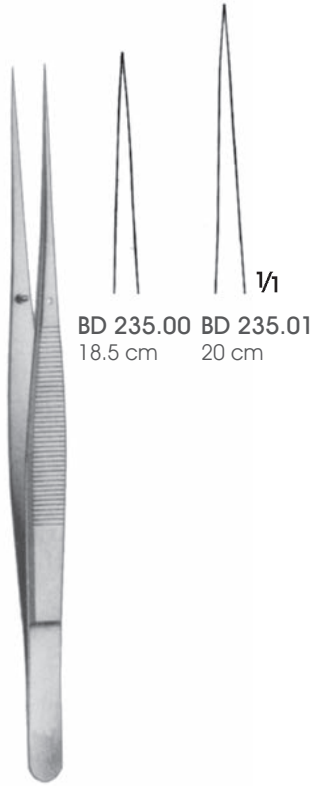

BD 235.00-BD 235.01
Düz Ağız/Smooth jaws



COOLEY
BD 222.00
20 cm

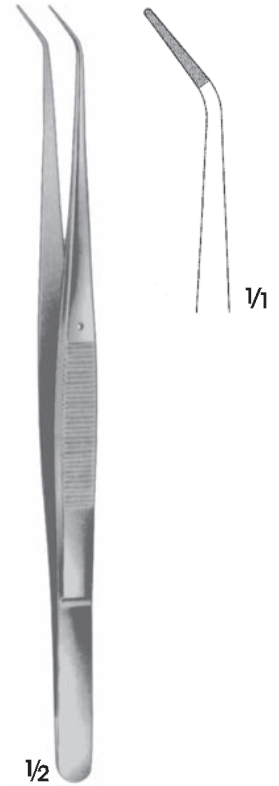

BD 236.00
20 cm

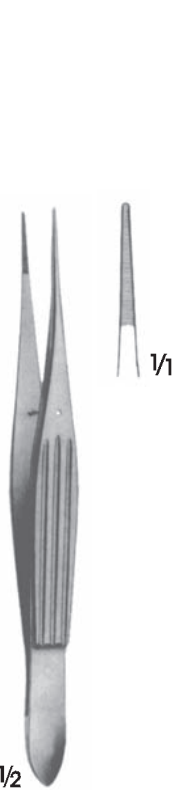

MC INDOE
BD 230.00
15 cm



CAIRNS-DOTT
BD 239.00-BD 239.01

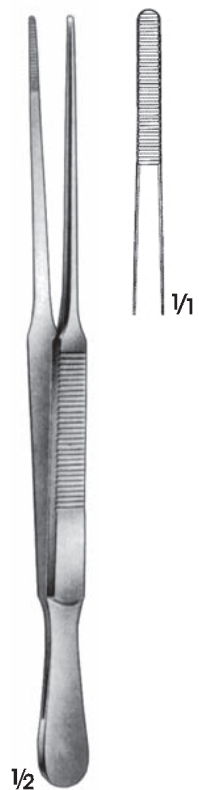

BD 238.00
20 cm

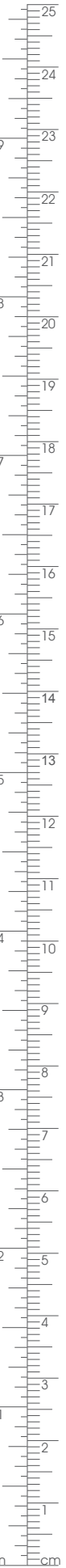

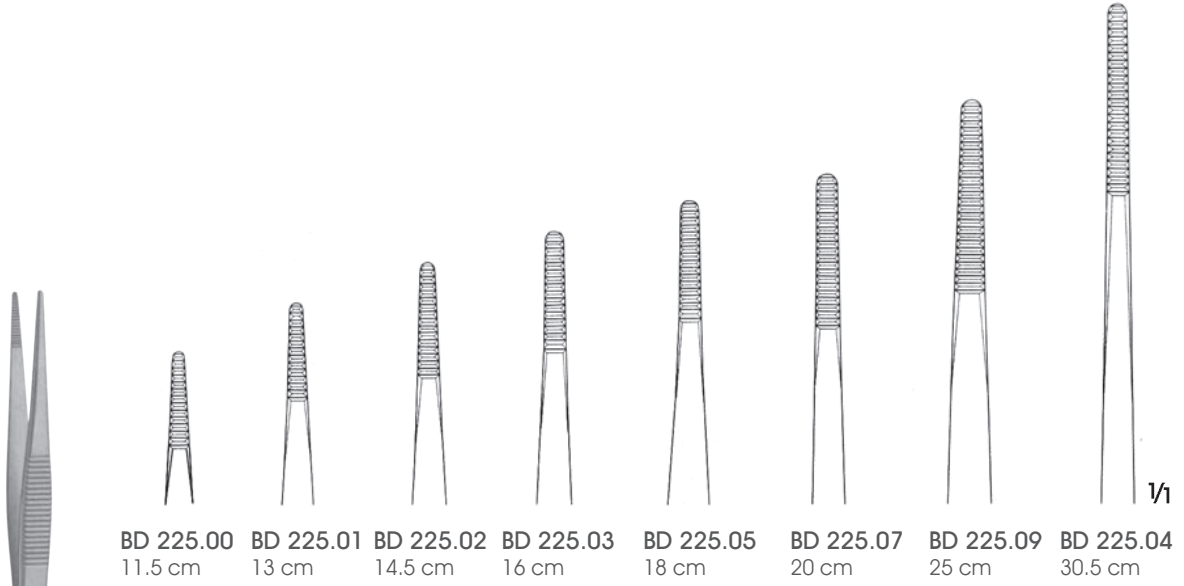

BD 225.00 11.5 cm BD 225.01 13 cm BD 225.02 14.5 cm BD 225.03 16 cm BD 225.05 18 cm BD 225.07 20 cm BD 225.09 25 cm BD 225.04 30.5 cm

BD 225.00-BD 225.09
Orta/Medium

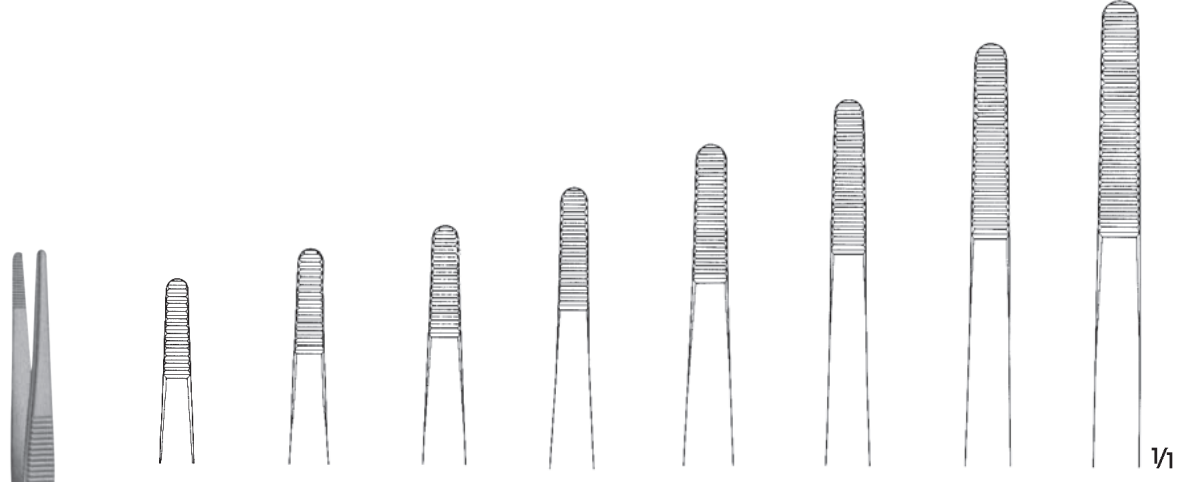

BD 240.00 11.5 cm BD 240.01 13 cm BD 240.02 14.5 cm BD 240.03 16 cm BD 240.04 18 cm BD 240.05 20 cm BD 240.06 25 cm BD 240.07 30 cm

BD 240.00-BD 240.07
Standart model/Standard pattern

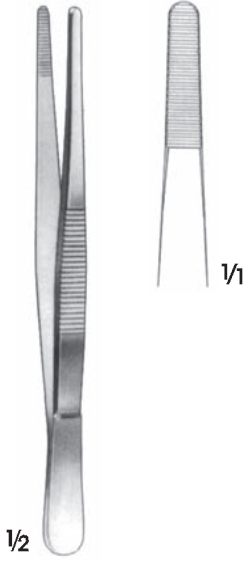

BD 242.00
Çok büyük/Extra Large
Diseksiyon penseti
Dissecting forceps
14.5 cm

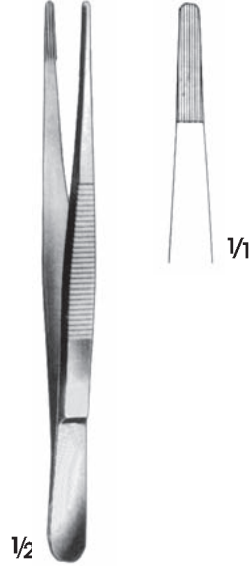

OCHSNER
BD 247.00
Ligatür penseti
Ligature forceps
14.5 cm

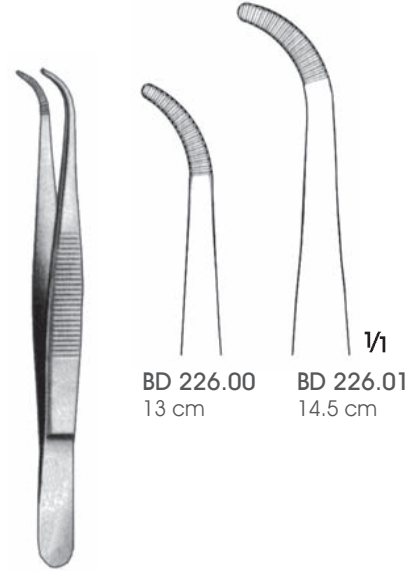

BD 226.00-BD 226.01
Orta/Medium Diseksiyon
pensetleri Dissecting forceps

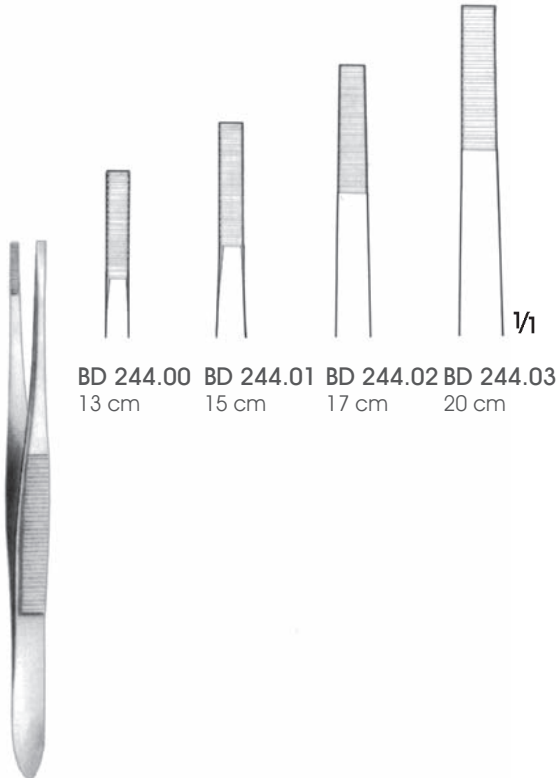

SCHWEDISCHES MODELL
BD 244.00-BD 244.03
Diseksiyon pensetleri
Dissecting forceps



BONNEY
BD 248.00
Diseksiyon penseti
Dissecting forceps
17.5 cm

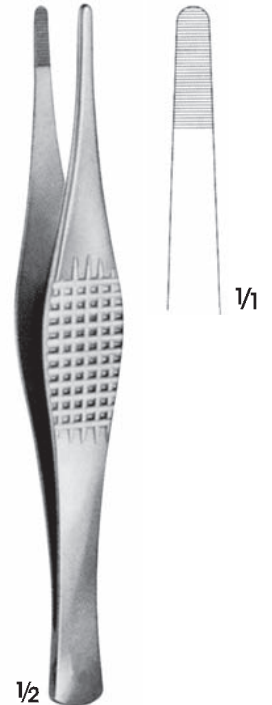

RAMSEY
BD 245.00
Diseksiyon penseti
Dissecting forceps
18 cm



De Bakey Diş



Toothing De Bakey

1.0 mm



DE BAKEY
BD 257.00 18.5 cm
BD 257.01 21 cm
Yuvarlak Saplı Mikro
pensetler Micro
forceps With round
handle

1.0 mm



DE BAKEY
BD 258.03 18.5 cm
BD 258.04 21 cm
Yuvarlak saplı Mikro
pensetler Micro
forceps With round
handle

1.0 mm



DE BAKEY
BD 256.01 18 cm
BD 256.02 20 cm
Düz saplı
Mikro penset Micro
forceps With round
handle

1.0 mm



DE BAKEY
FB 267.00 15 cm
FB 267.01 19.5 cm
FB 267.02 24 cm
Penset/forceps

1.5 mm

2 mm



DE BAKEY
FB 268.00 15
cm Penset/
forceps

1/1

2.3 mm

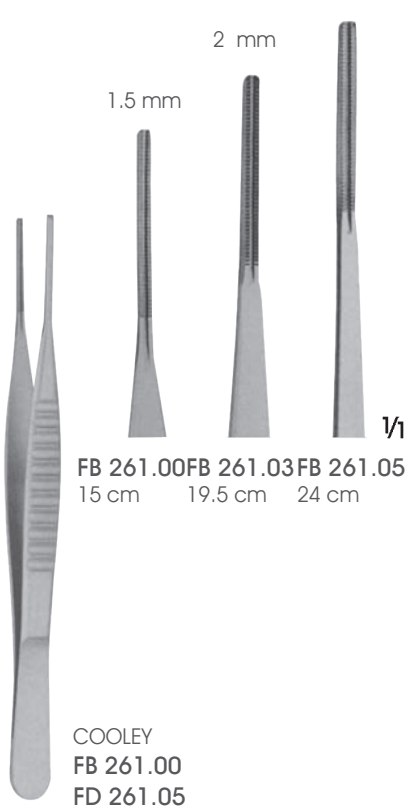

FB 261.00 15 cm
FB 261.03 19.5 cm
FB 261.05 24 cm

COOLEY
FB 261.00
FD 261.05
Pensetler/forceps

2 mm

1.5 mm

1/1

1.2 mm

1.5 mm

1.5 mm

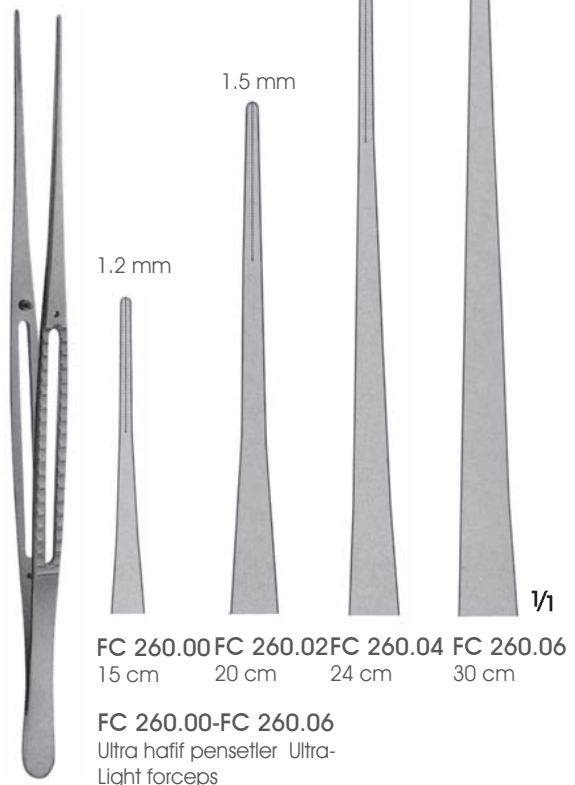

FC 260.00 15 cm
FC 260.02 20 cm
FC 260.04 24 cm
FC 260.06 30 cm

FC 260.00-FC 260.06
Ultra hafif pensetler Ultra-
Light forceps

1/1

De Bakey Diş



Toothing De Bakey

2.8 mm
2.8 mm
2.8 mm
2.8 mm

FB 263.00 15 cm
FB 263.01 20 cm
FB 263.02 24 cm
FB 263.03 30 cm

DE BAKEY
FB 263.00-FB 263.03

3.3 mm
3.5 mm
3.5 mm
3.5 mm

FB 266.00 20 cm
FB 266.01 24 cm
FB 266.02 30 cm
FB 266.03 35 cm

DE BAKEY
FB 266.00-FB 266.03

2 mm
2 mm
2 mm
2 mm

FB 262.00 15 cm
FB 262.01 20 cm
FB 262.02 24 cm
FB 262.03 30 cm

DE BAKEY
FB 262.00-FB 262.03

1.5 mm
1.5 mm
1.5 mm
1.5 mm

FB 265.00 15 cm
FB 265.01 20 cm
FB 265.02 1 x 2 diş
1 x 2 teeth
24 cm
FB 265.03 1 x 2 diş
1 x 2 teeth
30 cm

DE BAKEY
FB 265.00-FB 265.03

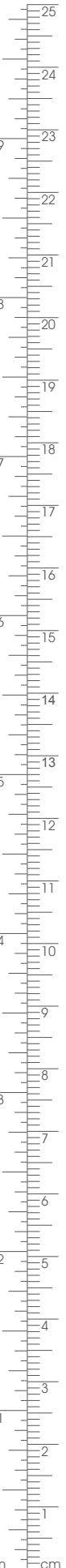

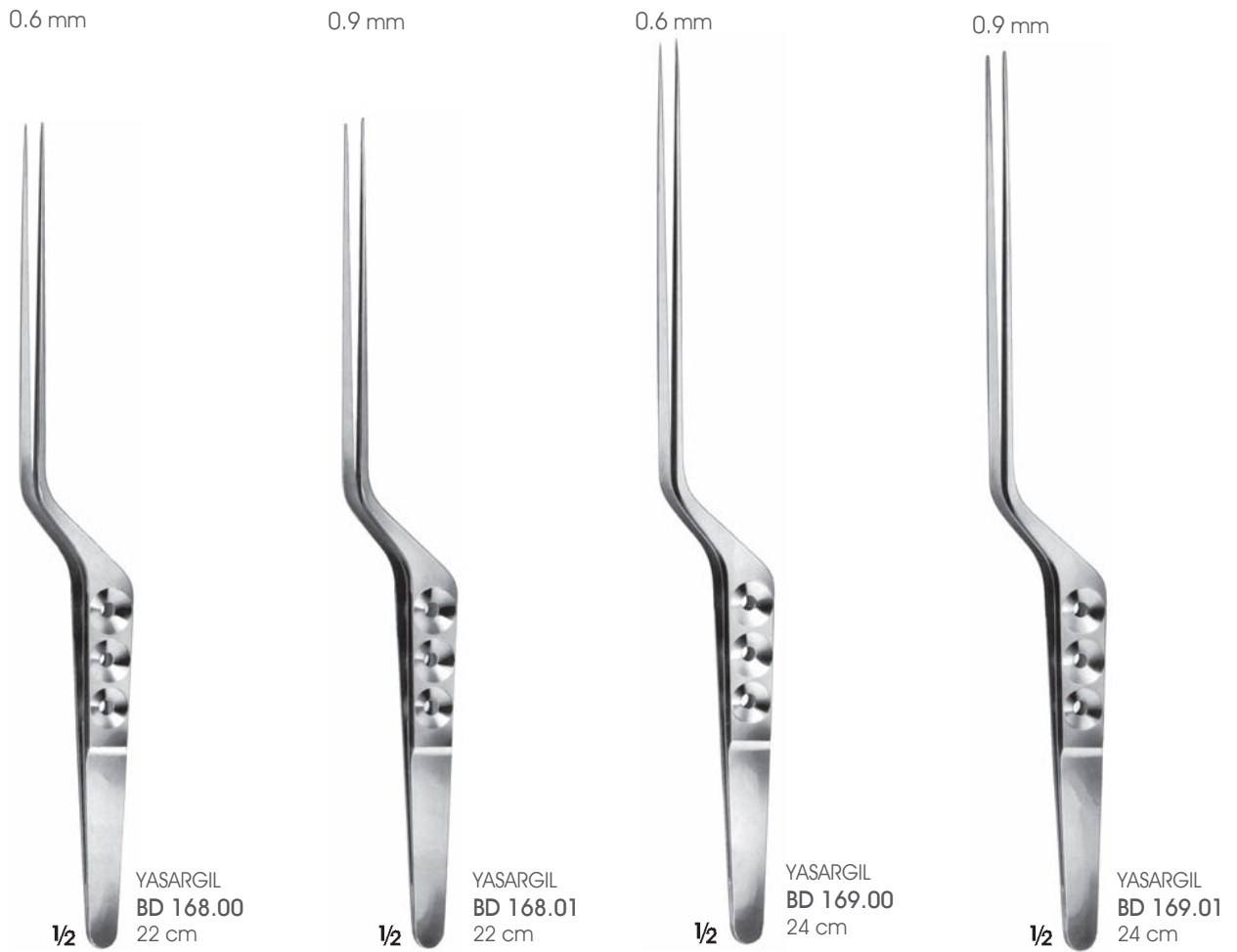

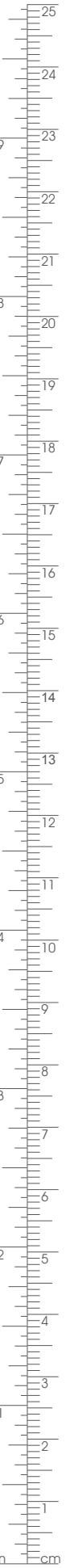
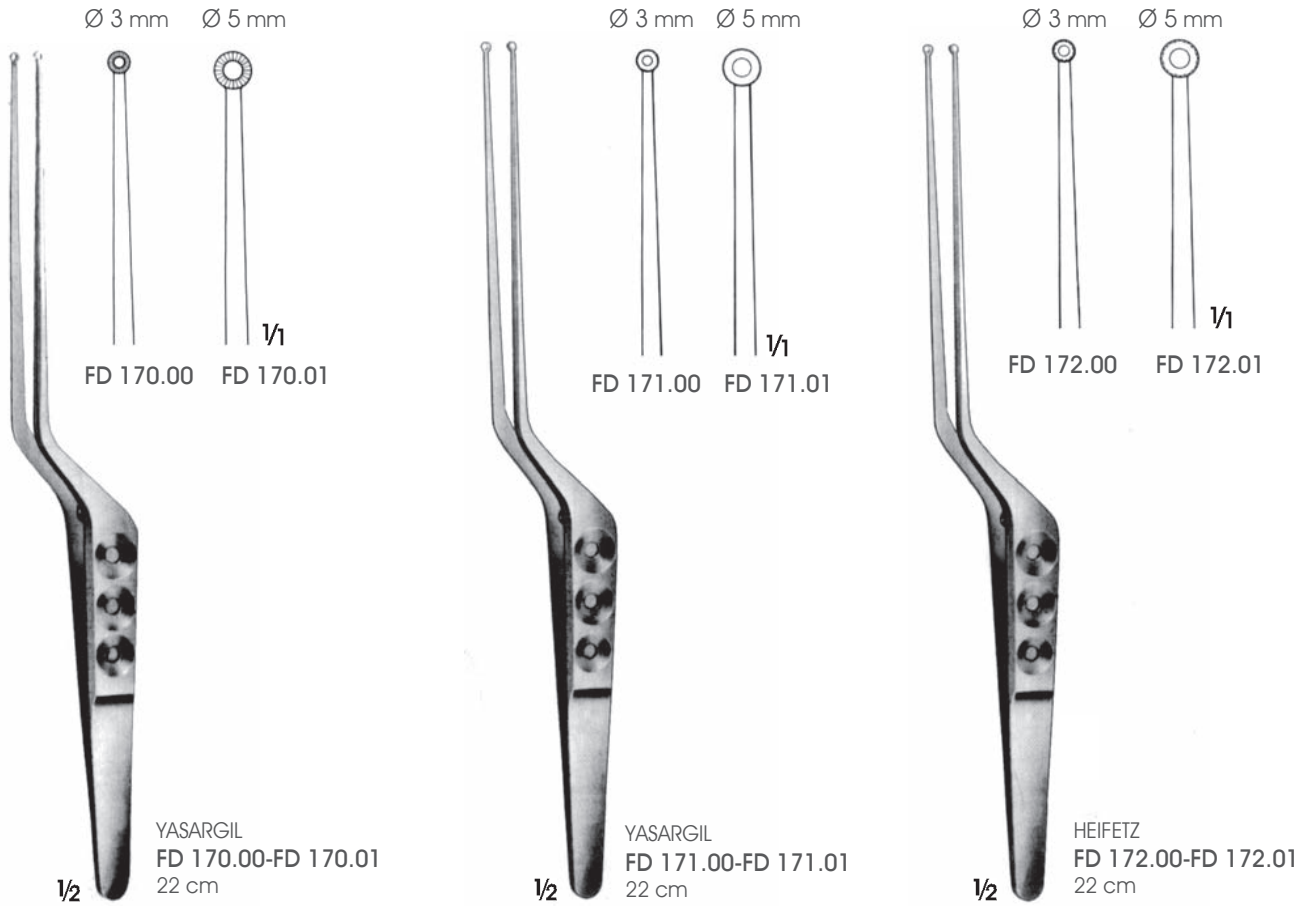
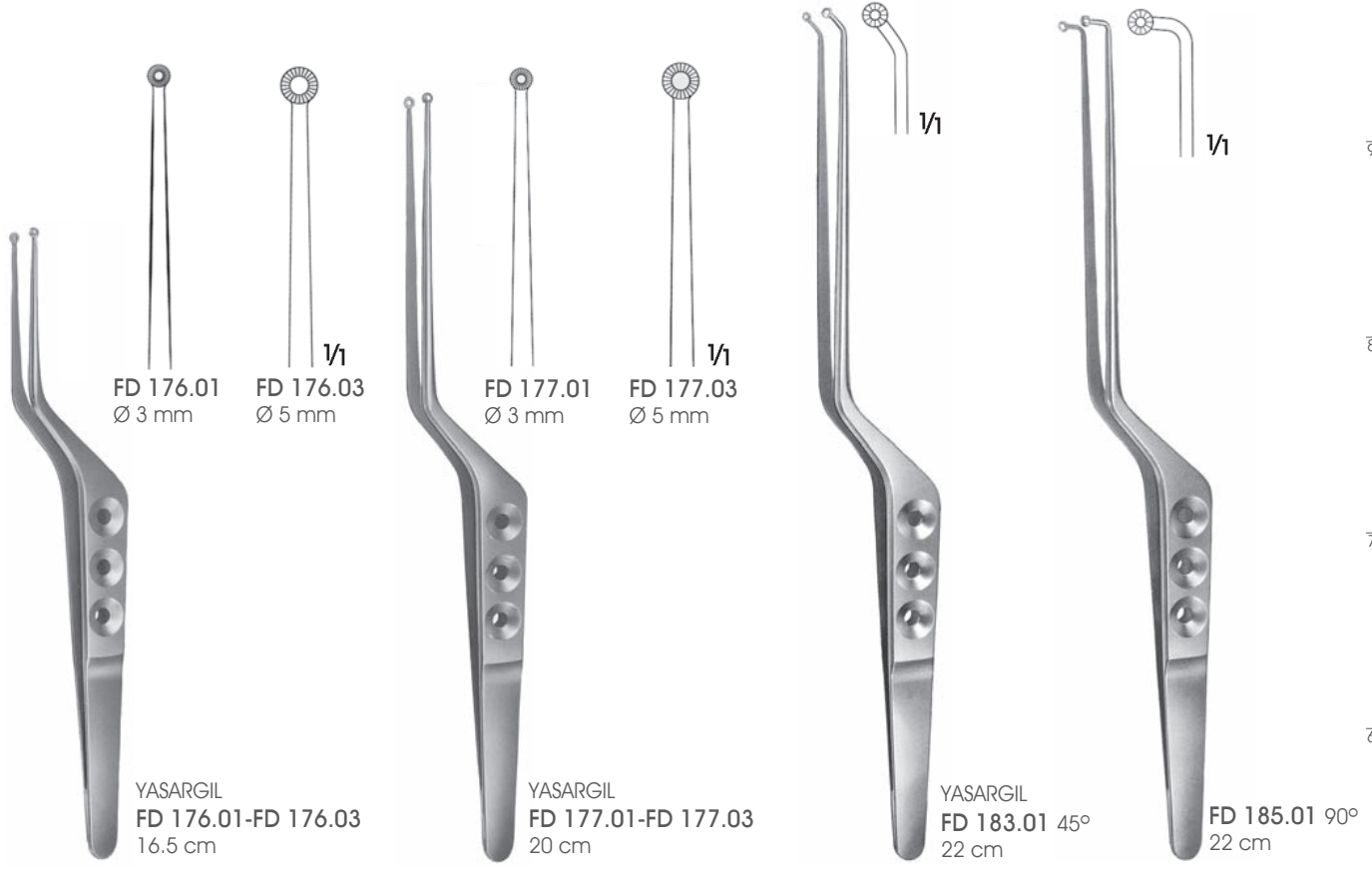

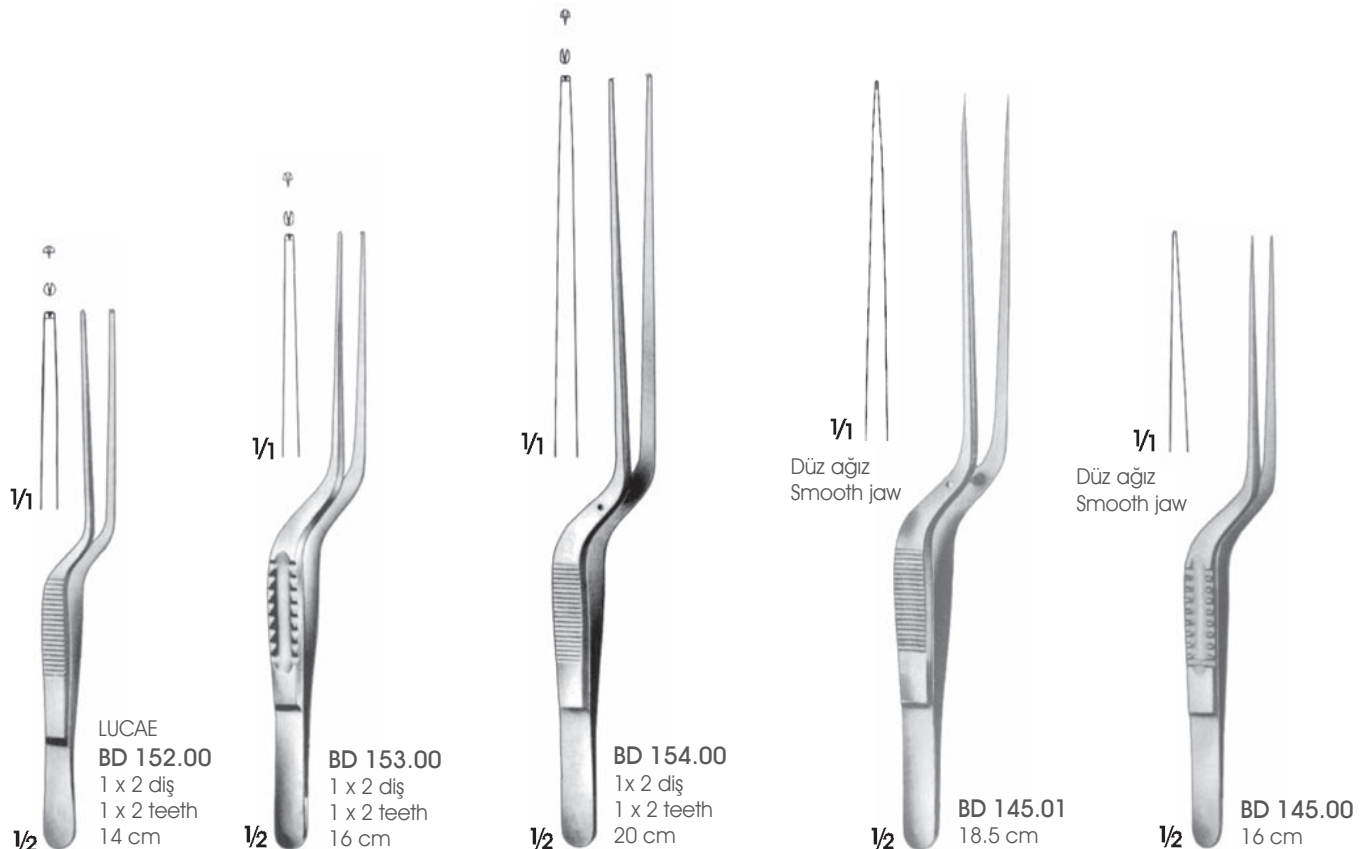
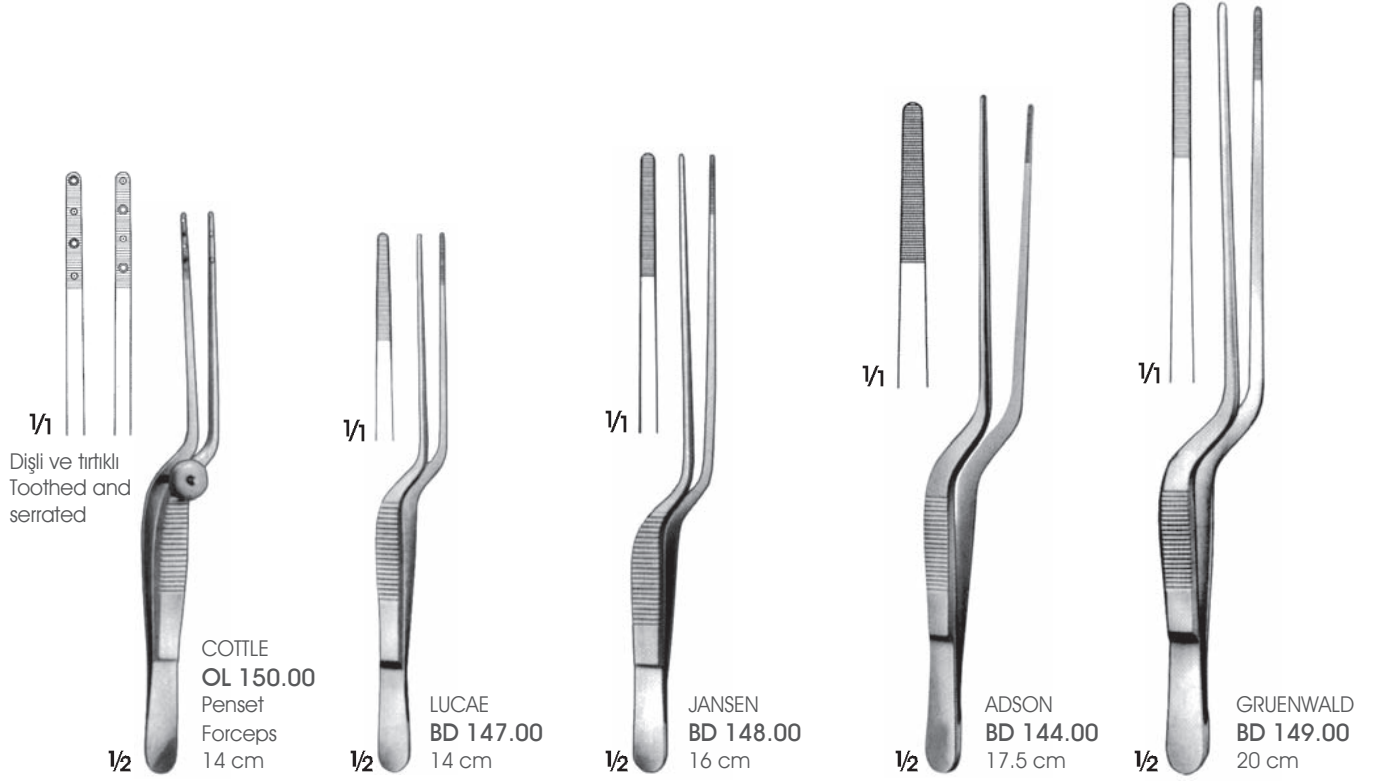

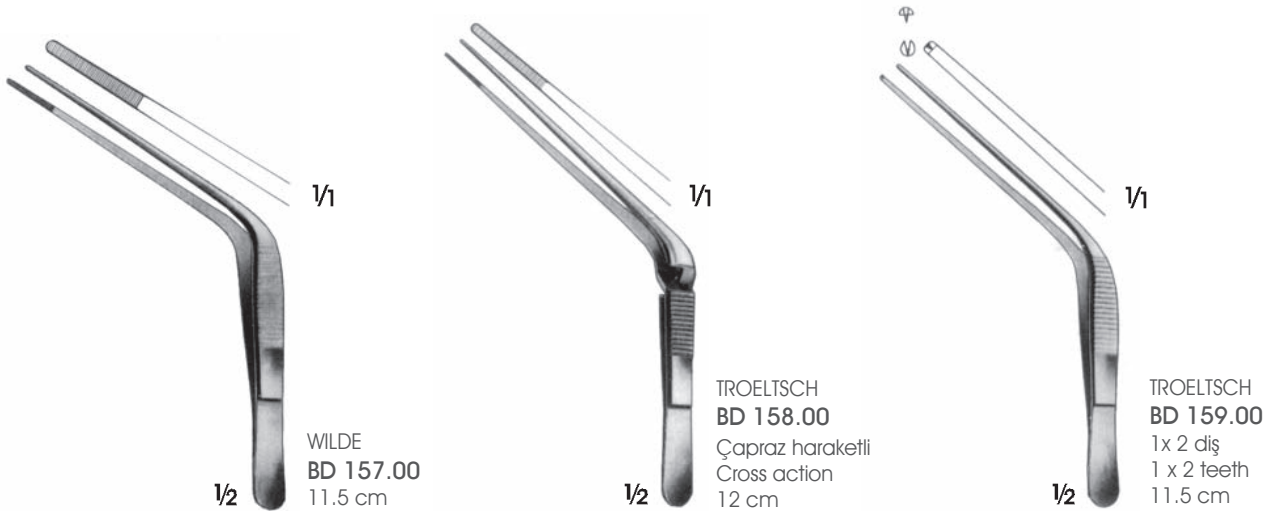
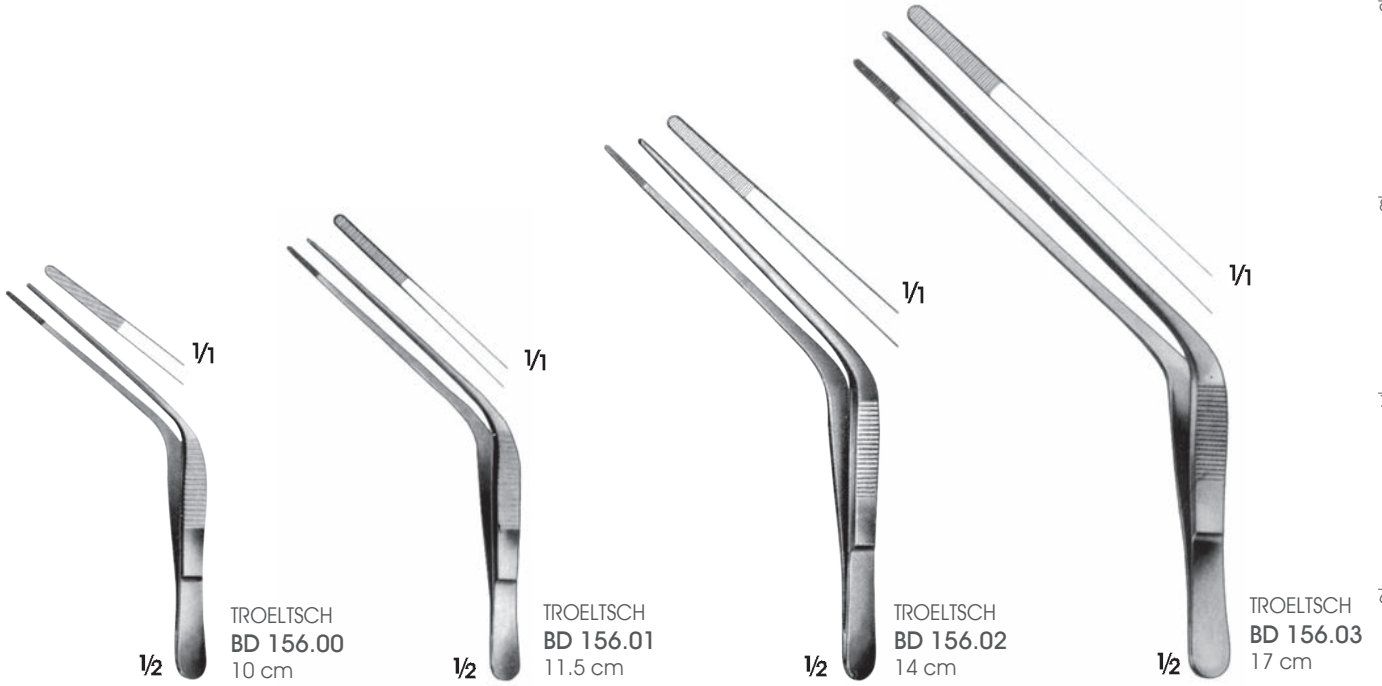

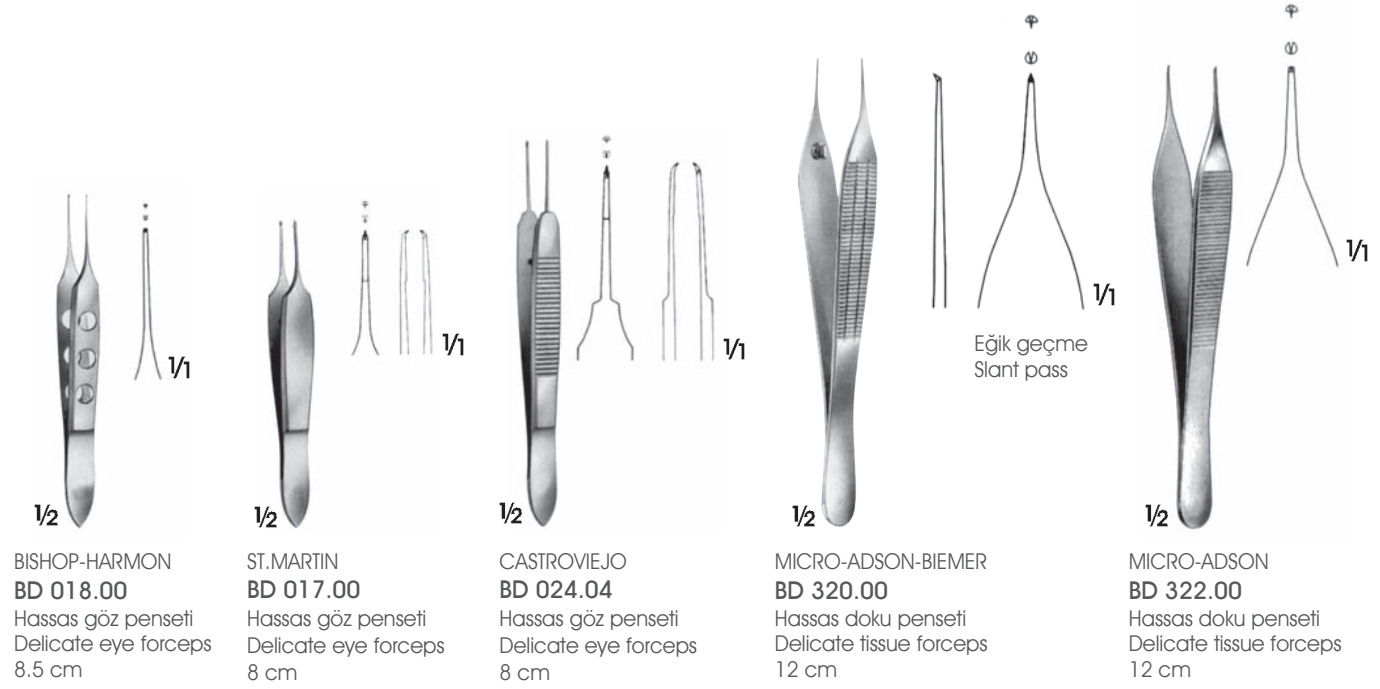

BISHOP-HARMON
BD 018.00
Hassas göz penseti
Delicate eye forceps
8.5 cm

ST.MARTIN
BD 017.00
Hassas göz penseti
Delicate eye forceps
8 cm

CASTROVIEJO
BD 024.04
Hassas göz penseti
Delicate eye forceps
8 cm

MICRO-ADSON-BIEMER
BD 320.00
Hassas doku penseti
Delicate tissue forceps
12 cm

MICRO-ADSON
BD 322.00
Hassas doku penseti
Delicate tissue forceps
12 cm

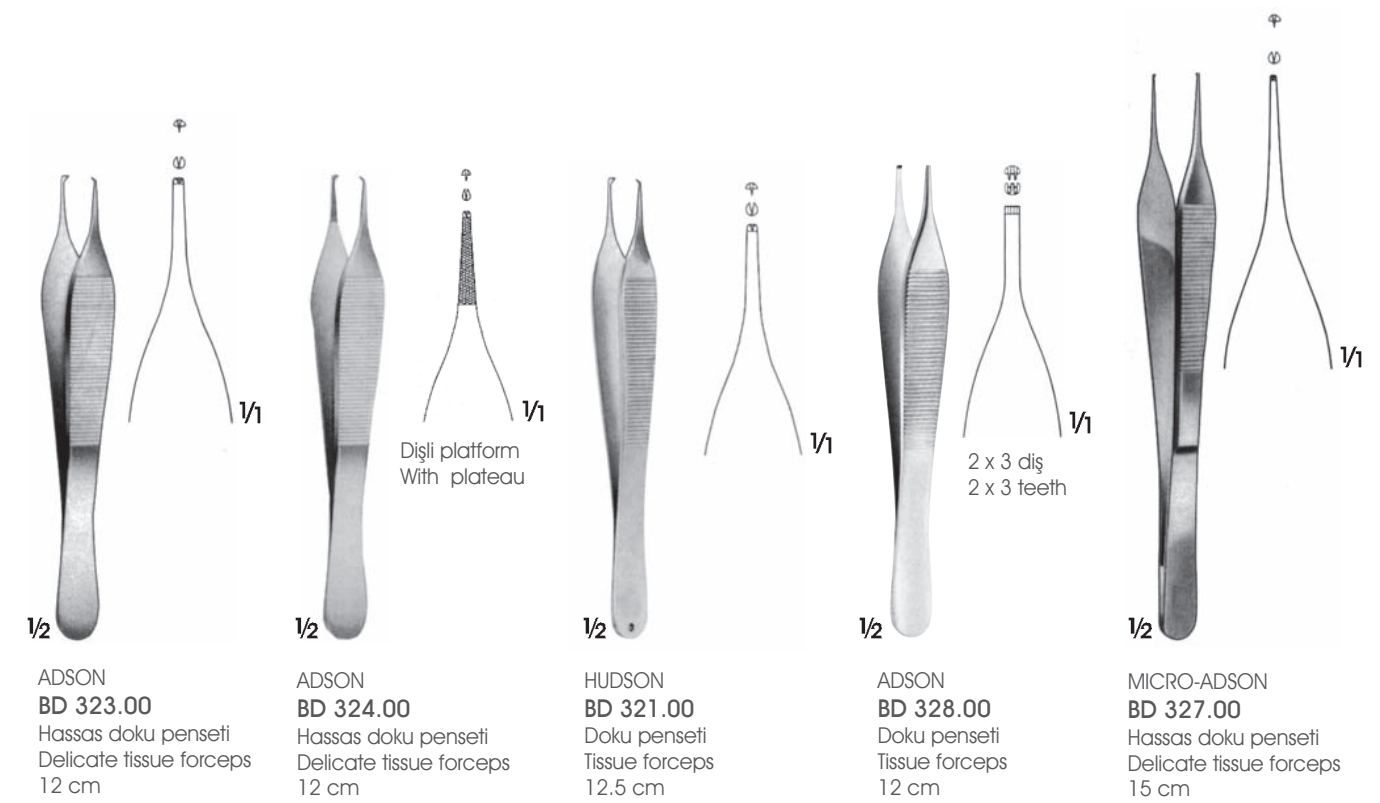

ADSON
BD 323.00
Hassas doku penseti
Delicate tissue forceps
12 cm

ADSON
BD 324.00
Hassas doku penseti
Delicate tissue forceps
12 cm

HUDSON
BD 321.00
Doku penseti
Tissue forceps
12.5 cm

ADSON
BD 328.00
Doku penseti
Tissue forceps
12 cm

MICRO-ADSON
BD 327.00
Hassas doku penseti
Delicate tissue forceps
15 cm



**ADSON
BD 325.00**
Hassas doku penseti
Delicate tissue forceps
12 cm

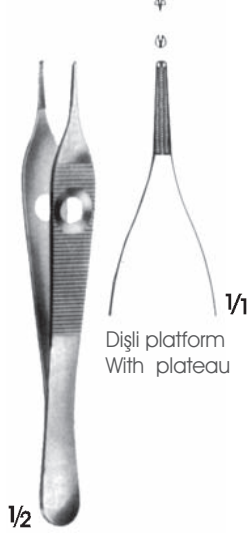

**ADSON
BD 325.01**
Hassas doku penseti
Delicate tissue forceps
12 cm



**ADSON
BD 326.00**
Hassas doku penseti
Delicate tissue forceps
12 cm



**ADSON
BD 326.01**
Hassas doku penseti
Delicate tissue forceps
12 cm

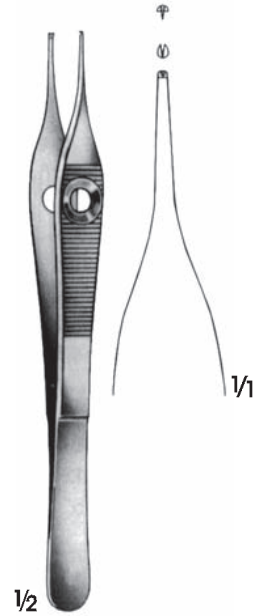

**ADSON
BD 329.00**
Hassas doku penseti
Delicate tissue forceps
15 cm

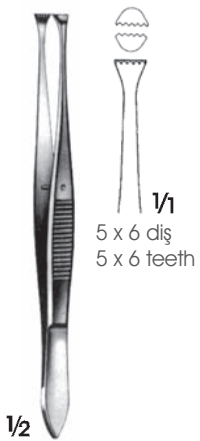

**GRAEFE
OC 351.00**
Dişli doku penseti
Tissue forceps
11 cm



**ADSON-BROWN
BD 340.00**
Dişli doku penseti, sivri
Tissue forceps, sharp
12 cm

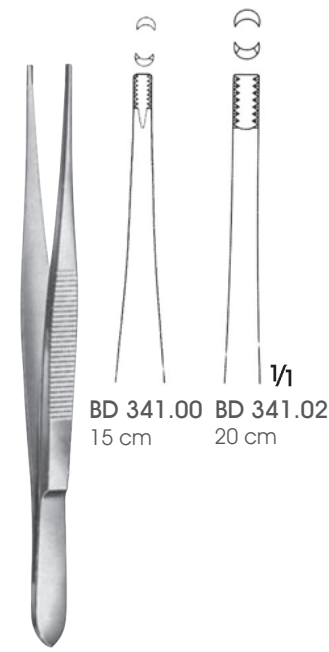

**BROWN
BD 341.00 15 cm
BD 341.02 20 cm**
Dişli doku pensetleri
Tissue forceps



**ADSON
BD 330.00**
Hassas doku penseti
Delicate tissue forceps
18 cm



**JEFFERSON
BD 331.00**
Hassas doku penseti
Delicate tissue forceps
18 cm



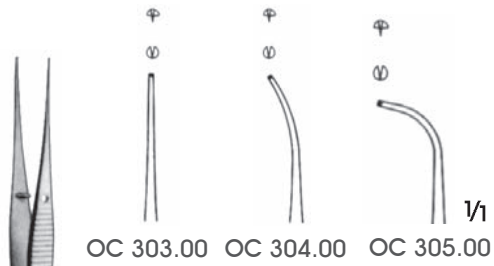

1/2
OC 303.00 -
OC 305.00
10 cm



1/2
BD 306.00
10 cm



1/2
BD 306.01
11 cm

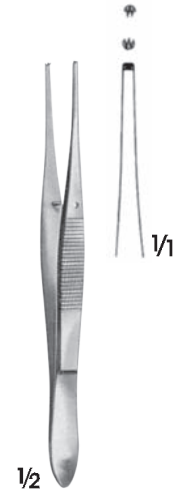

1/2
BD 308.00
2 x 3 dişli
2 x 3 teeth

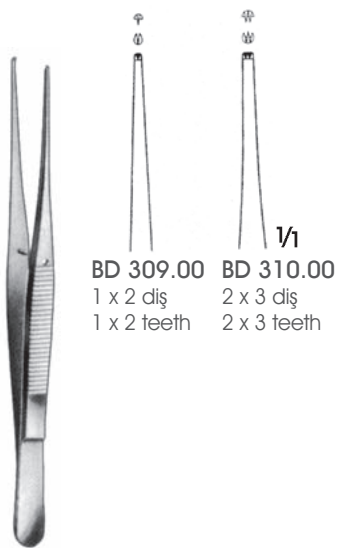

1/2
SEMKEN
BD 309.00-BD 310.00
12.5 cm

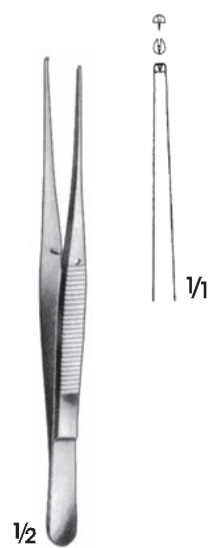

1/2
SEMKEN
BD 309.01
15 cm

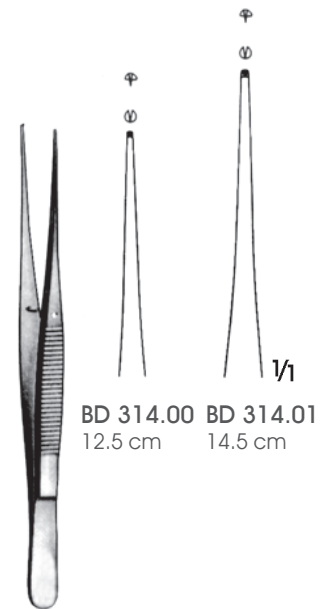

SEMKEN
BD 314.00-BD 314.01

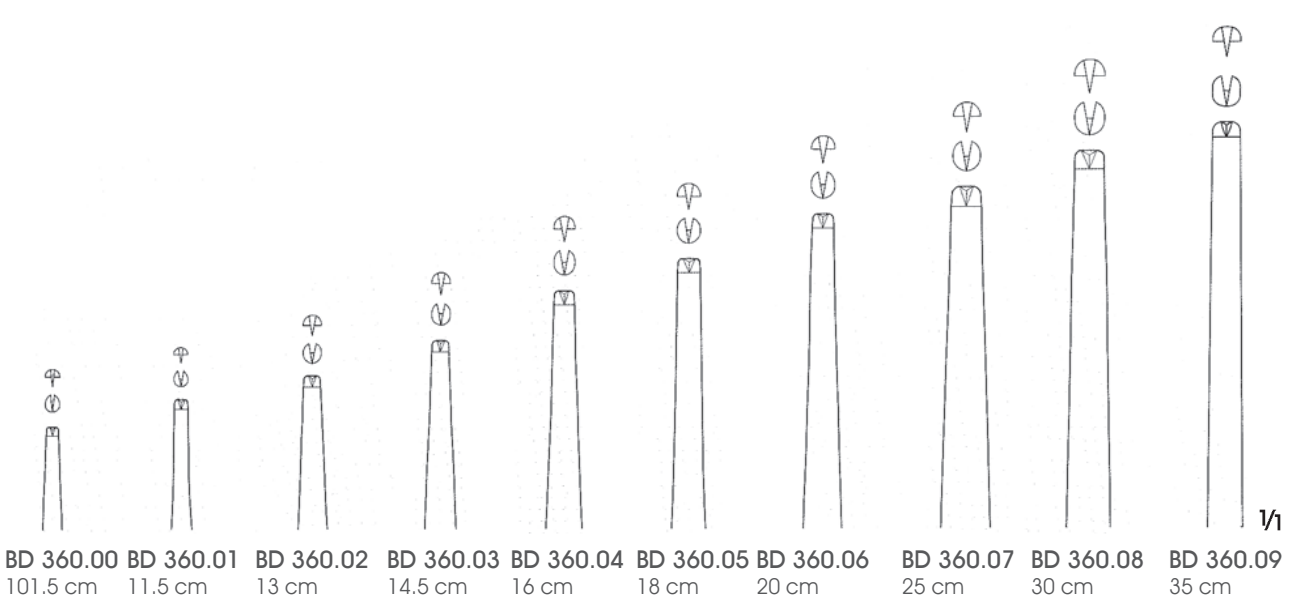

BD 360.00 101.5 cm BD 360.01 11.5 cm BD 360.02 13 cm BD 360.03 14.5 cm BD 360.04 16 cm BD 360.05 18 cm BD 360.06 20 cm BD 360.07 25 cm BD 360.08 30 cm BD 360.09 35 cm

BD 360.00-BD 360.09
Satandard model
Standard modelle

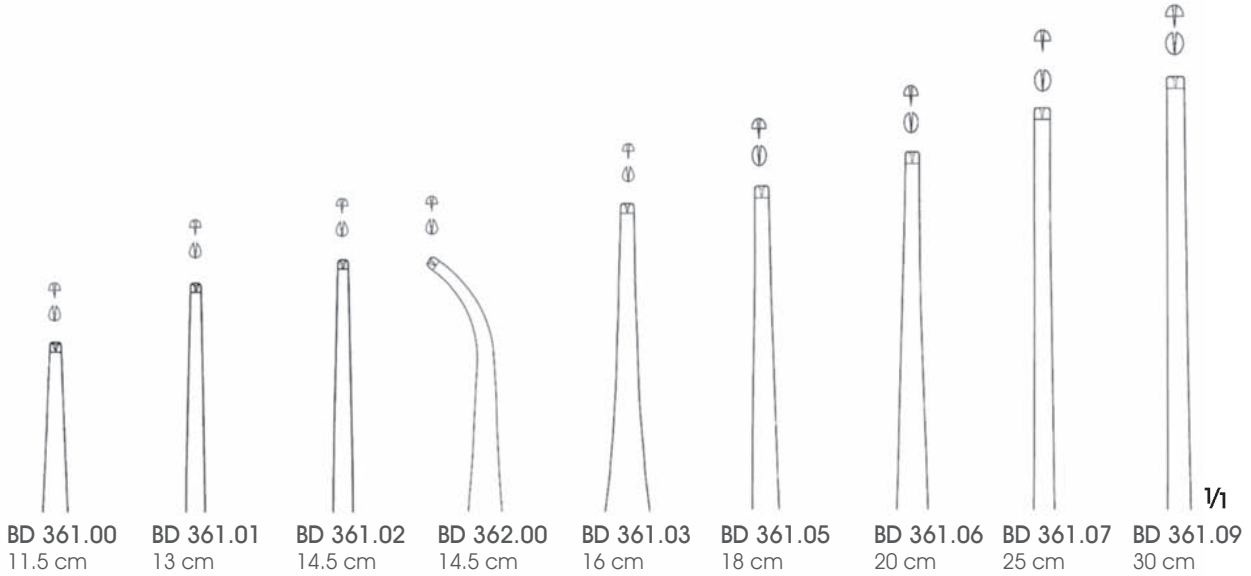

BD 361.00 11.5 cm BD 361.01 13 cm BD 361.02 14.5 cm BD 362.00 14.5 cm BD 361.03 16 cm BD 361.05 18 cm BD 361.06 20 cm BD 361.07 25 cm BD 361.09 30 cm

BD 361.00-BD 362.00
Orta boy/medium

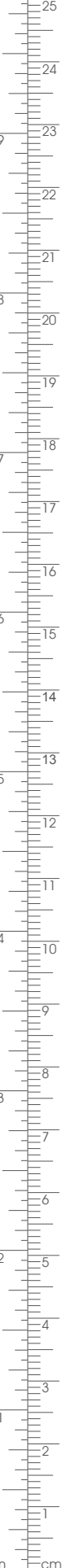

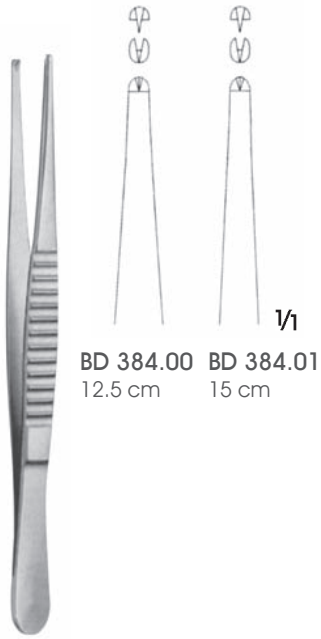

BD 384.00 12.5 cm
BD 384.01 15 cm

TREVES
BD 384.00-BD 384.01
Doku pensetleri Tissue forceps

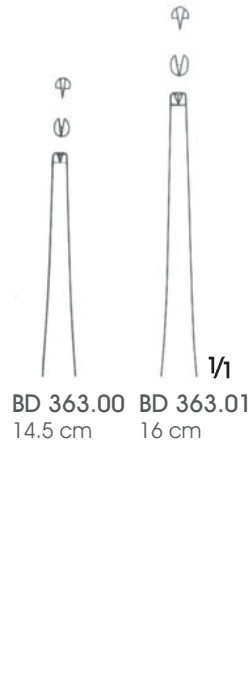

BD 363.00 14.5 cm
BD 363.01 16 cm

BD 363.00
BD 363.01
Doku pensetleri Tissue forceps

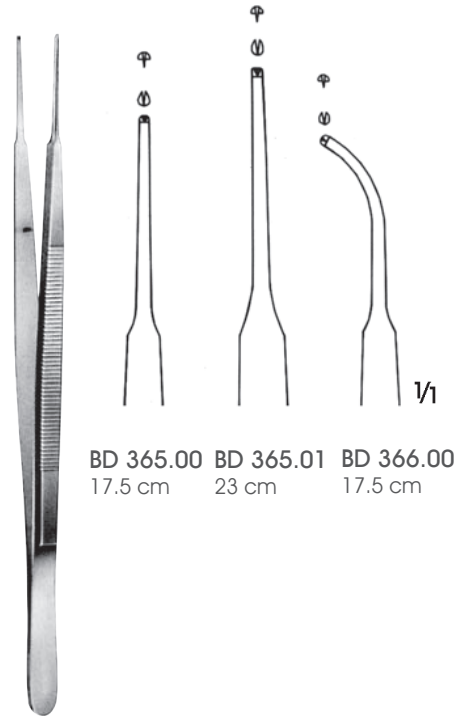

BD 365.00 17.5 cm
BD 365.01 23 cm
BD 366.00 17.5 cm

GERALD
BD365.00- BD366.00
Hassas doku pensetleri
Delicate tissue forceps



BD 368.00
Doku penset
Tissue forceps
20 cm

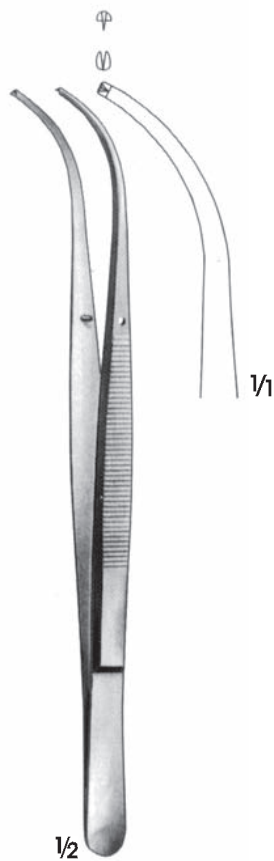

BROPHY
BD 369.00
Doku penset
Tissue forceps
20 cm



CUSHING
BD 367.00
Doku penset
Tissue forceps
18 cm

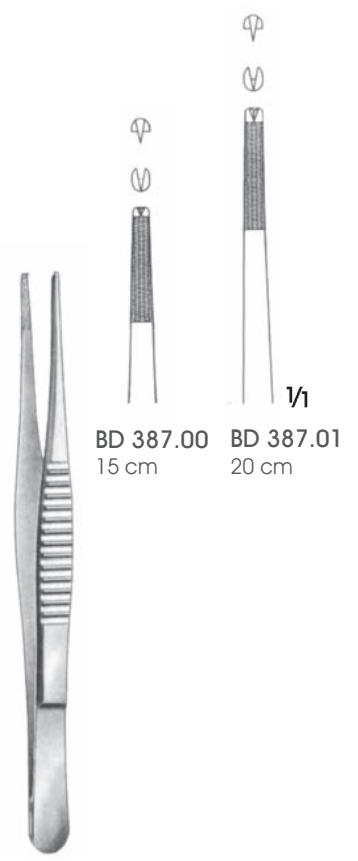

BD 387.00 15 cm
BD 387.01 20 cm

STRASSBURGER MODEL
BD 387.00-BD 387.01
Doku pensetleri Tissue forceps

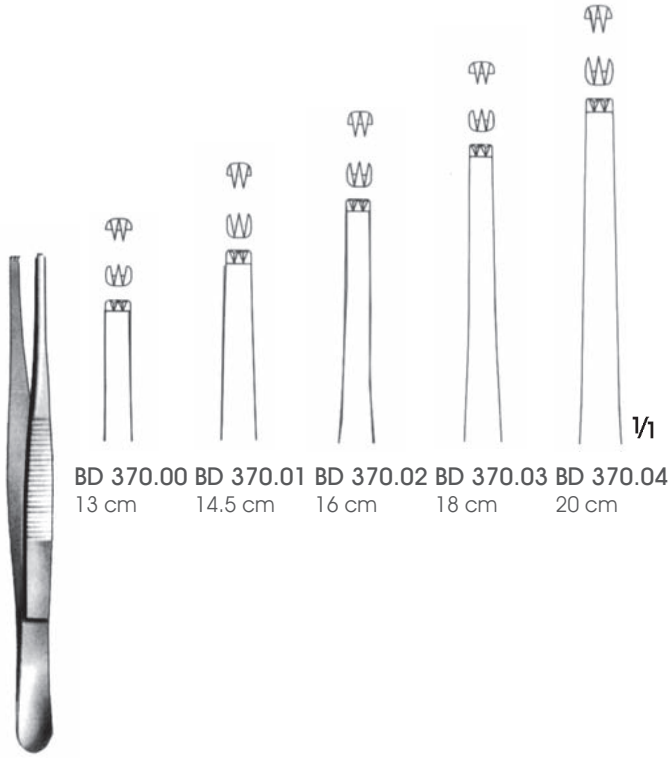

BD 370.00 13 cm
BD 370.01 14.5 cm
BD 370.02 16 cm
BD 370.03 18 cm
BD 370.04 20 cm

BD 370.00-BD 370.04
2 x 3 diş/2 x 3 teeth

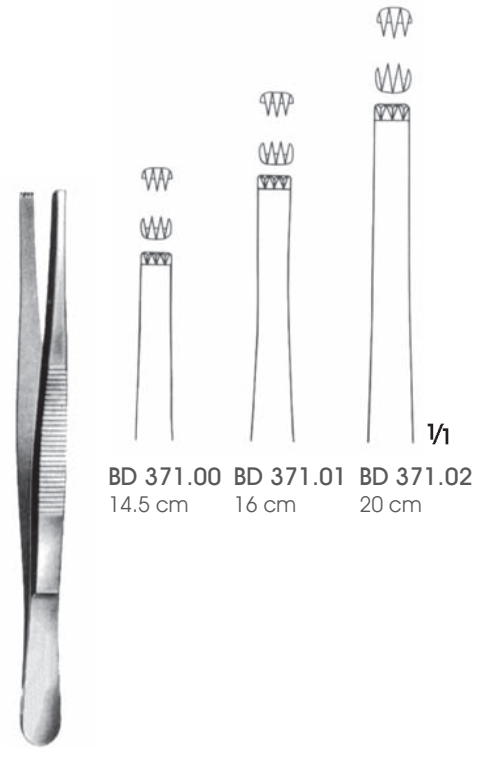

BD 371.00 14.5 cm
BD 371.01 16 cm
BD 371.02 20 cm

BD 371.00-BD 371.02 3 x 4
diş/3 x 4 teeth



4 x 5 dişli
4 x 5 teeth

BD 373.00
14.5 cm



BD 364.00
Güçlü model/Heavy Pattern
14.5 cm

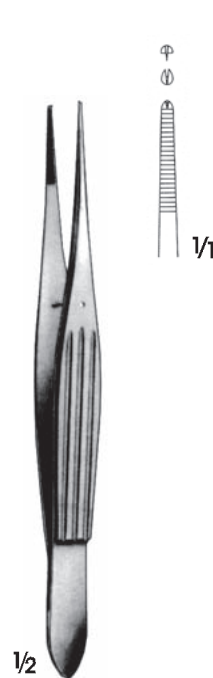

MC INDOE
BD 380.00
15 cm

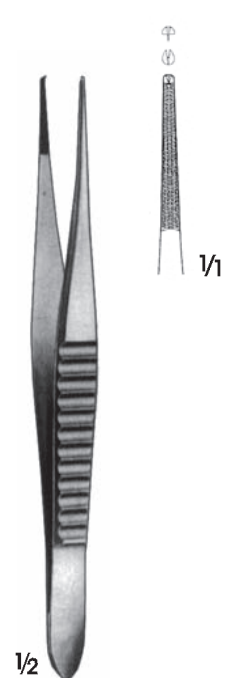

GILLIES
BD 381.00
15.5 cm



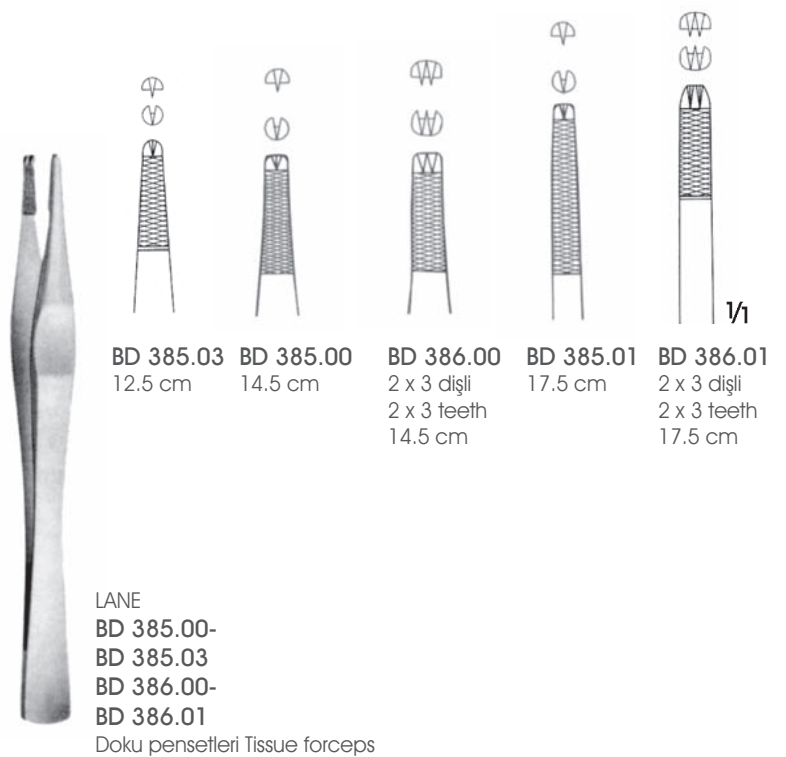
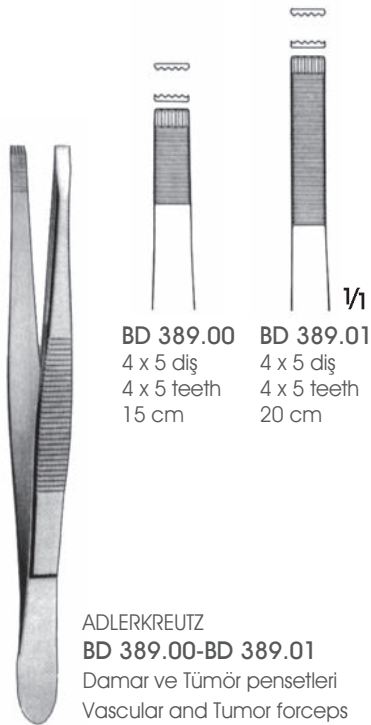
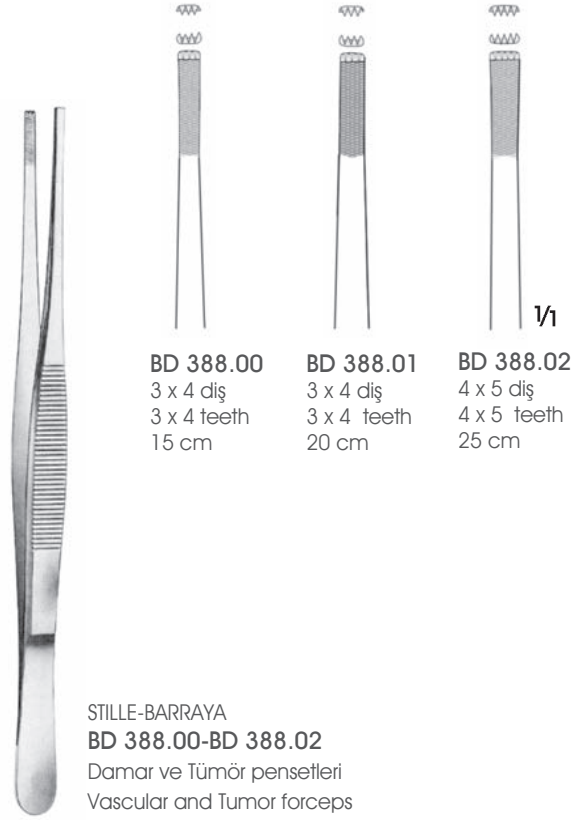
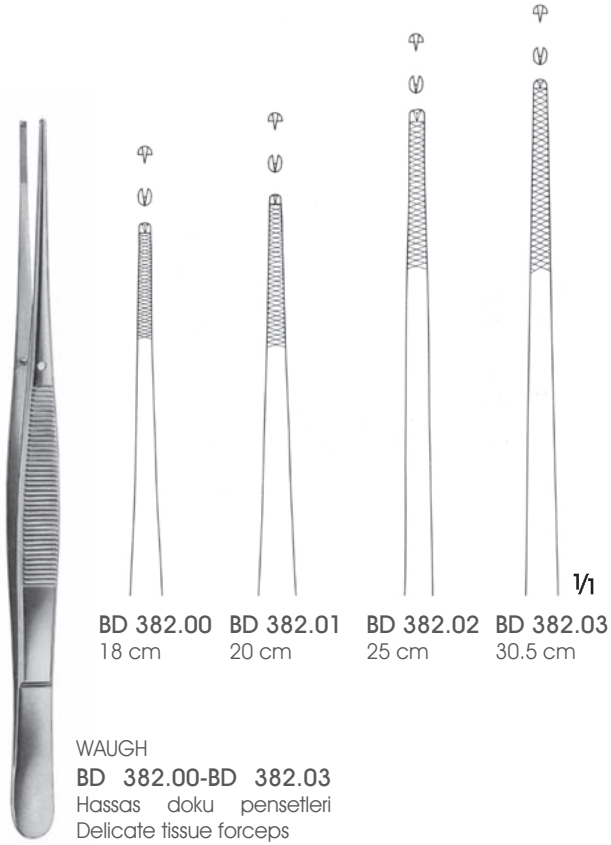

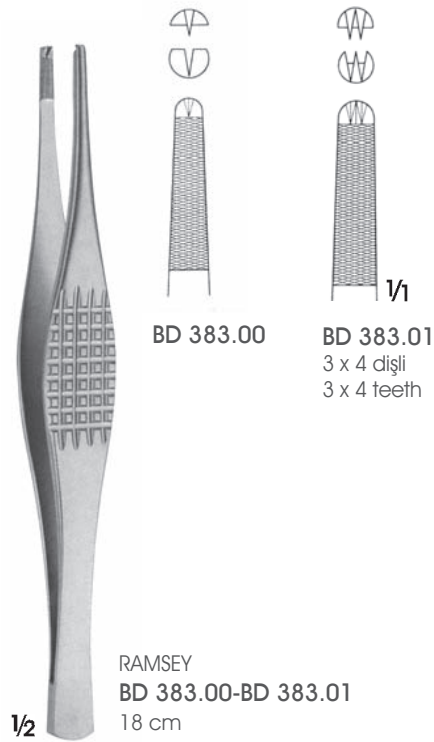
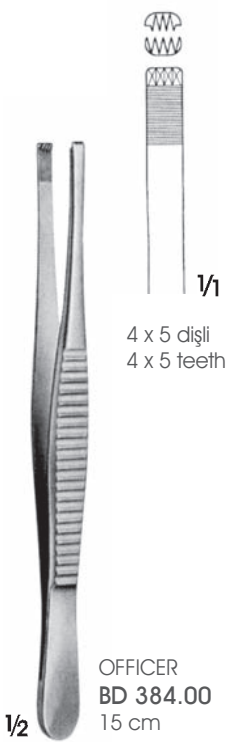
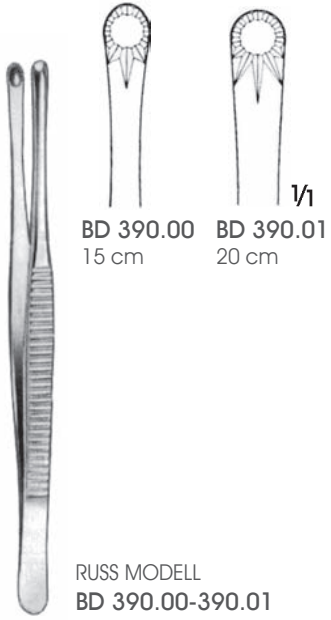

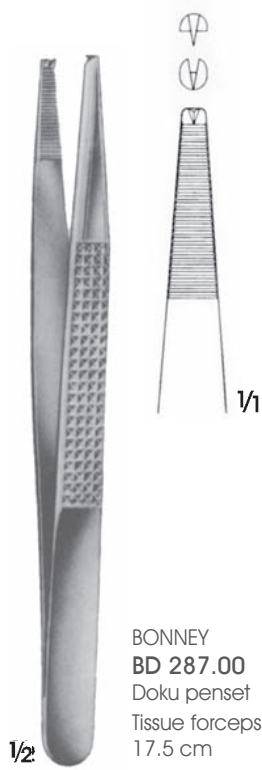

BONNEY
BD 287.00
 Doku penset
 Tissue forceps
 17.5 cm



CHARNLEY
BD 374.00
 Doku penset
 Tissue forceps
 18 cm

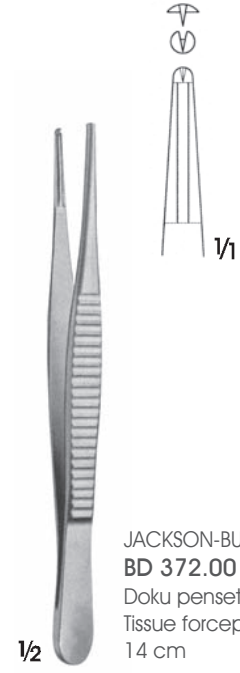

JACKSON-BURROWS
BD 372.00
 Doku penset
 Tissue forceps
 14 cm

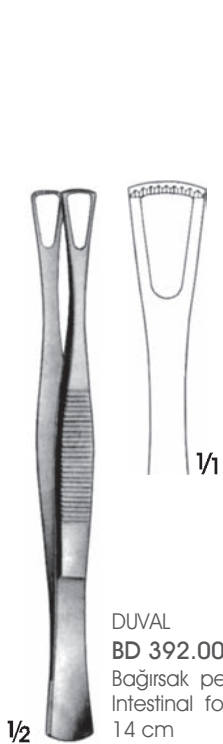

DUVAL
BD 392.00
 Bağırsak penset
 Intestinal forceps
 14 cm

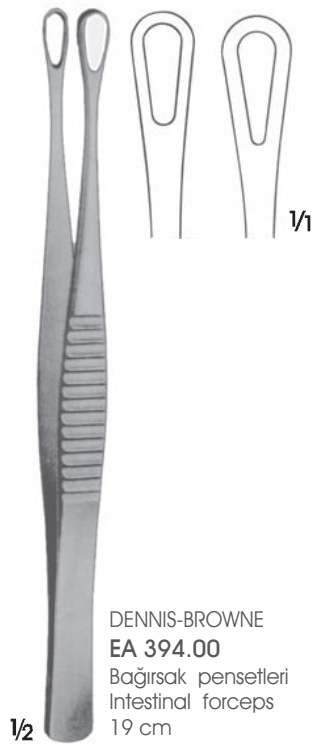

DENNIS-BROWNE
EA 394.00
 Bağırsak pensetleri
 Intestinal forceps
 19 cm

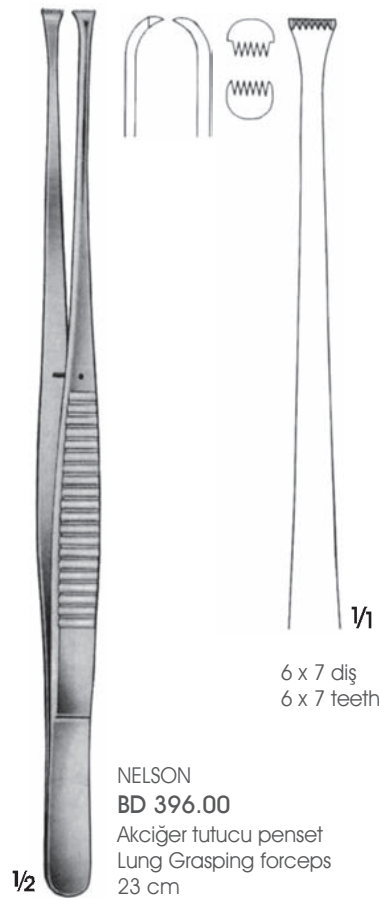

NELSON
BD 396.00
 Akciğer tutucu penset
 Lung Grasping forceps
 23 cm

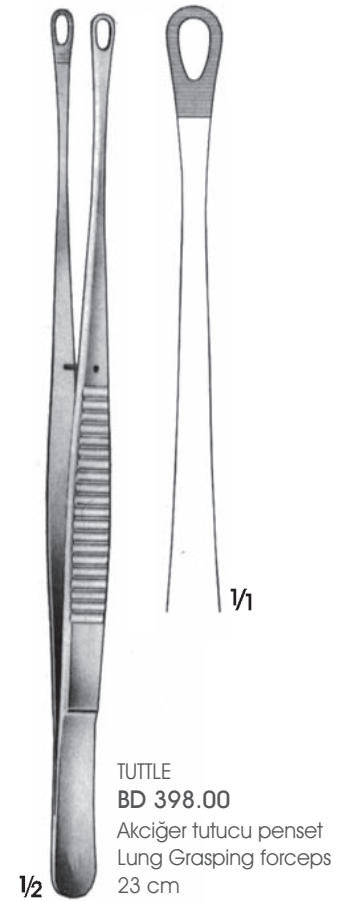

TUTTLE
BD 398.00
 Akciğer tutucu penset
 Lung Grasping forceps
 23 cm



BD 410.00
Kıymık penset
Splinter forceps
8 cm

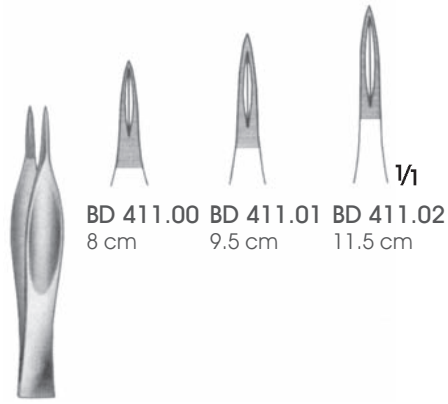

FEILCHENFELD
BD 411.00 -BD 411.02
Kıymık pensetler Splinter
forceps

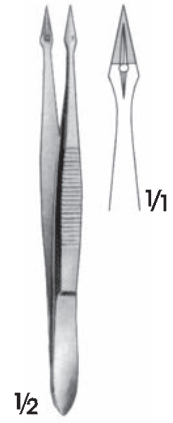

HUNTER
BD 412.00
Kıymık penset
Splinter forceps
10.5 cm

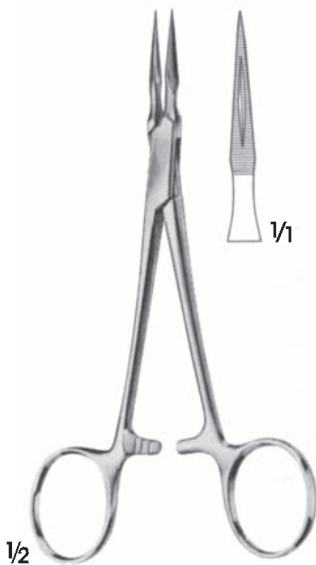

STIEGLITZ
BD 420.00
Kıymık penset
Splinter forceps
14 cm



STIEGLITZ
BD 421.00
Kıymık penset
Splinter forceps
14 cm

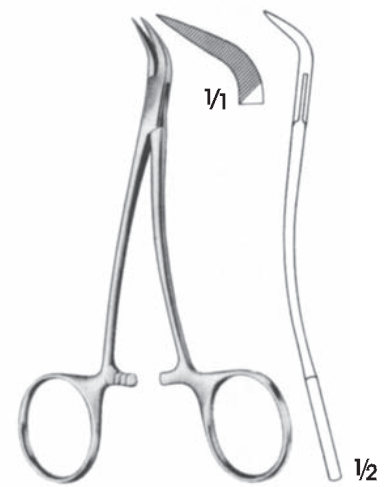

STIEGLITZ
BD 422.00
Kıymık penset
Splinter forceps
12 cm

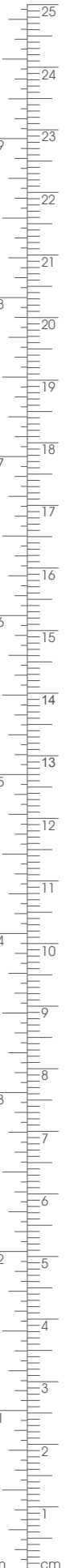

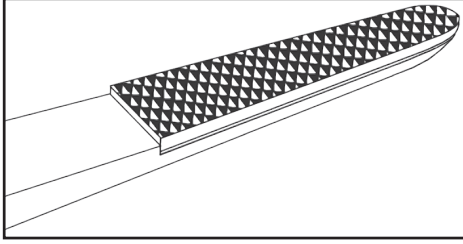

Karbid uclu Diseksiyon Pensleri

- Ince yapılı karbid ucu sayesinde verimli kullanım...
- Sıkı şekilde ve dokuya zarar vermeden kavrama...
- Çok amaçlı kullanım
- Uzun çalışma süresi

Carbide-tipped dissecting forceps

- Due-to slender carbide tip, efficient use
- Tight gripping without damaging the tissue
- Multi-purpose use
- Long working life

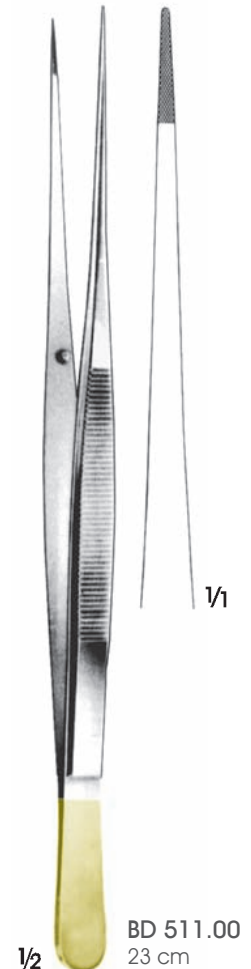
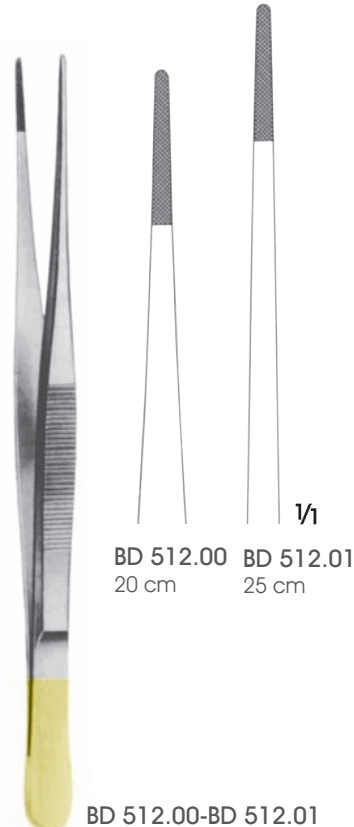
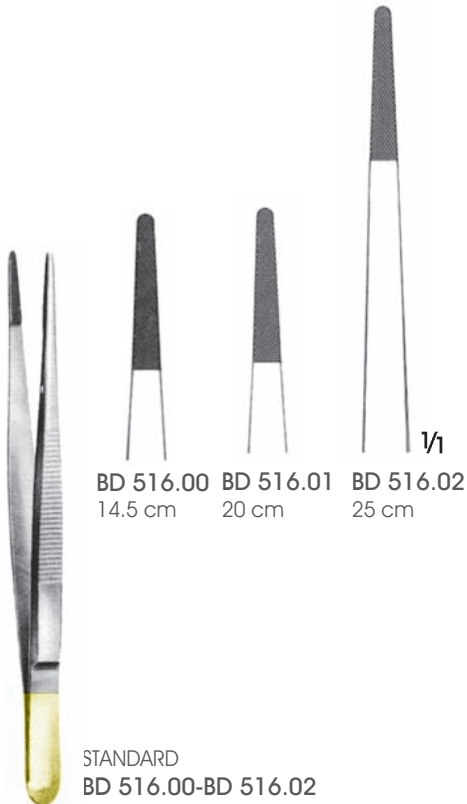
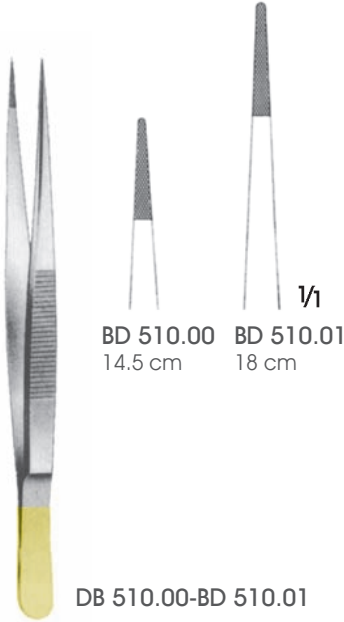



WANGENSTEEN
BD 520.00-BD 520.01
 Diseksiyon pensetler
 Dissecting forceps

BD 520.00 15 cm
BD 520.01 23 cm



FERRIS-SMITH
BD 523.00
 Diseksiyon pensetler
 Dissecting forceps

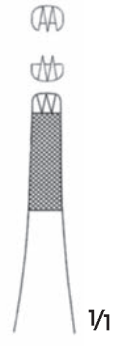

BD 519.00
 Sutür penseti/Suture forceps
 20 cm

Yastık şekilli ucu ile güvenli
 nazık bir kavrama sağlar
 Cushion shaped tip
 ensures a safe and
 gentle grasping of the thread



CUSHING
BD 513.00-BD 514.00
 Arka kısmı spatula model
 With scraper end

BD 513.00 18 cm
BD 514.00 21 cm

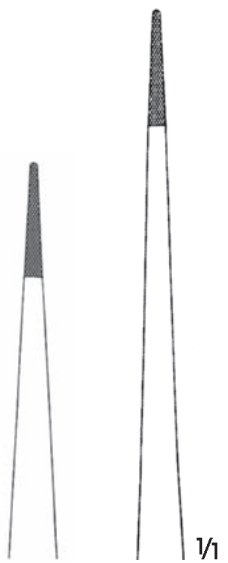

BD 517.00 14 cm
BD 517.01 16 cm
 Diseksiyon pensetler
 Dissecting forceps

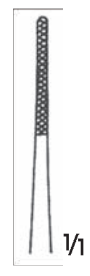

GRUENWALD
BD 518.00
 Diseksiyon pensetler
 Dissecting forceps

18.5 cm

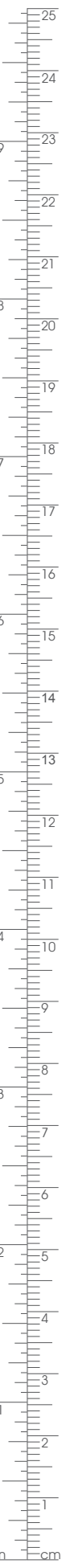

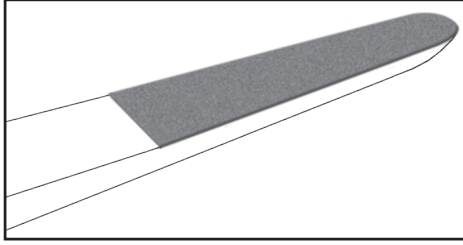

DIAMOTE ağızlar, daha sert ve aşınmaya dayankılı yüzeyler sağlar.
DIAMOTE ağızlar, hassas iğne, suture ve dokuların güvenilir bir şekilde kavranmasını garanti eder.

DIAMOTE jaws provide harder and more wear resistant surfaces.
DIAMOTE jaws ensure reliable grip of fine needles, sutures and tissues.

	Ø 1.0 mm	Ø 1.0 mm	Ø 1.0 mm		Ø 1.0 mm	Ø 2.0 mm	Ø 1.0 mm
	18.5 cm 21 cm	FM 601.03 FM 601.05	FM 602.03 FM 602.05	FM 604.03 FM 604.05	15 cm 18.5 cm 21 cm 23 cm 25 cm	- FM 606.13 - - -	FM 608.01 FM 608.03 FM 608.05 FM 608.06 FM 608.08
	Platform tip, düz Platform tip, straight	Düz/Straight	Eğri/Curved		Düz/Straight	Düz/Straight	Eğri/Curved
FM 601.03-FM 604.05				FM 606.01-FM 608.08			

	Ø 2.5 mm	Ø 2.5 mm		Ø 1.2 mm	Ø 1.2 mm
	FM 618.03 18 cm	FM 618.05 20 cm		FM 615.01 18 cm	FM 615.03 22 cm
FM 618.03-FM 618.05			FM 615.01-FM 615.03		



18.5 cm **FM 630.02**
21 cm **FM 630.04**
Platform tip, düz
Platform tip, straight

FM 630.02-FM 630.04
Yuvarlak sap/Round handle



1/1



15 cm **FM 633.01**
18.5 cm **FM 633.03**
21 cm **FM 633.05**
25 cm **FM 633.08**
Platform tip, düz
Platform tip, straight

FM 635.01
FM 635.03
FM 635.05
FM 635.08
Platform tip, eğri
Platform tip, curved

FM 633.01-FM 635.08
Yuvarlak sap/Round handle



1/1



1/1



Platformlu
With plateau

WACHTEL
FM 637.00
Micro diseksiyon
penset, yuvarlak sap
Micro dissecting forceps,
round handle
18 cm

1/2



FM 660.03
Ø 1.0 mm
Düz/Straight

FM 661.03
Ø 1.0 mm
Eğri/Curved

FM 660.01-FM 661.01
Düz sap/Flat handle 18
cm



1/1



18 cm **FM 665.03**
20 cm **FM 665.05**
1.0 mm
Düz/Straight

FM 665.03-FM 665.05
Düz sap/Flat handle



1/1



FM 673.00
1 mm
1 x 2 diş
1 x 2 teeth

FM 673.10
1 mm
1 x 2 diş
1 x 2 teeth

FM 673.00-FM 673.10
Dişli doku pensetleri, düz
sap
Mikro tissue forceps flat
handle
18 cm



1/1



FM 675.00
Düz
1 x 2 diş
Straight
1 x 2 teeth

FM 675.10
Eğri
1 x 2 diş
Curved
1 x 2 teeth

WACHTEL
FM 675.00-FM 675.10
Mikro dişli doku pensetleri
yuvarlak sap
Mikro tissue forceps round
handle
18 cm

1/2



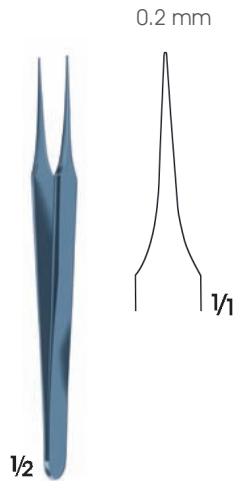

BD 103.00T
Mikro penset, kuyumcu tipi
Micro forceps, jeweler patterns
11 cm

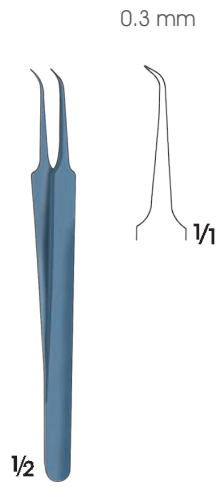

BD 104.00T
Mikro penset, kuyumcu tipi
Micro forceps, jeweler patterns
11 cm

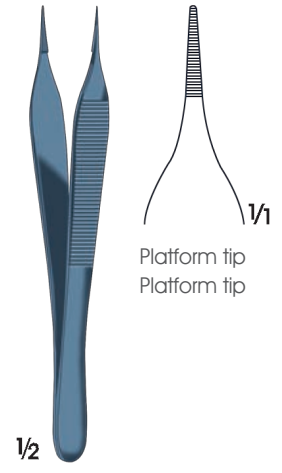

MICRO-ADSON
BD 204.00T
Hassas diseksiyon penset
Delicate dissecting forceps
12 cm



FM 609.01T 18.5 cm
FM 609.03T 21 cm
FM 609.05T 23 cm
Platformlu tip, düz
Platform tip, straight



FM 610.01T 18.5 cm
FM 610.03T 21 cm
FM 610.05T 23 cm
Düz, straight

De Bakey Diş



Toothing De Bakey

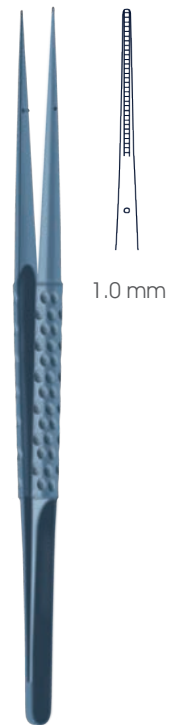

BD 257.01T 18.5 cm
BD 257.02T 21 cm
BD 257.03T 23 cm
Düz, straight

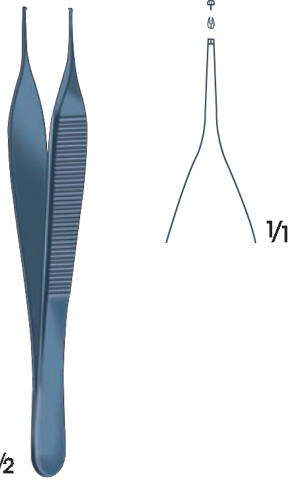

MICRO - ADSON
BD 322.00T
Hassas dişli doku penset
Delicate tissue forceps
12 cm

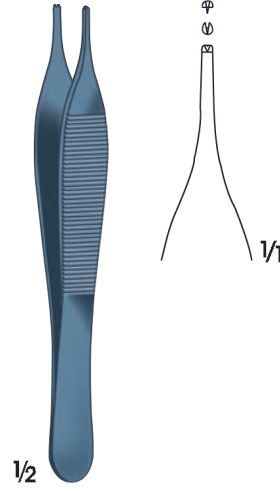

ADSON
BD 323.00T
Hassas dişli doku penset
Delicate tissue forceps
12 cm

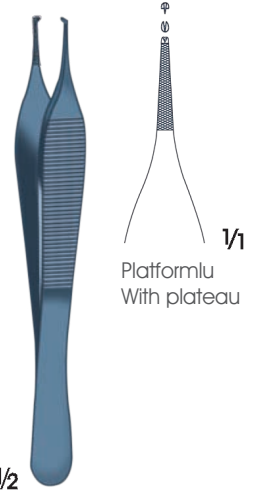

ADSON
BD 324.00T
Hassas dişli doku penset
Delicate tissue forceps
12 cm

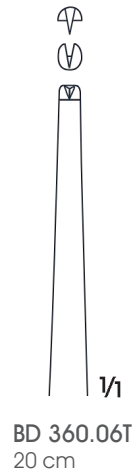
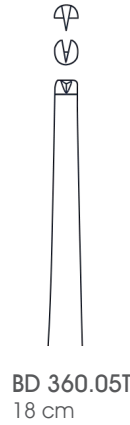
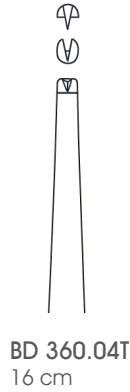
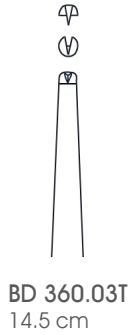
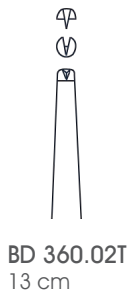

BD 360.02T-BD 360.06T
Dişli doku pensetler, standart model
Tissue forceps, standard patterns



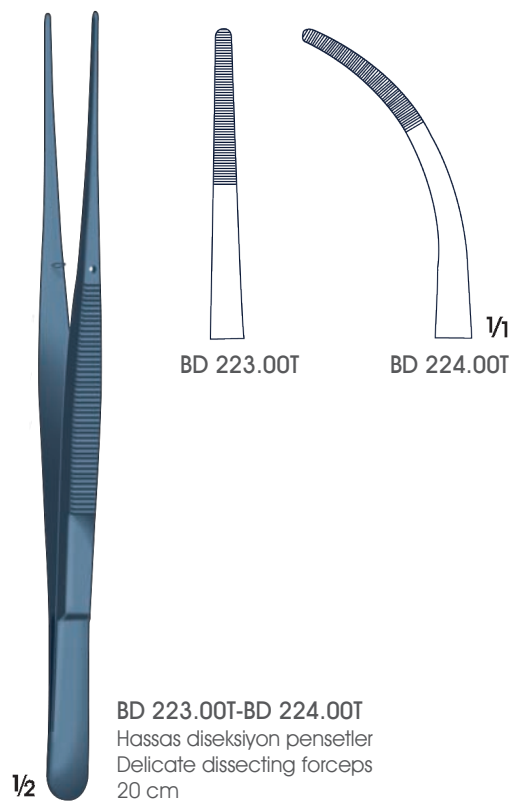
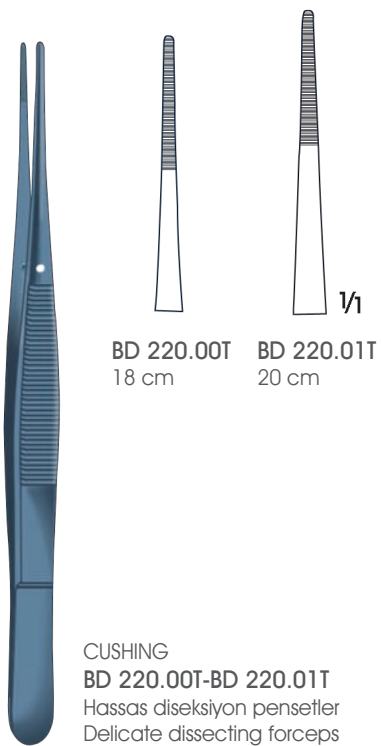
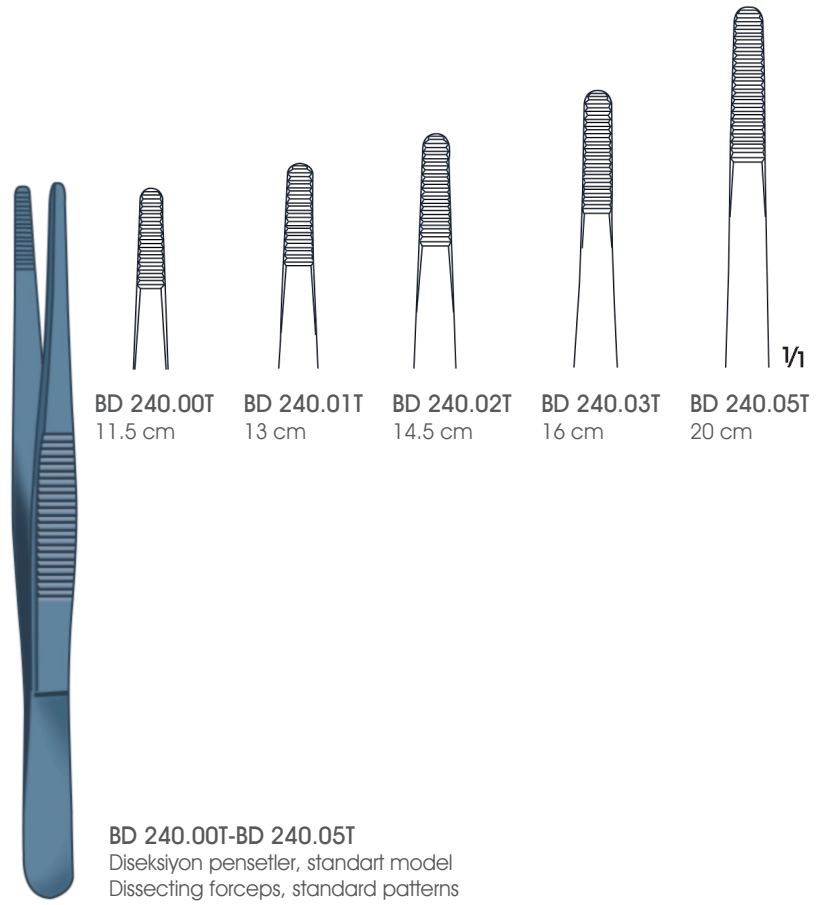
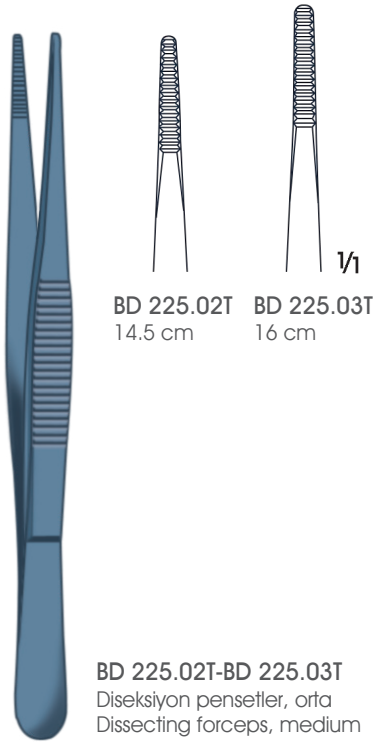

De Bakey Diş



Toothing De Bakey

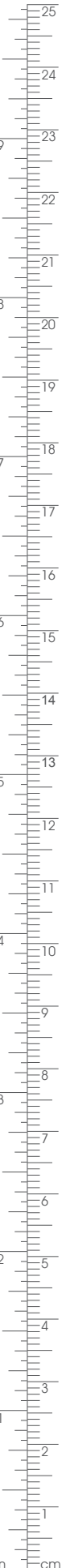
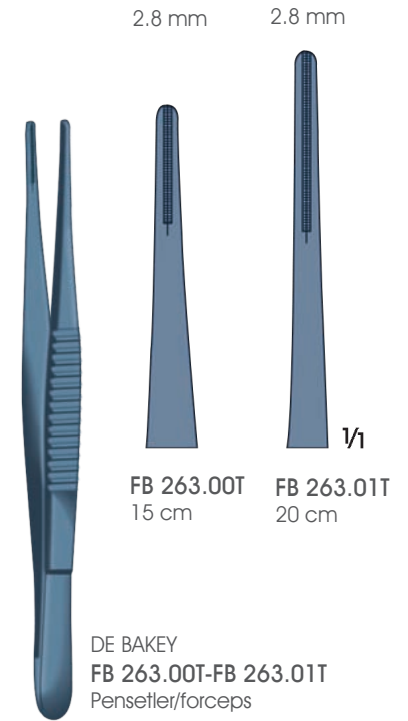
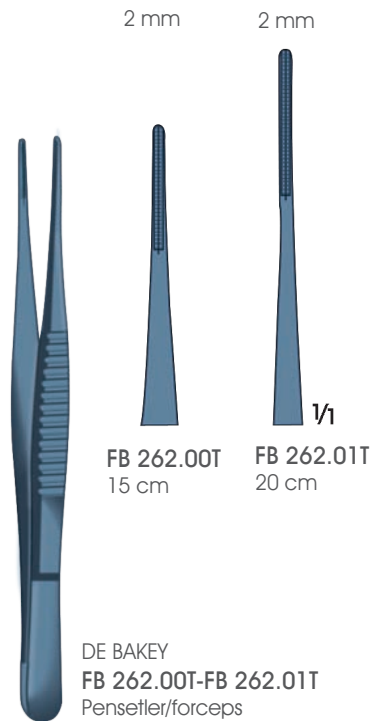
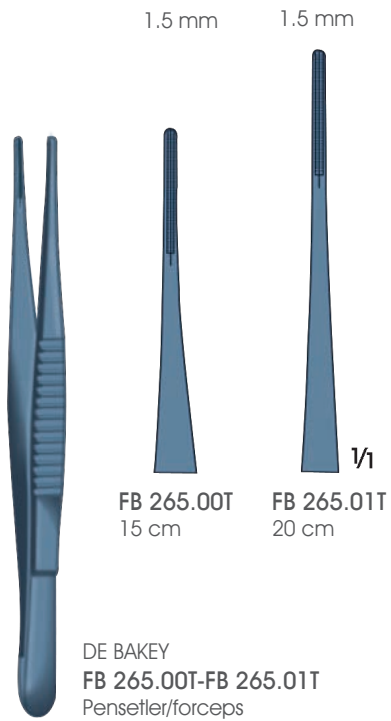
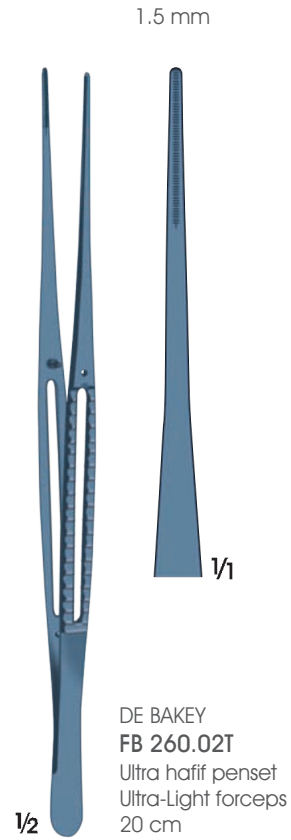
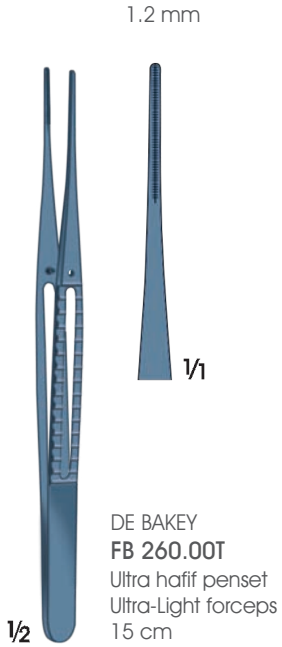

BF Spanç, Doku ve Çamaşır Pensleri
Sponge, Tissue and Washing Forceps



 **ARGENT**

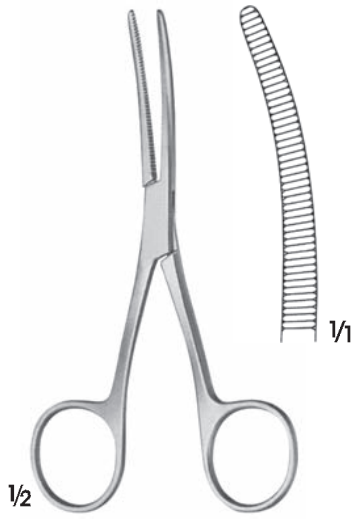

BRYANT
BF 004.00
13 cm



LISTER
BF 006.00-BF 008.00
Burun pensleri/Sinus forceps

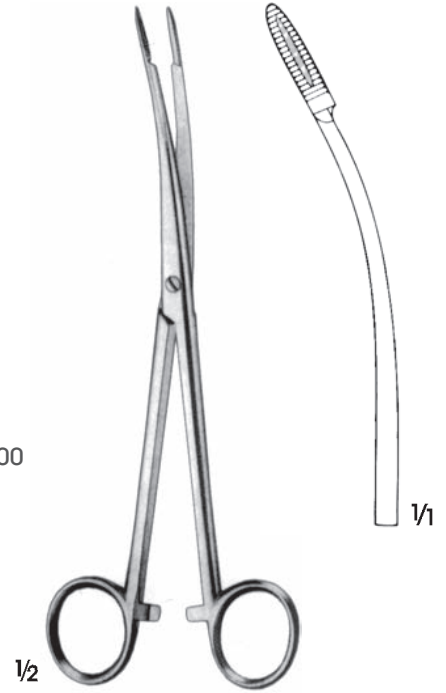

BF 019.00
17.5 cm

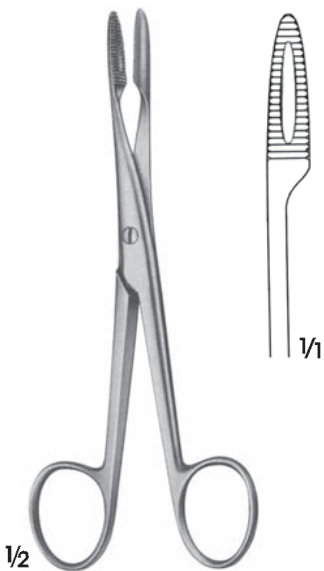

BF 010.00
Kilitli/ Without ratchet
14.5 cm

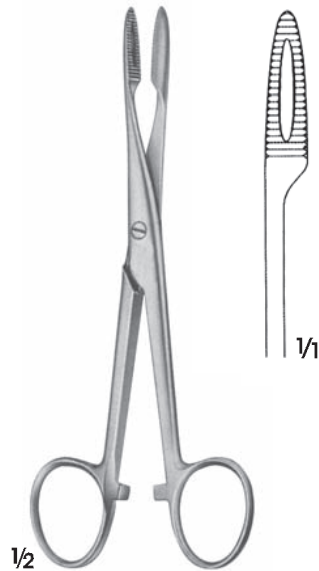

BF 011.00
Kilitli/ With ratchet
14.5 cm

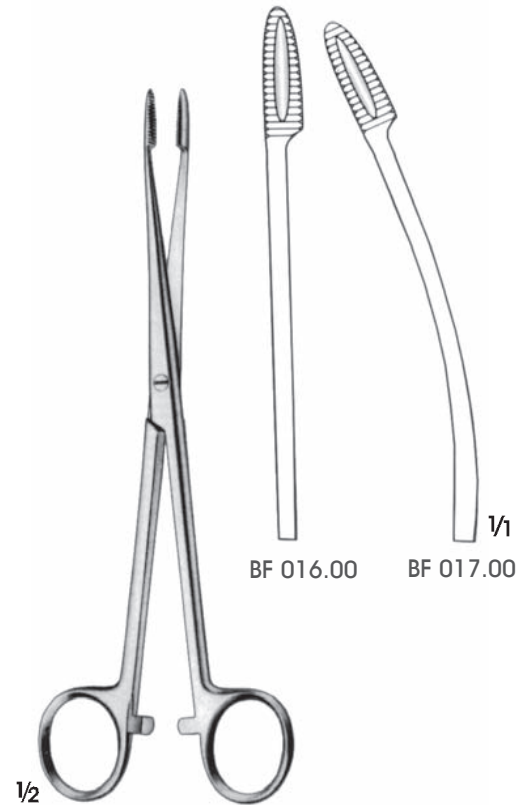

GROSS
BF 016.00-BF 017.00
Kilitli/ With ratchet 18 cm

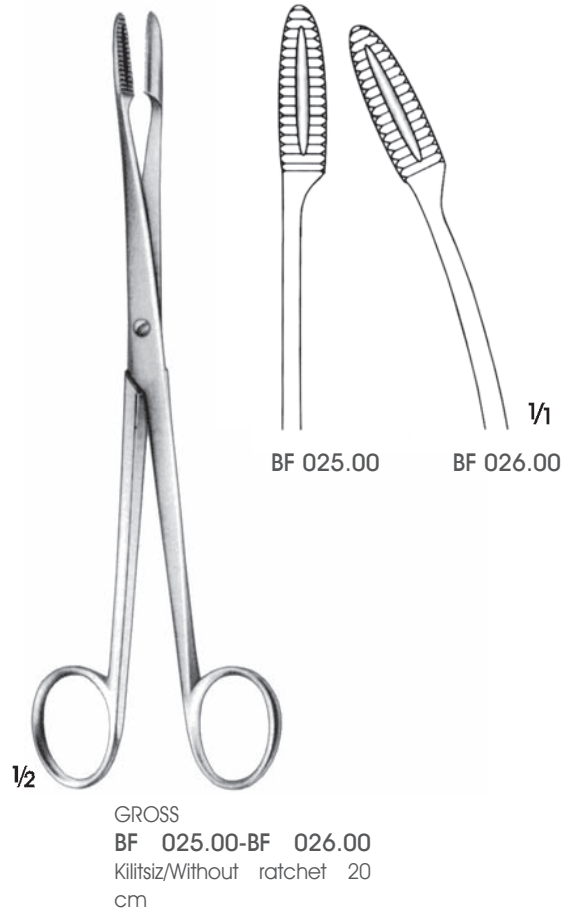
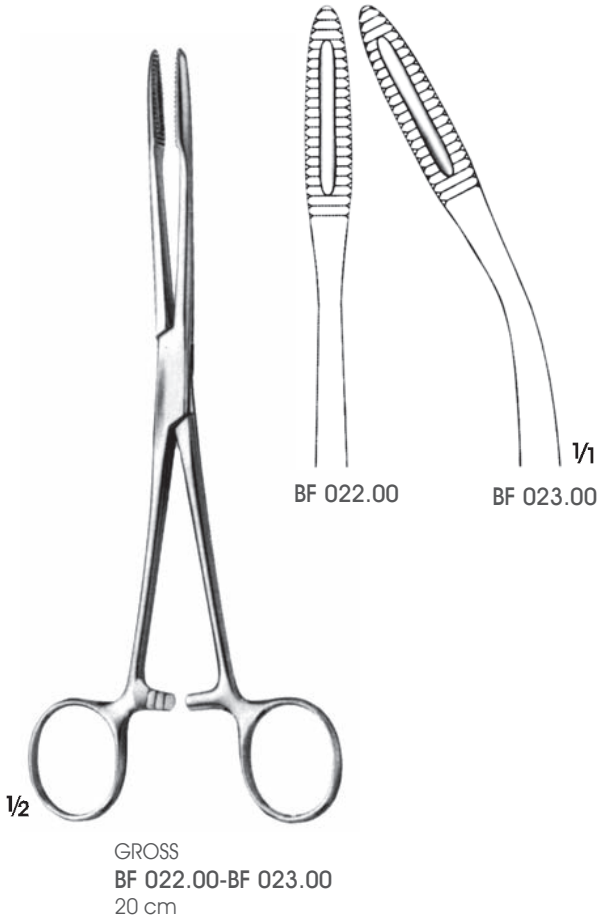

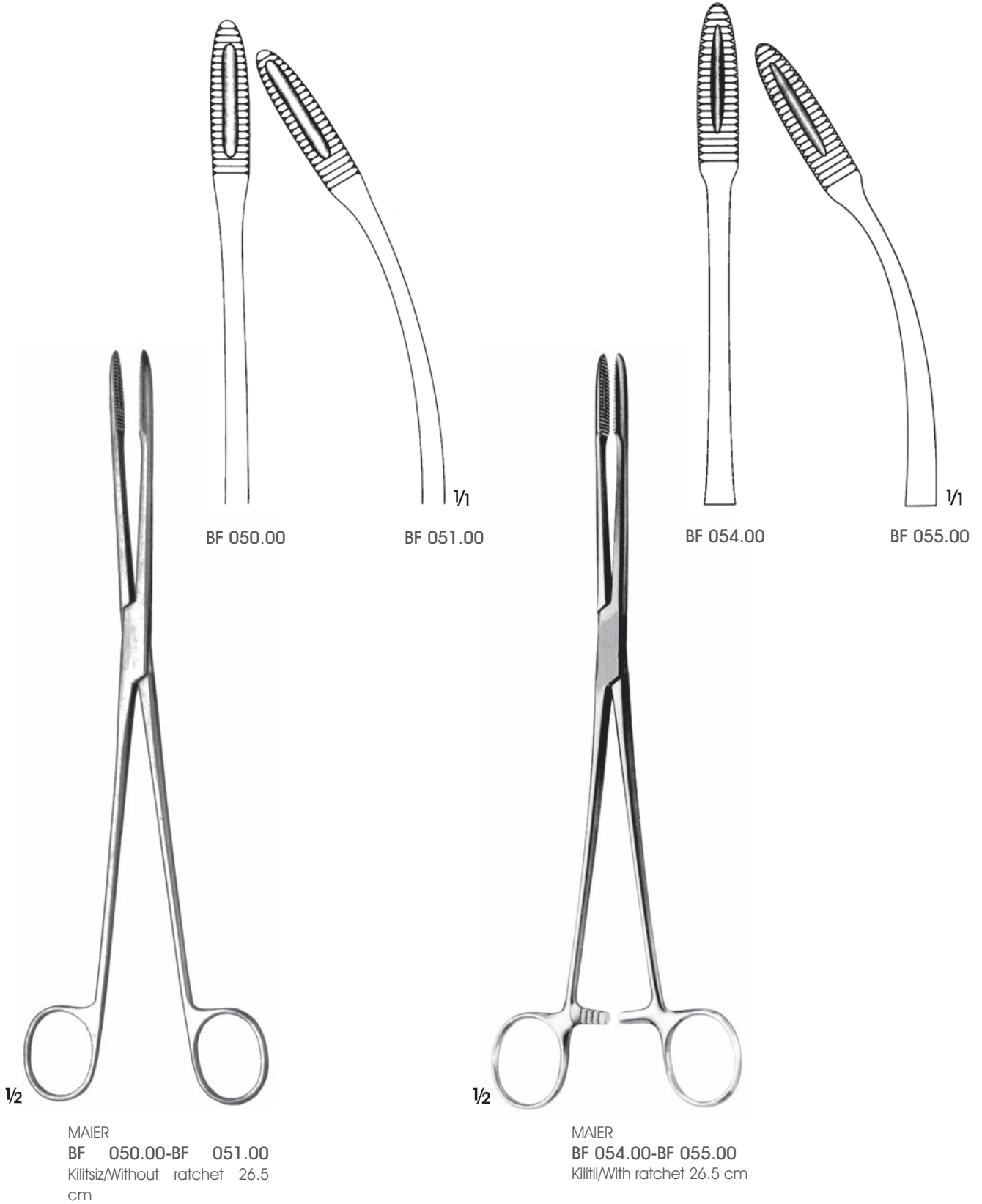



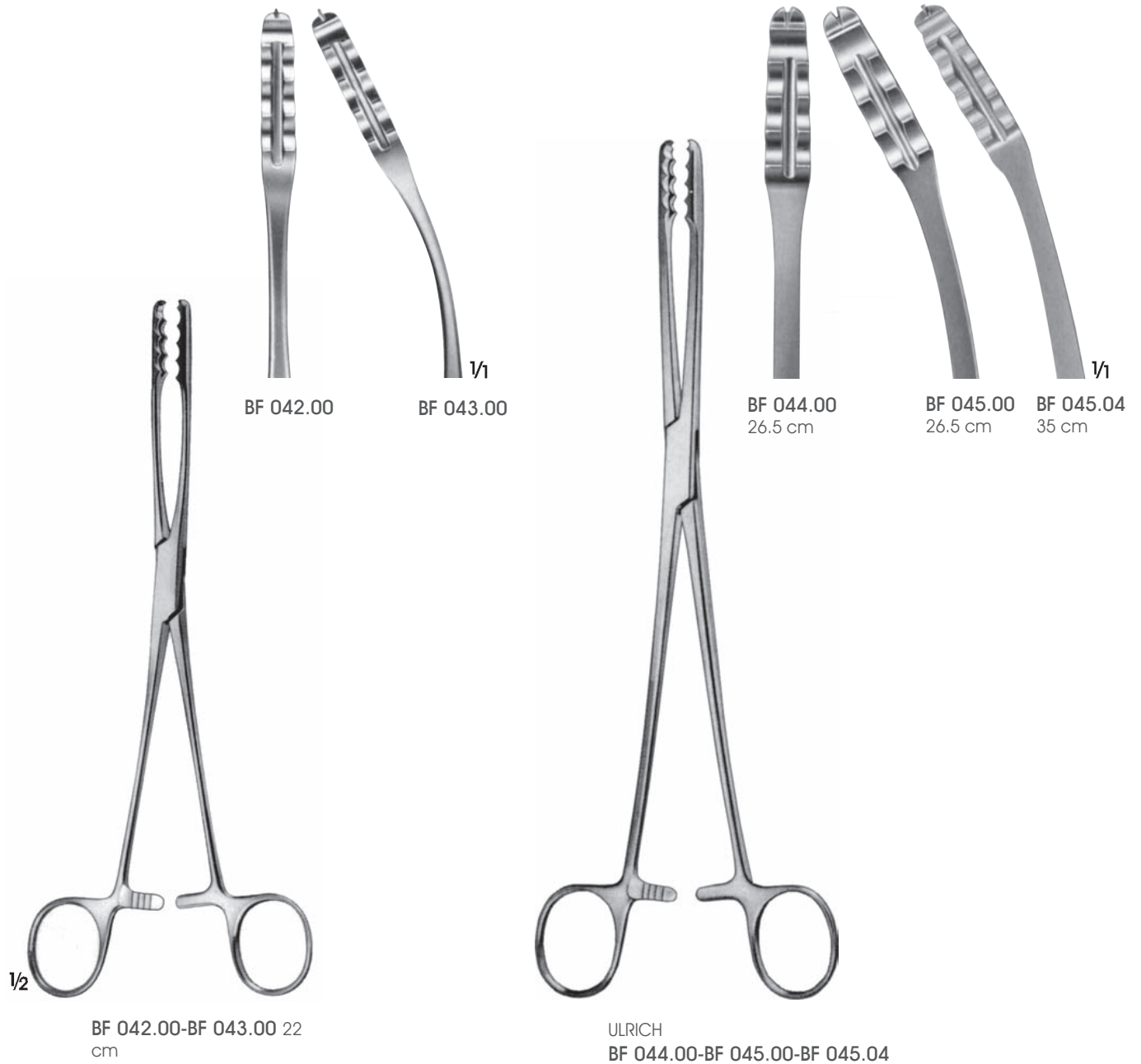



EMMET
BF 070.00
21 cm



COLLIN
BF 071.00
24 cm

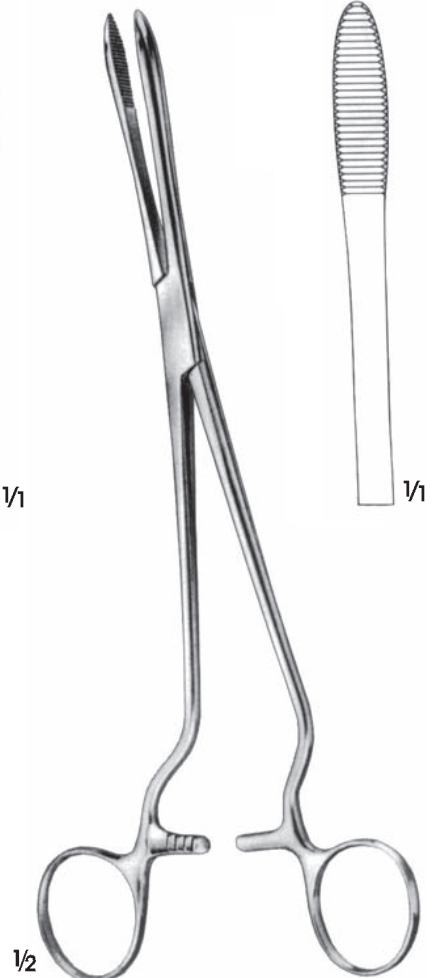

CHERON
BF 072.00
Açılı saplar
Handles angled to side
24 cm

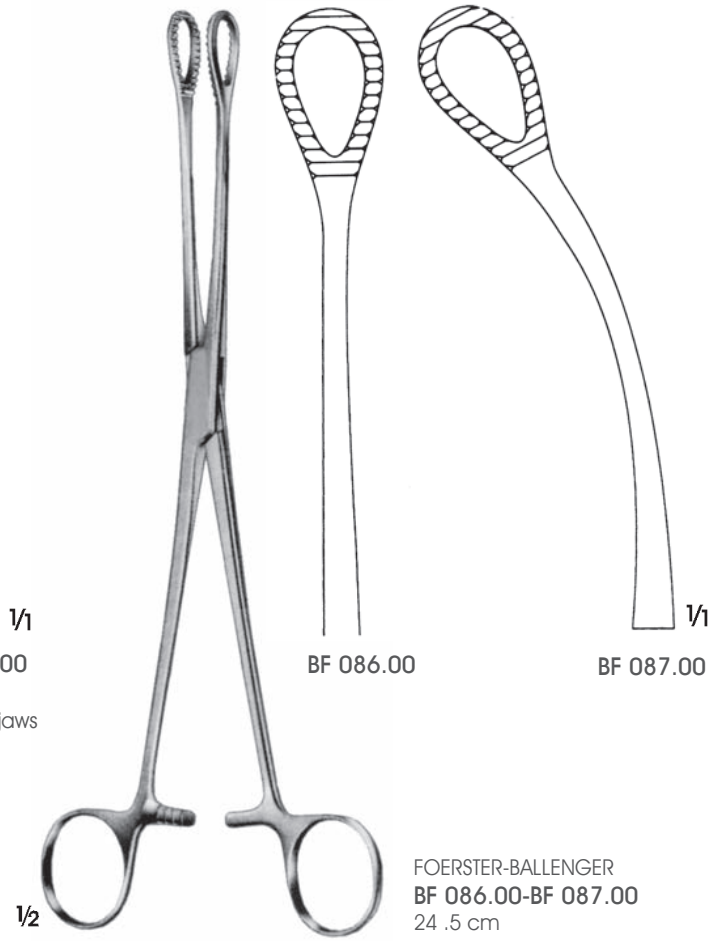
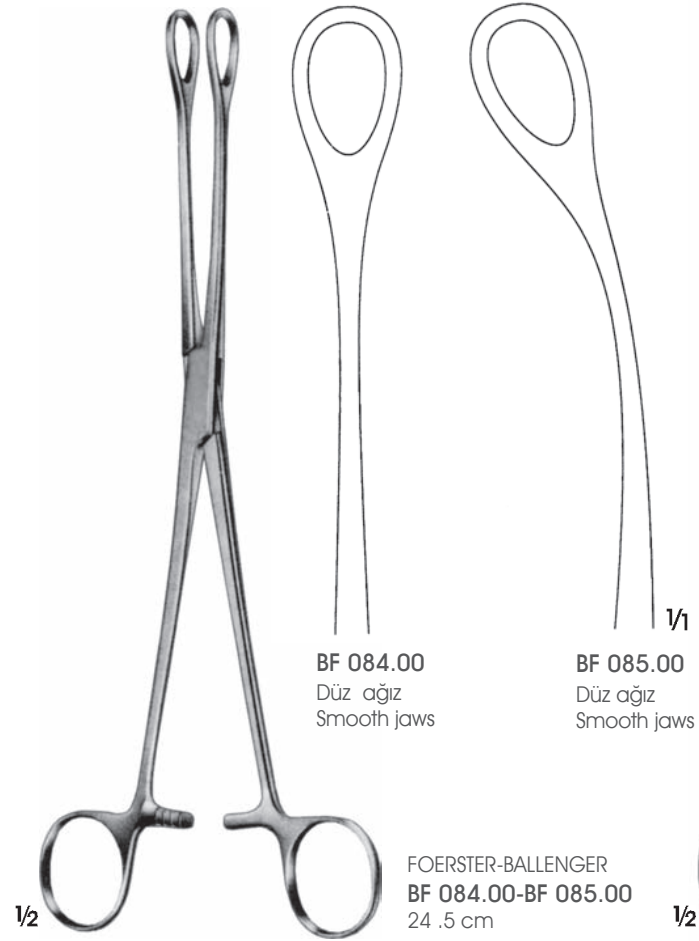
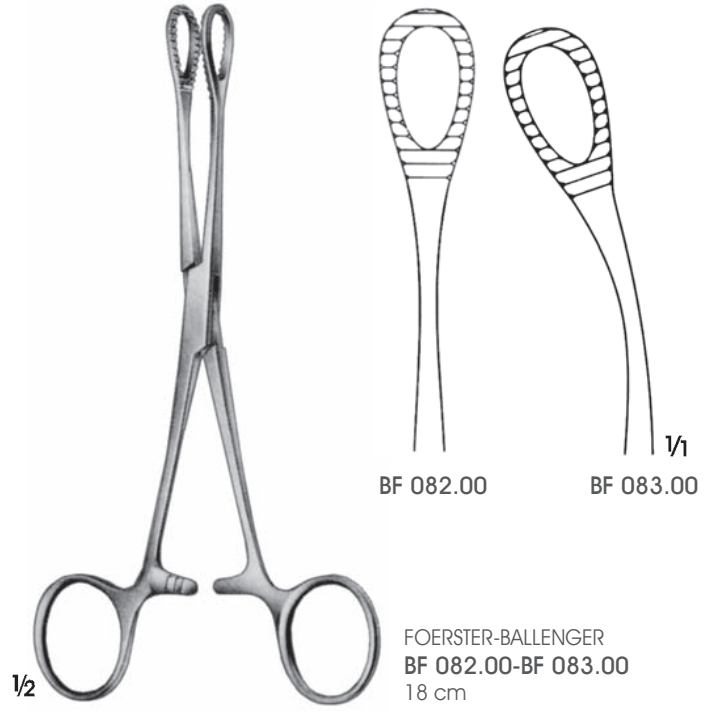
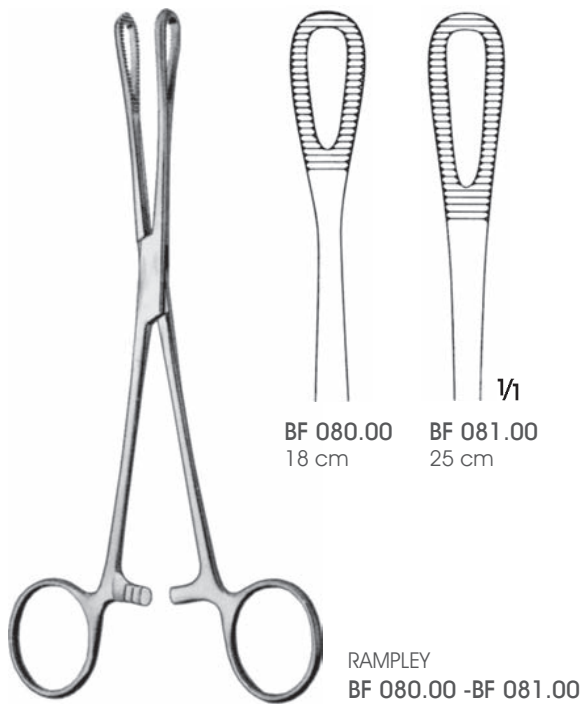

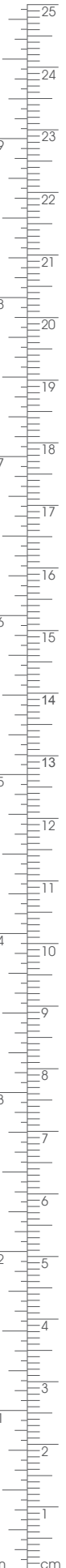
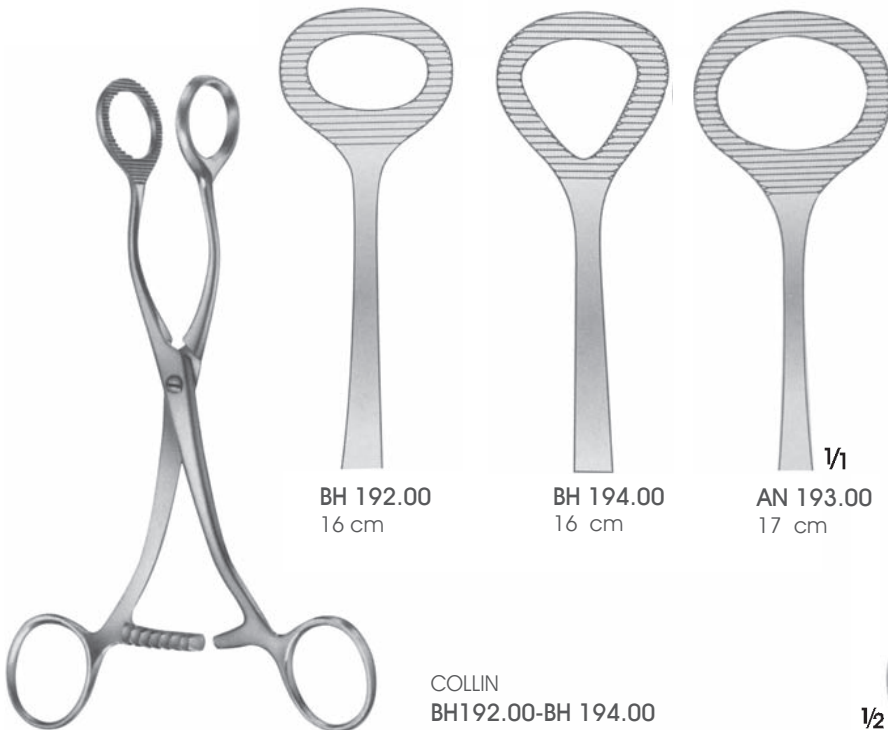
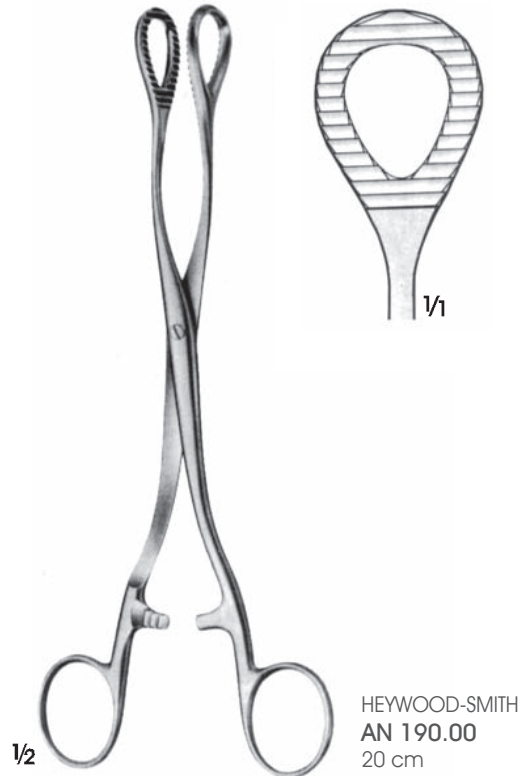
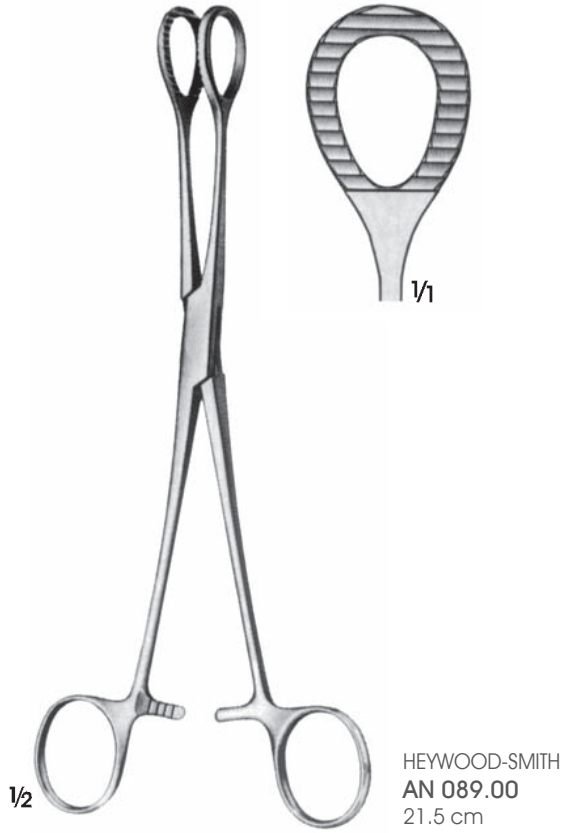

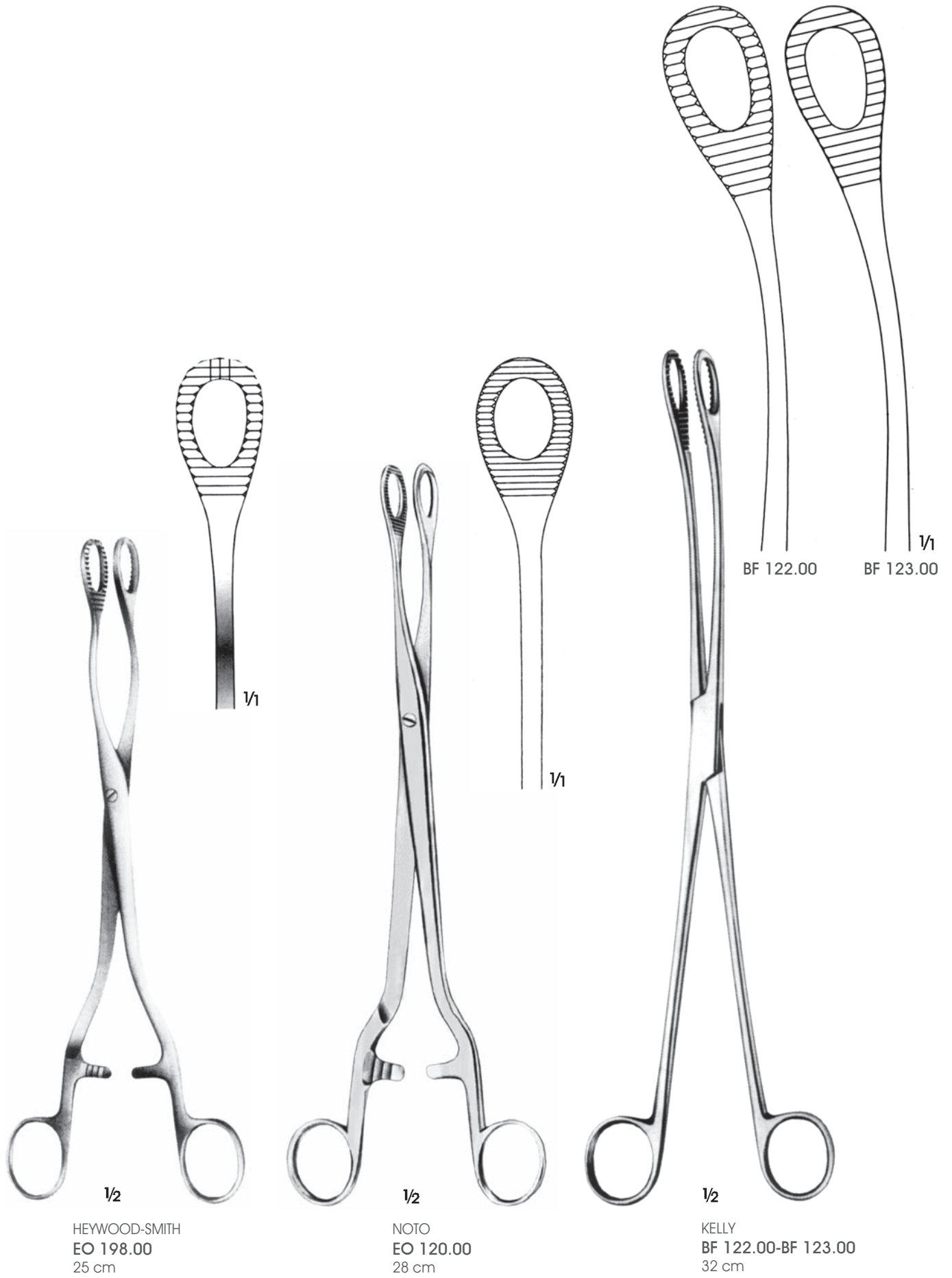

De Bakey Diş



Toothing De Bakey



2/3 sıra diş
2/3 teeth rows

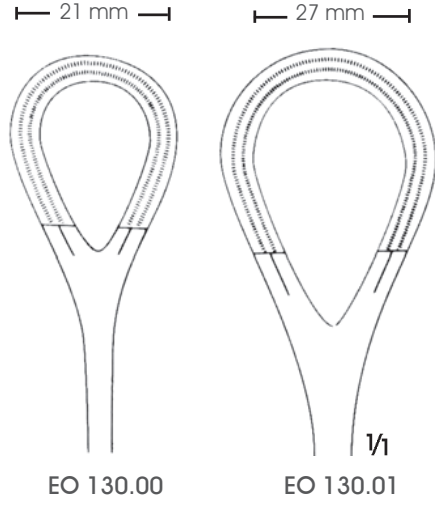
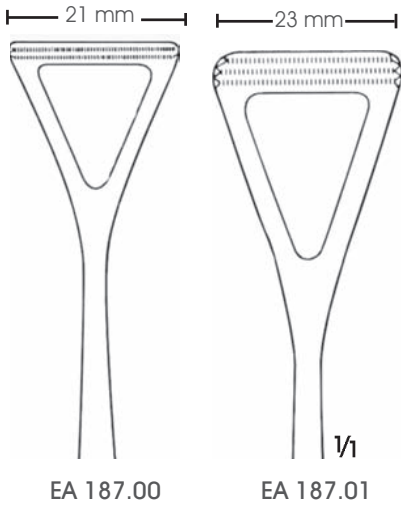

COLLIN
EA 187.00 19.5 cm
EA 187.01 23 cm



EO 130.00 25 cm
EO 130.01 27 cm

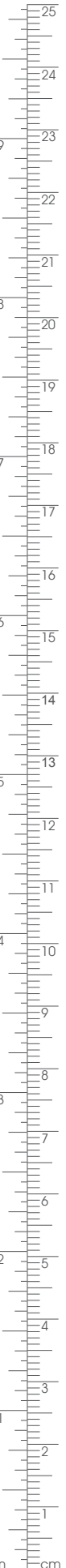

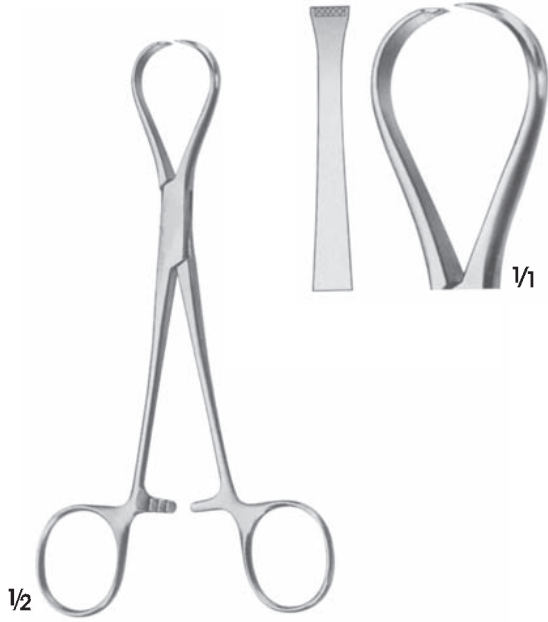

JACKSON
BF 300.00
Tendon tutucu pens
Tendon seizing forceps
4x5 diş/4x5 teeth
15 cm

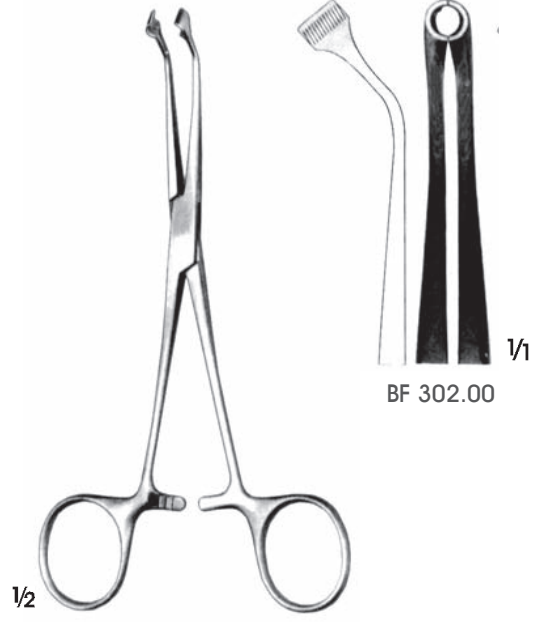

HERZ
BF 302.00-BF 302.01
Tendon tutucu pens
Tendon seizing forceps
15.5 cm



BF 310.00
Tendon geçmeli pens
Tendon seizing forceps
12 cm

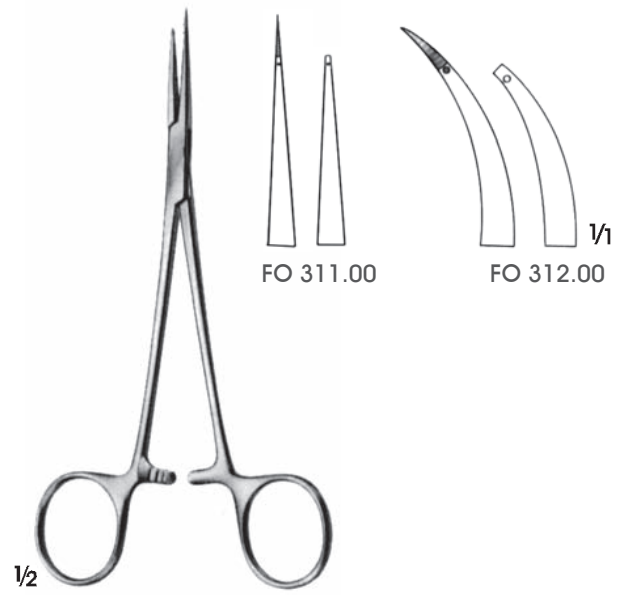

FO 311.00-FO 312.00
Tendon geçmeli pensleri
Tendon interlacing forceps
15 cm

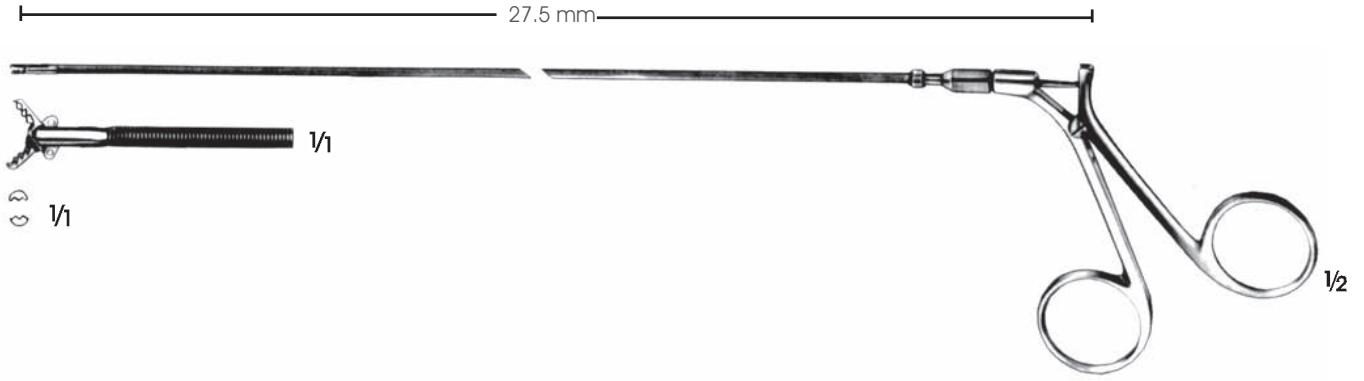

JAGER
BF 330.00
Tendon ve çapraz bağlara geçiş
sağlayan pens, esnek şaft
Tendon-and cross ligament passing
forceps flexible shaft
27.5 cm

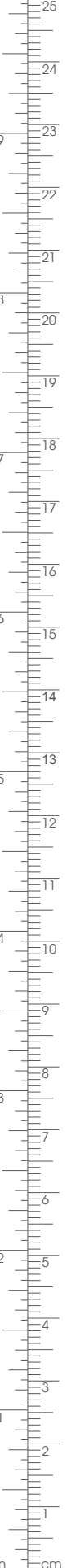

BRAND
BF 331.00-BF 332.01
Tendon tutma pensleri
Tendon holding forceps



BF 331.00
Düz/Straight
18.5 cm



BF 331.01
Eğri/Curved
18.5 cm

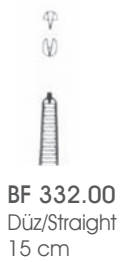

BF 332.00
Düz/Straight
15 cm

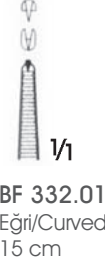

BF 332.01
Eğri/Curved
15 cm



BF 338.00
Tendon geçiş pens
Tendon passing forceps
20.5 cm



1/2

POIRIER
 EA 148.00
 2 x 3 diş
 2 x 3 teeth
 12.5 cm



1/2

CHAPUT
 BF 140.00
 2 x 3 diş, sivri
 2 x 3 teeth, sharp
 12.5 cm



1/2

TUFFIER
 BF 141.00
 5 x 6 diş, sivri
 5 x 6 teeth, sharp
 12.5 cm

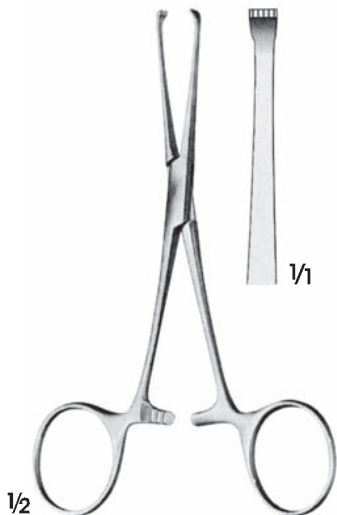

1/2

BABY-ALLIS
 EA 142.00
 4 x 5 diş/4 x 5 teeth
 13 cm



1/2

BOYS-ALLIS
 EA 143.00
 5 x 6 diş/5 x 6 teeth
 15.5 cm

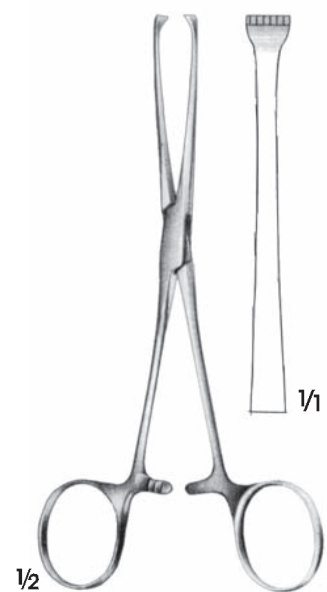

1/2

ALLIS
 EA 144.00
 5 x 6 diş/5 x 6 teeth
 15.5 cm

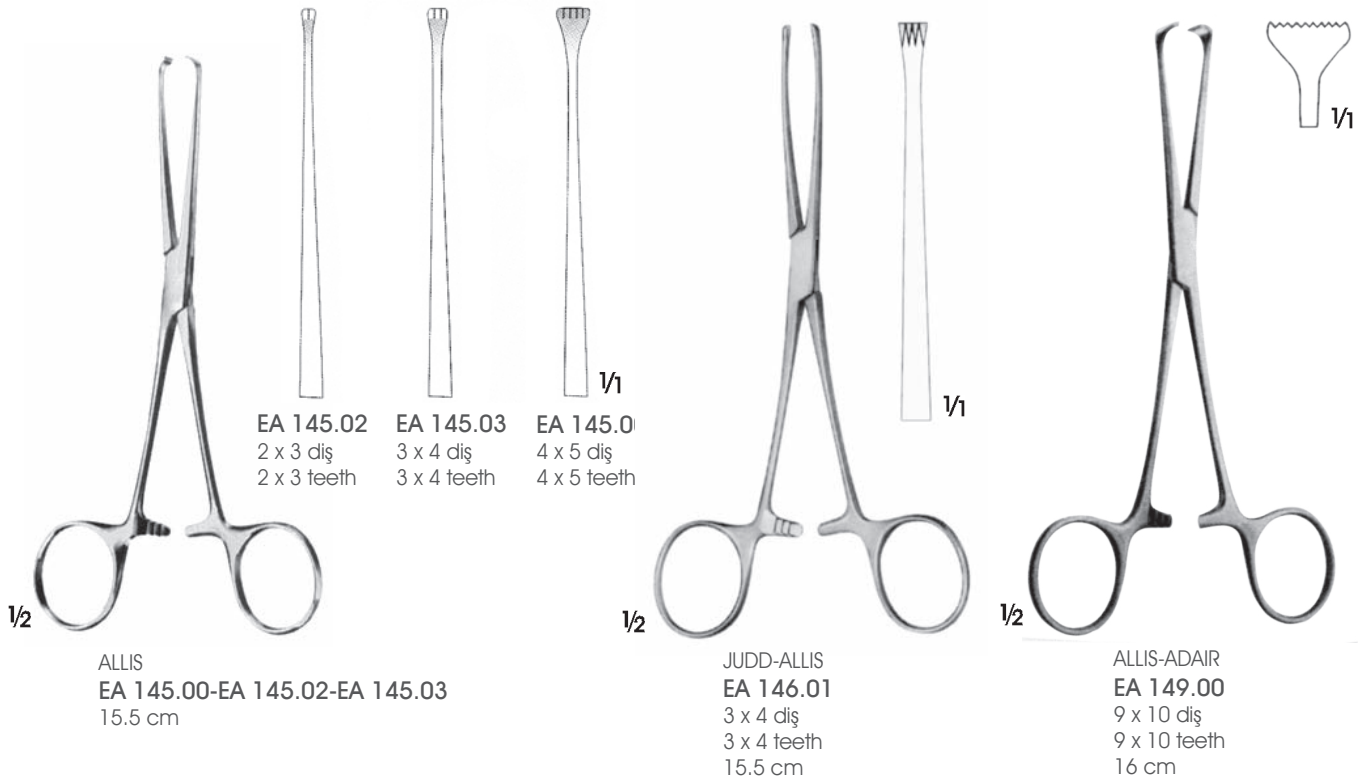

Atromatik
Atraumatic

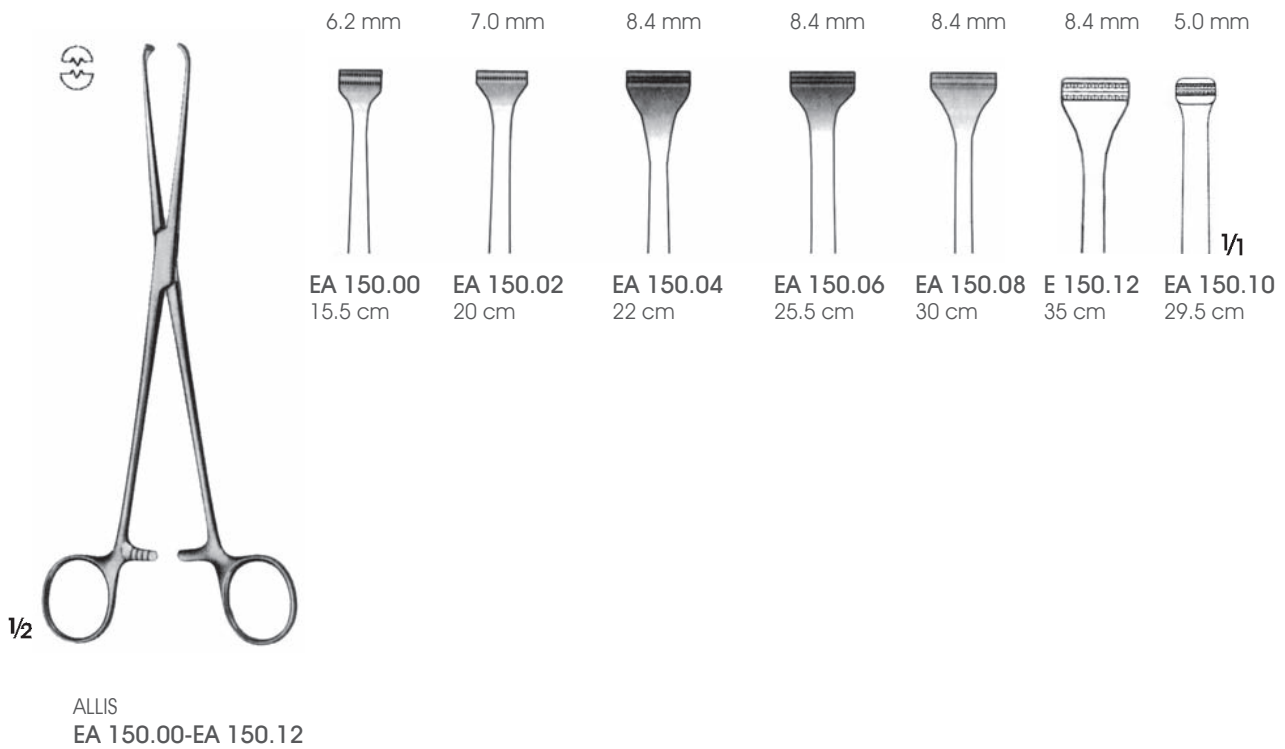

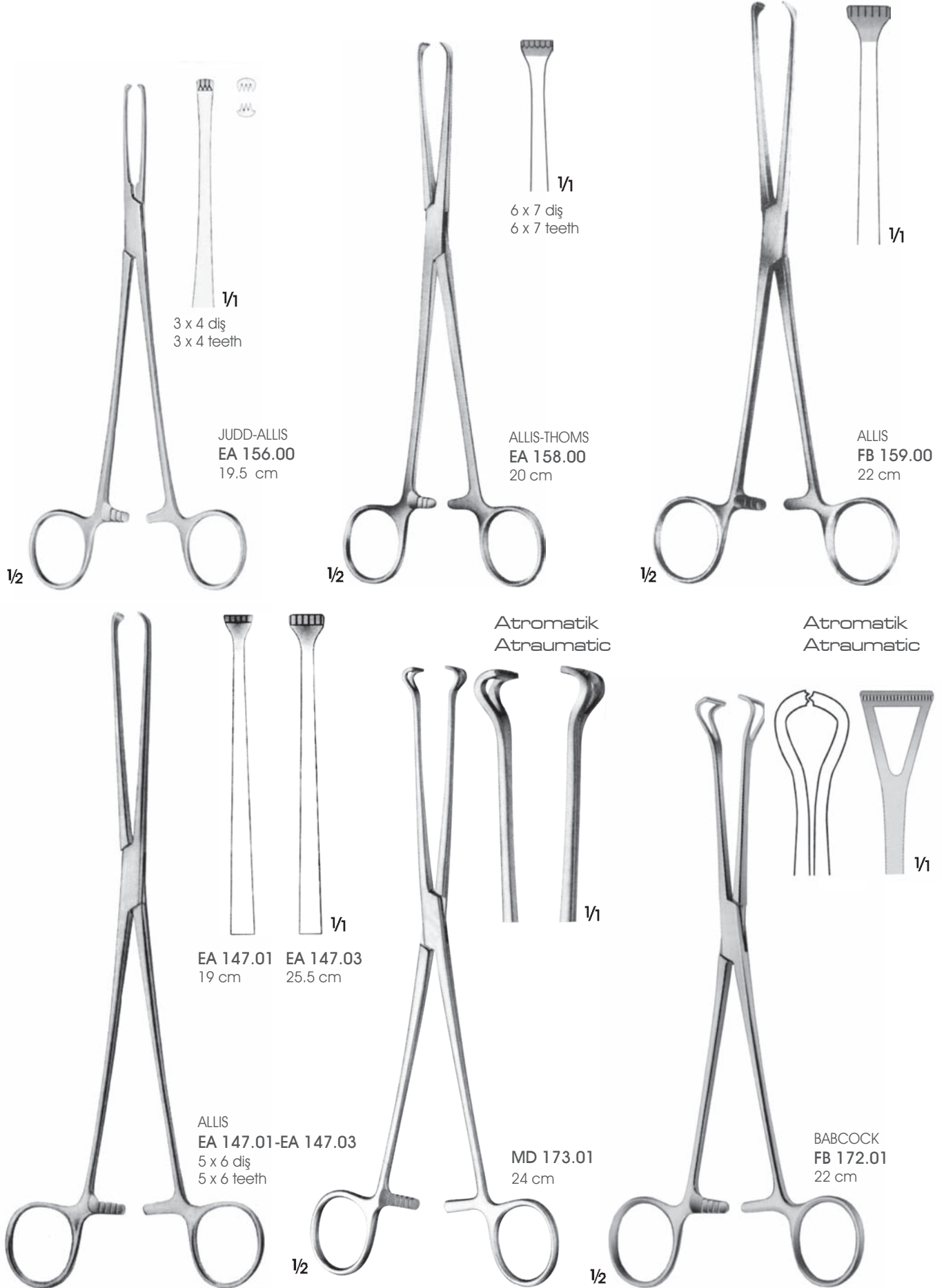

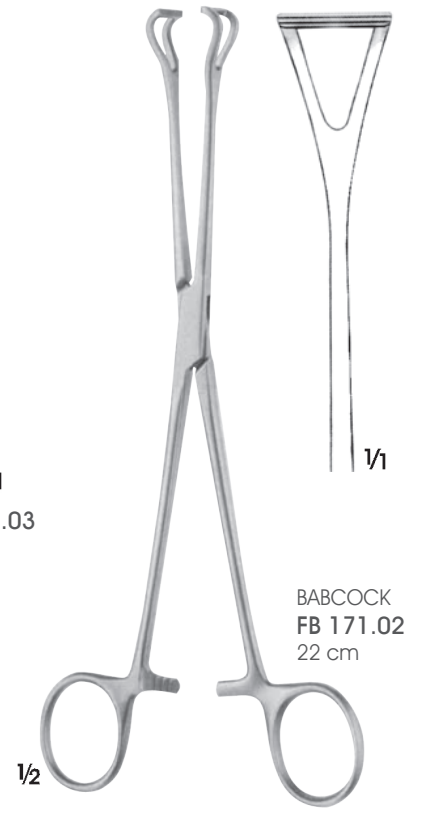
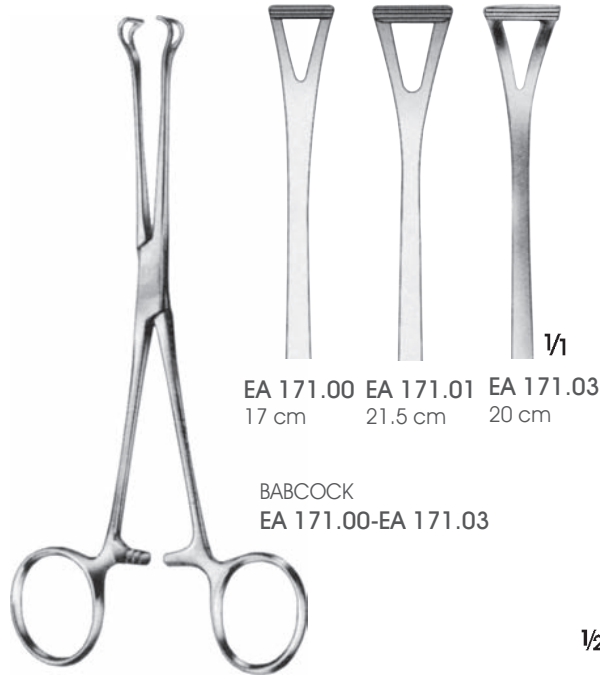

Atromatik
Atraumatic

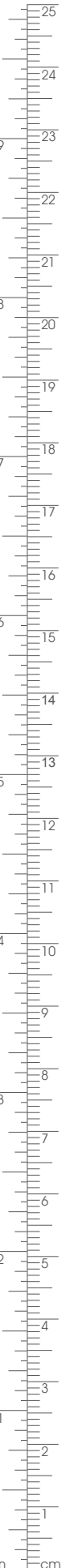
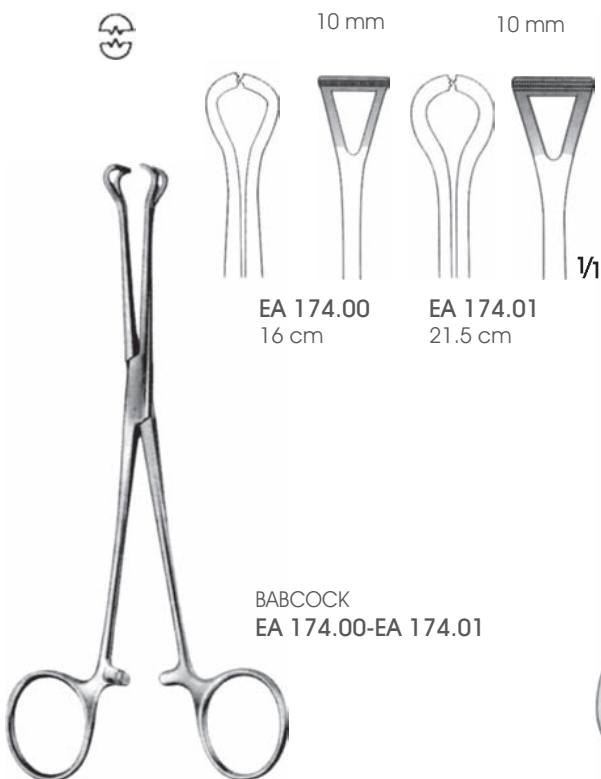

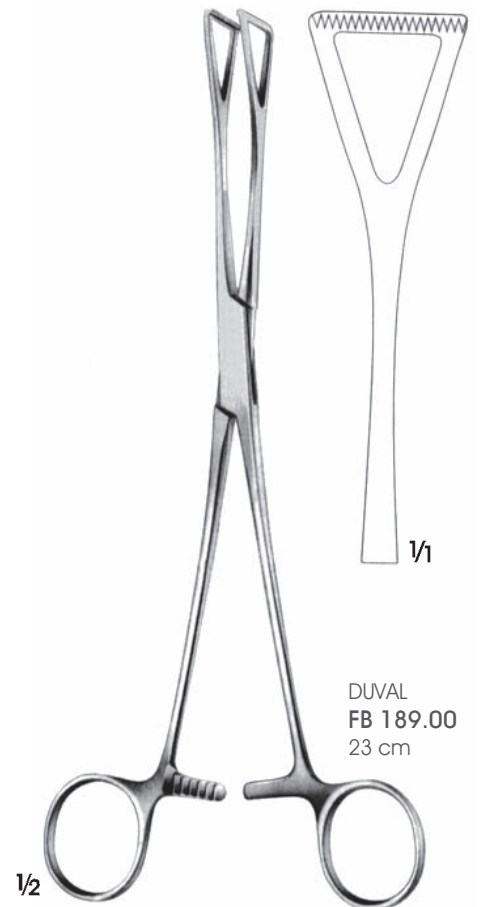
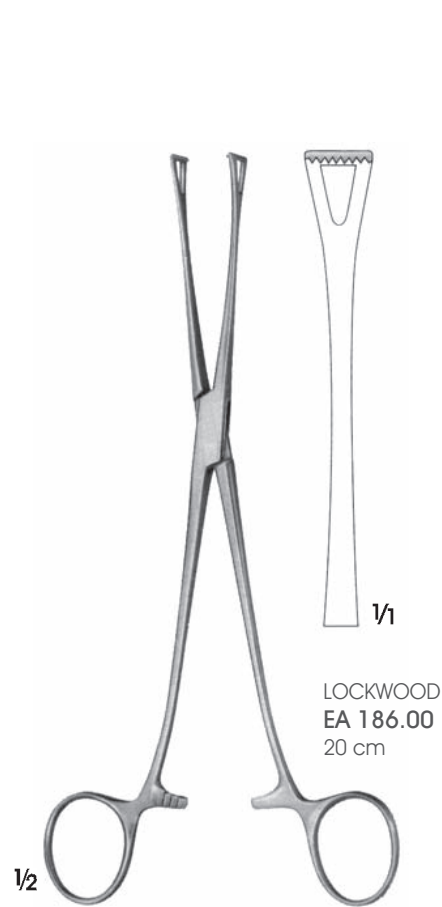
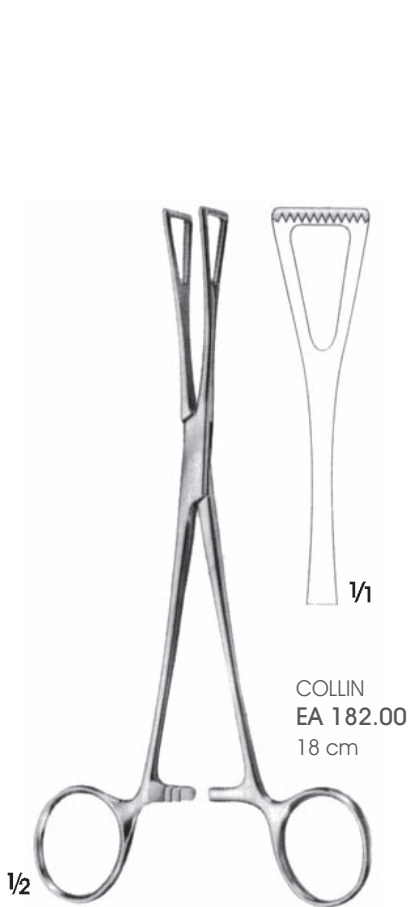
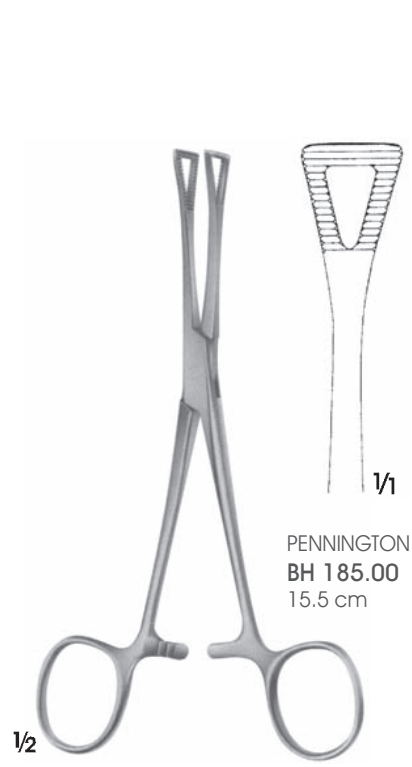
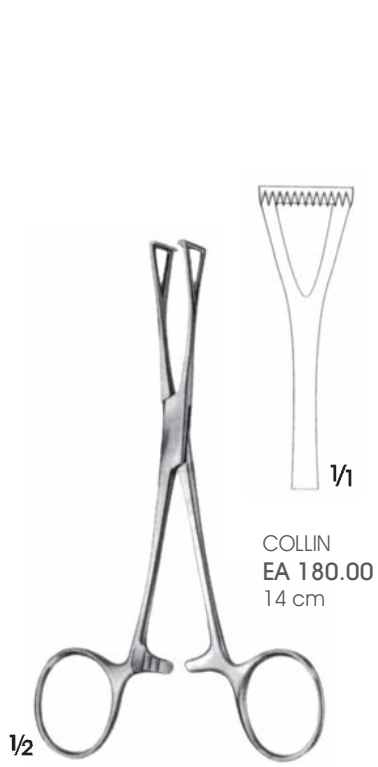

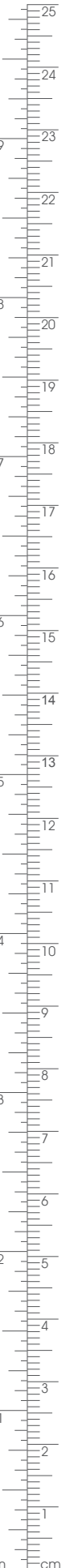
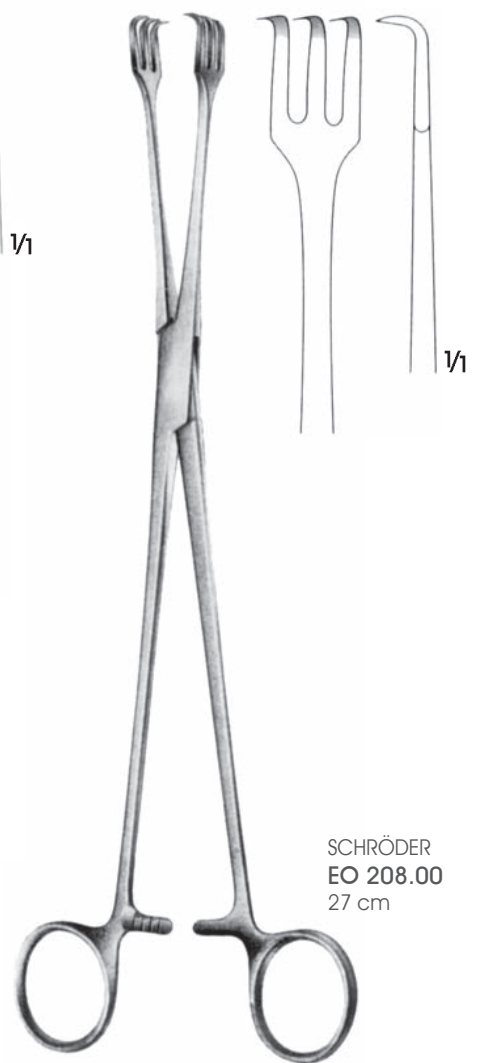
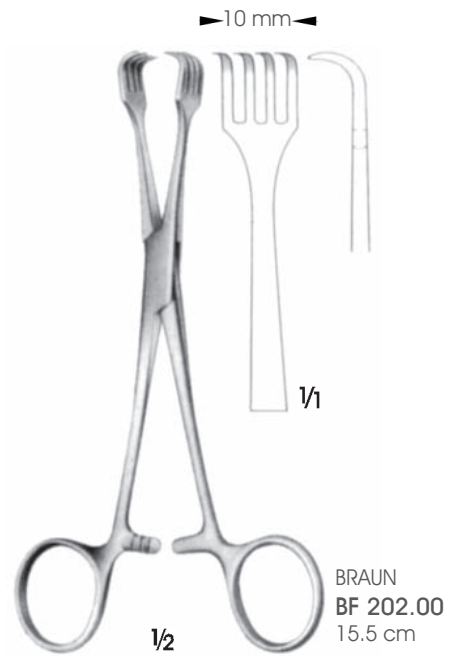
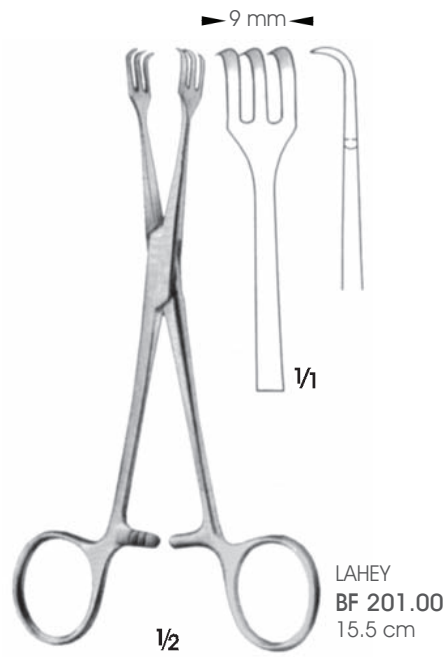
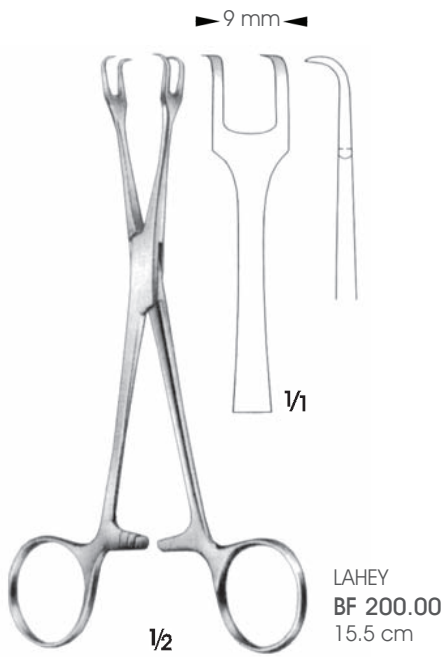

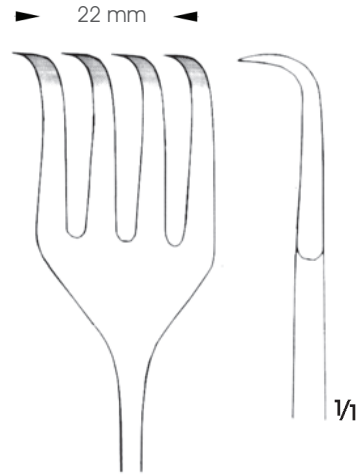
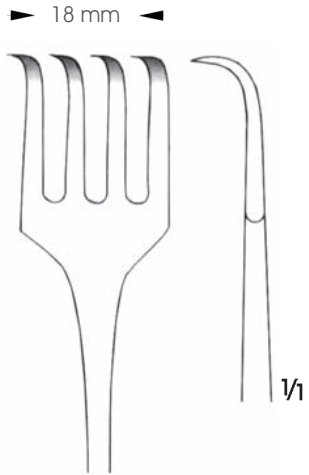

EO 210.00
26 cm



PRATT
EO 211.00
27 cm

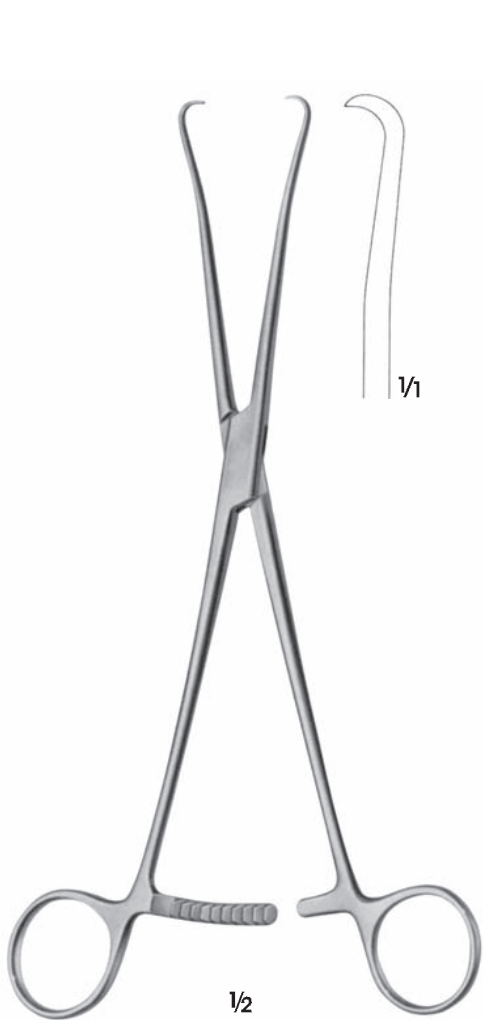

WILSON
EO 252.00
24 cm



SCHRÖDER
EO 251.00
25 cm



POZZI
EO 255.01
25.5 cm

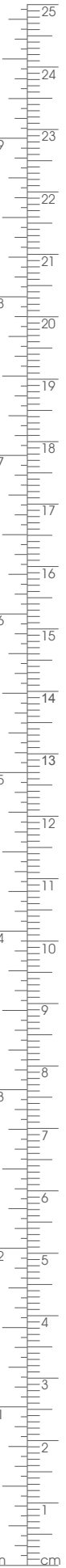

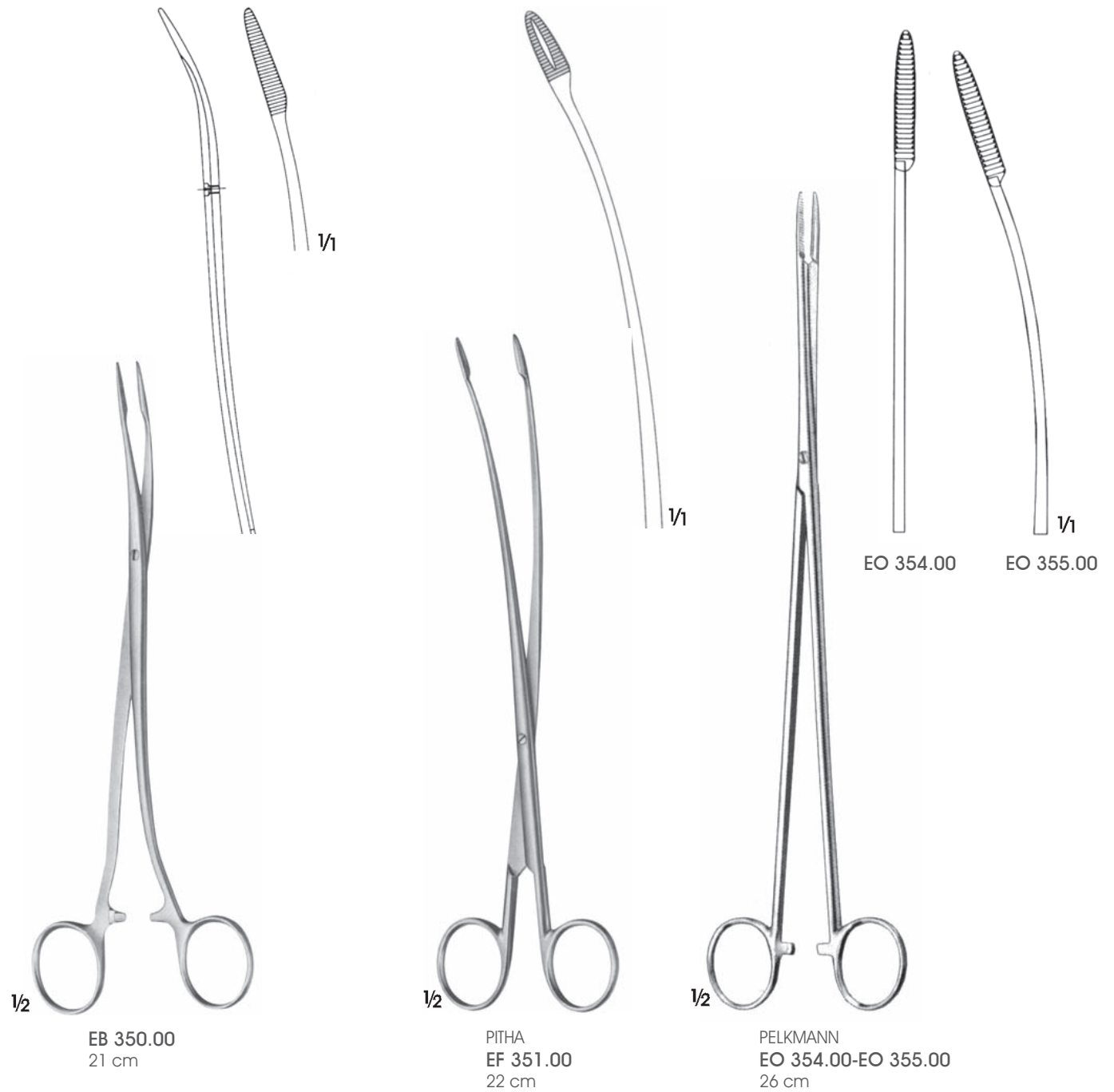

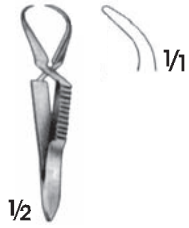

BF 400.00
5.5 cm



ENGL.MOD
BF 401.00
8.5 cm

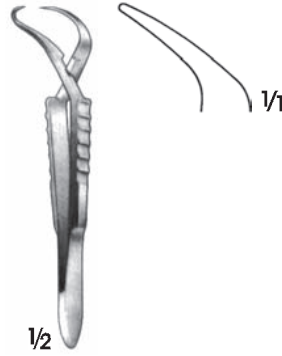

JONES
BF 402.00
8.5 cm

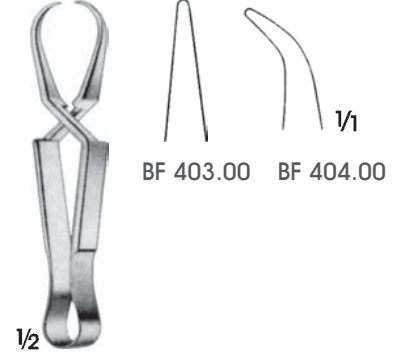

SCHAEDEL
BF 403.00-BF404.00
8.5 cm



DOYEN
BF 410.00
11 cm



DOYEN
BF 412.00
18 cm

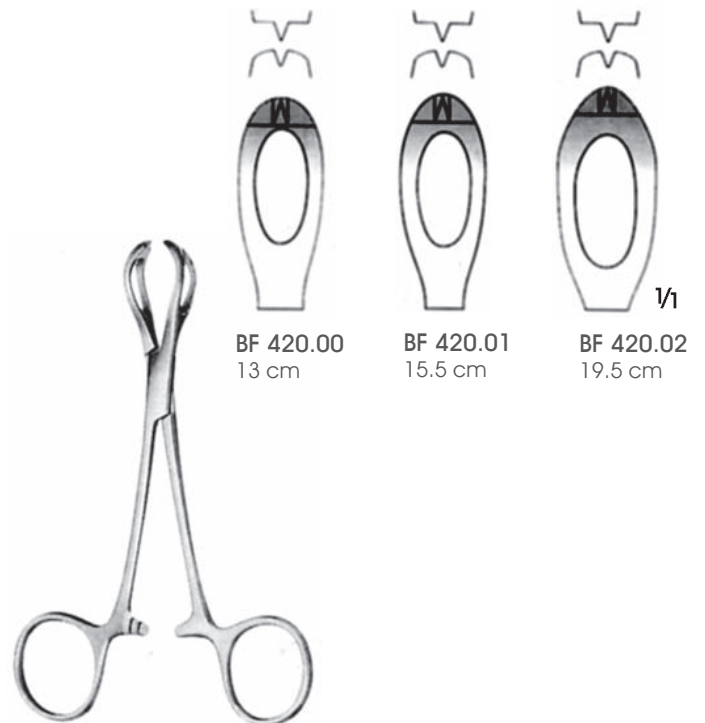

LANE
BF 420.00-BF 420.02



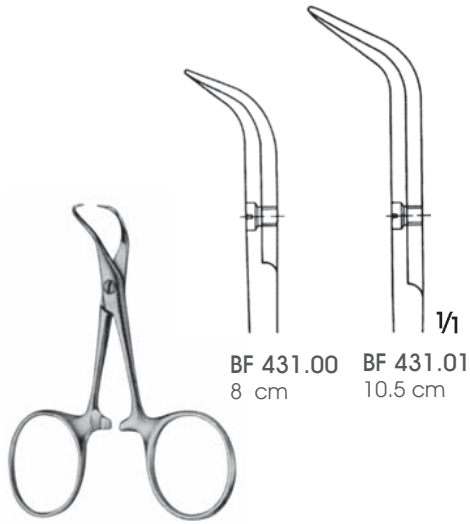

BF 431.00 8 cm
BF 431.01 10.5 cm

BACKHAUS
BF 431.00-BF 431.01

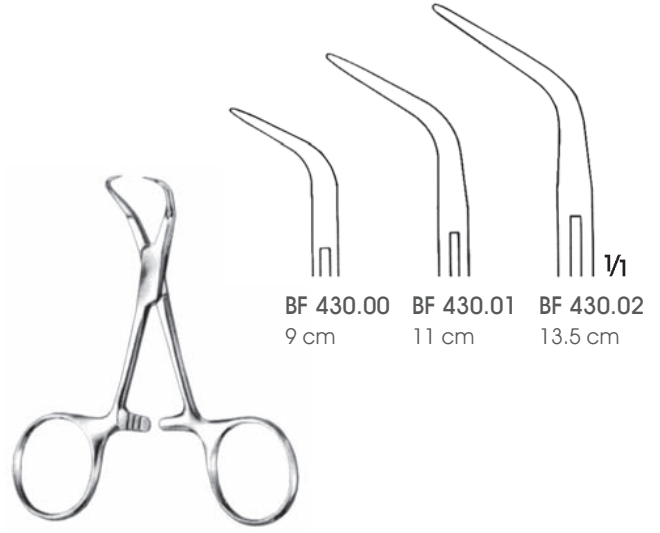

BF 430.00 9 cm
BF 430.01 11 cm
BF 430.02 13.5 cm

BACKHAUS
BF 430.00-BF 430.02

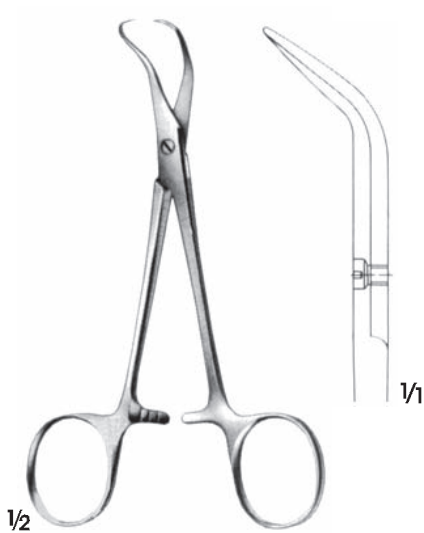

BACKHAUS-KOCHER
BF 439.00
13.5 cm

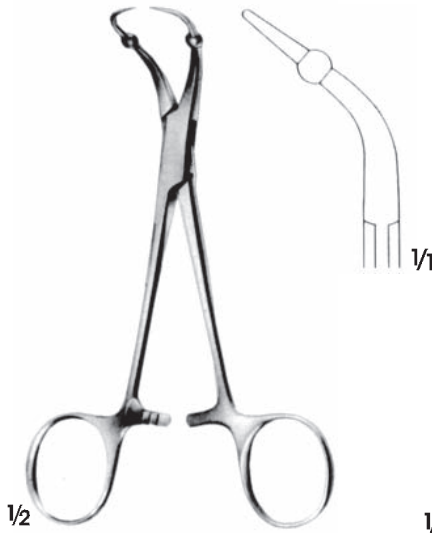

ROEDER
BF 442.00
13.5 cm

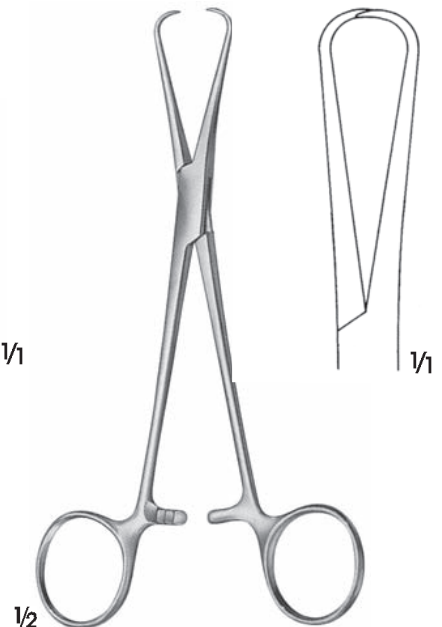

BERNHARD
BF 444.00
16 cm

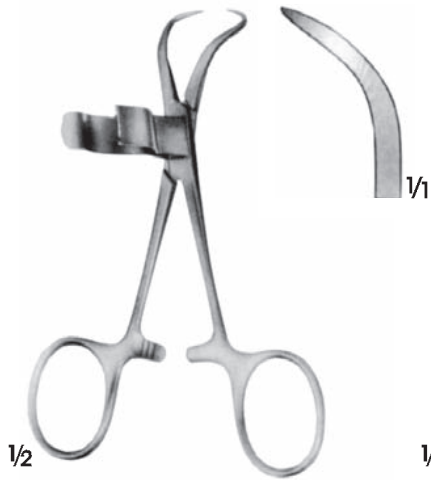

BF 450.00
15 mm kadar tüp tutucu
With holders for tubing up to 15 mm
11 cm



ROBIN
BF 451.01
13 mm kadar tüp tutucu
With holders for tubing up to 13 mm
13.5 cm

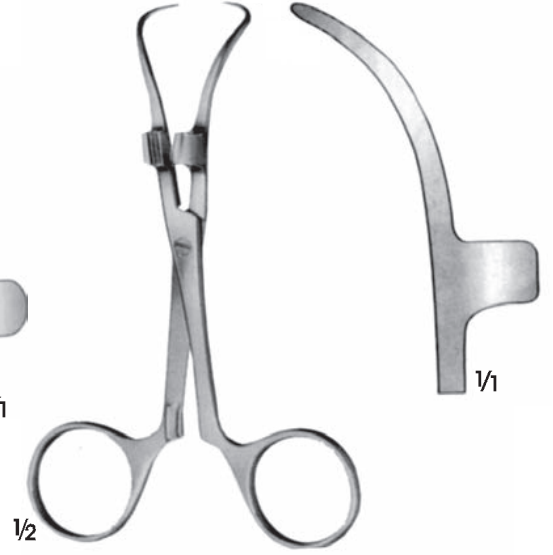

ROBIN
BF 451.00
5 mm kadar kablo tutucu
With holders for cable up to 5 mm
13.5 cm



BF 440.00
Kağıt örtüler için
For paper cloths
14 cm

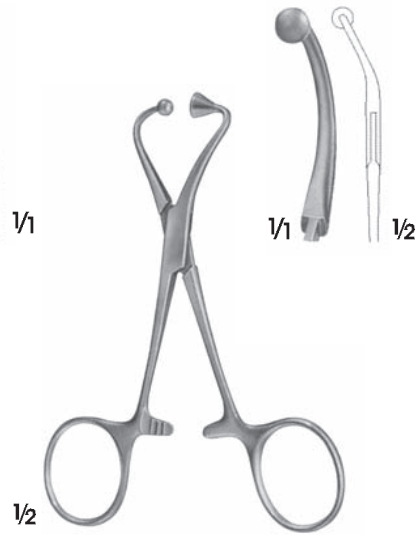

BF 440.05
Kağıt örtüler için
For paper cloths
11.5 cm

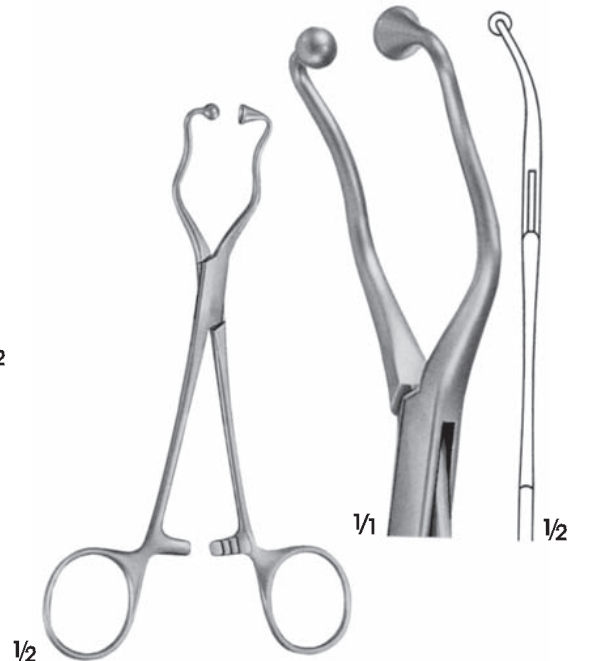

BF 446.00
Tüp sabitleyici pens
Tube fixation forceps with
atraumatic jaw parts
14 cm





LORNA
BF 460.00
Delmeden tutucu klempl
Non-perforating
9.5 cm

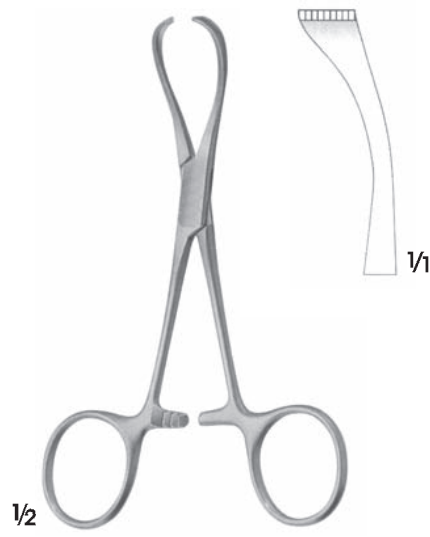

LORNA
BF 461.01
Delmeden tutucu klempl
Non-perforating
13 cm

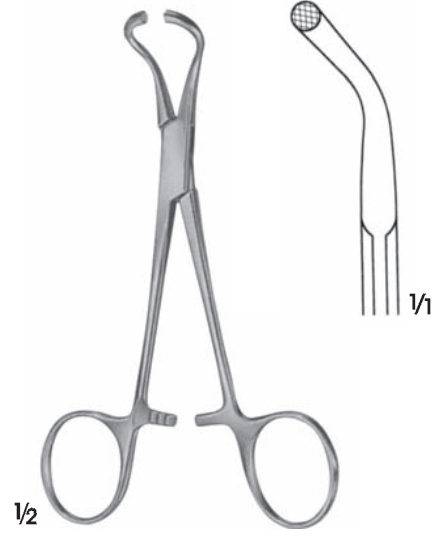

BF 462.00
Bez örtüler için
For towel cloths
13.5 cm

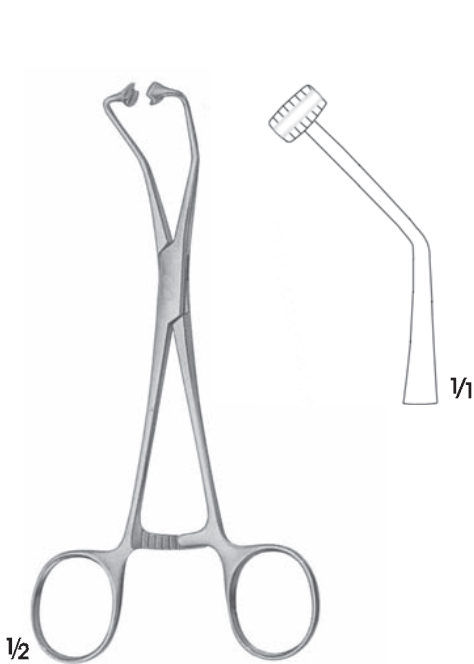

BF 464.00
Kağıt örtüler için
For paper cloths
15 cm

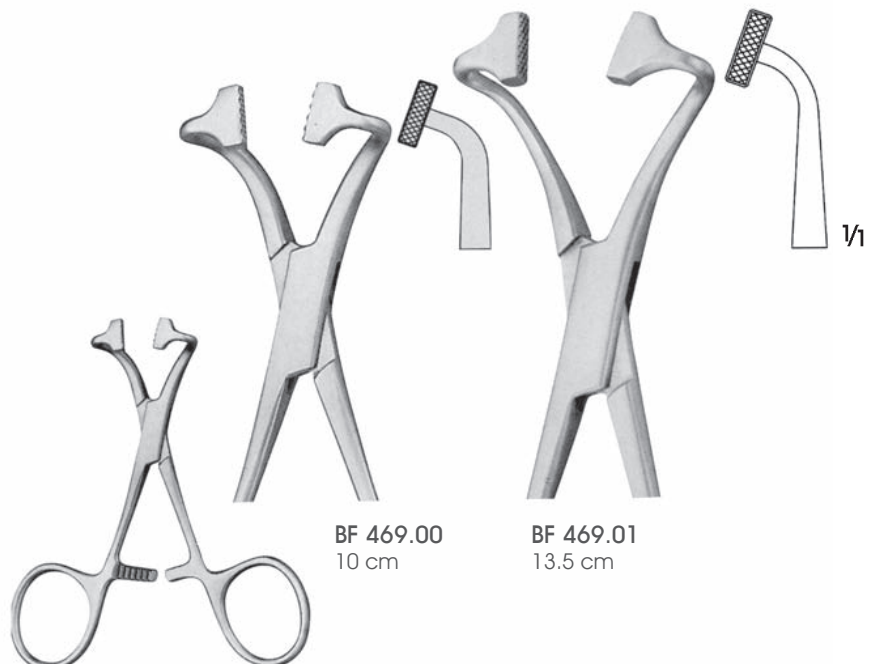

BF 469.00
10 cm

BF 469.01
13.5 cm

BF 469.00-BF 469.01
Delmeden tutucu klempl
Non-perforating



BUNT
BF 480.00
10.5 cm

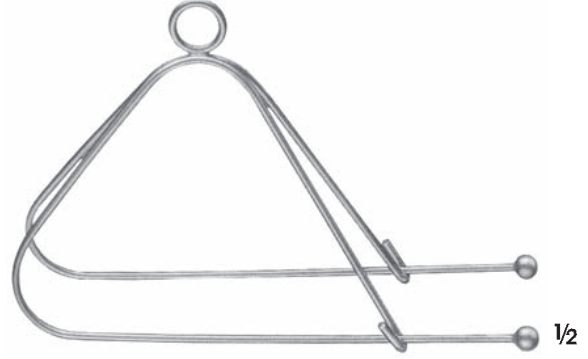

MAYO
BF 482.00
Çift/double
12.5 cm



MAYO
BF 481.00
14 cm



1/3
CHEATTLE
JG 500.00
Sterilizatör pens
Sterilizing forceps
28 cm



JG 510.00 20 cm
JG 510.01 30 cm
Sterilizatör pensleri
Sterilizing forceps



BM Portegüler ve Sütur Aletleri
Needle Holders and Suture Instruments



 ARGENT

Düz Saplar/Flat Handles

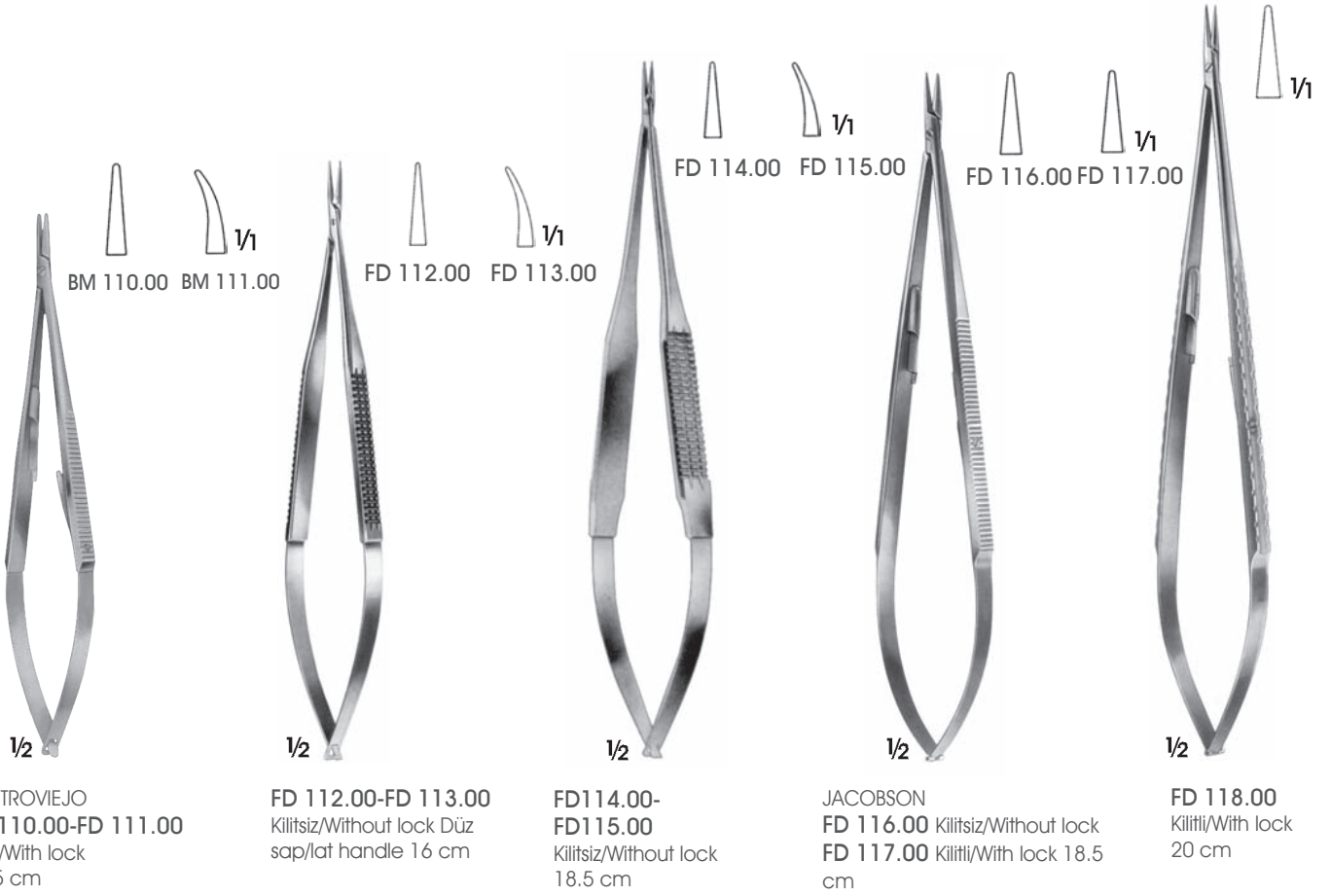

CASTROVIEJO
FD 110.00-FD 111.00
Kilitli/With lock
14.5 cm

FD 112.00-FD 113.00
Kilitsiz/Without lock Düz
sap/lat handle 16 cm

FD 114.00-
FD 115.00
Kilitsiz/Without lock
18.5 cm

JACOBSON
FD 116.00 Kilitsiz/Without lock
FD 117.00 Kilitli/With lock 18.5
cm

FD 118.00
Kilitli/With lock
20 cm



FM 139.00
Kilitsiz/Without
lock 20 cm

FM 139.10
Kilitli/With lock
23 cm

FM 139.00-FM 139.10
Yuvarlak saplı portegü
Needle holders
with round handles

Ergonomik, hafif plastik sap
yorulmadan optimum kullanım
sağlar.

Ergonomic, light weight plastic
handle provides fatigue free,
optimal usage.

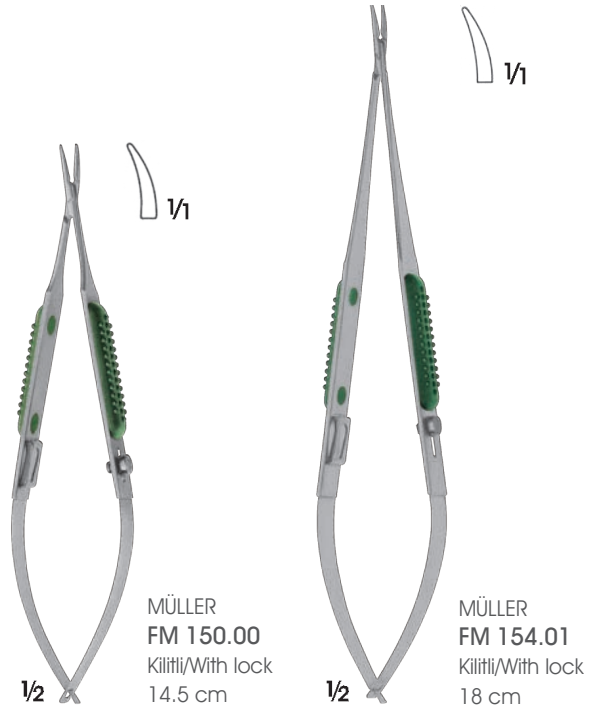

MÜLLER
FM 150.00
Kilitli/With lock
14.5 cm

MÜLLER
FM 154.01
Kilitli/With lock
18 cm

Yuvarlak Saplar

Parmaklar arasında istenildiği şekilde döndürmeye izin verir.

Sağlam veya oyulmuş saplardan dolayı her bir alette optimum denge sağlar

Round Handle

Allows rotation between the fingers as required

Due to carved and strong handle, each instrument provides optimum balance



1/2
BARRAQUER
FD 120.00-FD 121.00
Kilitli/With lock
12 cm



1/2
BARRAQUER
FD 122.00-FD 123.00
Kilitsiz/Without lock 12
cm



BARRAQUER
BM 130.00-BM 131.00
Kilitsiz/Without lock



1/2
FD 124.00-FD 125.00
Kilitli/With lock
15 cm



1/2
REILL
FD 126.00-FD 127.00
Kilitsiz/Without lock 15 cm

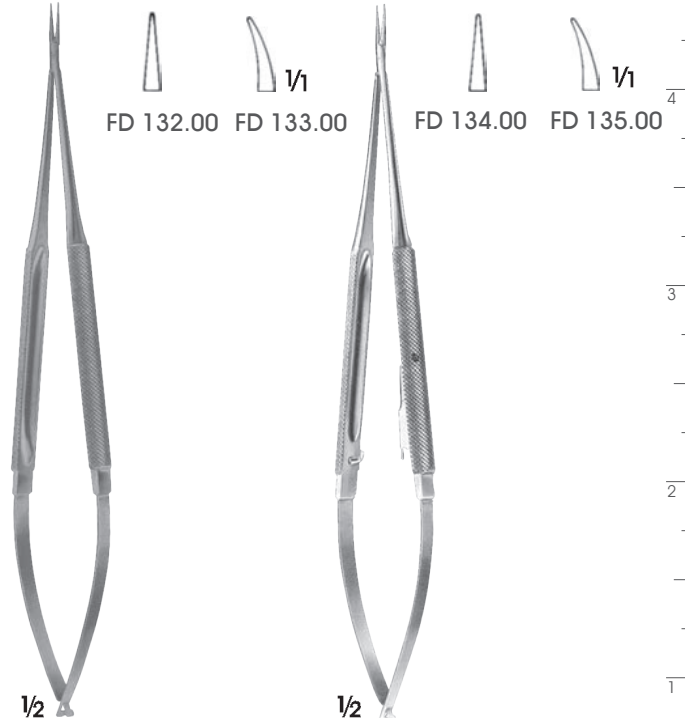

1/2
FD 132.00-FD 133.00
Kilitsiz/Without lock 18.5
cm

1/2
FD 134.00-FD 135.00
Kilitli/ With catch 18.5 cm



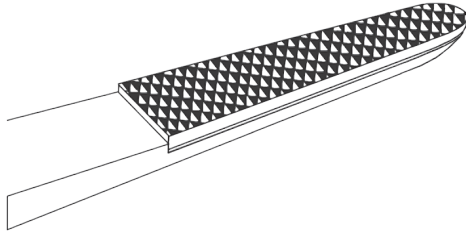

Elmas Uclu Portegüler :

ARGENT Portegülerinin ağızlarındaki elmas uçlarının kullanıma göre yüzey yapısı seçilebilir.

ARGENT elmas uclu portegülerinin 4 farklı yüzeyi vardır. Pürüzsüz yüzey ve 3 farklı çentik yüzeyi uygun iğne yakalamayı sağlar.

Needle holders with carbide inserts.

The carbide inserts on ARGENT needle holders can be selected based on usage.

ARGENT needle holders with carbide inserts have four different surface types. Smooth surface and three different notched surfaces provide appropriate needle catch.



Düz
smooth

Pürüzsüz yüzeye sahip ağızlarda kullanılacak, dikiş malzemesi için: 9/0 - 11/0

With smooth jaw surface for suture materials: 9/0 - 11/0



0,2

0.2 mm adımlı çentiğe sahip ağızda kullanılacak, dikiş malzemesi için: 6/0 - 10/0

With 0.2 mm pitch of serration for suture material: 6/0 - 10/0



0,4

0.4 mm adımlı çentiğe sahip ağızda kullanılacak, dikiş malzemesi için: 4/0 - 6/0

0.4 mm pitch of serration for suture material: 4/0 - 6/0



0,5

0.5 mm adımlı çentiğe sahip ağızda kullanılacak, dikiş malzemesi için: 3/0' a kadar

0.5 mm pitch of serration for suture material: up to 3/0



$\frac{1}{1}$
Düz ağız
With smooth jaw

$\frac{1}{2}$
CASTROVIEJO
BM 301.00
Kilitli/With lock
14.5 cm



$\frac{1}{1}$
0,2

$\frac{1}{2}$
CASTROVIEJO
BM 303.00
Kilitli/With lock
14.5 cm



$\frac{1}{1}$
0,4

$\frac{1}{2}$
F 312.00
Kilitli/With lock
17 cm



0,2
F 305.00
18 cm

CASTROVIEJO
BM 305.00-BM 305.01
Kilitli/With lock



$\frac{1}{1}$
0,2

F 305.01
21.5 cm



$\frac{1}{1}$
0,2

$\frac{1}{2}$
FM 308.00
Kilitli/With lock
18 cm



$\frac{1}{1}$
0,2

$\frac{1}{2}$
FM 308.01
Kilitli/With lock
20 cm

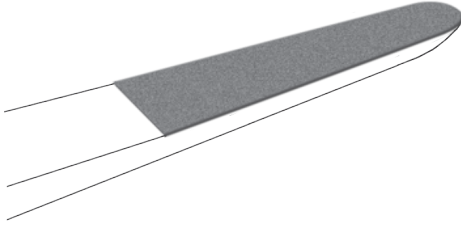

DIAMOTE ağızlar, daha sert ve aşınmaya dayanıklı yüzeyler sağlar.
DIAMOTE ağızlar, hassas iğne, suture ve dokuların güvenilir bir şekilde kavranmasını garanti eder.

DIAMOTE jaws provide harder and more wear resistant surfaces.
DIAMOTE jaws ensure reliable grip of fine needles, sutures and tissues.



BM 307.00

BM 307.04

1/2

BM 307.00-BM 307.04
Kilitli/With lock
18 cm



1/1

Suture 5-0 ve daha küçükler için
For sutures 5-0 and smaller

1/2

FM 310.36
Kilitli/With lock
21 cm



1/1

Suture 5-0 ve daha küçükler için
For sutures 5-0 and smaller

1/2

FM 310.37 Kilitli/
Without lock 21
cm



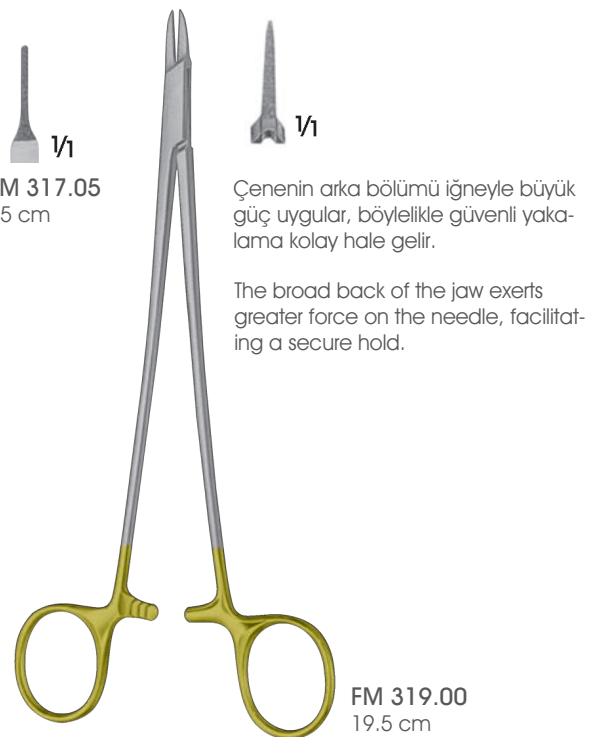
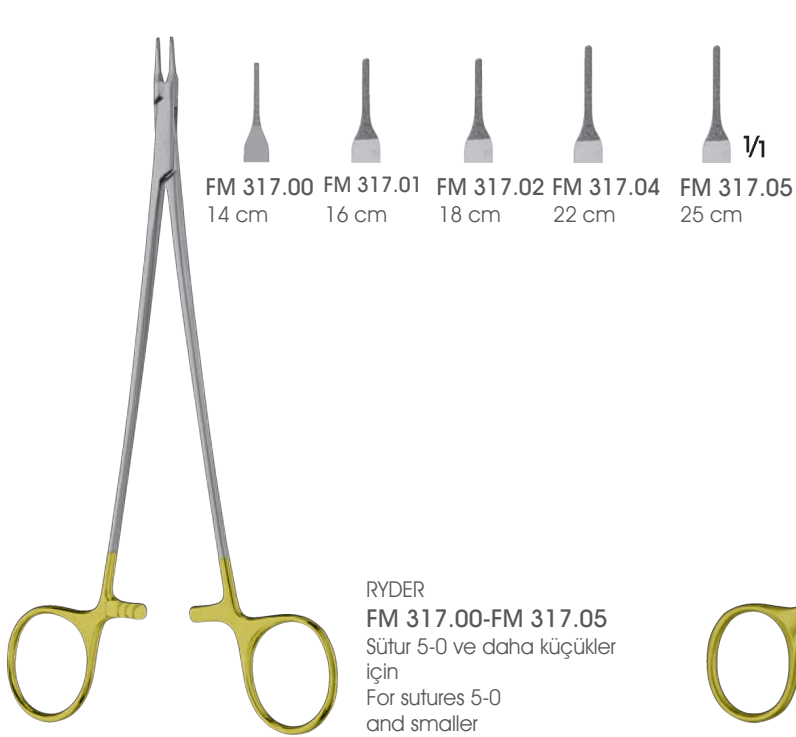



Sütür 7-0 ve daha
küçükler için
For sutures 7-0
and smaller

18.5 cm FM 312.01T
21 cm FM 312.02T
23 cm FM 312.04T
Kilitli/With lock

18.5 cm FM 312.11T
21 cm FM 312.12T
23 cm FM 312.14T
Kilitsiz/Without lock



Sütür 5-0 ve daha
küçükler için
For sutures 5-0
and smaller

18.5 cm FM 312.21T
21 cm FM 312.22T
23 cm FM 312.24T
Kilitli/With lock

18.5 cm FM 312.31T
21 cm FM 312.32T
23 cm FM 312.34T
Kilitsiz/Without lock



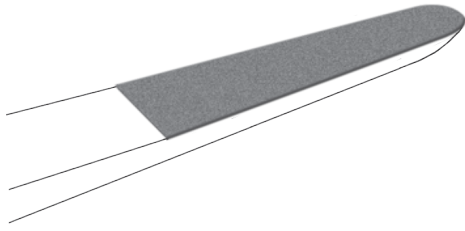

DIAMOTE ağızlar, daha sert ve aşınmaya dayanıklı yüzeyler sağlar.
DIAMOTE ağızlar, hassas iğne, suture ve dokuların güvenilir bir şekilde kavranmasını garanti eder.

DIAMOTE jaws provide harder and more wear resistant surfaces.
DIAMOTE jaws ensure reliable grip of fine needles, sutures and tissues.

Suture 7-0 ve daha
küçükler için
For sutures 7-0
and smaller

Suture 5-0 ve daha
küçükler için
For sutures 5-0
and smaller

Suture 7-0 ve daha
küçükler için
For sutures 7-0
and smaller

Suture 5-0 ve daha
küçükler için
For sutures 5-0
and smaller

Suture 4-0 ve daha
küçükler için
For sutures 4-0
and smaller

Suture 4-0 ve daha
küçükler için
For sutures 4-0
and smaller



12 cm	FM 310.01	-
14.5 cm	-	FM 310.06
16 cm	FM 310.02	FM 310.07
18.5 cm	FM 310.03	FM 310.08
21 cm	FM 310.04	FM 310.09
23 cm	FM 310.05	FM 310.10

FM 310.01-FM 310.10
Kilitsiz/Without lock



12 cm	FM 310.21	-
14.5 cm	-	FM 310.26
16 cm	FM 310.22	FM 310.27
18.5 cm	FM 310.23	FM 310.28
21 cm	FM 310.24	FM 310.29
23 cm	FM 310.25	FM 310.30

FM 310.21-FM 310.35
Kilimli/With lock

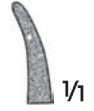

-	-	-
-	-	-
-	-	-
FM 310.31	-	-
FM 310.32	-	FM 310.34
FM 310.33	-	FM 310.35

Suture 2-0 ve daha
küçükler için
For sutures 2-0
and smaller



19 cm	FM 310.44
23 cm	FM 310.46
25 cm	FM 310.48

FM 310.44-FM 310.48
Kilitsiz/Without lock



Suture 2-0 ve daha
küçükler için
For sutures 2-0
and smaller

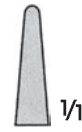

19 cm	FM 310.45
23 cm	FM 310.47
25 cm	FM 310.49

FM 310.45-FM 310.49
Kilimli/With lock



Düz Sap/Flat Handle

Sütür 7-0 ve daha
küçükler için
For sutures 7-0
and smaller

Sütür 5-0 ve daha
küçükler için
For sutures 5-0
and smaller

Sütür 7-0 ve daha
küçükler için
For sutures 7-0
and smaller

Sütür 5-0 ve daha
küçükler için
For sutures 5-0
and smaller



FM 311.02-FM 311.06
Kilitsiz/Without lock

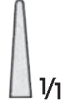

14.5 cm	-	FM 311.03
17 cm	FM 311.02	-
18.5 cm	-	FM 311.04
21 cm	-	FM 311.05
23 cm	-	FM 311.06



FM 311.12-FM 311.16
Kilitti/With lock



14.5 mm	-	FM 311.13
17 cm	FM 311.12	-
18.5 cm	-	FM 311.14
21 cm	-	FM 311.15
23 cm	-	FM 311.16

Kanallı Düz Sap/Flat Knurled Handle

Sütür 5-0 ve daha
küçükler için
For sutures 5-0
and smaller

Sütür 5-0 ve daha
küçükler için
For sutures 5-0
and smaller



FM 311.20-FM 311.22
Kilitsiz/Without lock



18.5 cm	FM 311.20
21 cm	FM 311.21
23 cm	FM 311.22



FM 311.25-FM 311.27
Kilitti/With lock



18.5 cm	FM 311.25
21 cm	FM 311.26
23 cm	FM 311.27



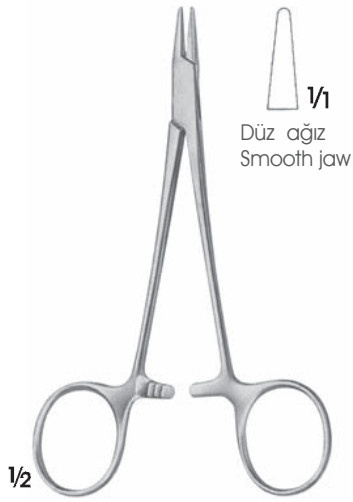

Düz ağız
Smooth jaw

1/2

WEBSTER
BM 200.00
12.5 cm



1/1

1/2

CONVERSE
BM 202.00
13 cm



1/1

BM 203.00 BM 204.00

Düz ağız
Smooth jaws

1/2

HALSEY
BM 203.00-BM 204.00
13 cm

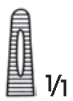

1/1

1/2

DERF
BM 206.00
12.5 cm



1/1

1/2

BAUMGARTNER
BM 210.00
14.5 cm

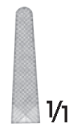

1/1

Hassas ağız
Delicate jaw

1/2

LAWRANCE
BM 211.00
15 cm



DOYEN
BM 207.00
12.5 cm



CRILE-WOOD
BM 215.00
15 cm

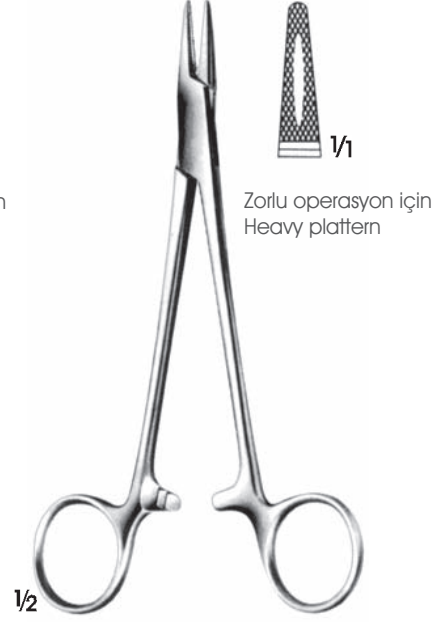

CRILE-WOOD
BM 217.00
16 cm



KILNER
BM 221.00
13.5 cm

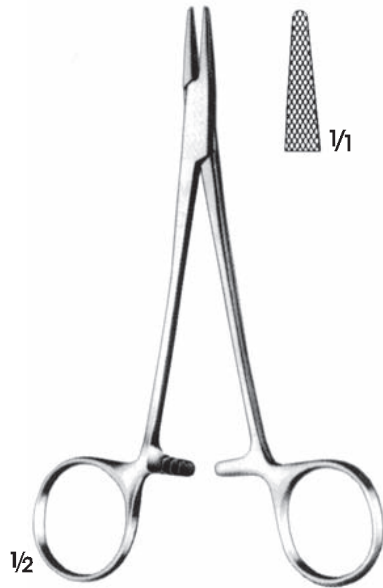

CRILE-MURRAY
BM 219.00
15 cm



MAYO-HEGAR
BM 223.01-BM 223.03





MAYO-HEGAR
BM 230.00-BM 230.04
Orta incelikte dikiş pensu
Medium fine patterns

HEGAR
BM 231.00-BM 232.00
Zorlu operasyon için Heavy
patterns

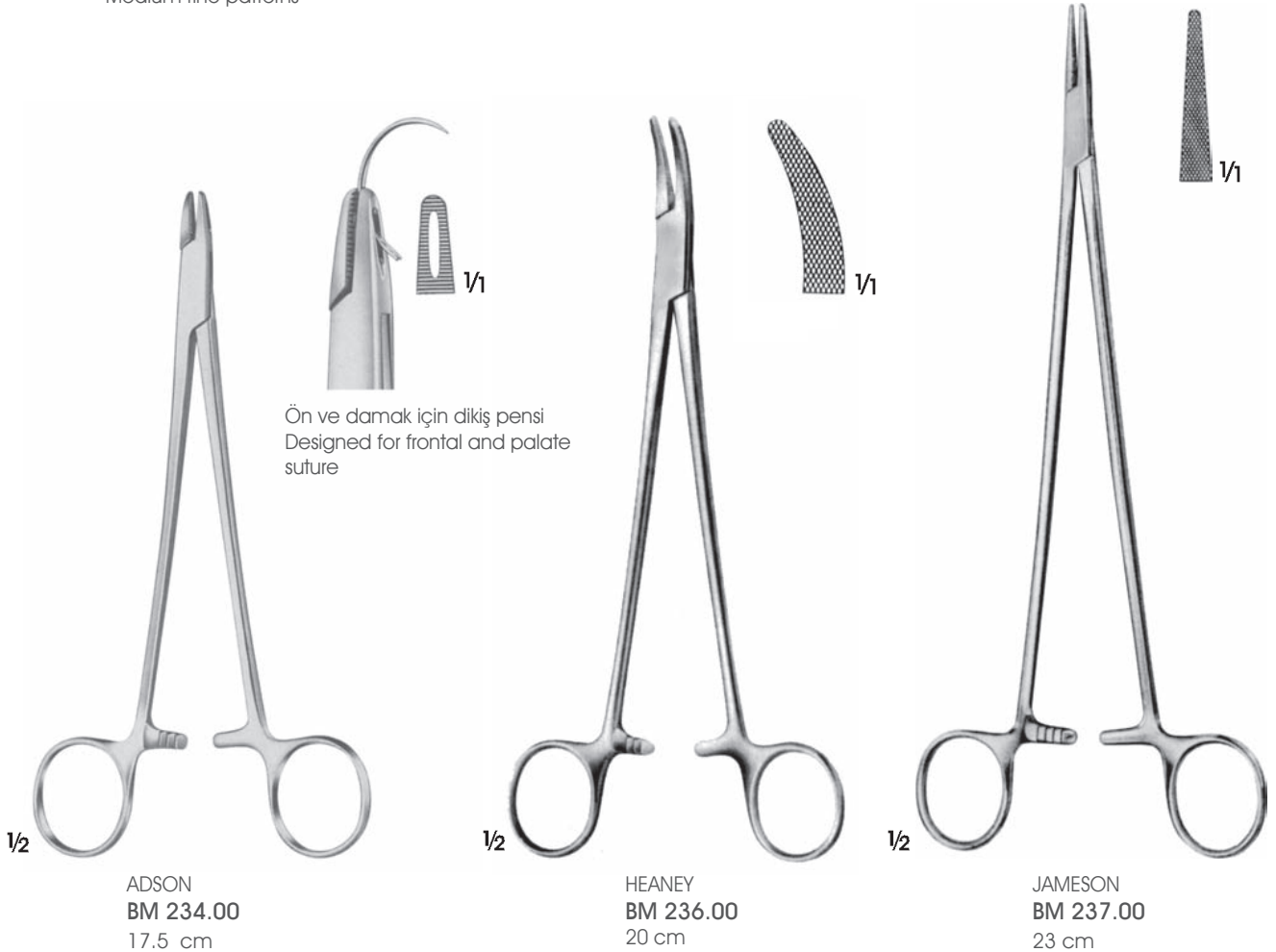

Ön ve damak için dikiş pensu
Designed for frontal and palate
suture

ADSON
BM 234.00
17.5 cm

HEANEY
BM 236.00
20 cm

JAMESON
BM 237.00
23 cm

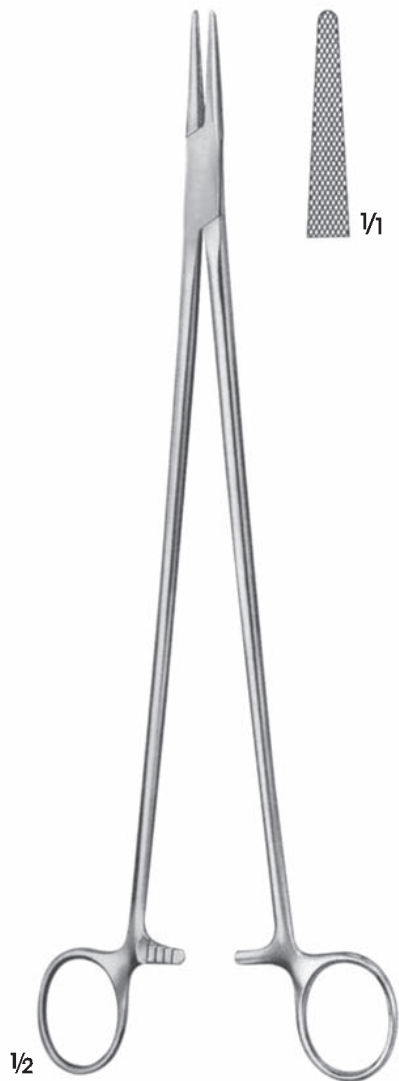
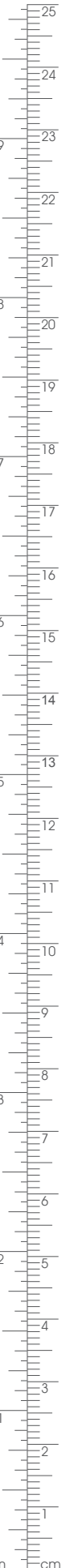

WANGENSTEEN
BM 238.00
27.5 cm



MASSON
BM 239.00
26.5 cm

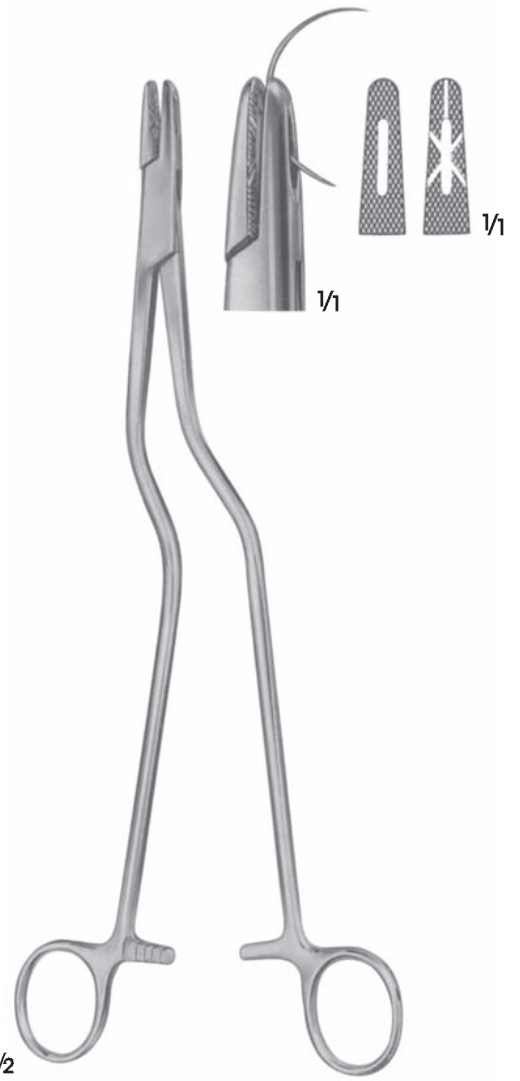

MASSON-LUETHY
BM 240.00
25.5 cm



HEGAR-OLSEN
BM 260.00-BM 261.00



BM 260.00
14 cm

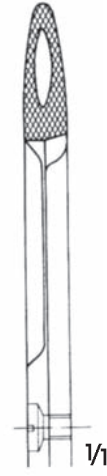

BM 261.00
18.5 cm



GILLIES
BM 268.00
15 cm



GILLIES
BM 269.00
16 cm

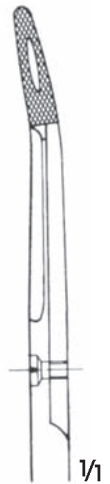
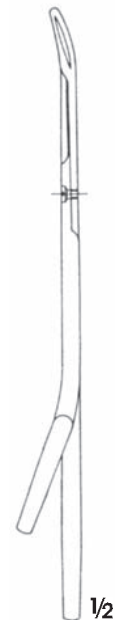



$\frac{1}{2}$
CRILE
BM 250.00
15 cm



$\frac{1}{2}$
TÖNNIS
BM 251.00
Dura ve bağırsak dikiş pensi
Elastic pattern for dura-or intestinal suture
18 cm

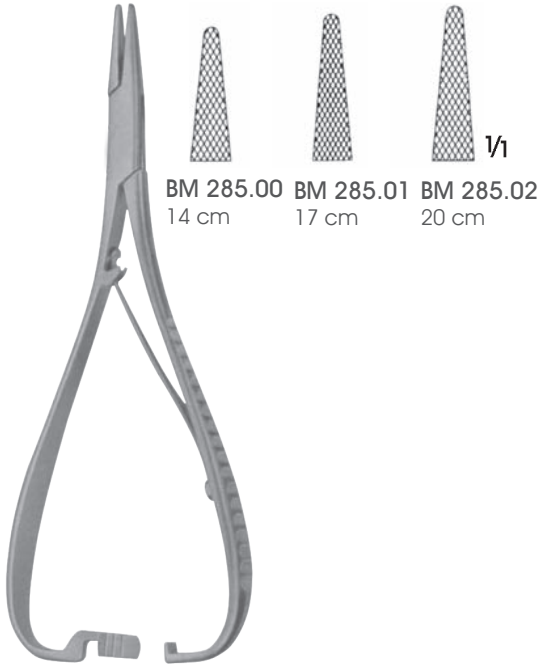

MATHIEU
BM 285.00-BM 285.02

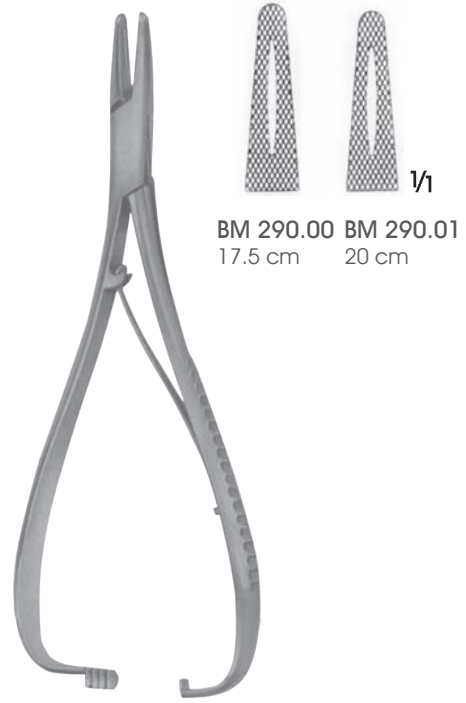

MATHIEU -STILLE
BM 290.00-BM 290.01
Çok zorlu operasyon için Very
heavy patterns



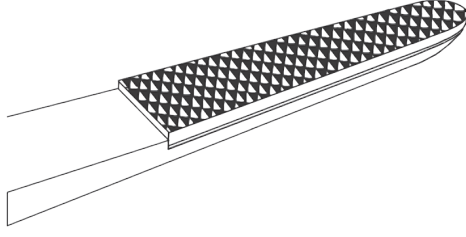

Elmas Uclu Portegüler :

ARGENT Portegülerinin ağızlarındaki elmas uclarının kullanıma göre yüzey yapısı seçilebilir.

ARGENT elmas uclu portegülerinin 4 farklı yüzeyi vardır. Pürüzsüz yüzey ve 3 farklı çentik yüzeyi uygun iğne yakalamayı sağlar.

Needle holders with carbide inserts.

The carbide inserts on ARGENT needle holders can be selected based on usage.

ARGENT needle holders with carbide inserts have four different surface types. Smooth surface and three different notched surfaces provide appropriate needle catch.



Düz
smooth

Pürüzsüz yüzeye sahip ağızlarda kullanılacak, dikiş malzemesi için: 9/0 - 11/0

With smooth jaw surface for suture materials: 9/0 - 11/0



0,2

0.2 mm adımlı çentiğe sahip ağızda kullanılacak, dikiş malzemesi için: 6/0 - 10/0

With 0.2 mm pitch of serration for suture material: 6/0 - 10/0



0,4

0.4 mm adımlı çentiğe sahip ağızda kullanılacak, dikiş malzemesi için: 4/0 - 6/0

0.4 mm pitch of serration for suture material: 4/0 - 6/0



0,5

0.5 mm adımlı çentiğe sahip ağızda kullanılacak, dikiş malzemesi için: 3/0' a kadar

0.5 mm pitch of serration for suture material: up to 3/0



Düz ağız
With smooth jaw

HALSEY
BM 320.00
12 cm



Düz ağız
With smooth jaws

WEBSTER
BM 321.00
12.5 cm



0,4

MASING
BM 322.00
Tek ayağı açılı, yüzüklü
One ring angled
13 cm

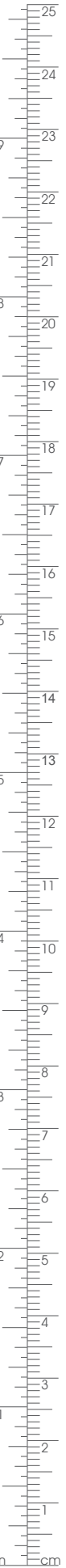
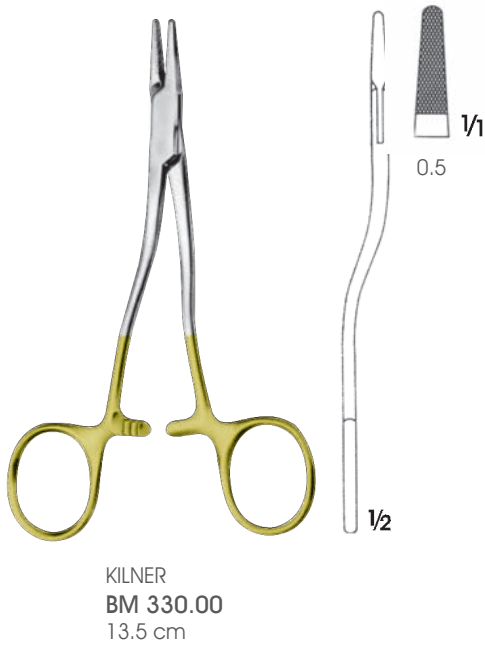
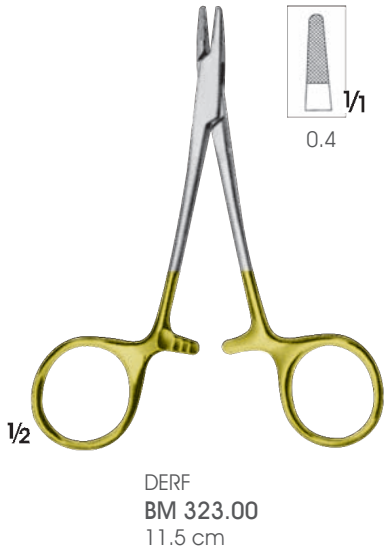



CRILE-WOOD
BM 333.00-BM 333.05

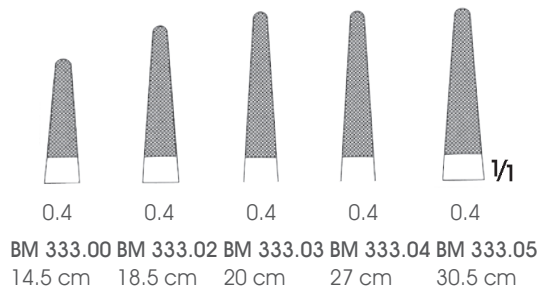

SAROT
BM 338.00-BM 338.05

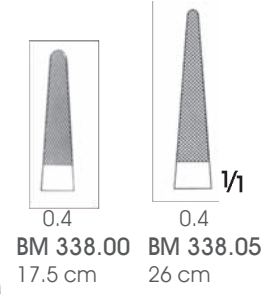

DE BAKEY
BM 344.00-BM 345.01
Çok hassas/Very delicate

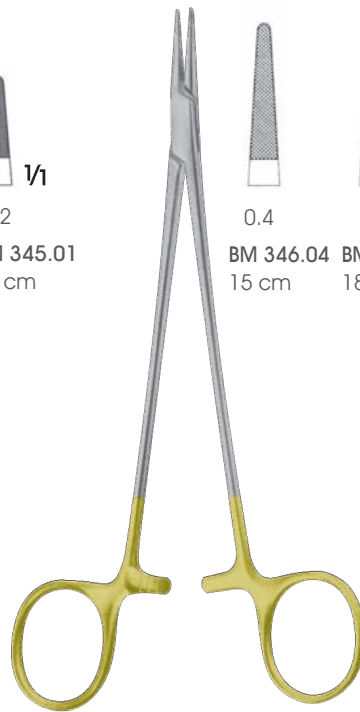
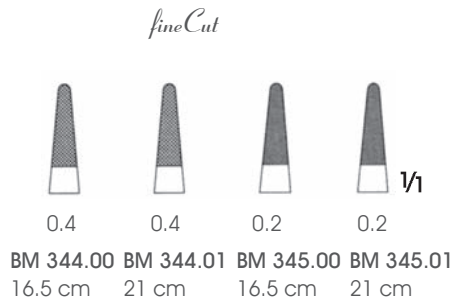

DE BAKEY
BM 346.00-BM 346.04

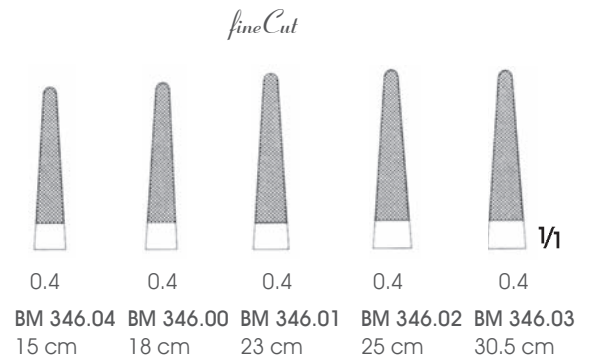

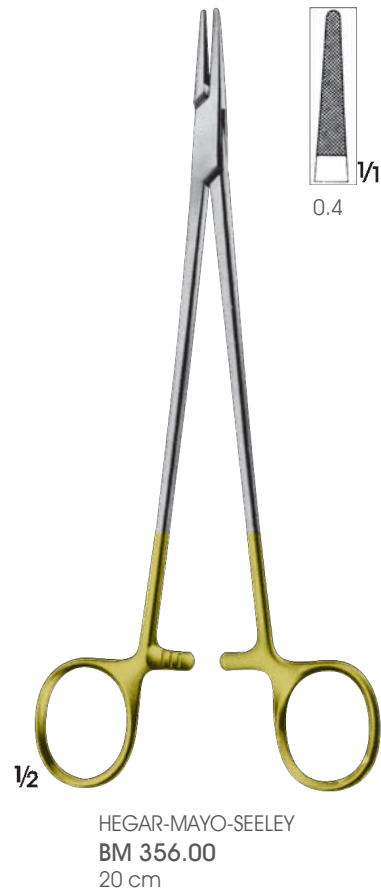
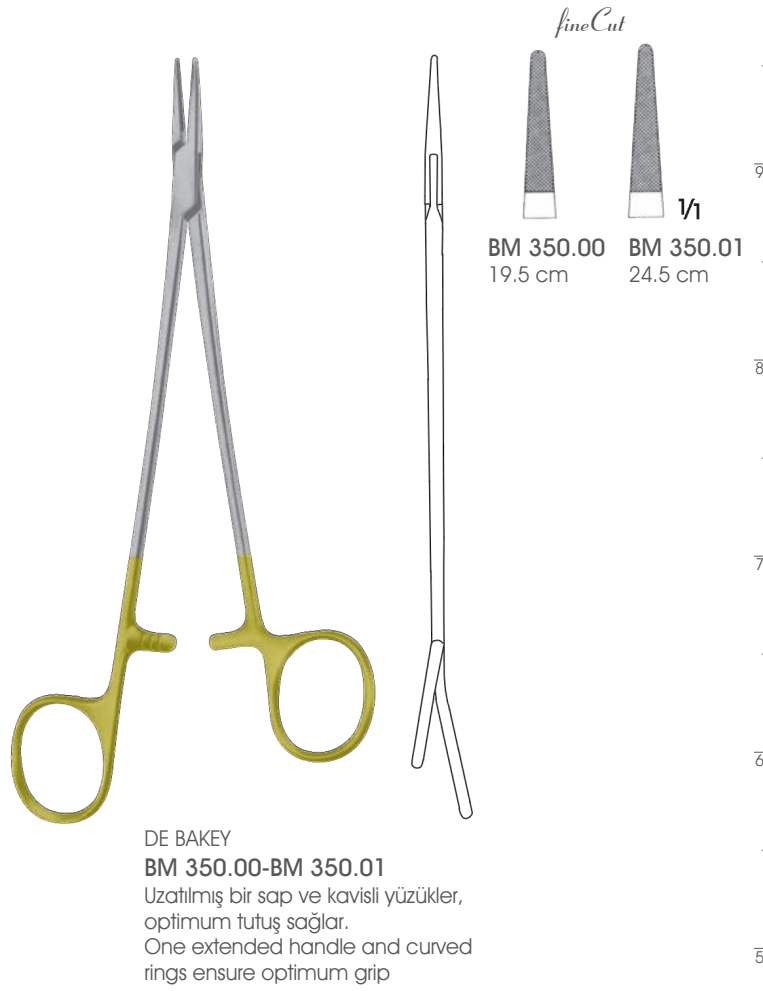
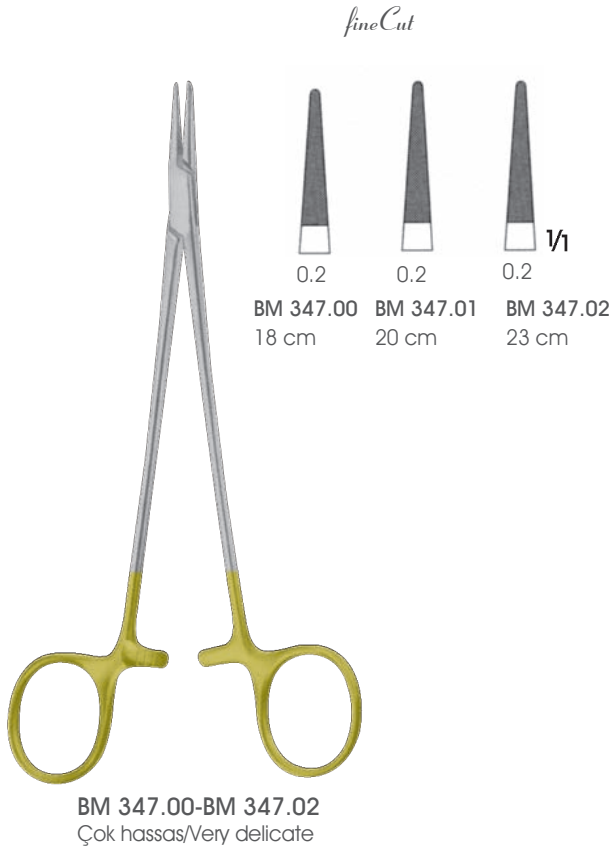

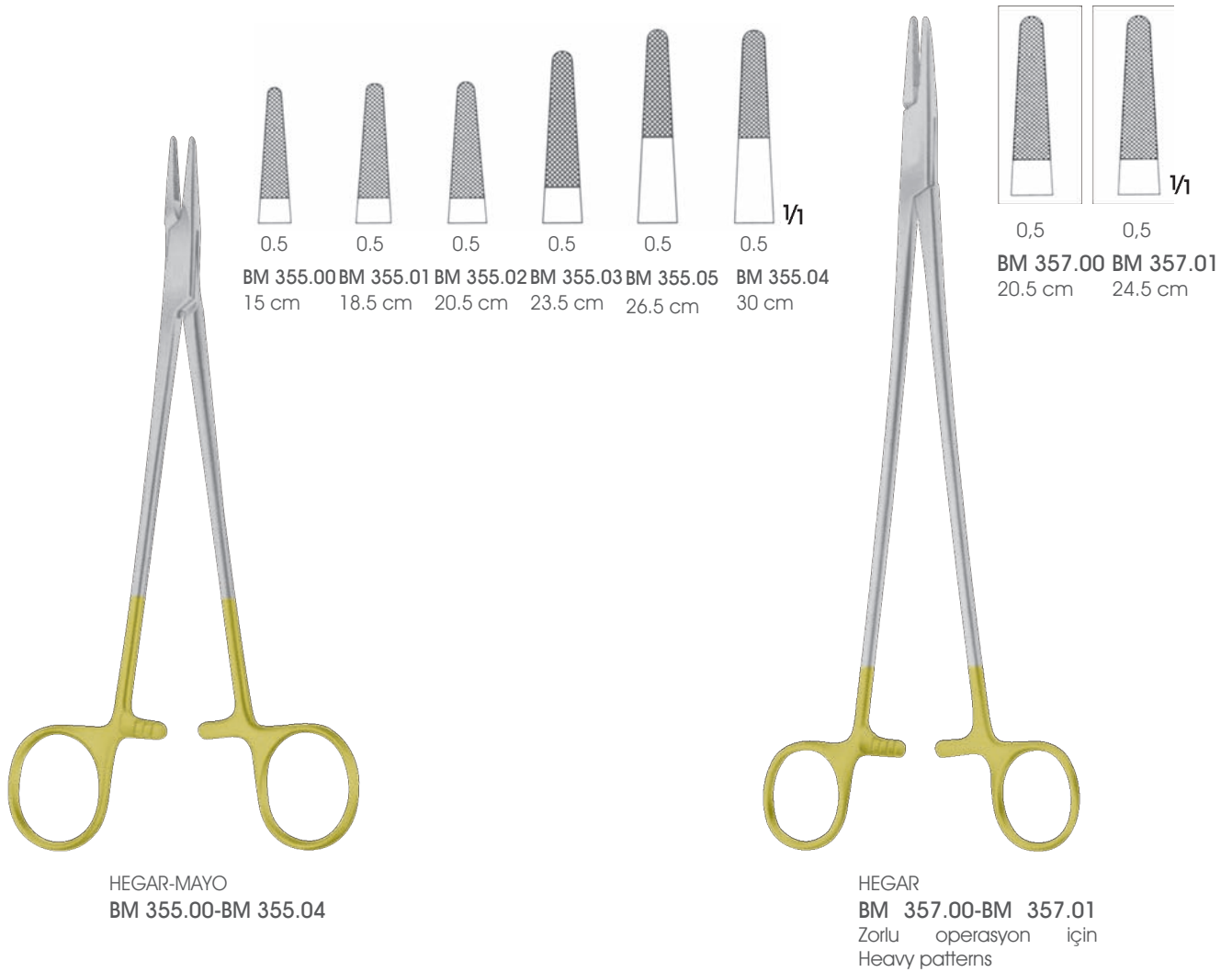

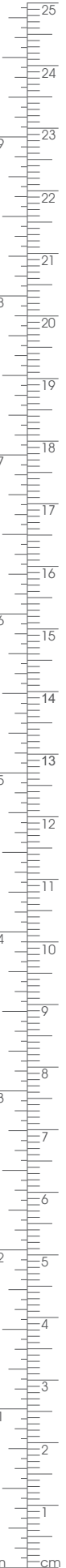
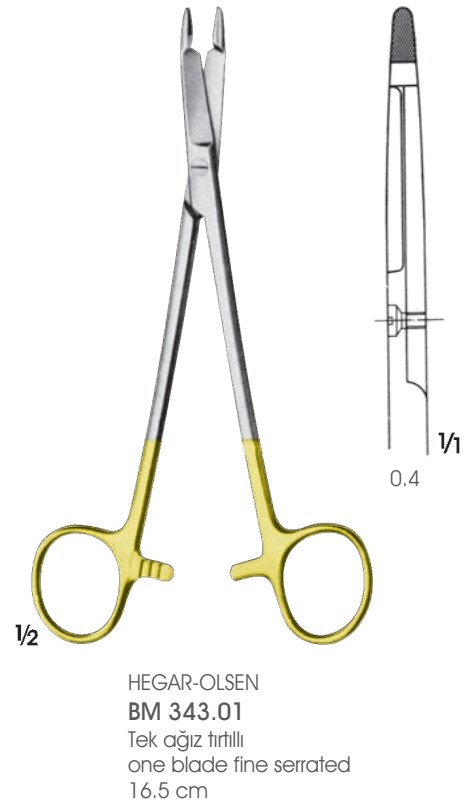
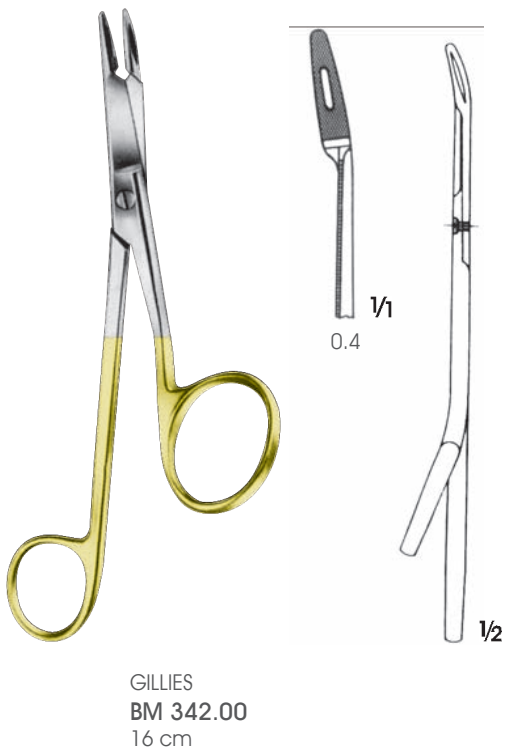

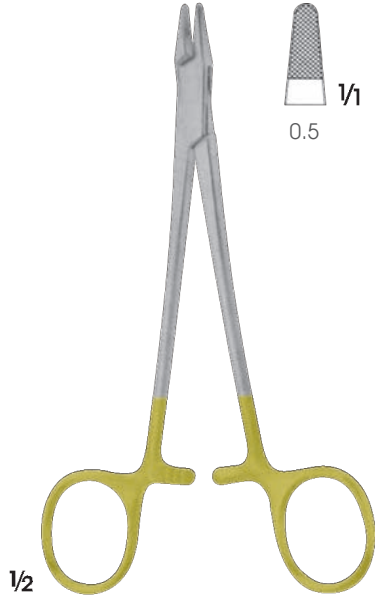

BM 334.00
Tel bükücü/Wire twister
15 cm



BM 336.00
Tel bükücü/Wire twister
15 cm

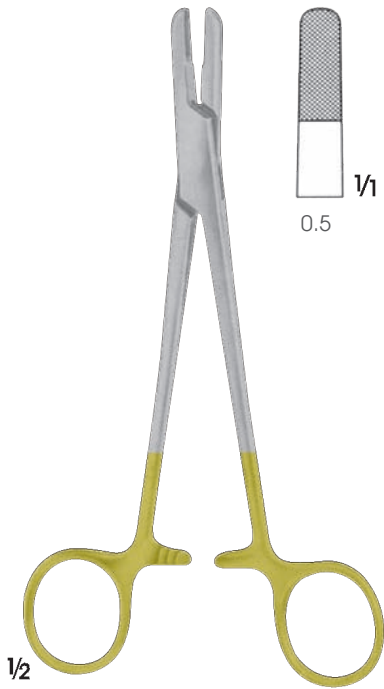

BM 337.01
Tel Bükücü/ Wire twister
Sternum suture için ligatür pens
Sternum suture for ligature forceps
17.5 cm



BERRY MD 335.00
Tel bükücü/Wire twister
Ligatür pens/Ligature forceps
18.5 cm



BAUMGARTNER BM 339.01
Tel bükücü/Wire twister
Ligatür pens/Ligature forceps
20 cm

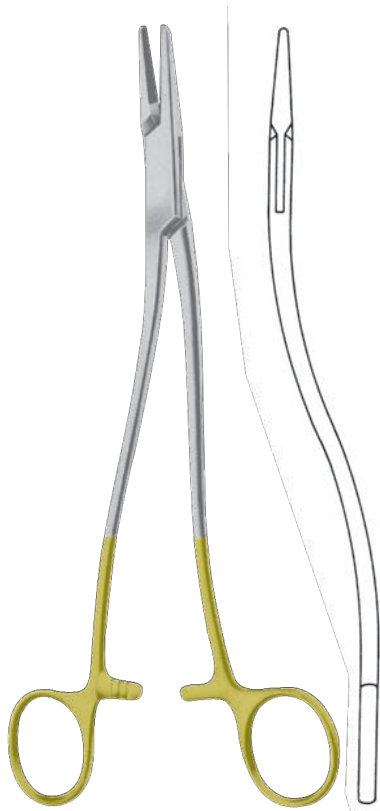

WERTHEIM
 BM 370.00-BM 370.02



0.5
BM 370.00
 20 cm



0.5
BM 370.01
 24 cm

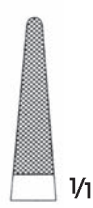

0.5
BM 370.02
 30 cm



HEANEY
 BM 373.00-BM 373.02



0.5
BM 373.00
 20 cm

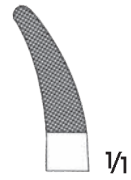

0.5
BM 373.02
 26 cm

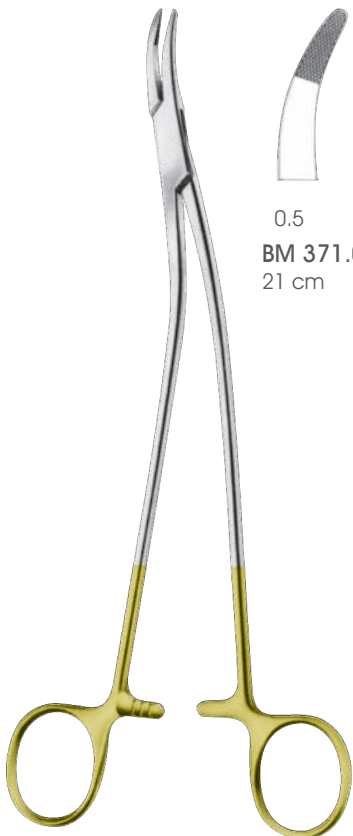

STRATTE
 BM 371.00-BM 371.01



0.5
BM 371.00
 21 cm



0.5
BM 371.01
 23 cm



BM 374.00
 S şekli portegü/S-shaped needle
 21.5 cm



0.5
 $\frac{1}{2}$

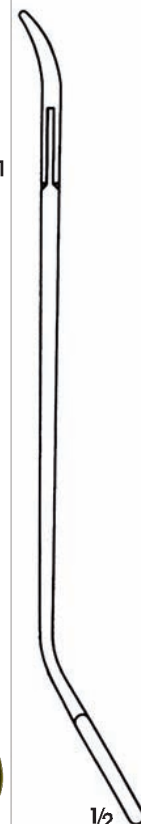

$\frac{1}{2}$

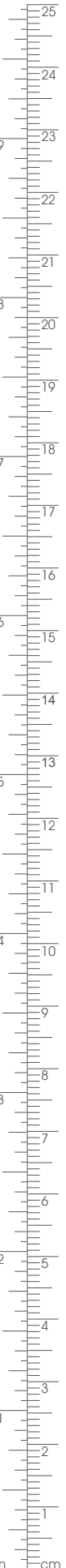

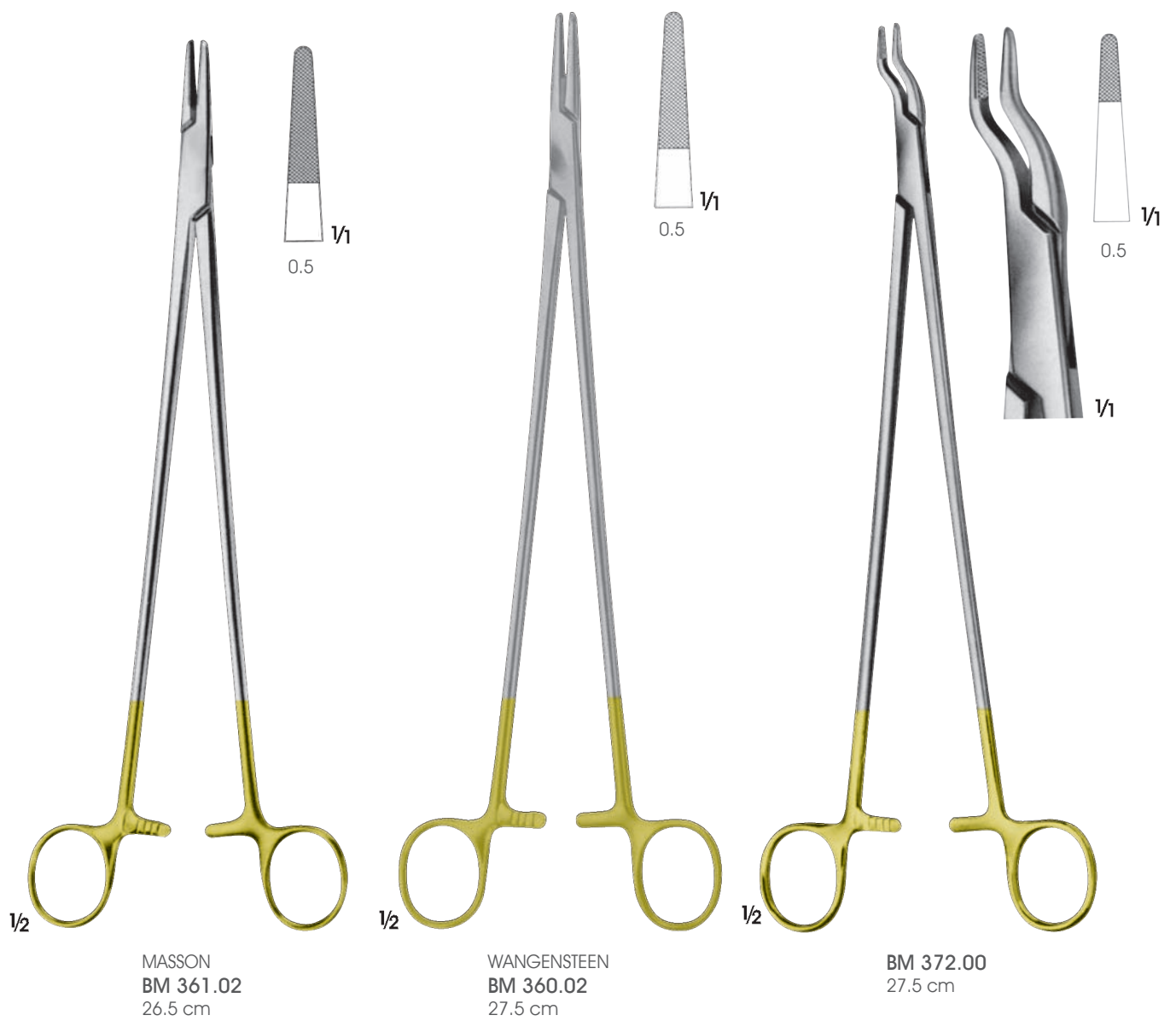



$\frac{1}{2}$
 FINOCHIETTO
 BM 363.02
 26.5 cm



$\frac{1}{2}$
 NAUNTON-MORGAN
 BM 353.00
 26 cm



$\frac{1}{2}$
 MÜLLER
 BM 354.00
 Derin rektum cerrahisi için
 For deep rectum surgery
 36 cm

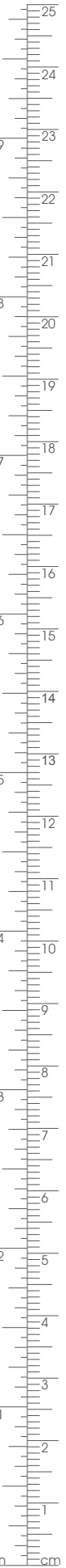

- Hassas çeneler travmatik olmayan ve hassas damar iğnelerini tutmak için uygundur.

- Fine jaws are suitable for gripping non-traumatic needles and vein needles.

fineCut



0.2

BM 380.00
13.5 cm



0.2

BM 380.01
15.5 cm



0.2

BM 380.02
17.5 cm



0.2

BM 380.03
21 cm



0.2

BM 380.04
23 cm

RYDER

BM 380.00-BM 380.04

Çok hassas/Very delicate



0.4

BM 381.00
13.5 cm



0.4

BM 381.01
17.5 cm



0.4

BM 381.02
19.5 cm



0.4

BM 381.03
26.5 cm

RYDER

BM 381.00-BM 381.03



RYDER
 BM 324.00-BM 324.03
 Düz ağız/With smooth jaws



BM 324.00
 15 cm



BM 324.01
 18 cm



BM 324.03
 23 cm $\frac{1}{1}$



$\frac{1}{2}$
 BM 385.01
 18 cm



$\frac{1}{1}$
 0.4



$\frac{1}{2}$
 BM 385.00
 20 cm



$\frac{1}{1}$
 0.4

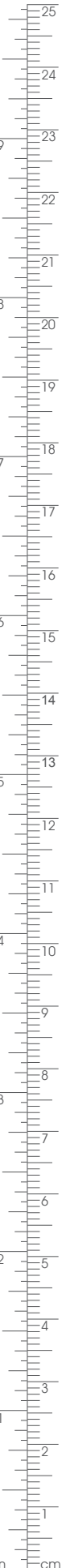

- Cerraha maksimum ergonomik rahatlık sağlar.
- Optimize tasarımları sayesinde zor suture ve anastomoz tekniklerinde yorulmadan çalışmayı sağlar.
- Provides maximum ergonomic comfort to surgeon.
- Due to optimized design, it provides fatigue free working on suture and anastomosis techniques.



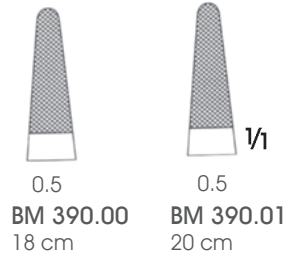

LANGENBECK
 BM 390.00-BM 390.01

fineCut



LANGENBECK
 BM 391.00
 Elastik model/Elastic pattern
 20 cm



TÖNNIS
 BM 387.00
 Elastik model/Elastic pattern
 18 cm



TÖNNIS
 BM 384.00
 Elastik model/Elastic pattern
 18 cm

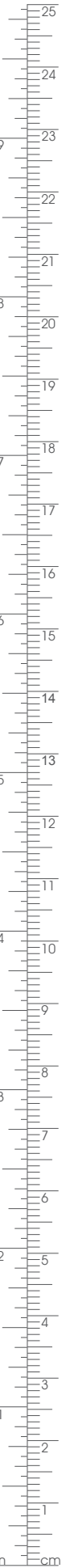

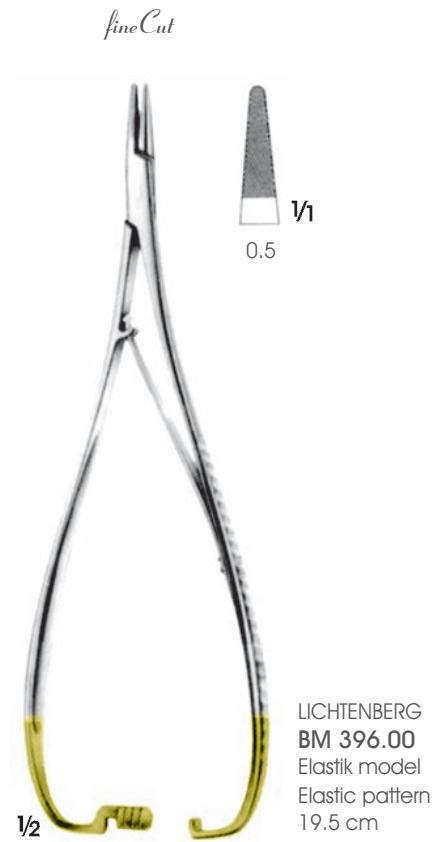
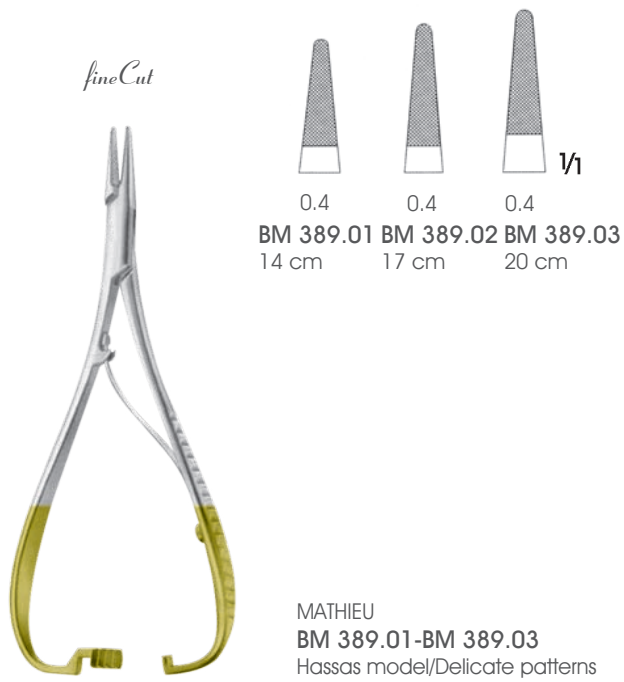

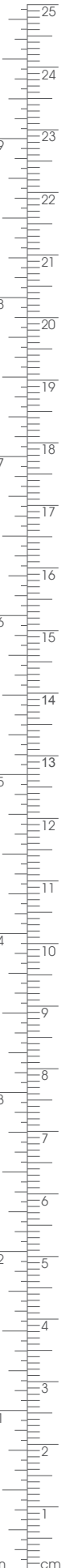
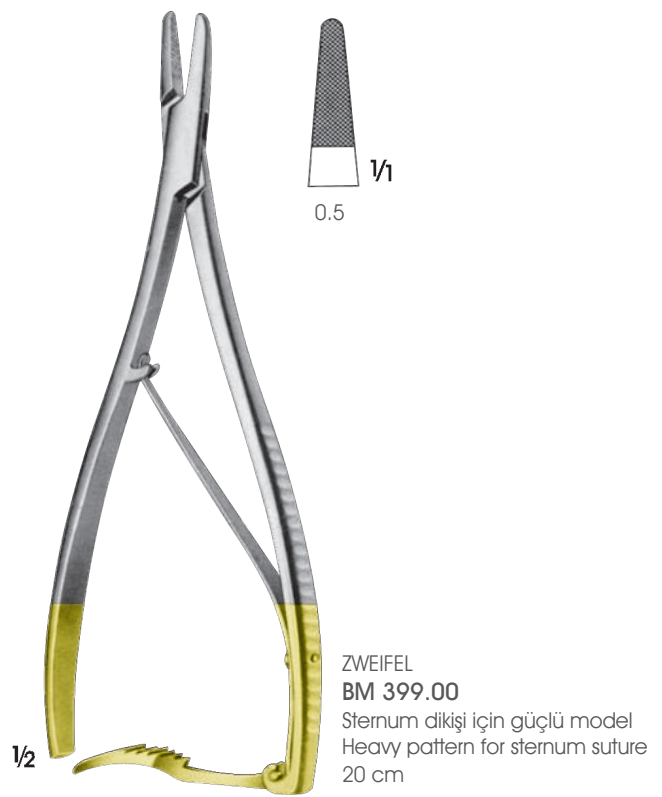



1/2

YOUNG-HRYNTSCHAK
BM 406.00
1 iğne ile F 400.00
With 1 needle F 400.00
24 cm



1/1

BM 400.00



1/1

BM 400.01



1/1

BM 400.02



1/2

MILLIN
EF 408.00
Ligatur tutucu pens
Ligature holding forceps
28.5 cm

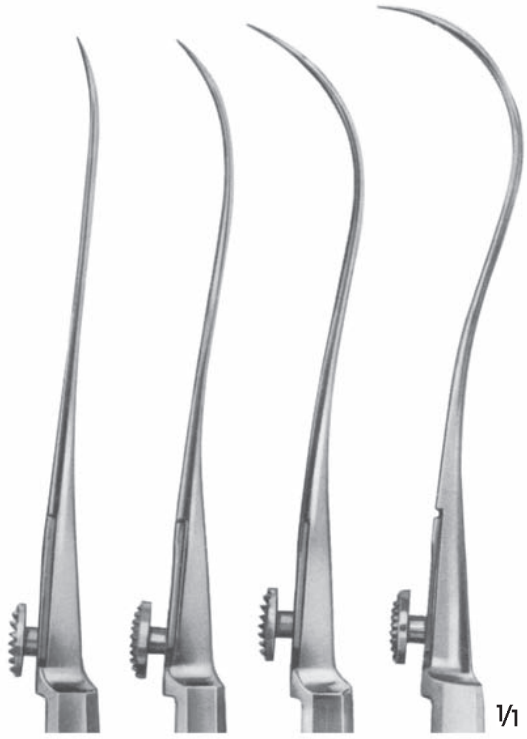

BM 411.00 BM 411.01 BM 411.02 BM 411.03



BM 412.00 BM 412.01 BM 412.02 BM 412.03

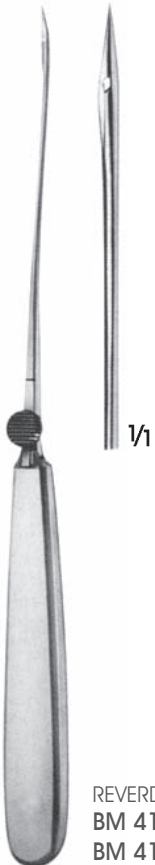

REVERDIN
BM 411.00-BM 411.03 19,5 cm
BM 412.00-BM 412.03 22 cm





KRONECKER
BM 420.00
Sağ el için, künt For
right hand blunt
BM 421.00
Sol el için, künt For
left hand blunt 15.5
cm

DESCHAMPS
BM 422.00
Sağ el için, sivri For
right hand sharp
BM 423.00
Sol el için, künt
For left hand sharp
21 cm

HURD
BM 424.00
Sağ el için, sivri
For right hand sharp
BM 425.00
Sol el için, künt
For left hand sharp
21 cm



1/1
BM 428.00

1/2

DESCHAMPS
BM 428.00
Sağ el için, künt
For right hand blunt
BM 429.00
Sol el için, künt
For left hand blunt
22.5 cm



1/1
BM 429.00

1/2



1/1
BM 430.00

1/2

DESCHAMPS
BM 430.00
Sağ el için, künt
For right hand blunt
BM 431.00
Sol el için, künt
For left hand blunt
22.5 cm



1/1
BM 431.00

1/2



1/1
BM 432.00

1/2

DESCHAMPS
BM 432.00
Sağ el için, künt
For right hand blunt
BM 433.00
Sol el için, künt
For left hand blunt
21.5 cm



1/1
BM 433.00

1/2



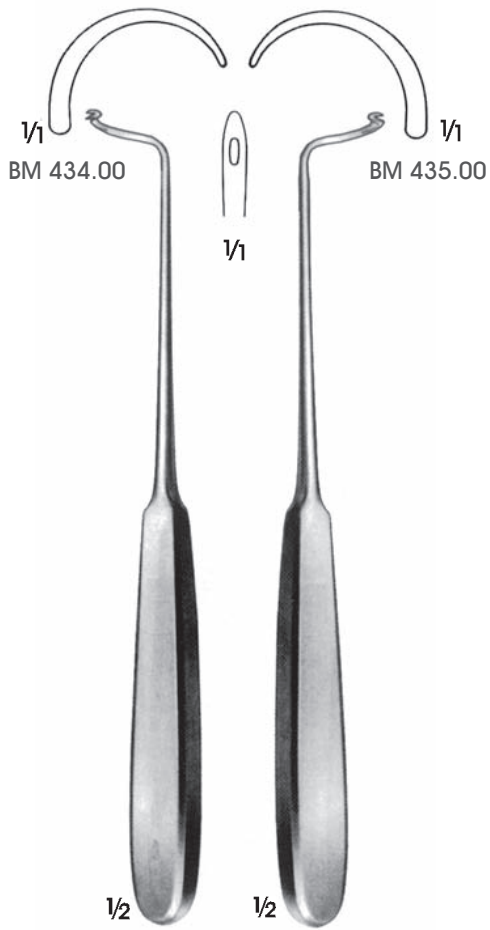

DESCHAMPS
BM 434.00
Sağ el için, künt
For right hand blunt
BM 435.00
Sol el için, künt
For left hand blunt
21 cm

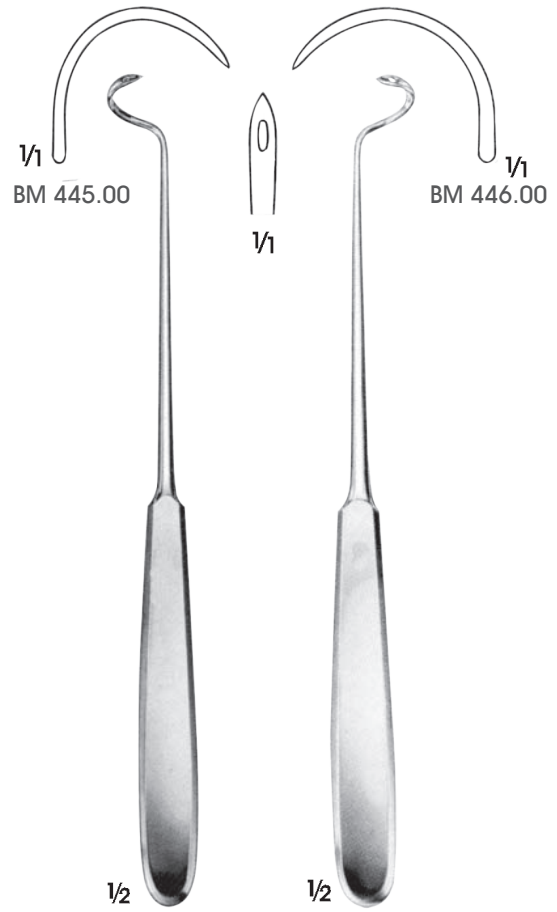

DESCHAMPS
BM 445.00
Sağ el için, künt For
right hand blunt
BM 446.00
Sol el için, künt
For left hand blunt
21.5 cm

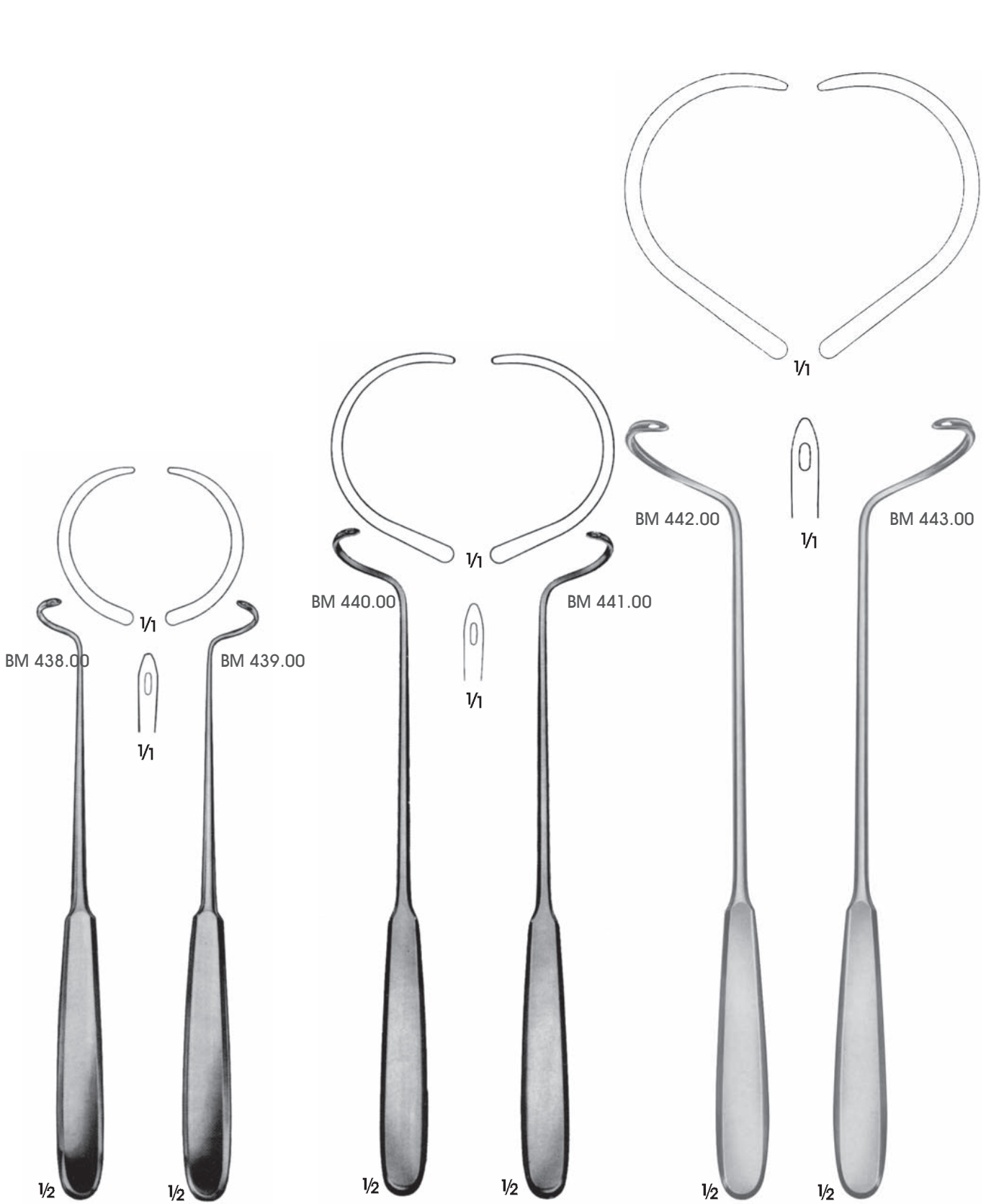

DESCHAMPS
BM 438.00
Sağ el için, künt
For right hand blunt
BM 439.00
Sol el için, künt
For left hand blunt
21.5 cm

DESCHAMPS
BM 440.00
Sağ el için, künt
For right hand blunt
BM 441.00
Sol el için, künt
For left hand blunt
24 cm

DESCHAMPS
BM 442.00
Sağ el için, künt For
right hand blunt
BM 443.00
Sol el için, künt For
left hand blunt 28
cm

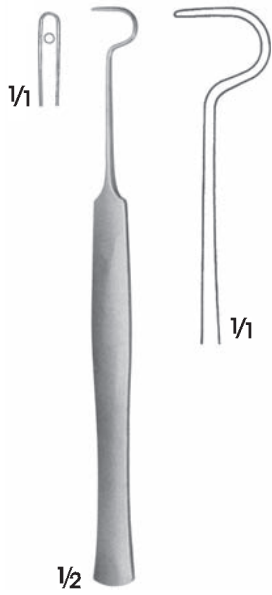

BM 450.00
15 cm

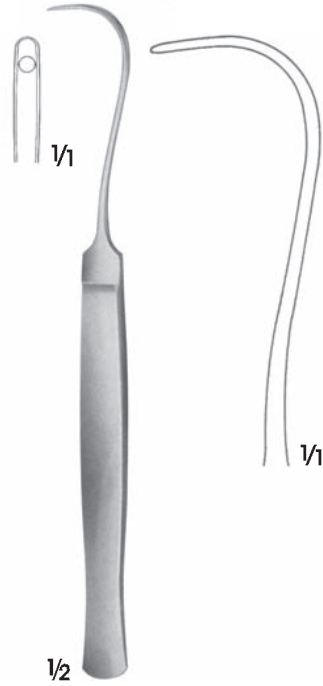

SYME
BM 454.00
17 cm



JONESCO
BM 453.00
Dikiş teli Klavuzu
Needle for wire suture
18.5 cm

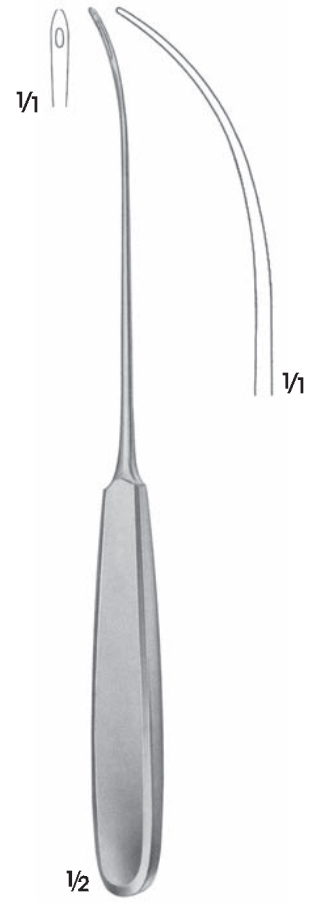

BM 460.00
Bükülebilir/Malleable
23 cm



CLAUS VAN EICKEN
BM 451.00
25 cm



COOPER
BM 455.00
20.5 cm

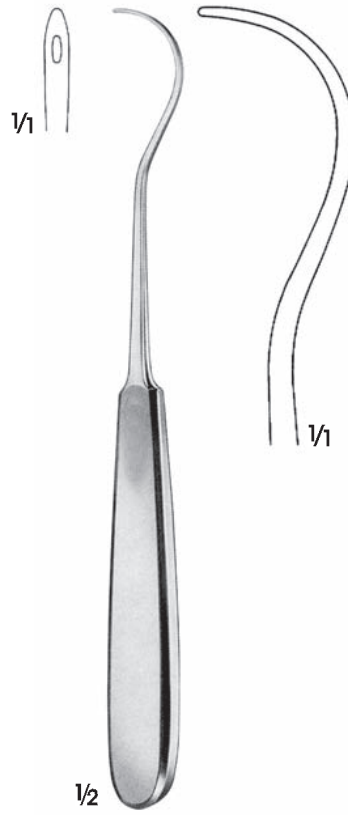

KOCHER
BM 456.00
20.5 cm

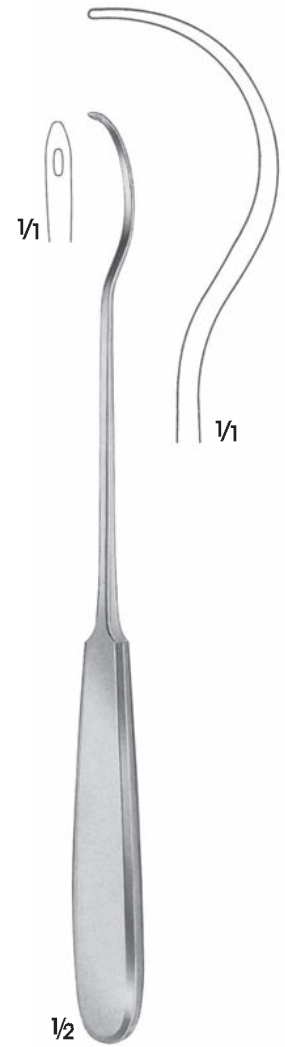

BRUNNER
BM 461.00
24 cm

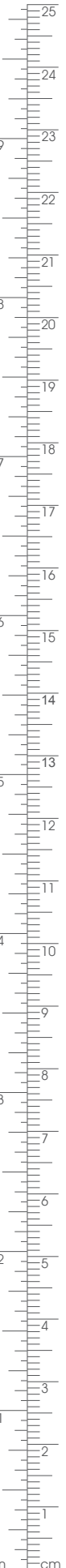

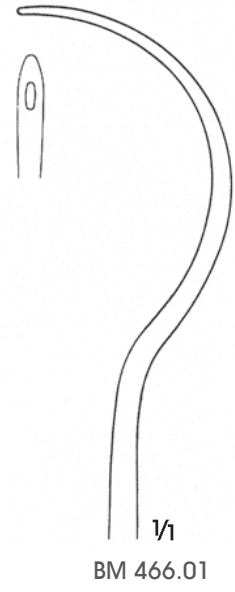

1/2

BRUNNER
BM 465.00-BM 465.01
Kılavuz sondaları/Guiding probes
30 cm

1/2

BRUNNER
BM 466.00-BM 466.01
Bağlama iğneleri/Ligature needles
30 cm



3 mm

1/1



5 mm

1/1



7 mm

1/1



8 mm

1/1



1/2

BM 480.00
20 cm



1/2

KÖNIG
BM 481.00
19.5 cm



1/2

KÖNIG
BM 482.00
20 cm



1/2

SCHMIEDEN
BM 483.00
18.5 cm

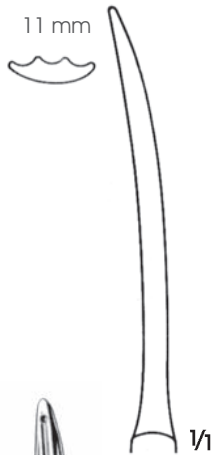

KOCHER
BM 488.00
15 cm

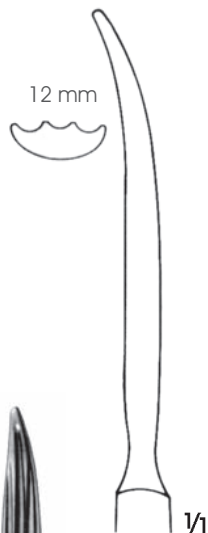

KOCHER
BM 489.00
17 cm



PAYR
BM 484.00
19.5 cm



PAYR
BM 485.00
22.5 cm

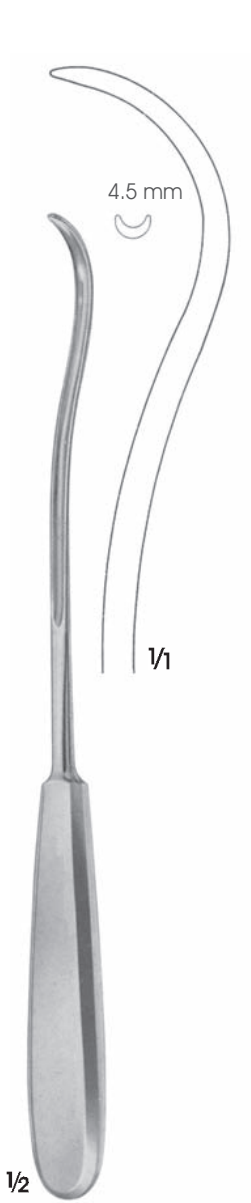

KIRSCHNER
BM 491.00
25.5 cm

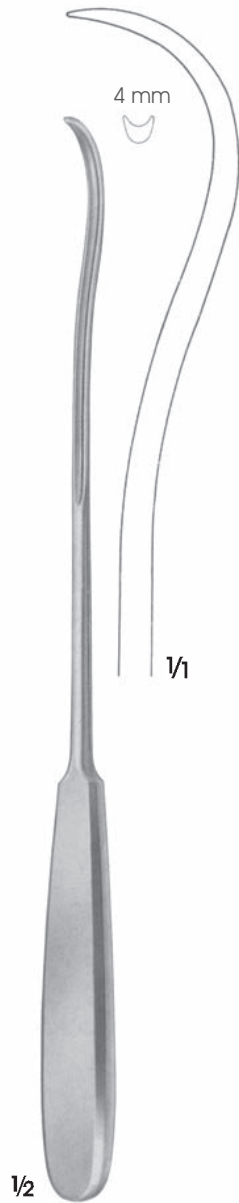

BM 492.00
28 cm



BM 496.00
Ağaç/Wooden
26.5 cm

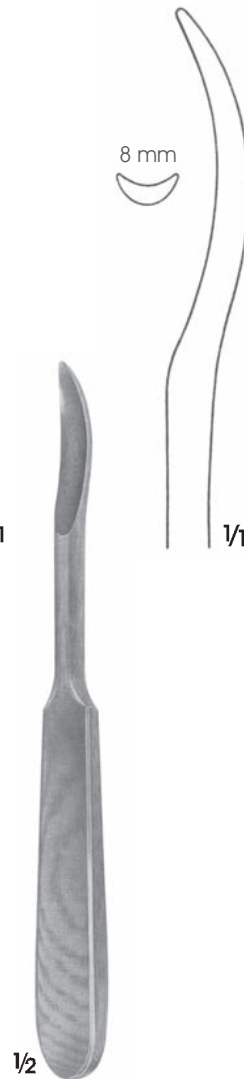

BM 494.00
Ağaç/Wooden
18.5 cm



BM 498.00
Ağaç/Wooden
24 cm





1/2
HEGENBARTH
BN 601.00
Klip uygulayıcı penset
Clip applying forcep
12 cm



1/2
MICHEL
BN 605.00
Klip uygulayıcı penset
Clip applying forcep
12.5 cm



1/2
MICHEL
BN 620.00
Klip uygulayıcı ve çıkarıcı pens
Clip applying and removing forcep
12.5 cm



1/2
MICHEL
BN 621.00
Klip Uygulayıcı ve çıkarıcı pens
Clip applying and removing forcep 13 cm



1/2
COLLIN
BN 630.00
Klip çıkarıcı pens
Clip removing forcep
13.5 cm



1/2
HEATH
BN 631.00
Klip çıkarıcı pens
Clip removing forcep
13.5 cm



1/2
BM 083.00
Düğüm aparatı
Attachment node
23 cm



1/1



1/2
CASPAR
BM 084.02
Düğüm aparatı
Attachment node
23 cm



1/1

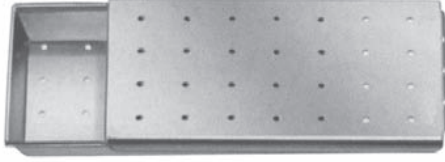

BL 952.00
50 x 25 x 5 mm
BL 952.01
50 x 30 x 6 mm
BL 952.04
70 x 25 x 5 mm

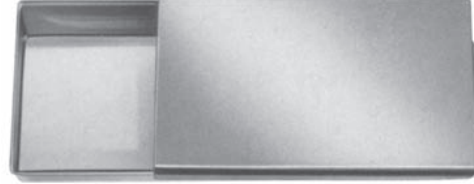

BL 950.00
60 x 25 x 11 mm
BL 950.01
70 x 53 x 9 mm



BL 954.00
150 x 90 x 10 mm



BL 956.00
205 x 120 x 12 mm



BL 960.00 65 x 16 mm İç kutu ve dış kutu takım/Needle case with interior box
BL 962.00 95 x 16 mm İç kutu ve dış kutu takım/Needle case with interior box
BL 964.00 65 x 16 mm F 960.00 için sadece dış kutu/Exterior box of F 960.00
BL 961.00 62 x 17 mm F 960.00 için iç kutu/Interior box of F 960.00 only
BL 963.00 90 x 17 mm F 962.00 için iç kutu/Interior box of F 960.00 only

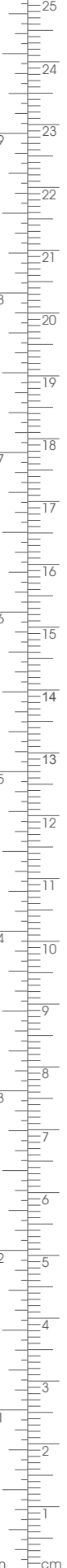

BH Hemostatik Pensler, Diseksiyon Pensleri, Histerektomi Pensleri
Haemostatic Forceps, Dissecting Forceps, Hysterectomy Forceps



 **ARGENT**

Geçici damar tıkkama için:

Güvenli ve dikkatli şekilde damar kavrama

Sabitlenmiş baskı mesafeli, tırtıklı yüzeyli bıyıklar

Kapama kuvveti klipsin ağızlarının 1/3 mesafesinde 1 mm aralık durumunda ölçülür.

For temporary occlusion :

Safe and careful gripping of vessel

Blades with serrated surface and rigidly fixed pressure feature

Closing force is measured at 1/3 of the blades a 1 mm opening



BIEMER

FD 001.00

Çene uzunluğu/Lenght of jaws 6 mm

Açıklık/Opening 4 mm

Kapanma kuvveti/Closing force 30-40 gr. (0.29 - 0.39 N)



FD 002.00

Çene Uzunluğu/Lenght of jaws 9 mm

Açıklık/Opening 5 mm

Kapanma kuvveti/Closing force 30-40 gr. (0.29 - 0.39 N)



BIEMER

FD 003.00

Çene uzunluğu/Lenght of jaws 9 mm

Açıklık/Opening 5 mm

Kapanma kuvveti/Closing force 20-25 gr. (0.20 - 0.25 N)

for vessel Ø 0.5 - 2.0 mm.

S 034.00 ve S 035.00 ile birlikte kullanılır.

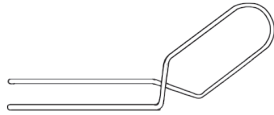

MEHDORN

FD 005.00

Çene uzunluğu/Lenght of jaws 1 mm

Açıklık/Opening 4 mm

Kapanma kuvveti/Closing force 10-15 gr. (0.10 - 0.15 N)



MEHDORN

FD 005.01

Çene uzunluğu/Lenght of jaws 1.4 mm

Açıklık/Opening 4 mm

Kapanma kuvveti/Closing force 15-20 gr. (0.15 - 0.20 N)



MEHDORN

FD 005.05

Çene uzunluğu/Lenght of jaws 1 mm

Açıklık/Opening 6 mm

Kapanma kuvveti/Closing force 10-15 gr. (0.10 - 0.15 N)



MEHDORN

FD 005.06

Çene uzunluğu/Lenght of jaws 1.4 mm

Açıklık/Opening 6 mm

Kapanma kuvveti/Closing force 15-20 gr. (0.15 - 0.20 N)



for vessel Ø 0.5 - 2.0 mm.

S 032.00 ile birlikte kullanılır.

Mikro damar anastomileri için:
Güvenli ve dikkatli şekilde damar kavrama.
Sabitlemiş baskı mesafeli, tırtıllı yüzeyli bleydler.
Klipsler arası mesafe ayarlanabilir.
Bükerek otomatik sabitleme.

For micro vessel anastomosis:
Safe and careful gripping of vessel.
Blades with serrated surface and rigidly fixed pressure feature.
Adjustable distance between clips.
Automatic fixation by tilling



BIEMER-MÜLLER
FD 010.00

Çene uzunluğu/Lenght of jaws.6 mm
Açıklık/Opening 4 mm
Kapanma kuvveti/Closing force 30-40 gr.



BIEMER-MÜLLER
FD 011.00

Çene uzunluğu/Lenght of jaws.4.5 mm
Açıklık/Opening 3 mm
Kapanma kuvveti/Closing force 25-30 gr.

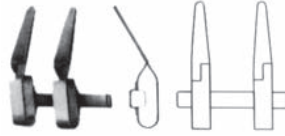

BIEMER-MÜLLER
FD 012.00

Çene uzunluğu/Lenght of jaws.9 mm
Açıklık/Opening 5 mm
Kapanma kuvveti/Closing force 25-30 gr.



BIEMER-MÜLLER
FD 013.00

Çene uzunluğu/Lenght of jaws.9 mm
Açıklık/Opening 5 mm
Kapanma kuvveti/Closing force 25-30 gr.

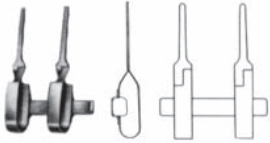

BIEMER-MÜLLER
FD 014.00

Çene uzunluğu/Lenght of jaws.9 mm
Açıklık/Opening 5 mm
Kapanma kuvveti/Closing force 25-30 gr.

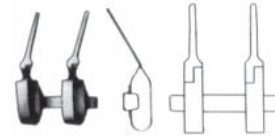

BIEMER-MÜLLER
FD 015.00

Çene uzunluğu/Lenght of jaws.9 mm
Açıklık/Opening 5 mm
Kapanma kuvveti/Closing force 25-30 gr.

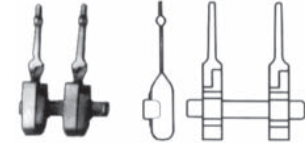

MÜLLER
FD 020.00

Kapanma kuvveti/Closing force. 25-30 gr.

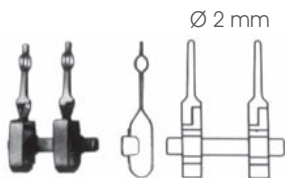

MÜLLER
FD 021.00

Kapanma kuvveti/Closing force. 25-30 gr.

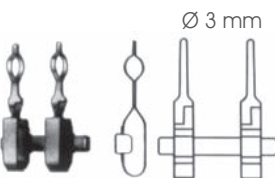

MÜLLER
FD 022.00

Kapanma kuvveti/Closing force. 25-30 gr.

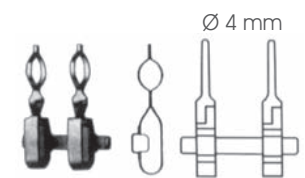

MÜLLER
FD 023.00

Kapanma kuvveti/Closing force. 25-30 gr.





1/1

BIEMER
FD 035.00
Kilitsiz/Without lock



1/1

BIEMER
FD 034.00
Kilitleli/With lock



1/1



1/1

BIEMER
FD 024.00
Uygulama pensetleri, damar klipsleri,
BIEMER-MÜLLER ve MÜLLER aproksi-
matör.
Applying forceps for BIEMER
vessel approximator
14.5 cm



1/1

BIEMER
FD 010.01
Komple/Complete
FD 010.00
Sadece aproksimatör
Approximator only
FD 024.00
Klip penset Applying
Forceps



1/1

MEHDORN
FD 032.00
Uygulama pensetleri, MEHDORN
damar klipsleri
Applying forceps for MEHDORN
vessel clips
15 cm

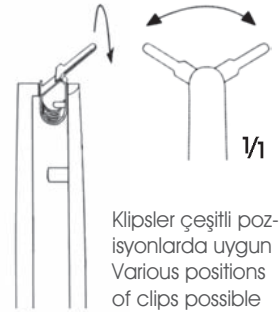

Klipsler çeşitli poz-
isyonlarda uygun
Various positions
of clips possible

BIEMER
FD 034.00-FD 035.00
BIEMER damar klipsleri ve BIEMER-MÜLLER ve
MÜLLER yaklaştırıcılar için başvuru pensleri
Applying forceps for BIEMER vessel clips and
BIEMER-MÜLLER and MÜLLER approximators
14 cm



BIEMER
FD 025.00
Komple Aproksimatör,
anahtarı ile S 029.00 Approximator, complete with key S 029.00

Derin aralıkta mikro damar anastomileri için.

- Güvenli ve dikkatli şekilde damar kavrama.
- Tırtıklı yüzeyli bleydler.
- Anahtar ile (S 029.00) basınç ayarı.
- Anahtar ile (S 029.00) klipsler arası mesafenin ayarlanması ve sabitlenmesi.

For micro vessel anastomosis

- Safe and careful gripping of vessel.
- Blades with serrated blade surface
- Pressure adjustment with use of key(S 029.00)
- Adjustment of distance between blades and fixation of blades with a use of key(S 029.00)



BIEMER
FD 026.00
Komple Aproksimatör,
anahtarı ile S 029.00
Approximator, complete
with key S 029.00

Sinir anastomilerine güvenli adaptasyon

- Sinir merkezinin, güçlü patolojik değişiklikleri önleyen hassas iğneler ile delinmesi
- Anahtar(S 029.00) kullanımı ile değiştirilebilir iğneler.
- Anahtar ile iğneler arası mesafenin ayarlanması ve sabitlenmesi

Safe adaptation of nerve anastomoses

- Piercing the nerve center with fine needles that prevents strong pathological changes
- Changeable needles with use of key.(S 029.00)
- Adjustment of distance between needles and fixation of needles with use of key(S 029.00)

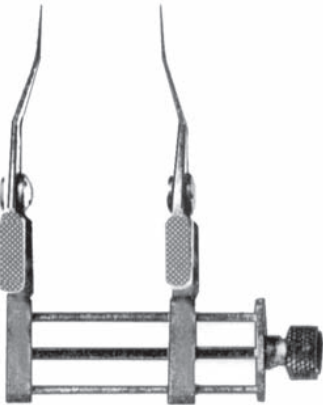

FD 030.00
Approximator

Derin aralıkta mikro damar anastomileri için.

- Güvenli ve dikkatli şekilde damar kavrama.
- Tırtıklı yüzeyli bleydler.
- El ile basınç ayarı yapabilme özelliği.
- Mesafeyi el ile yakınlaştırma ve uzaklaştırma.

For micro vessel anastomosis

- Safe and careful gripping of vessel.
- Blades with serrated blade surface
- The ability to manually set the pressure
- Distance, zoom in and out manually.



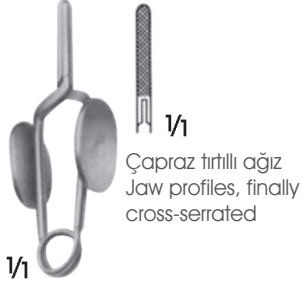

Çapraz tırtıllı ağız
Jaw profiles, finally
cross-serrated

1/1

MÜLLER
FE 014.00
Dikiş pensi
Ligature forceps

Travmatik olmayan damar klipleri, Geçici Non-traumatic Vessel Clips, temporary



MÜLLER
FE 015.00
Kapama kuvveti 50 gr/Düz
Closing Forceps 50 gr/Straight
FE 016.00
Kapama kuvveti 80 gr/Düz
Closing forceps 80 gr/Straight



MÜLLER
FE 015.05
Kapama kuvveti 50 gr/Eğri
Closing forceps 50 gr/Curved
FE 016.05
Kapama kuvveti 80 gr/Eğri
Closing forceps 80 gr/Curved



MÜLLER
FE 015.10
Kapama kuvveti 50 gr/Eğri
Closing forceps 50 gr/Curved
FE 016.10
Kapama kuvveti 80 gr/Eğri
Closing forceps 80 gr/Curved



MÜLLER
FE 015.15
Kapama kuvveti 50 gr/Yana doğru açılı
Closing forceps 50 gr/Angled to side
FE 016.15
Kapama kuvveti 80 gr/Yana doğru açılı
Closing forceps 80 gr/Angled to side

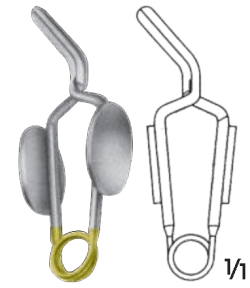

MÜLLER
FE 015.20
Kapama kuvveti 50 gr/Diz bükümlü
Closing Forceps 50 gr/Knee-bent
FE 016.20
Kapama kuvveti 80 gr/Diz bükümlü
Closing Forceps 80 gr/Knee-bent

Özellikler :

- Atromatik ağız profili.
- Her iki tarafta kullanılan tutma plakaları kliplerin güvenli bir şekilde uygulanması ve çıkarılmasına yardımcı olur.
- Ater ve toplar damarlar için kesin olarak tanımlanmış kapama basınçları.
- Damar klemplerinin üzerine kapanma basınçları markalanmıştır.

Features :

- Atraumatic mouth profile.
- Holding plates used on both side of the clips ensure safe application and removal.
- Closing pressure of the clips are exactly defined for arterial and venous vessels.
- Closing pressure of the clips is marked on the clips.

De Bakey Diş



Toothing De Bakey



1/2

MÜLLER

FE 113.00

Kapama kuvveti/Closing force 250 gr

FE 113.01

Kapama kuvveti/Closing force 350 gr

Düz/Straight



1/2

MÜLLER

FE 114.00

Kapama kuvveti/Closing force 250 gr

FE 114.01

Kapama Kuvveti/Closing force 350 gr

Eğri/Curved



1/2

MÜLLER

FE 115.00

Kapama kuvveti/Closing force 250 gr

FE 115.01

Kapama kuvveti/Closing force 350 gr

Eğri/Curved



1/2

MÜLLER

FE 116.00

Kapama kuvveti/Closing force 250 gr

FE 116.01

Kapama Kuvveti/Closing Force 350 gr

Diz bükümlü/Knee-bent





1/1

Toplam boy
Total length

Ağız uzunluğu
Length of jaws

DIEFFENBACH

BH 020.00 38 mm 12 mm
BH 020.01 48 mm 16 mm



1/1

Toplam boy
Total length

Ağız uzunluğu
Length of jaws

DIEFFENBACH

BH 021.00 38 mm 12 mm
BH 021.01 48 mm 16 mm



1/1

Toplam boy
Total length

Ağız uzunluğu
Length of jaws

DIEFFENBACH

BH 022.00 58 mm 16 mm



1/1

Toplam boy
Total length

Ağız uzunluğu
Length of jaws

DIEFFENBACH

BH 023.00 58 mm 16 mm



Toplam boy
Total length

Ağız uzunluğu
Length of jaws

DE BAKEY-HESS

BH 030.00 34 mm 20mm
BH 030.01 43 mm 30mm



Toplam boy
Total length

Ağız uzunluğu
Length of jaws

JOHNS-HOPKINS

BH 024.00 38 mm 12 mm
BH 024.01 48 mm 17 mm
BH 024.02 56 mm 25 mm
BH 024.03 63 mm 30 mm
BH 024.04 70 mm 33 mm
BH 024.05 80 mm 42 mm
BH 024.06 91 mm 52 mm



1/2

JOHNS-HOPKINS

BH 026.00

Bulldog klemplerin takılması ve çıkarılması için pens

G 020.00-G 030.01 ve

H 120.00-H 121.03

Forceps for applying and

removing bulldog clamps

G 020.00-G 030.01 and H 120.00-H 121.03

24 cm

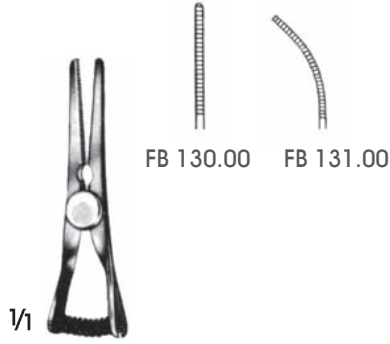

FB 130.00-FB 131.00
Ağız uzunluğu 14 mm
Length of jaws 14 mm
35 m



FB 130.01
Ağız uzunluğu 19 mm
Length of jaws 19 mm
45 mm



FB 131.01
Ağız uzunluğu 19 mm
Length of jaws 19 mm
45 mm



**DIETRICH
MB 010.01**
Ağız uzunluğu 13 mm
Length of jaws 13 mm
55 mm



**DIETRICH
BH 011.03**
Ağız uzunluğu 10 mm
Length of jaws 10 mm
48 mm



**DIETRICH
BH 011.06**
Ağız uzunluğu 13 mm
Length of jaws 13 mm
48 mm



De Bakey Diş



Toothing De Bakey

Kapanma kuvveti 180 gr.
Closing force 180 gr.



1/1

FB 105.00
Ağız uzunluğu 10 mm
Length of jaws 10 mm
Düz/Straight
5 cm



1/1

FB 105.02
Ağız uzunluğu 14 mm
Length of jaws 14 mm
Düz/Straight
5.5 cm



1/1

FB 105.04
Ağız uzunluğu 20 mm
Length of jaws 20 mm
Düz/Straight
6 cm



1/1

FB 106.00
Ağız uzunluğu 20 mm
Length of jaws 20 mm
Eğri/Curved
5.5 cm



55°

1/1

FB 107.00
Ağız uzunluğu 10 mm
Length of jaws 10 mm
Açılı/Angled
5 cm



55°

1/1

FB 107.01
Ağız uzunluğu 14 mm
Length of jaws 14 mm
Açılı/Angled
5 cm



55°

1/1

FB 107.02
Ağız uzunluğu 20 mm
Length of jaws 20 mm
Açılı/Angled
5.5 cm

De Bakey Diş



Toothing De BAkey



DE BAKEY
FB 137.00
Ağız uzunluğu 27 mm
Length of jaws 27 mm
4.8 cm



DE BAKEY
FB 138.01
Ağız uzunluğu 38 mm
Length of jaws 38 mm
7.3 cm

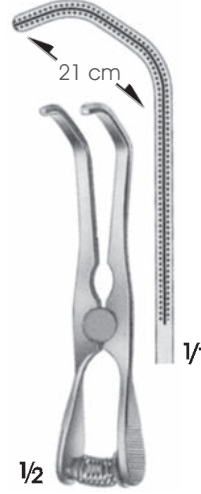

DE BAKEY
FB 139.00
Ağız uzunluğu 63 mm
Length of jaws 63 mm
9.9 cm

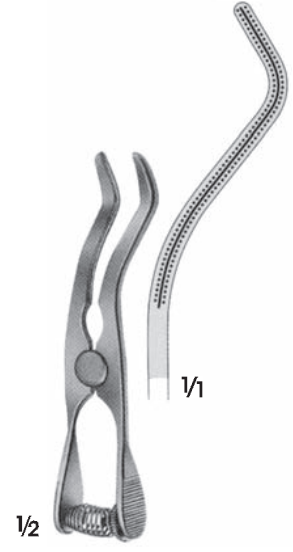

DE BAKEY
FB 140.00
Ağız uzunluğu 54 mm
Length of jaws 54 mm
9.5 cm



DE BAKEY
FB 136.00
Ağız uzunluğu 27 mm
Length of jaws 27 mm
5 cm



GLOVER
FB 134.00
Ağız uzunluğu 35 mm
Length of jaws 35 mm
5.2 cm



	Toplam boy Total length	Ağız uzunluğu Length of jaws
GLOVER FB 136.01	6.8 cm	33 mm
FB 136.02	9.6 cm	50 mm
FB 136.03	11.7 cm	69 mm



	Toplam boy Total length	Ağız uzunluğu Length of jaws
GLOVER FB 137.01	6.5 cm	33 mm
FB 137.02	9.1 cm	50 mm
FB 137.03	11 cm	69 mm



	Toplam boy Total length	Ağız uzunluğu Length of jaws
DE BAKEY FB 120.00	8.0 cm	25 mm
FB 120.01	9.0 cm	35 mm
FB 120.02	10.5 cm	50 mm
FB 120.03	12.4 cm	68 mm



	Toplam boy Total length	Ağız uzunluğu Length of jaws
DE BAKEY FB 121.00	7.8 cm	23 mm
FB 121.01	8.6 cm	31 mm
FB 121.02	9.7 cm	42 mm
FB 121.03	11.4 cm	58 mm





CARREL
BH 609.00
8.5 cm

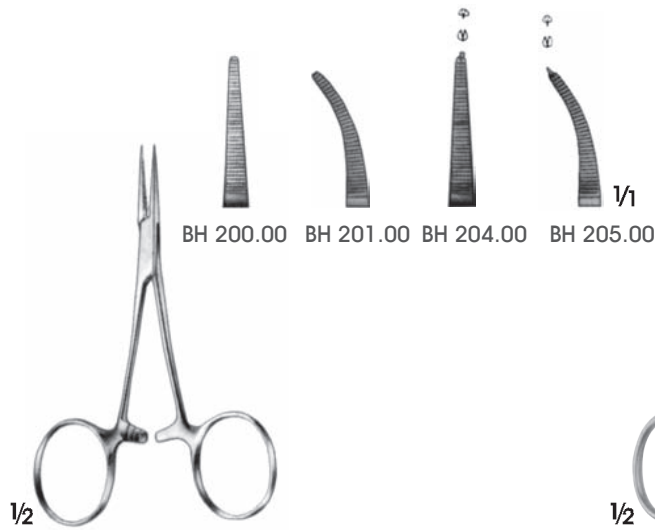

BABY-MOSQUITO
(HARTMANN)
BH 200.00-BH 205.00
10 cm



DUNHILL
BH 212.00
12.5 cm

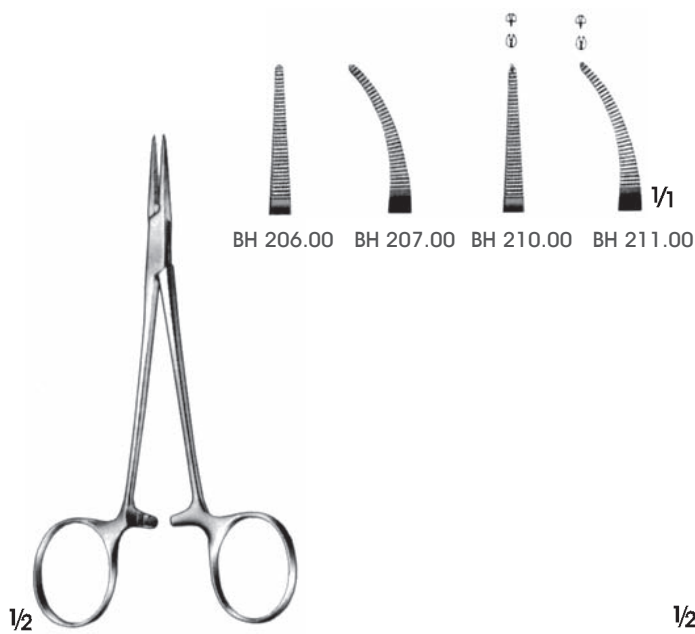

MICRO-HALSTED
BH 206.00-BH 211.00
12.5 cm

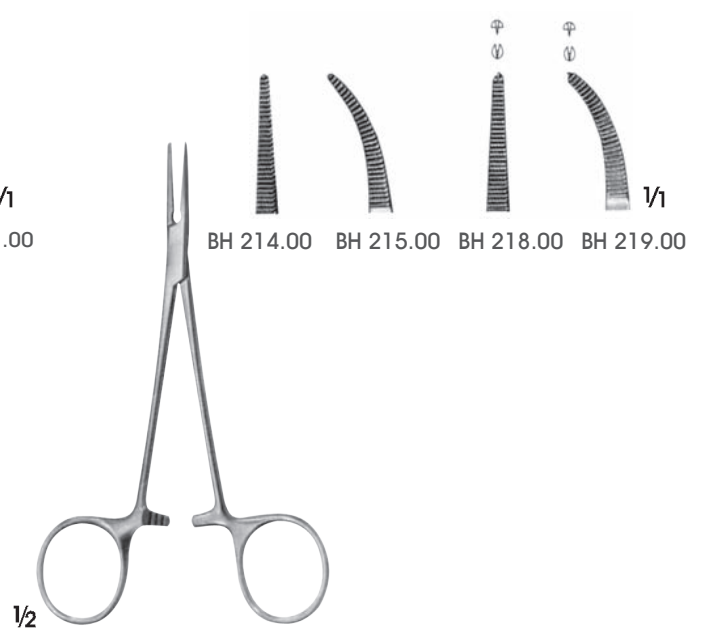

HALSTED-MOSQUITO
BH 214.00-BH 219.00
12.5 cm

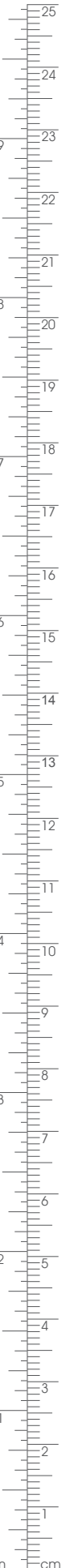
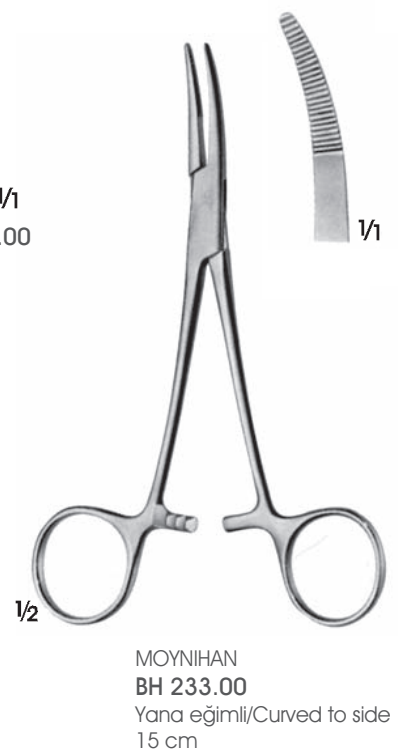
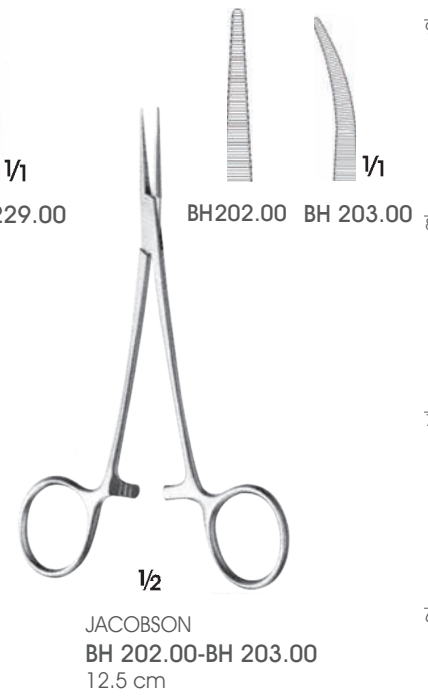
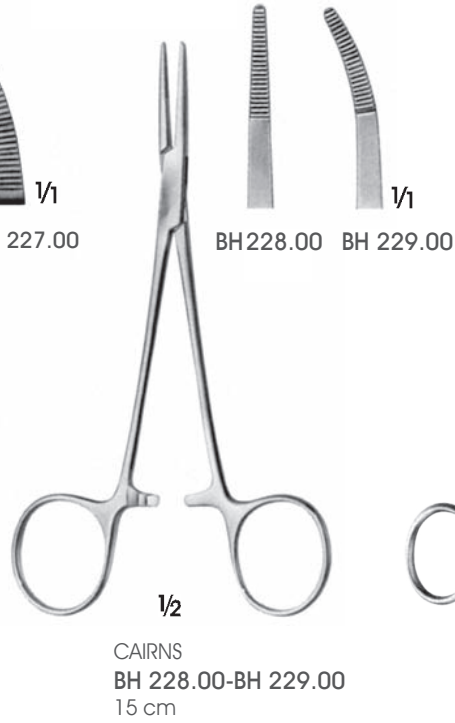
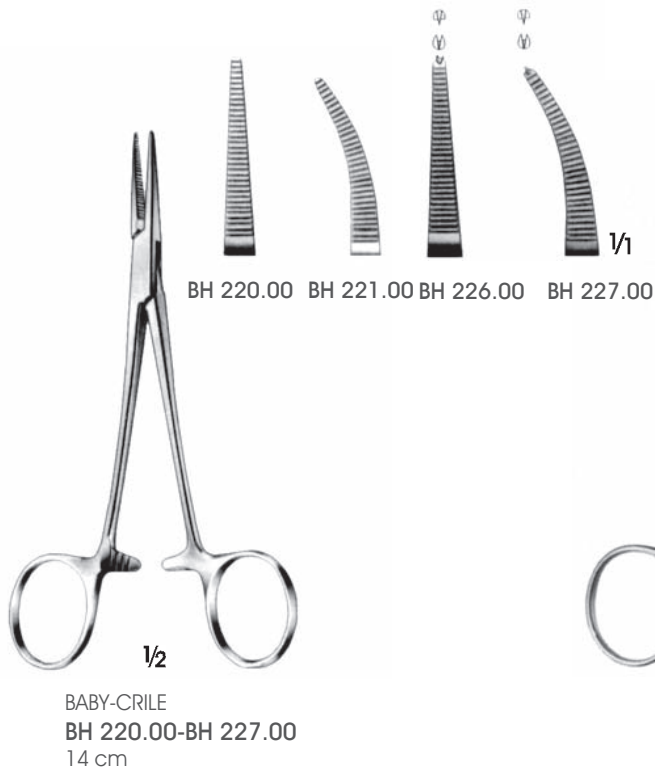



CAIRNS
BH 237.00
Yana eğimli/Curved to side
14.5 cm



DANDY
BH 238.00-BH 239.00
Yana eğimli/Curved to side
14 cm



CRILE
BH 240.00-BH 245.00
14 cm



LERICHE
BH 250.00-BH 255.00



RANKIN
BH 260.00-BH 261.00
16 cm



BH 260.00



BH 261.00 $\frac{1}{1}$



CRILE
BH 264.00-BH 269.00
16 cm



BH 264.00



BH 265.00



BH 268.00



BH 269.00 $\frac{1}{1}$

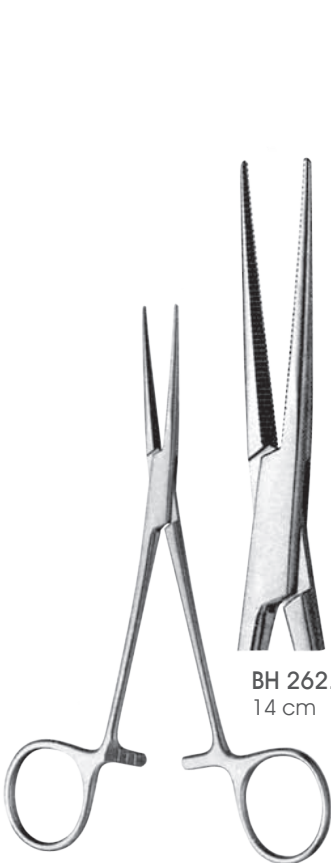

COLLER
BH 262.01-BH 262.13



BH 262.01
14 cm



BH 262.02
16.5 cm



BH 262.03
18.5 cm

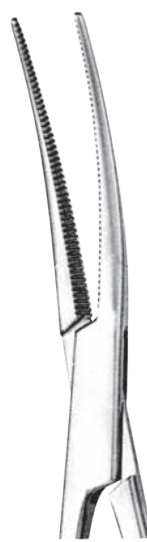

BH 262.11
14 cm



BH 262.12
16.5 cm

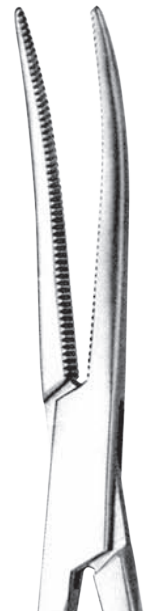

BH 262.13
18.5 cm $\frac{1}{1}$

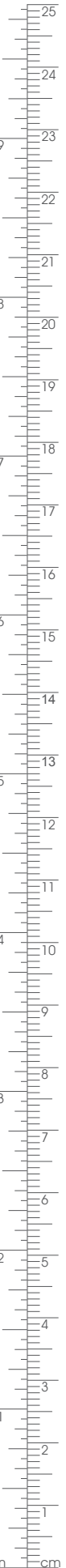



DIXON-LOVELACE
BH 270.00-BH 271.00
16 cm



FUCHSIG
BH 274.00
19.5 cm

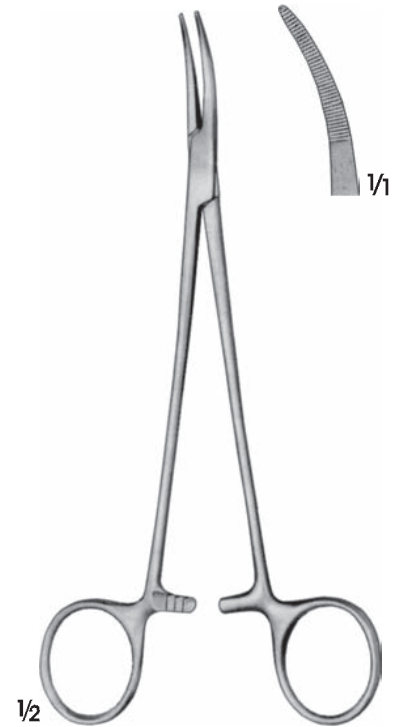

NISSEN
BH 275.00
18.5 cm

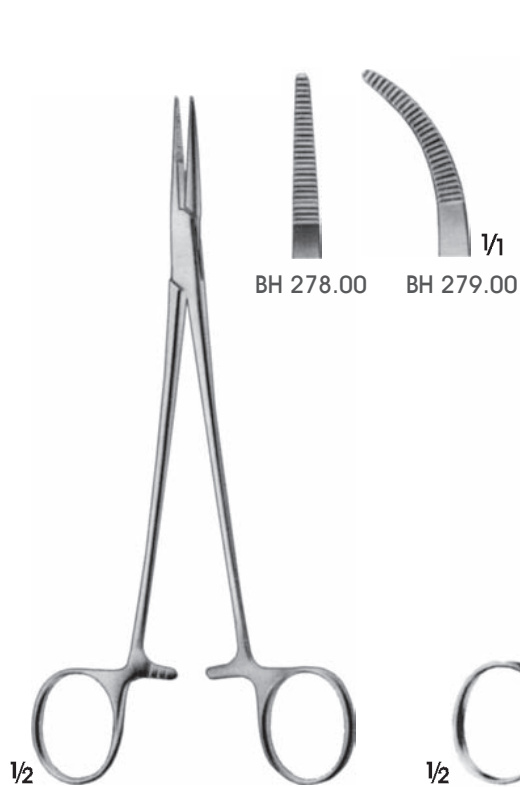

ADSON
BH 278.00-BH 279.00
18.5 cm

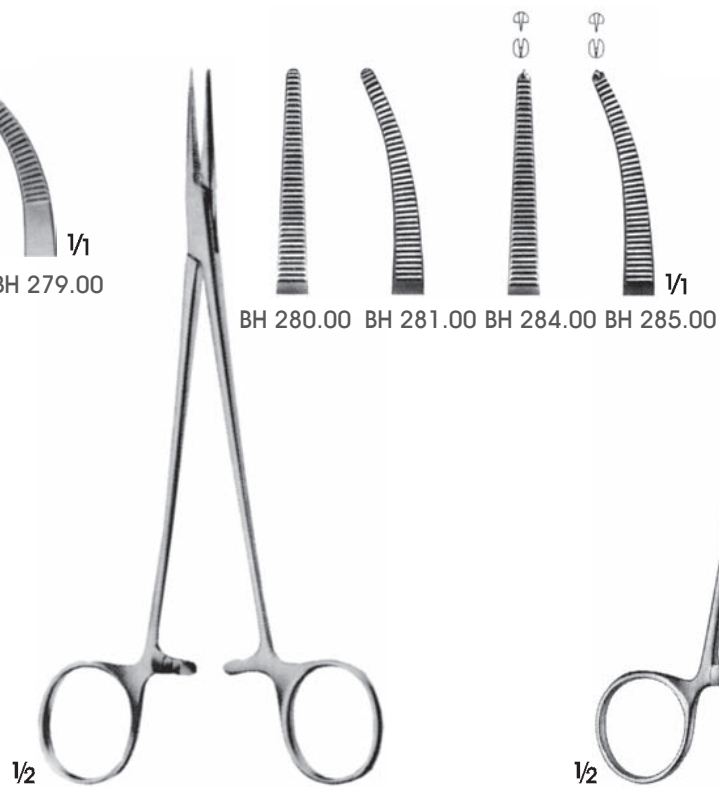

HALSTED
BH 280.00-BH 285.00
18.5 cm



GREY-TURNER
BH 286.00
18 cm



BH 288.00 BH 289.00

1/2

BIRKETT
BH 288.00 - BH 289.00
18.5 cm



BH 290.00 BH 291.00 BH 294.00 BH 295.00

1/2

HALSTED-MOSQUITUO
BH 290.00 - BH 295.00
20 cm



1/1

1/2

FRASER-KELLY(CRILE)
BH 276.00
18 cm



1/1

1/2

DUNHILL
BH 277.00
19 cm



1/1

1/2

JACOBSON
BH 273.00
19 cm



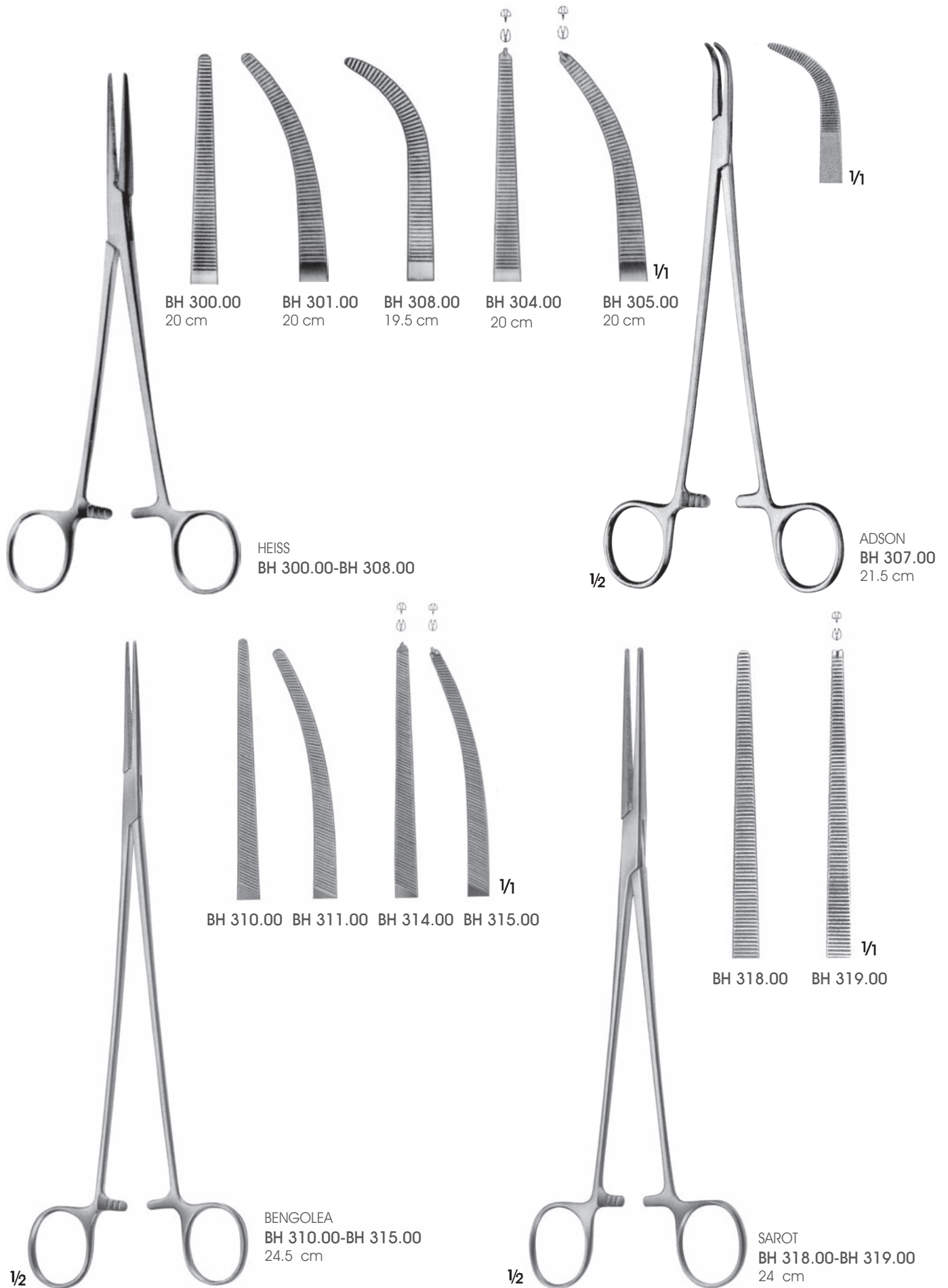



CRAFOORD
BH 320.00
24.5 cm



CRAFOORD, MOD.
BH 322.00
24 cm

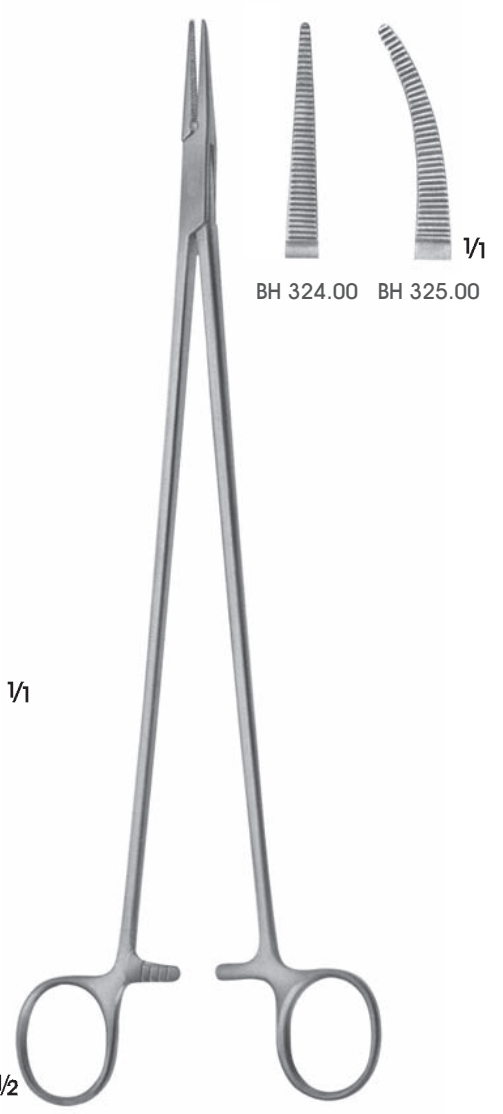

BRIDGE
BH 324.00-BH 325.00
27.5 cm

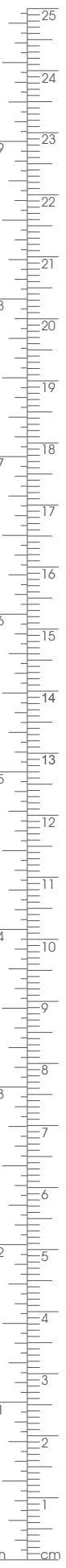

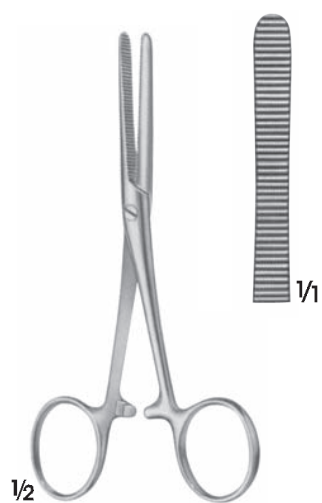

PEAN
BH 400.00
12.5 cm



KRÖNLEIN
BH 401.00
13 cm



PEAN
BH 402.00
12.5 cm



PEAN
BH 404.00-BH 404.01



BH 404.00
12.5 cm



BH 404.01
14 cm

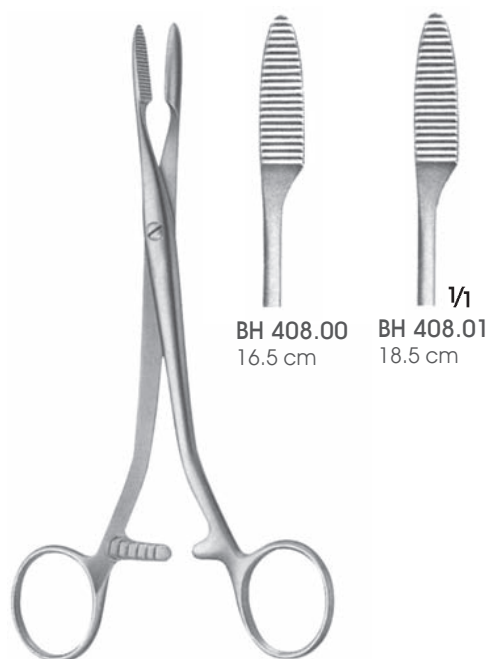

PEAN
BH 408.00-BH 408.01



BH 408.00
16.5 cm



BH 408.01
18.5 cm



PEAN
BH 420.00-BH 421.01
Ince model/Slender type

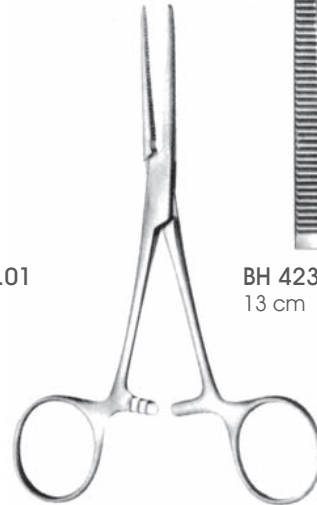
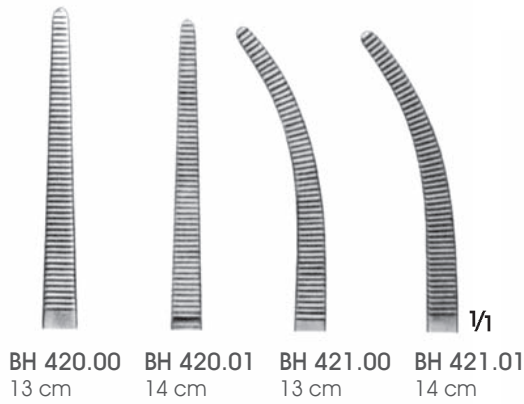

PEAN
BH 423.00-BH 424.00

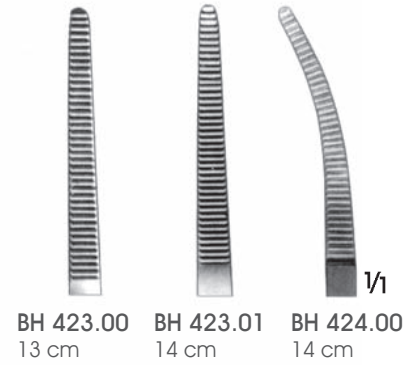

SPENCER - WELLS
BH 427.00-BH 428.04

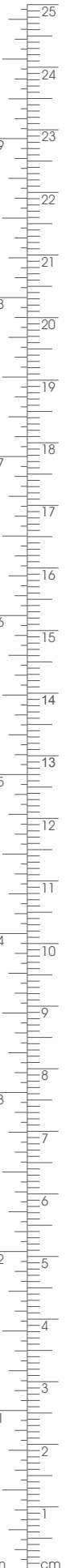
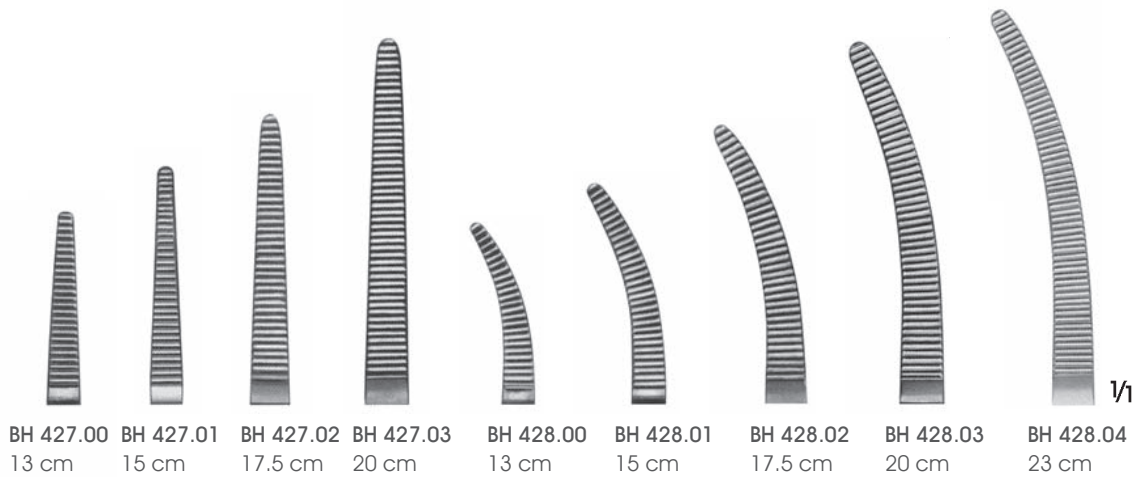

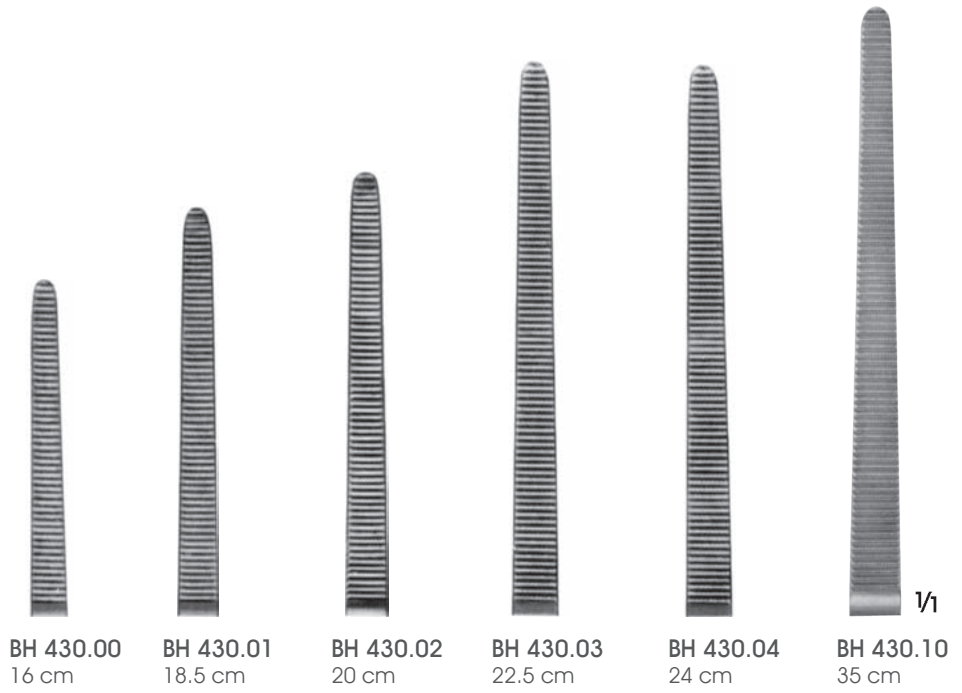

BH 430.00
16 cm

BH 430.01
18.5 cm

BH 430.02
20 cm

BH 430.03
22.5 cm

BH 430.04
24 cm

BH 430.10
35 cm

1/1

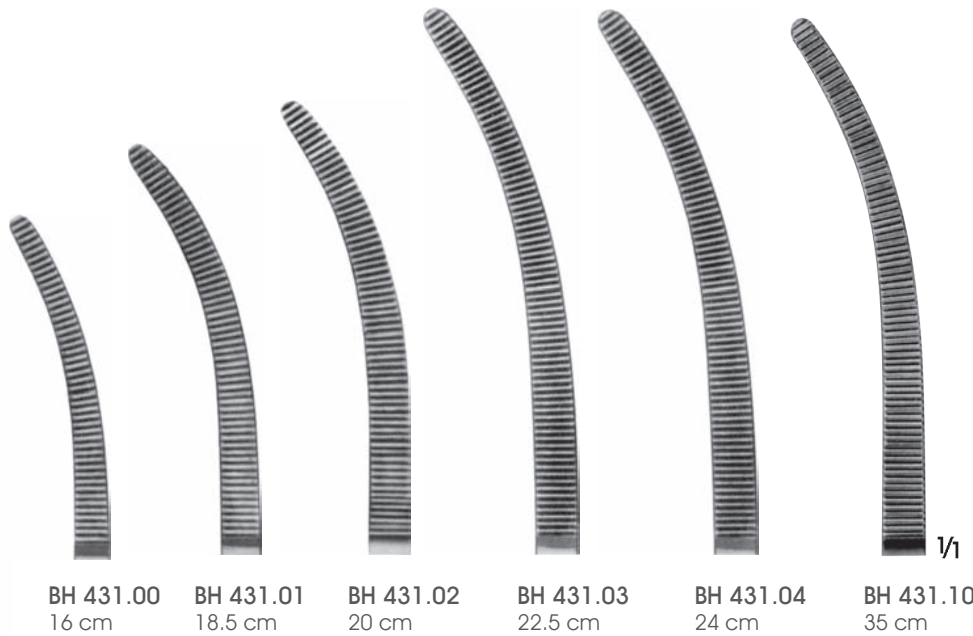

BH 431.00
16 cm

BH 431.01
18.5 cm

BH 431.02
20 cm

BH 431.03
22.5 cm

BH 431.04
24 cm

BH 431.10
35 cm

1/1

ROCHESTER - PEAN
BH 430.00-BH 431.10



PEAN
BH 434.00-BH 435.02

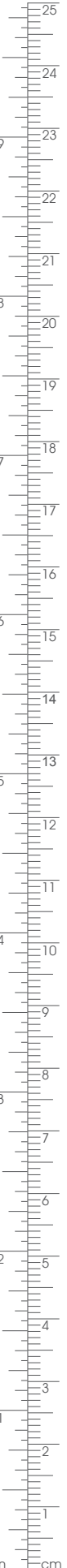
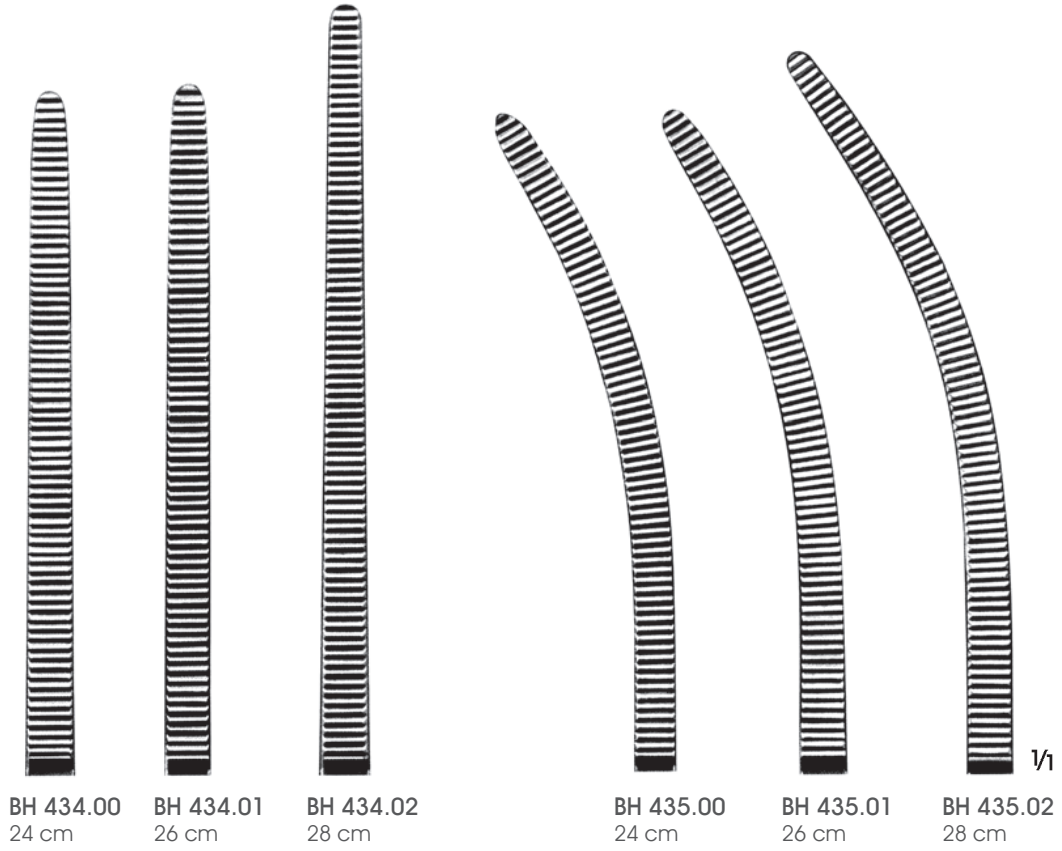



1/2

KOCHER
BH 437.00
Güçlü model/Strong pattern
14.5 cm

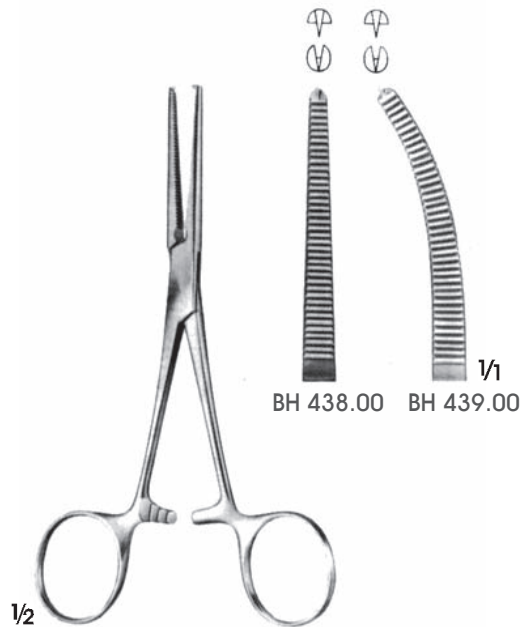

1/2

ROCHESTER-OCHSNER
BH 438.00-BH 439.00
14 cm

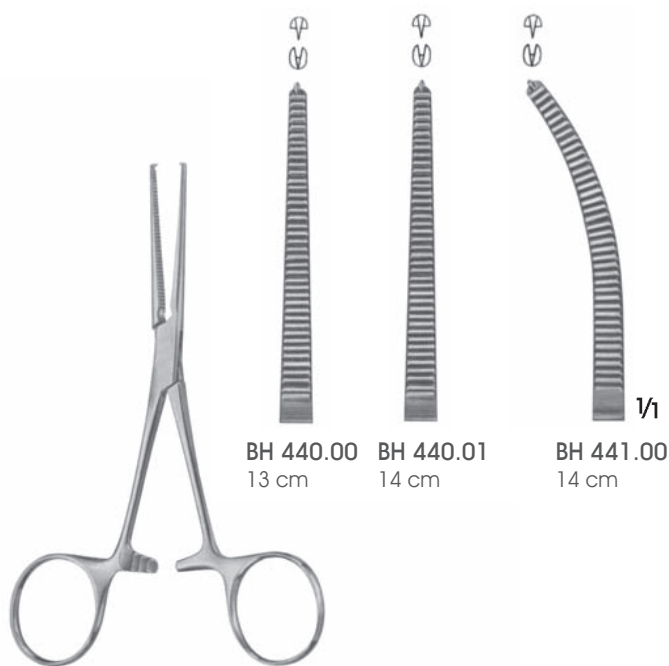

1/2

KOCHER
BH 440.00-BH 441.00



1/2

KOCHER
BH 444.00-BH 445.00
15 cm

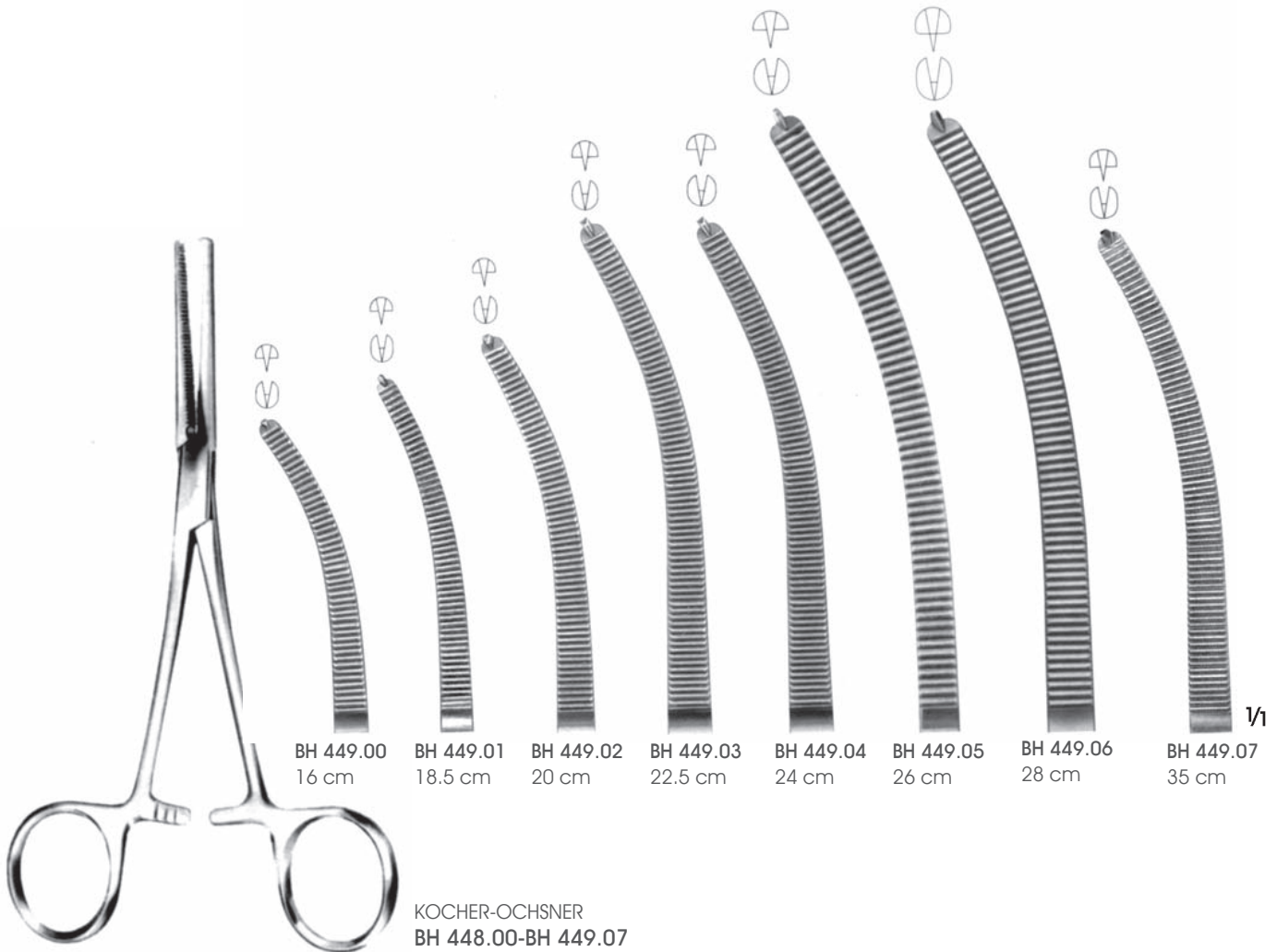
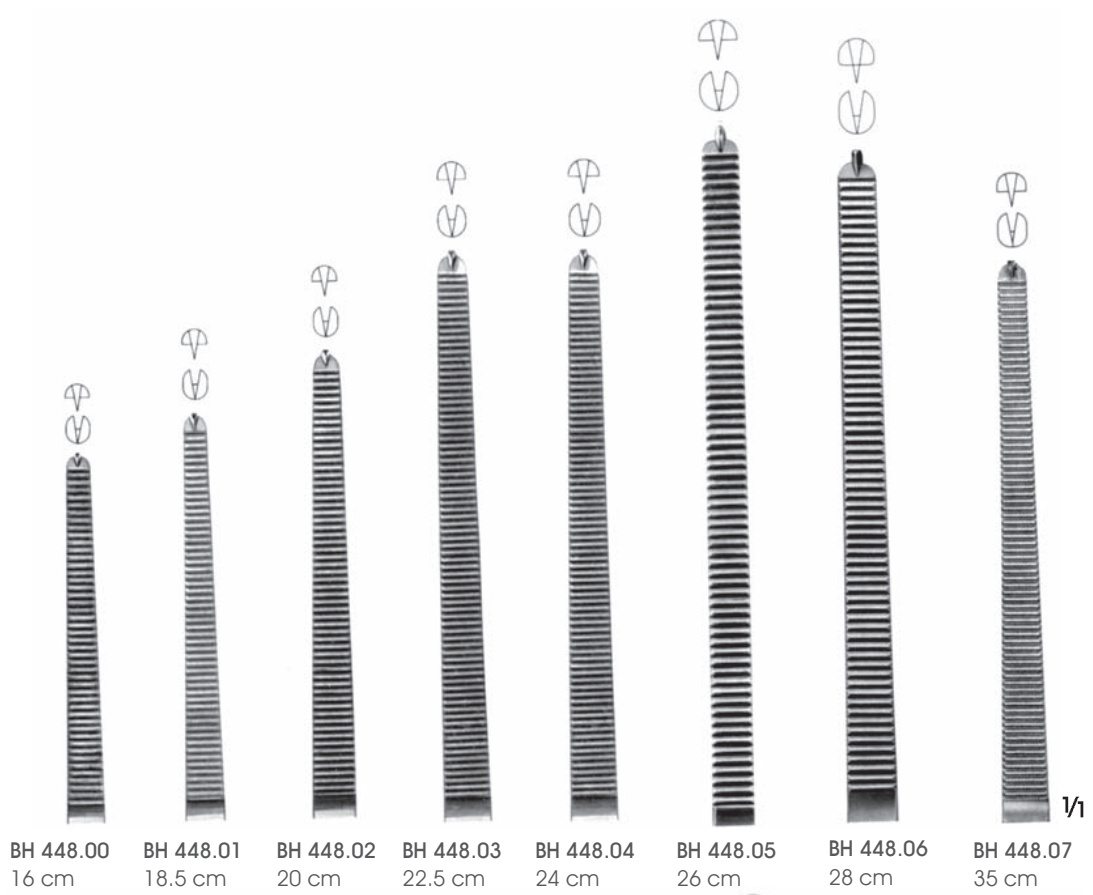



BH 450.00
16 cm



BH 450.01
20 cm



BH 451.00
16 cm



BH 451.01
20 cm

ROCHESTER-CARMALT
BH 450.00-BH 451.01



BH 446.00



BH 447.00
1x2 diş
1x2 teeth

FICKLING
BH 446.00-BH 447.00
18 cm



BH 456.00
23 cm



BH 457.00
24 cm

MOYNIHAN
BH 456.00-BH 457.00



BH 454.00



BH 455.00

ROBERTS
BH 454.00-BH 455.00
25 cm

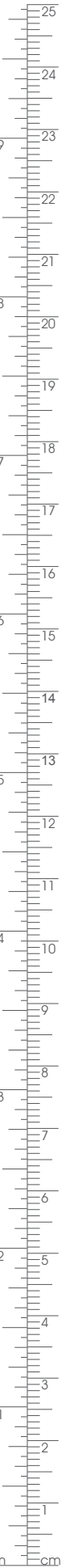
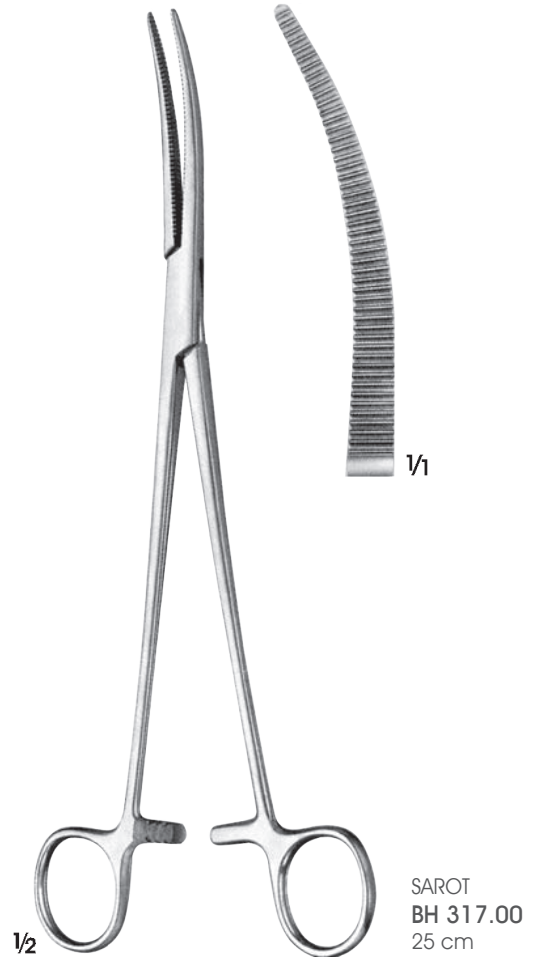

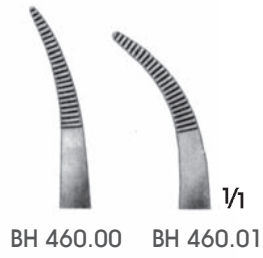

1/2
 SCHNIDT
 BH 460.00-BH 460.01
 18.5 cm

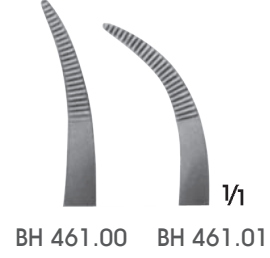

1/2
 SCHNIDT
 BH 461.00-BH 461.01
 18.5 cm

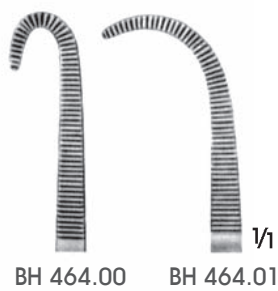

1/2
 NEGUS
 BH 464.00-BH 464.01
 19 cm

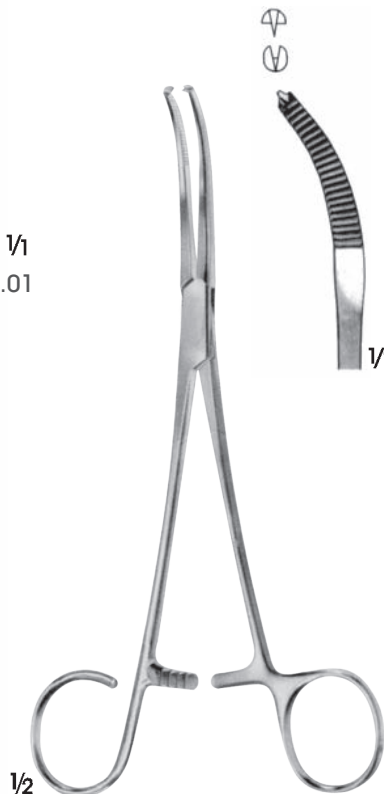

1/2
 MIKULICZ
 BH 466.00
 18.5 cm

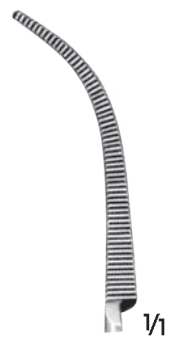
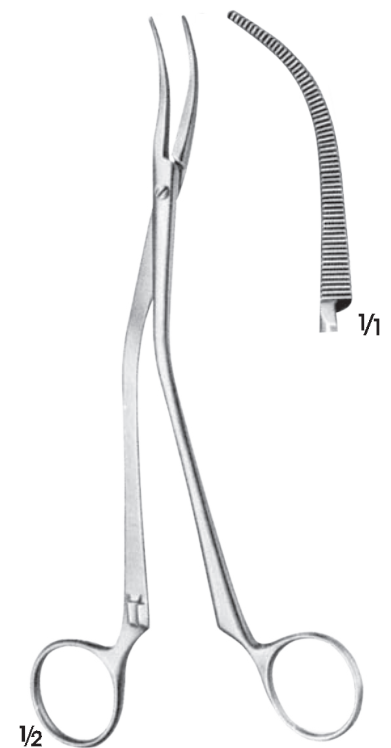

1/2
 WILSON
 BH 465.00
 19 cm

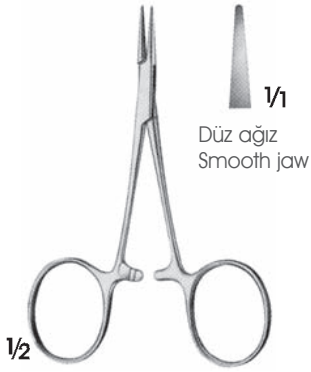
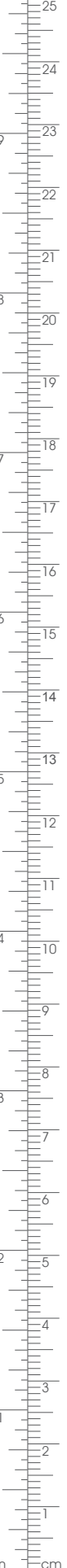

$\frac{1}{1}$
Düz ağız
Smooth jaw

$\frac{1}{2}$
BJ 610.00
Ligatür pensi, düz
Ligature forcecp, straight
9.5 cm



$\frac{1}{2}$
MICRO-ADSON
BJ 614.00
Diseksiyon pensi
Dissecting forcecp
14 cm

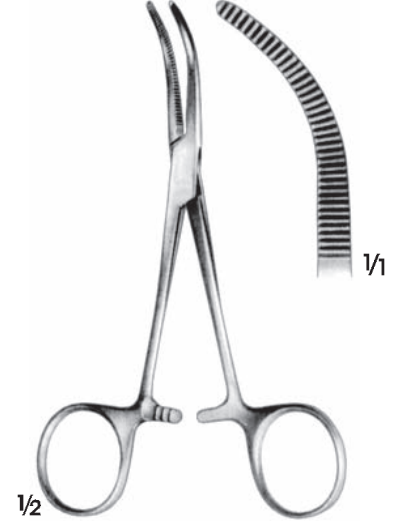

$\frac{1}{2}$
BABY-OVERHOLT
BJ 615.00
Diseksiyon pensi
Dissecting forcecp
13.5 cm



BABY-MIXTER
BJ 616.00-BJ 616.01
Diseksiyon pensleri
Dissecting forcecps

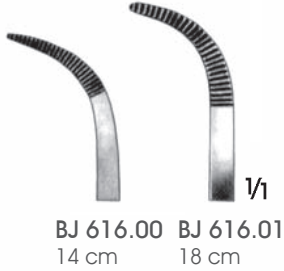

BJ 616.00 **BJ 616.01**
14 cm 18 cm



BABY-ADSON
BJ 617.00-BJ 617.01
Diseksiyon pensleri
Dissecting forcecps

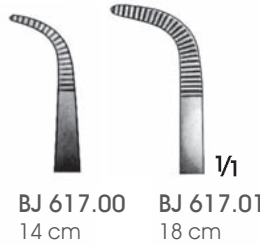

BJ 617.00 **BJ 617.01**
14 cm 18 cm

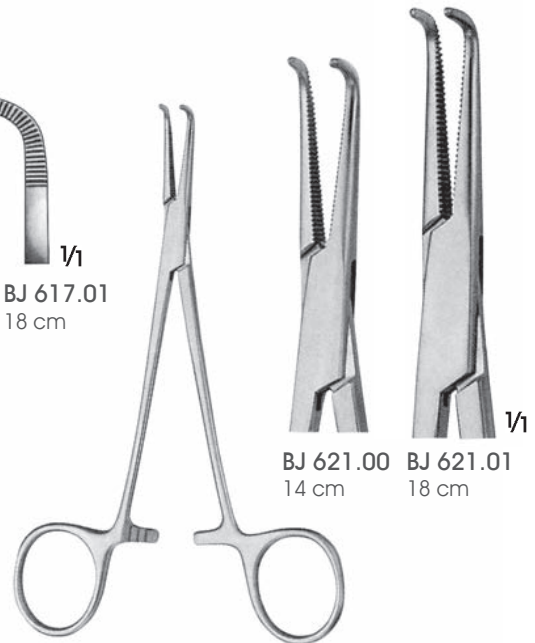

BJ 621.00-BJ 621.01
Diseksiyon pensleri
Dissecting forcecps



BJ 621.00 **BJ 621.01**
14 cm 18 cm



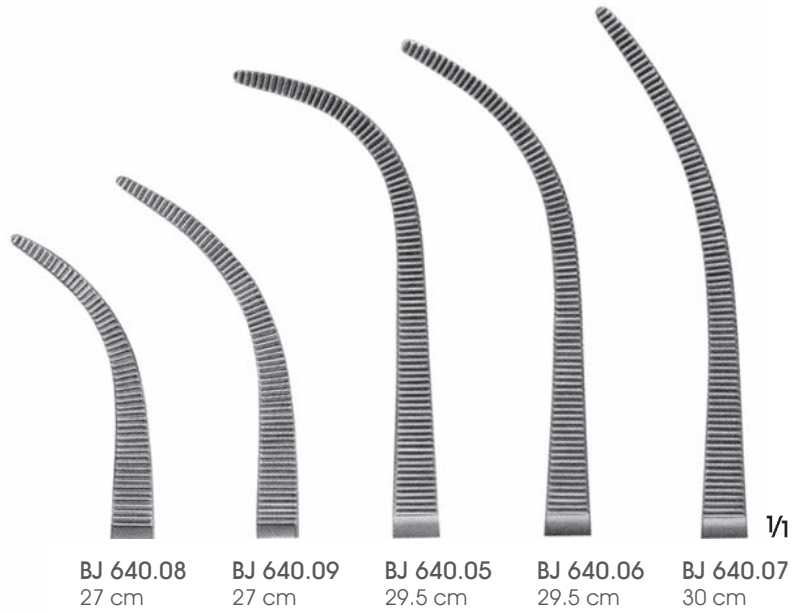
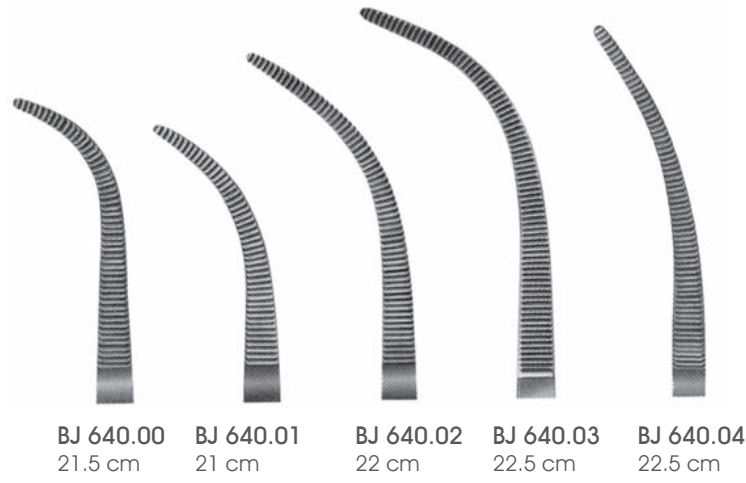

OVERHOLT
BJ 640.00-BJ 640.07
Hassas model/Delicate pattern





OVERHOLT-GEISSENDOERFER
BJ 641.00-BJ 641.04

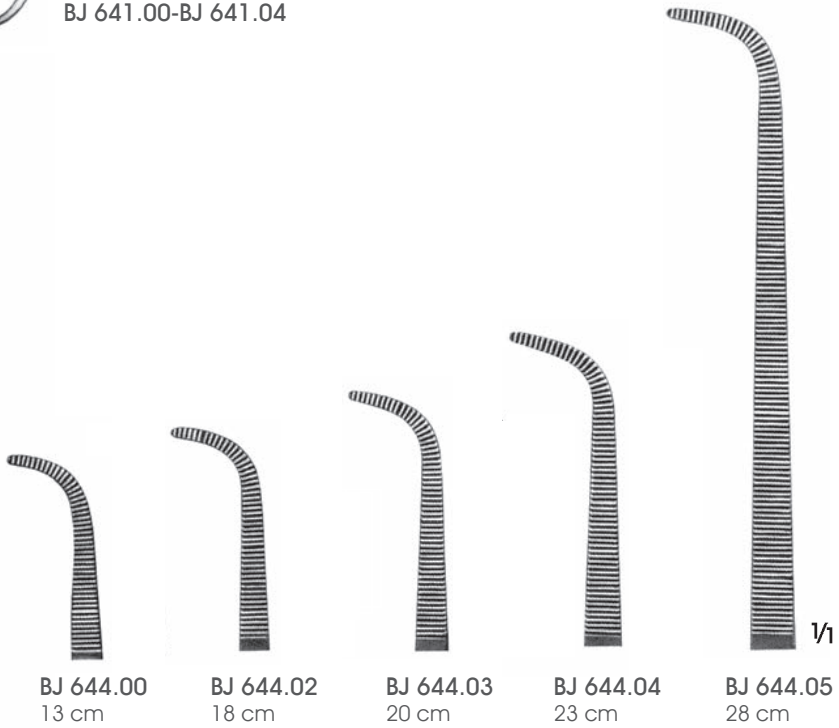

GEMINI
BJ 644.00-BJ 644.06



BJ 652.00
15 cm



BJ 652.01
18 cm



BJ 652.02
20 cm



BJ 652.04
23 cm



BJ 652.05
25.5 cm

1/1

O'SHAUGHNESSY
BJ 652.00-BJ 652.05



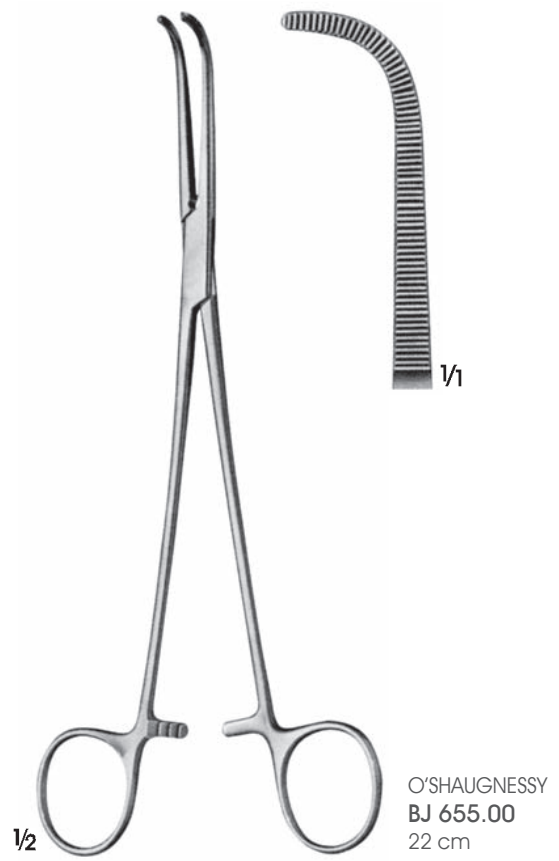
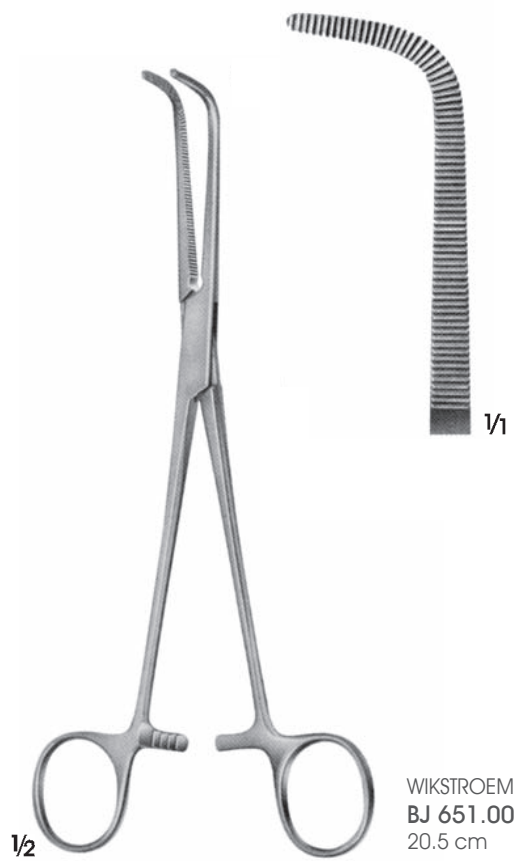



BJ 656.00
20 cm

BJ 656.01
24 cm

BJ 656.02
27.5 cm

KANTROWITZ
BJ 656.00-BJ 656.02



1/1



BJ 657.00
Çok hassas
Extra delicate

BJ 657.05
Hassas
Delicate

BARRE
BJ 657.00-BJ 657.05
28 cm



1/1



BJ 658.00

BJ 658.01

BJ 658.02

BJ 658.03

BJ 658.04

RUMEL
BJ 658.00-BJ 658.04
24 cm

1/2

1/1





ZENKER
BJ 669.00-BJ 669.07



BJ 669.00
30 cm



BJ 669.01
29 cm



BJ 669.04
35 cm



BJ 669.05
35 cm

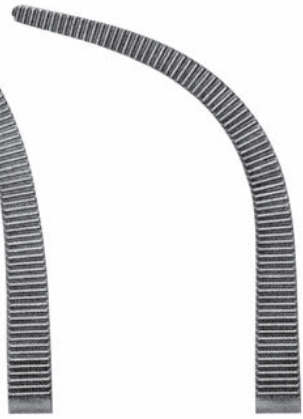

BJ 669.07
35 cm

1/1



MIXTER
BJ 654.00
23 cm



LAWRENCE
BJ 664.00
27 cm

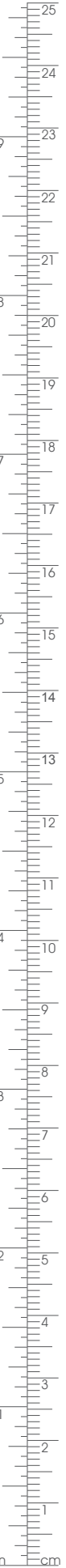

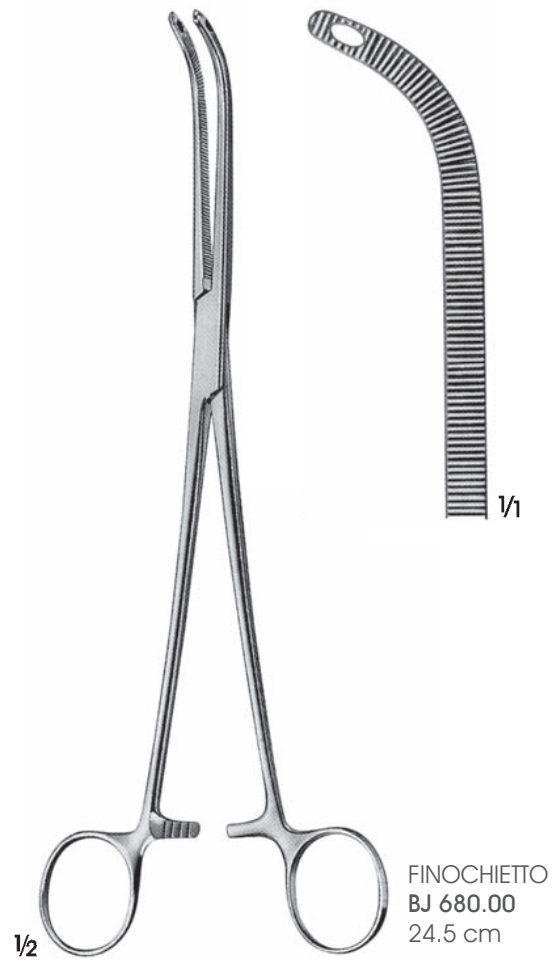
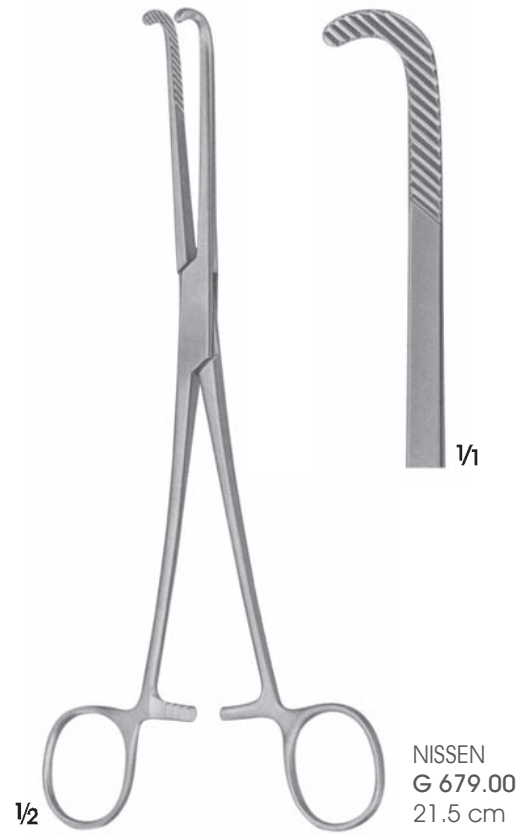
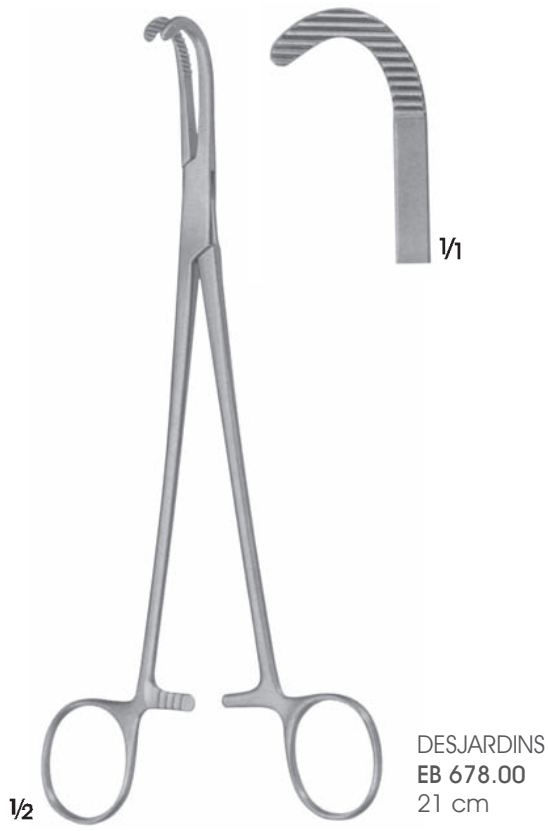

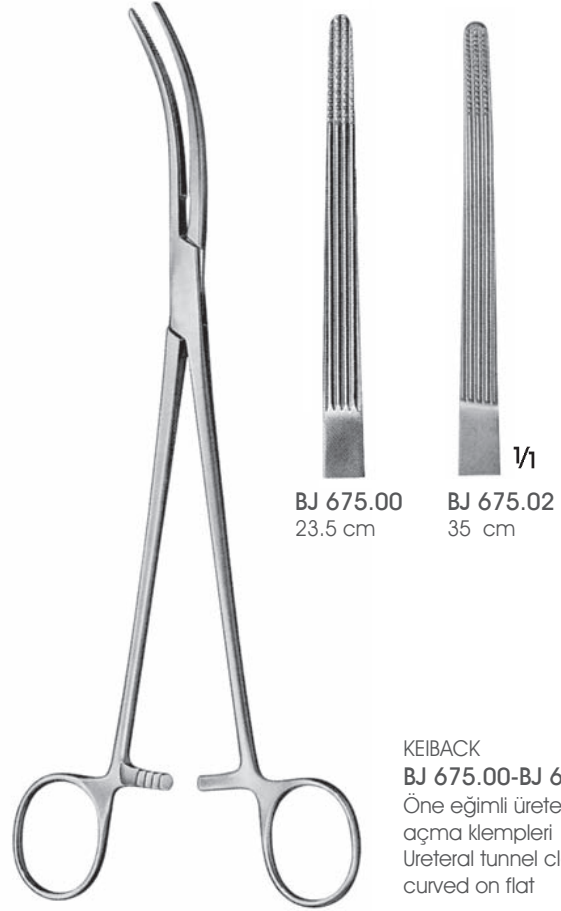
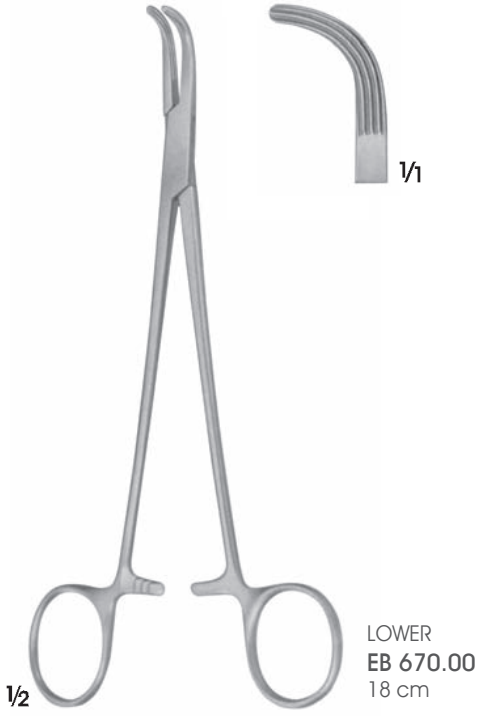
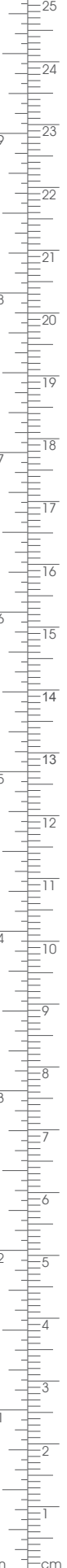



$\frac{1}{2}$
BABY-MIKULICZ
BJ 690.00
14 cm



$\frac{1}{2}$
MIKULICZ
BJ 691.00
18.5 cm

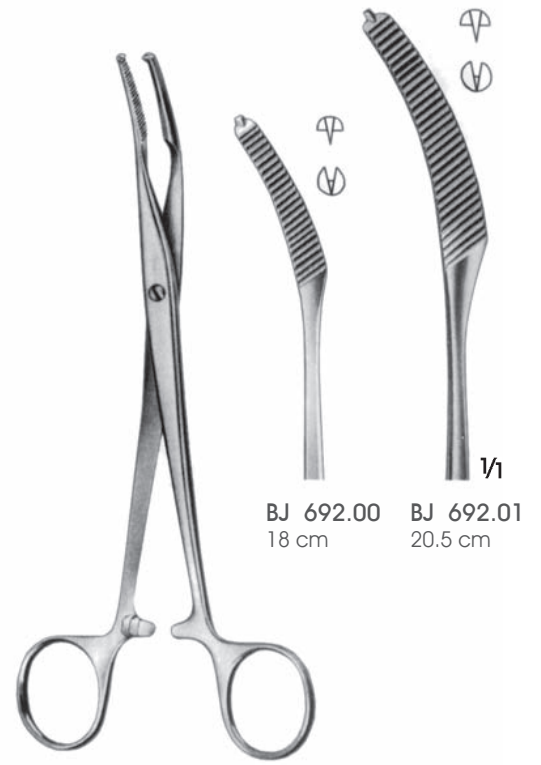

BJ 692.00 18 cm
BJ 692.01 20.5 cm



$\frac{1}{2}$
MIKULICZ
BJ 693.00
20.5 cm



$\frac{1}{2}$
MIKULICZ
BJ 694.00
20.5 cm

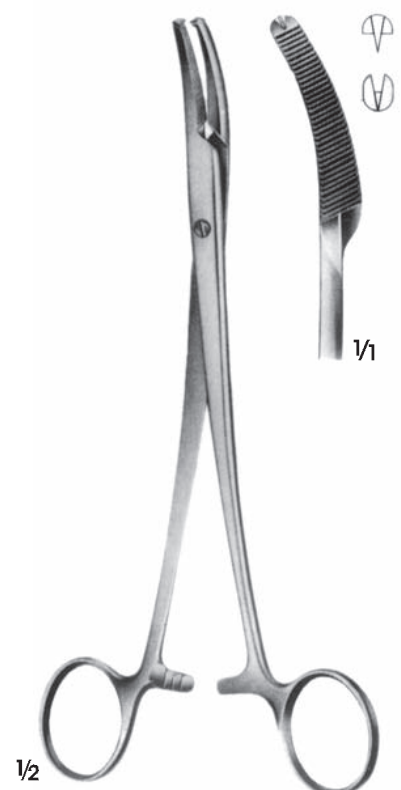

$\frac{1}{2}$
MIKULICZ
BJ 695.00
20 cm

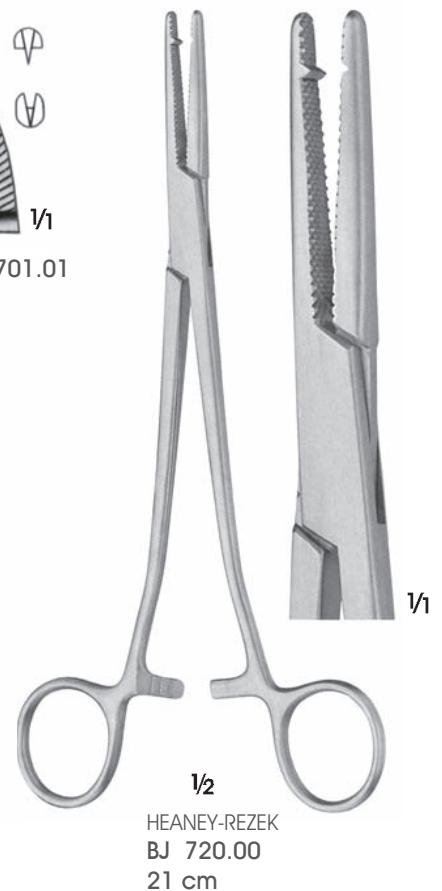
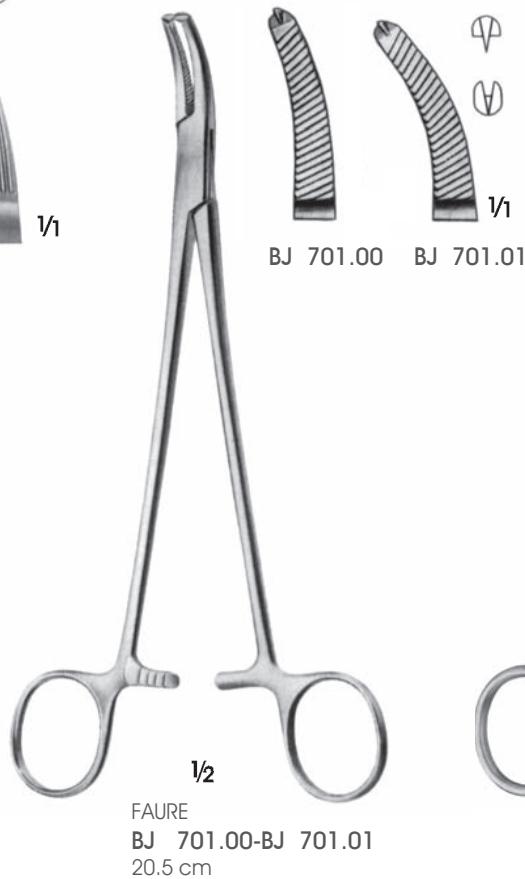

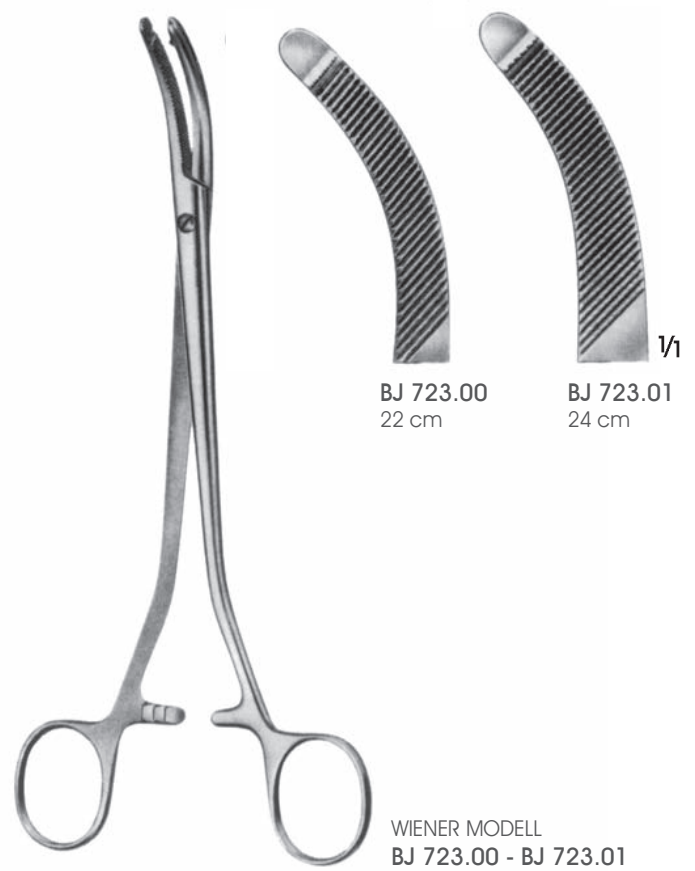
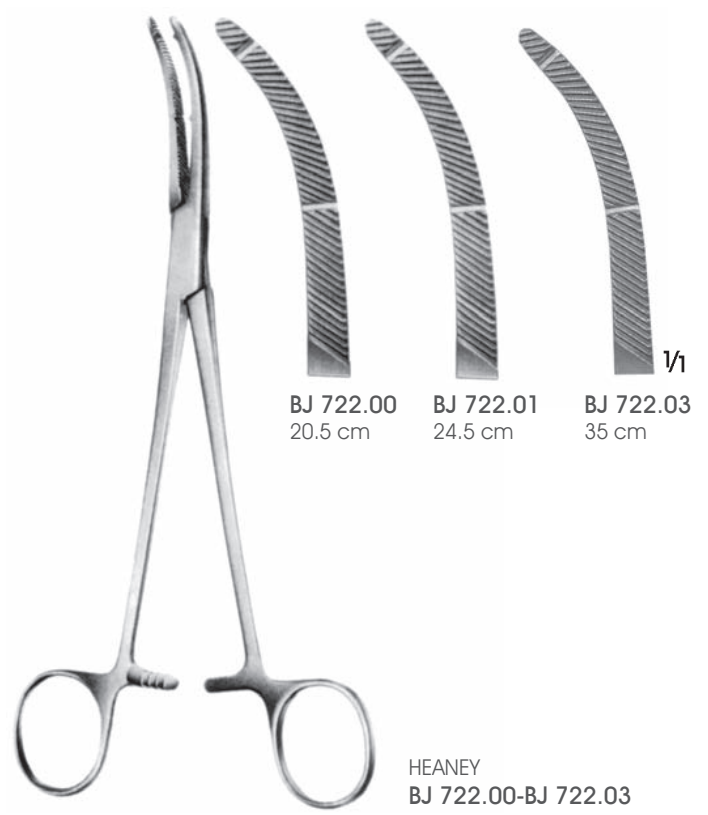

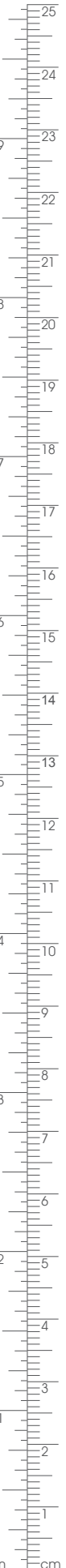
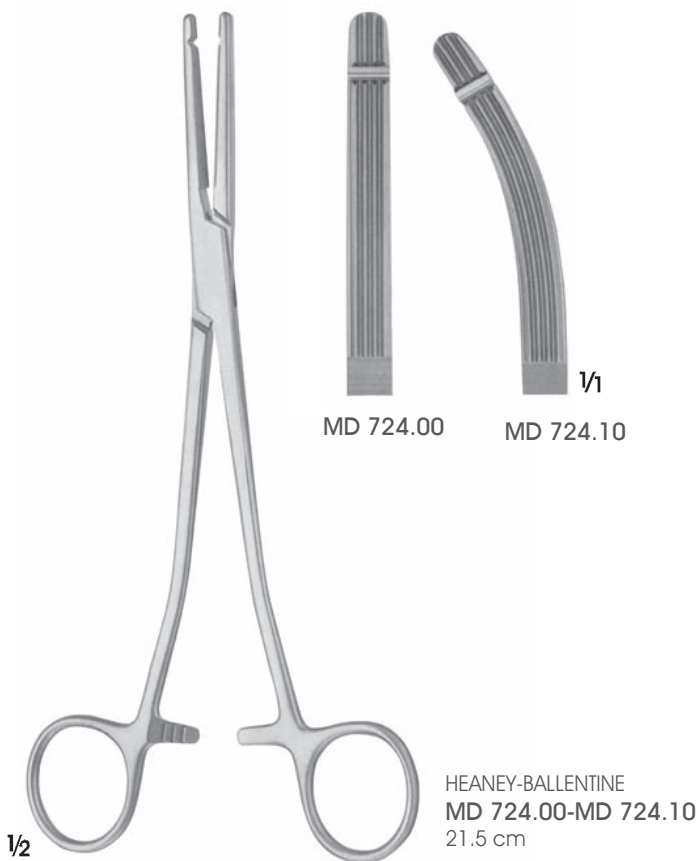
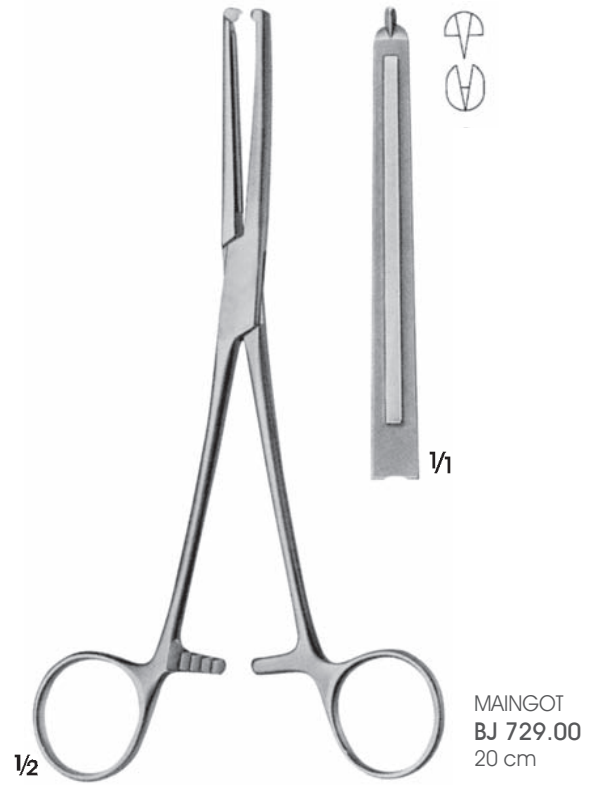

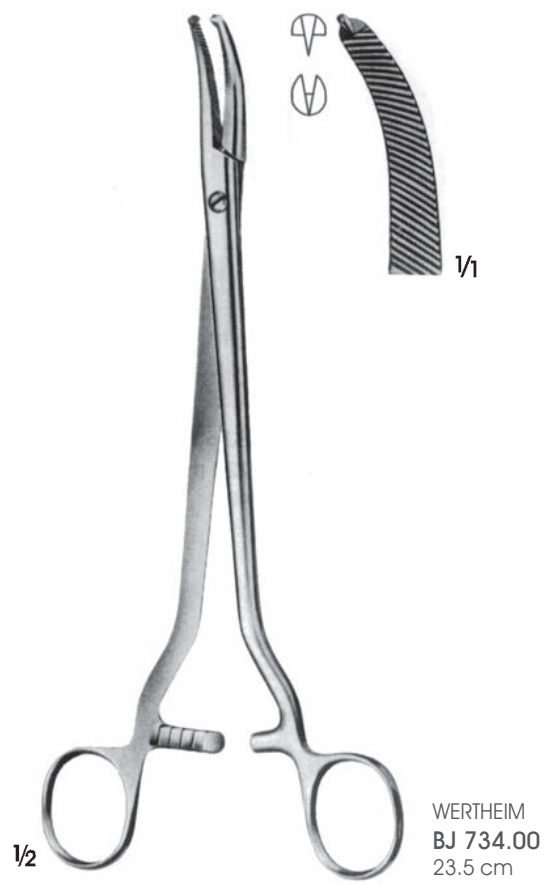

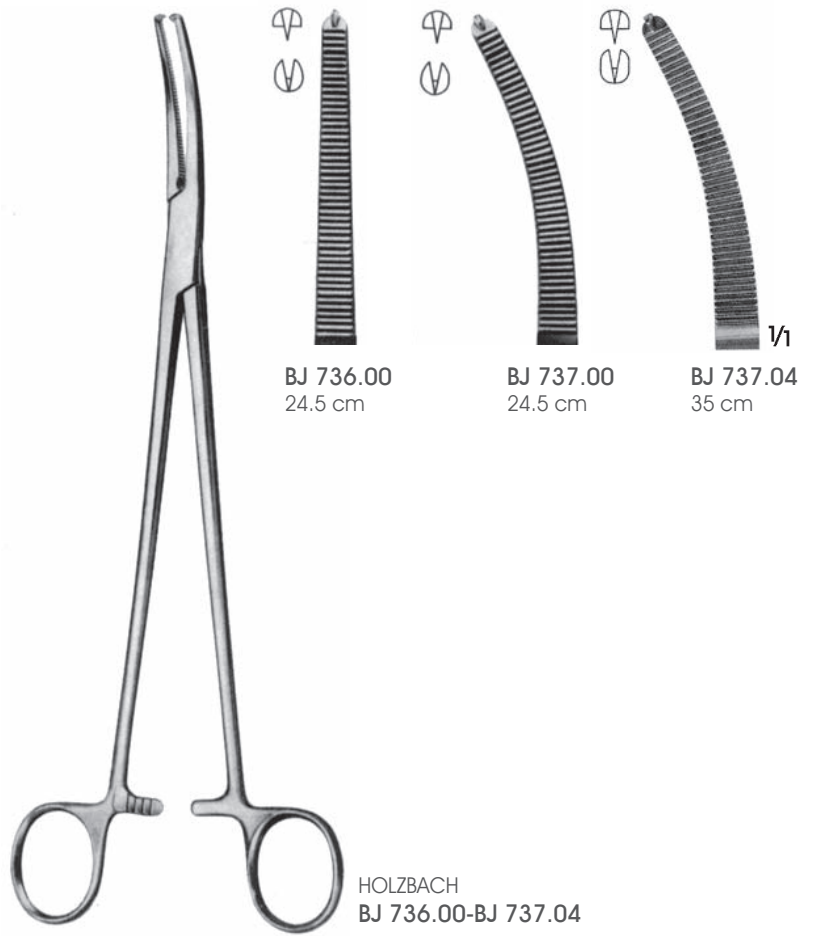
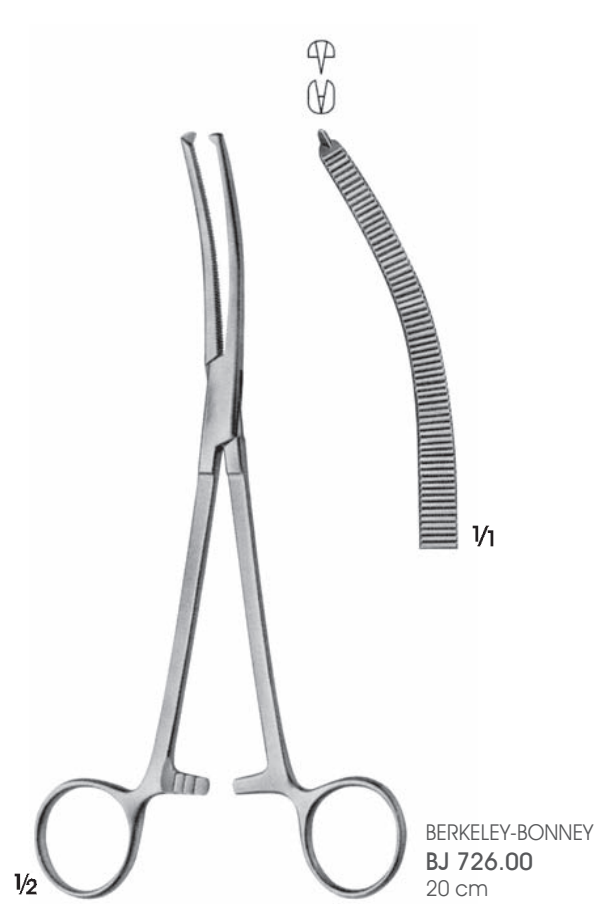
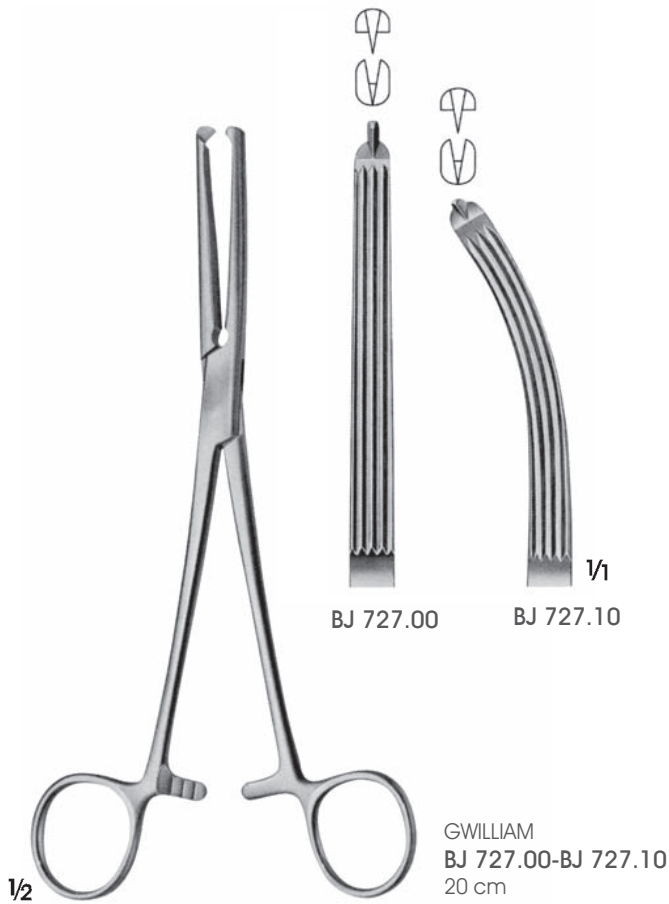

De Bakey Diş



Toothing De BAkey



BJ 750.00
22.5 cm



BJ 751.00
22 cm



BJ 752.00
21.5 cm



BJ 753.00
20.5 cm



HEANEY
BJ 750.00-BJ 753.00



BJ 754.00
25 cm



BJ 755.00
24.5 cm



BJ 756.00
24 cm



BJ 757.00
22 cm



WERTHEIM
BJ 754.00-BJ 757.00

De Bakey Diş



Toothing De BAkey

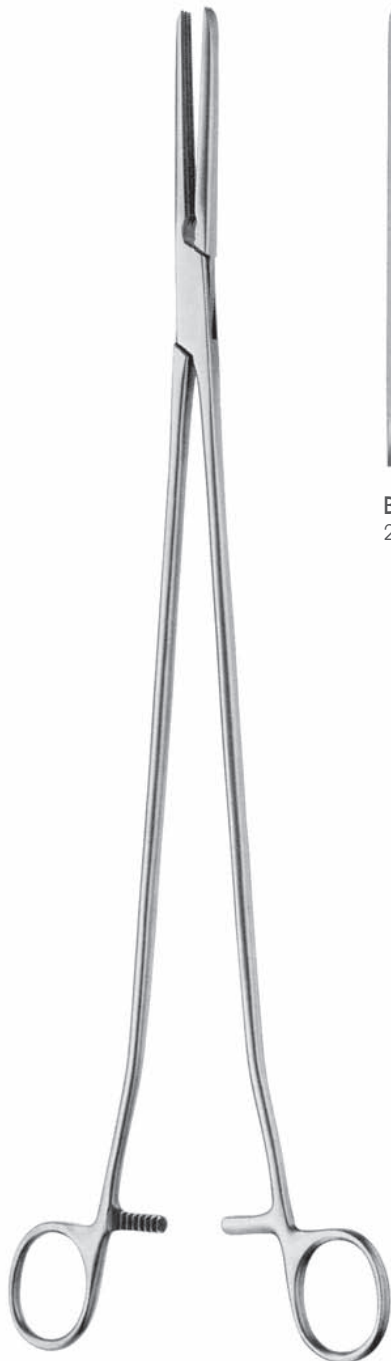

BJ 758.00
25 cm



BJ 758.04
35 cm



BJ 758.10
25 cm



BJ 758.11
35 cm

KIEBACK
BJ 758.00-BJ 758.04
BJ 758.10-BJ 758.11





1/2

WERTHEIM
BJ 760.00
25.5 cm



1/1



1/2

WERTHEIM
BJ 766.00
26 cm



1/1



BURKE
BJ 775.00-BJ 775.02
Parametrium pensi kısa ağız
Parametrium clamp, short jaw part

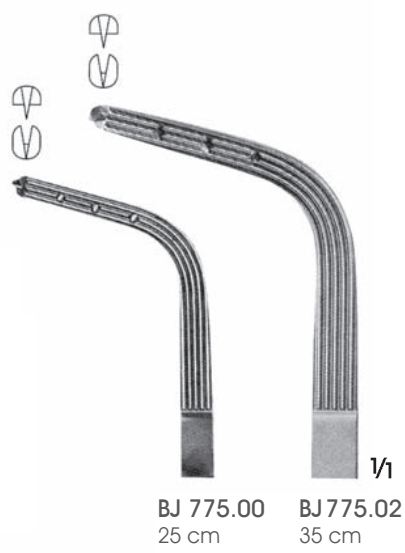

BURKE
BJ 776.00-BJ 776.02
Parametrium pensi uzun ağız
Parametrium clamp, long jaw part

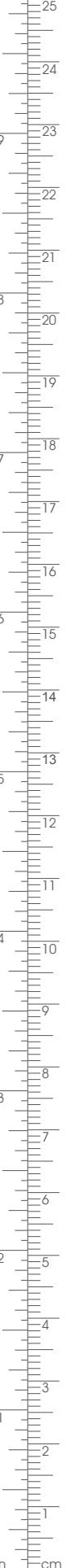

De Bakey Diş



Toothing De BAkey



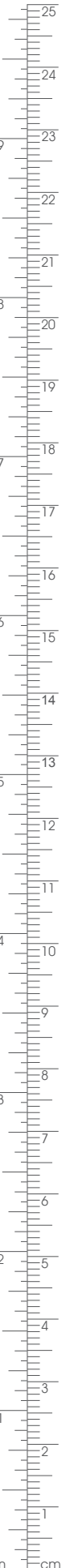

FB 204.00-FB 204.01
23 cm



WERTHEIM-CULLEN
BJ 771.00
21.5 cm

FB Kalp Damar Cerrahi
Cardiovascular and Thoracic Surgery



 **ARGENT**

De Bakey Diş



Toothing De BAkey



1/2

MOSQUITO
FB 400.00-FB 401.00
12.5 cm

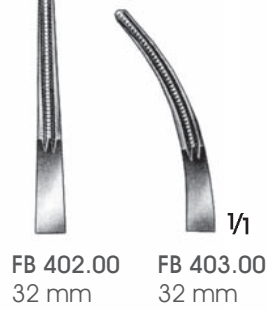

1/2

DE BAKEY-KELLY
FB 402.00-FB 403.00
14 cm

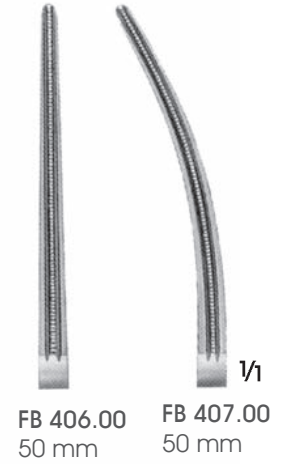

1/2

PEAN
FB 406.00-FB 407.00
15.5 cm



1/2

DE BAKEY-BAINBRIDGE
FB 408.00-FB 409.00
15.5 cm



1/2

FB 410.00-FB 411.00
16.5 cm

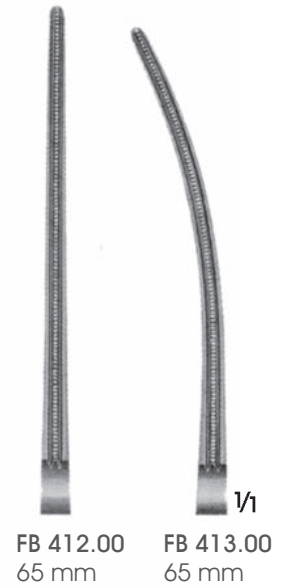

1/2

DE BAKEY-BAINBRIDGE
FB 412.00-FB 413.00
18 cm

De Bakey Diş



Toothing De BAkey



DE BAKEY-PEAN
FB 510.00 20 cm
FB 510.01 26.5 cm
FB 510.02 28 cm

DE BAKEY-PEAN
FB 511.00 20 cm
FB 511.01 26.5 cm
FB 511.02 27.5 cm

FB 510.00
60 mm

FB 510.01
89 mm

FB 510.02
99 mm

FB 511.00
60 mm

FB 511.01
89 mm

FB 511.02
99 mm

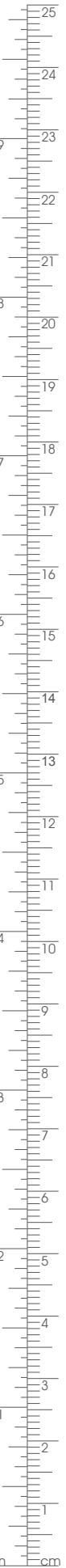

De Bakey Diş



Toothing De BAkey



1/2
DE BAKEY
FB 520.00
Düz/Straight
13 cm



1/2
DE BAKEY
FB 521.00
Eğri/Curved
12.5 cm

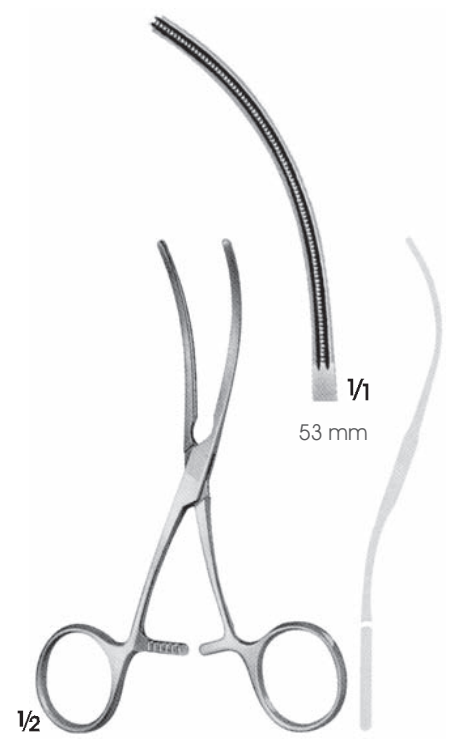

1/2
DE BAKEY
FB 522.00
S-Biçimli/S-shaped
12.5 cm



1/2
DE BAKEY
FB 524.00
90° açılı/Angled 90°
10.5 cm



1/2
NOON
FB 525.00
40° açılı/Angled 40°
11 cm

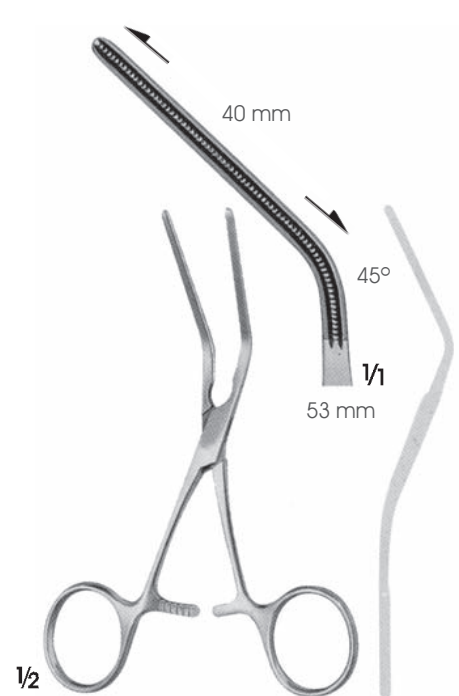

1/2
DE BAKEY
FB 523.00
45° açılı/Angled 45°
12.5 cm

De Bakey Diş



Toothing De BAkey



CASTANEDA
FB 530.00 12.5 cm
FB 531.00 12 cm
FB 532.00 12 cm
FB 533.00 10.5 cm

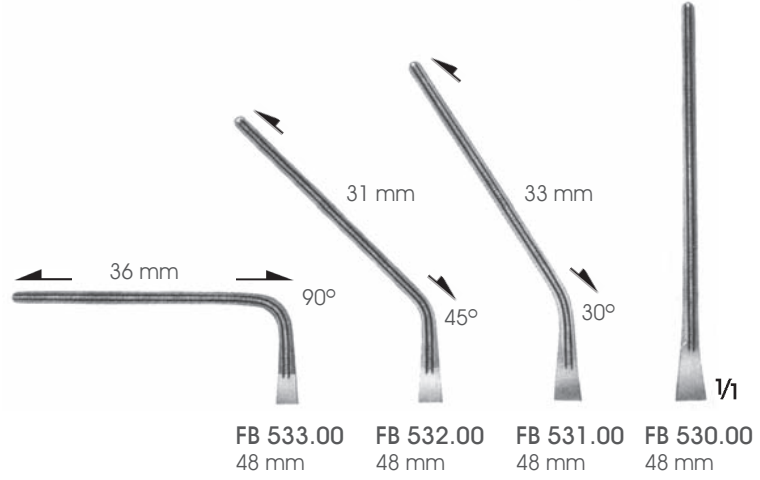

FB 533.00 48 mm
FB 532.00 48 mm
FB 531.00 48 mm
FB 530.00 48 mm



1/2

CASTANEDA
FB 540.00-FB 540.03
15.5 cm

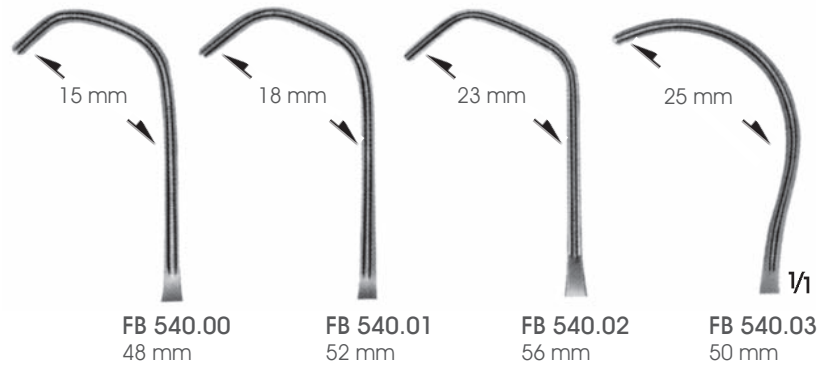

FB 540.00 48 mm
FB 540.01 52 mm
FB 540.02 56 mm
FB 540.03 50 mm



De Bakey Diş



Toothing De BAkey



DE BAKEY
FB 545.00-FB 545.01

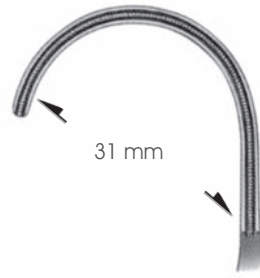

31 mm

FB 545.00
16 cm

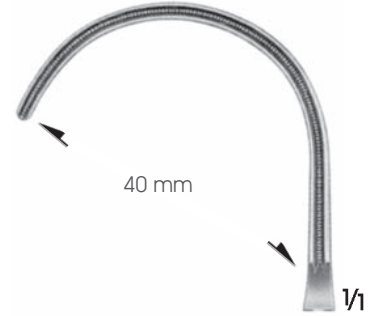

40 mm

FB 545.01
17 cm



COOLEY
FB 550.00-FB 552.00

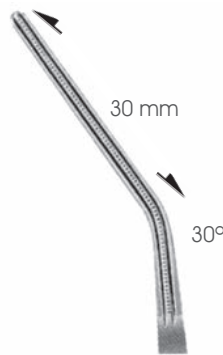

30 mm

30°

FB 552.00
16.5 cm

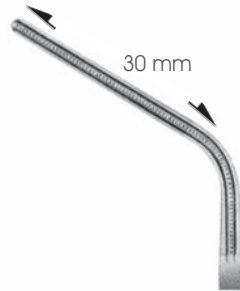

30 mm

60°

FB 551.00
16 cm

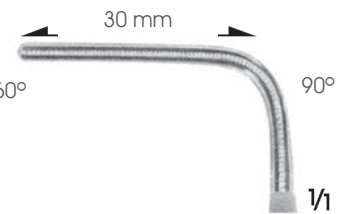

30 mm

90°

FB 550.00
15 cm

De Bakey Diş



Toothing De BAkey



DERRA
FB 554.00-FB 554.02



FB 554.00
17 cm

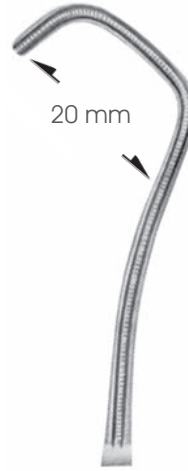

FB 554.01
17 cm

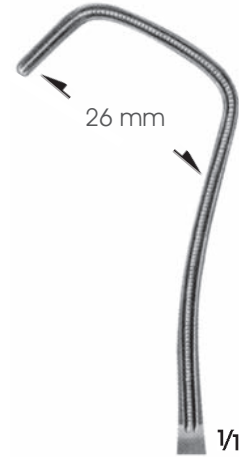

FB 554.02
17.5 cm

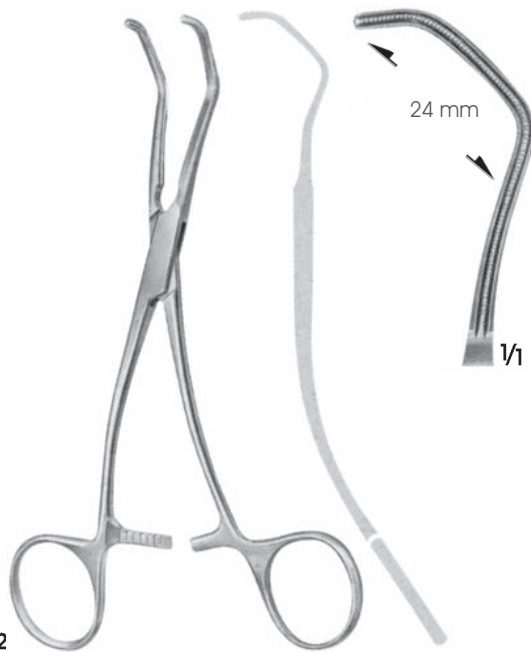

1/2

COOLEY
FB 556.00
16 cm

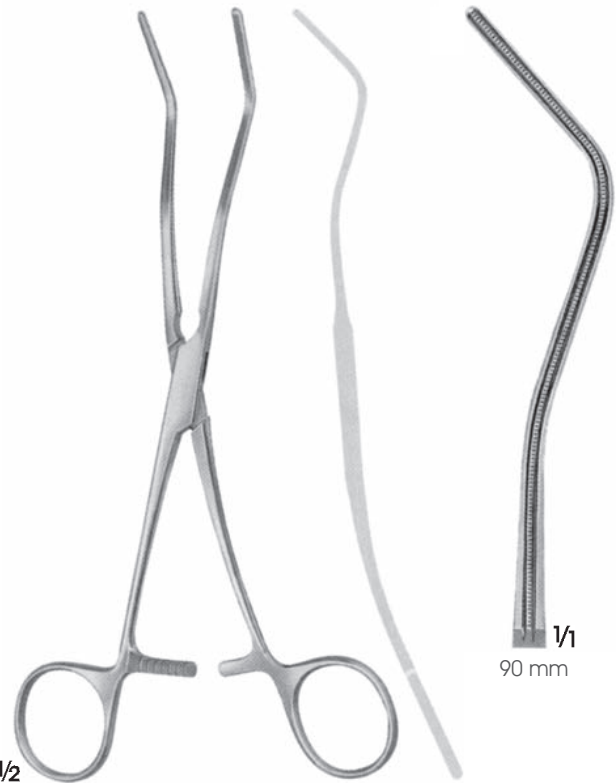

1/2

COOLEY
FB 562.00
20 cm

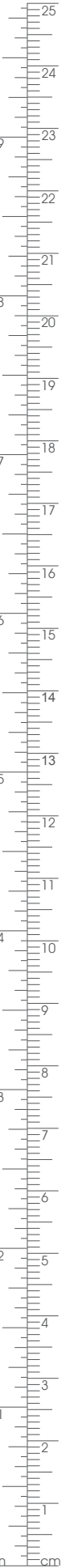

De Bakey Diş



Toothing De BAkey



GLOVER
FB 452.00 19.5 cm
FB 452.01 21 cm

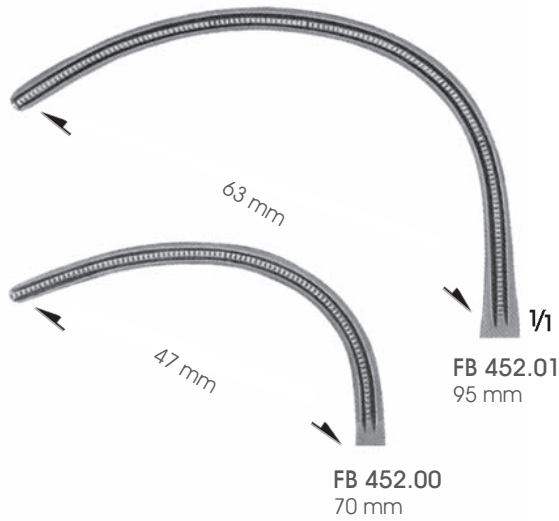

GLOVER
FB 453.00
22 cm



GLOVER
FB 454.00
21.5 cm

65 mm
1/1



GLOVER
FB 455.00
24.5 cm

86 mm
1/1

De Bakey Diş



Toothing De BAkey



DE BAKEY-BECK
FB 564.00 20.5 cm
FB 564.01 21 cm

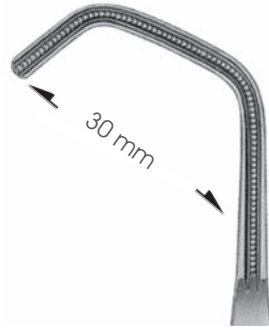

FB 564.00
65 mm

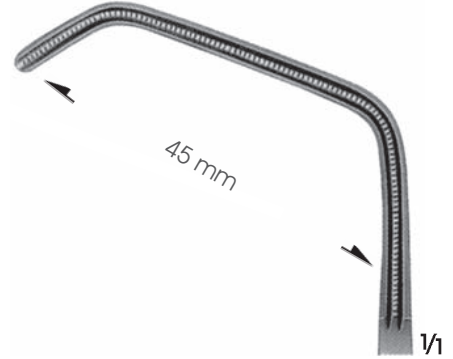

FB 564.01
80 mm



DE BAKEY-HARKEN
FB 566.00 25.5 cm
FB 567.00 24.5 cm
FB 568.00 24.5 cm
FB 569.00 24.5 cm



FB 566.00
86 mm



FB 567.00
86 mm



FB 568.00
86 mm

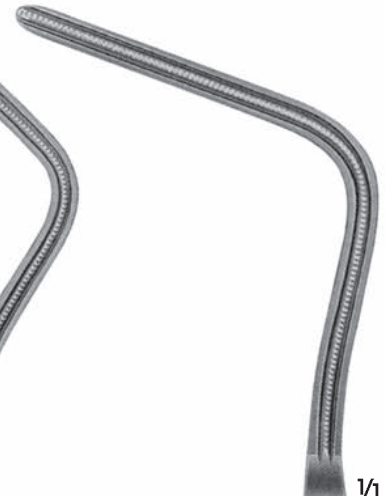

FB 569.00
86 mm

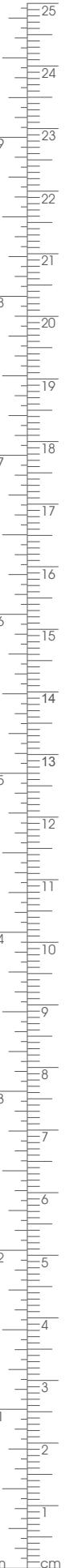

De Bakey Diş



Toothing De BAkey

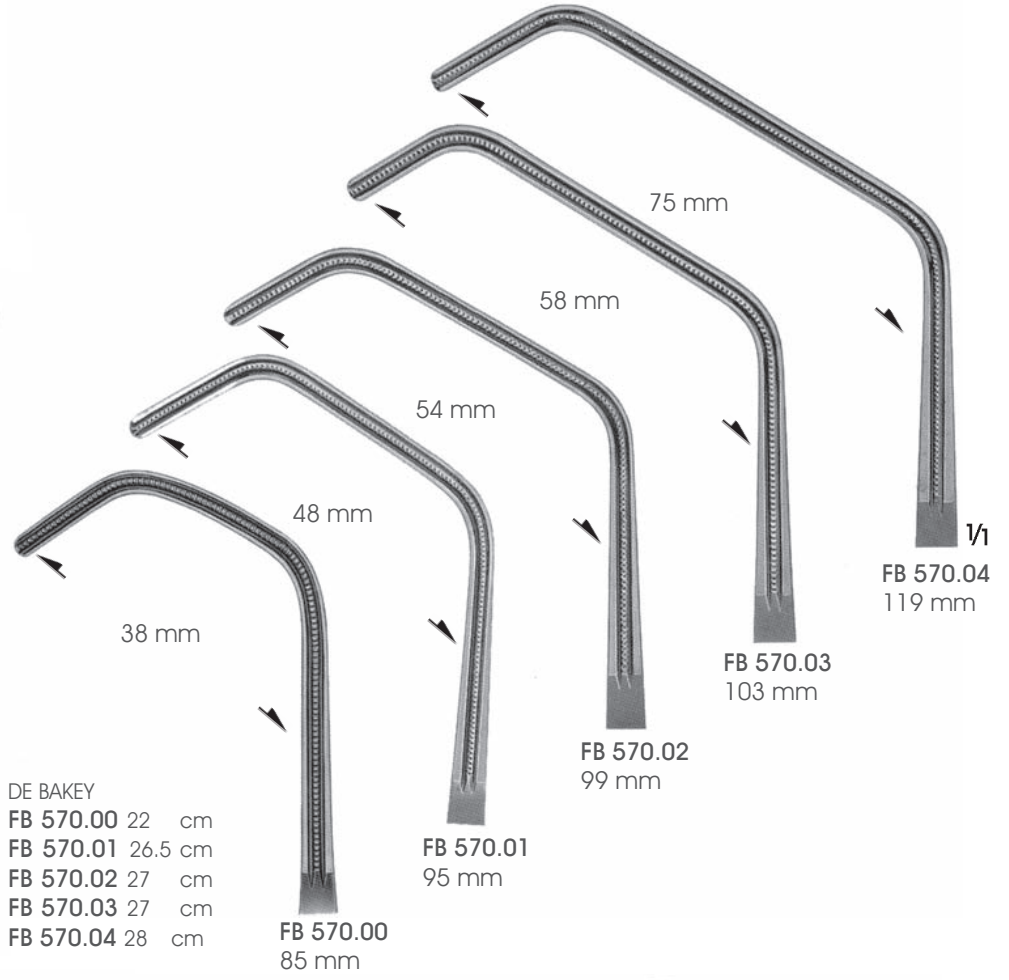

DE BAKEY
FB 570.00 22 cm
FB 570.01 26.5 cm
FB 570.02 27 cm
FB 570.03 27 cm
FB 570.04 28 cm

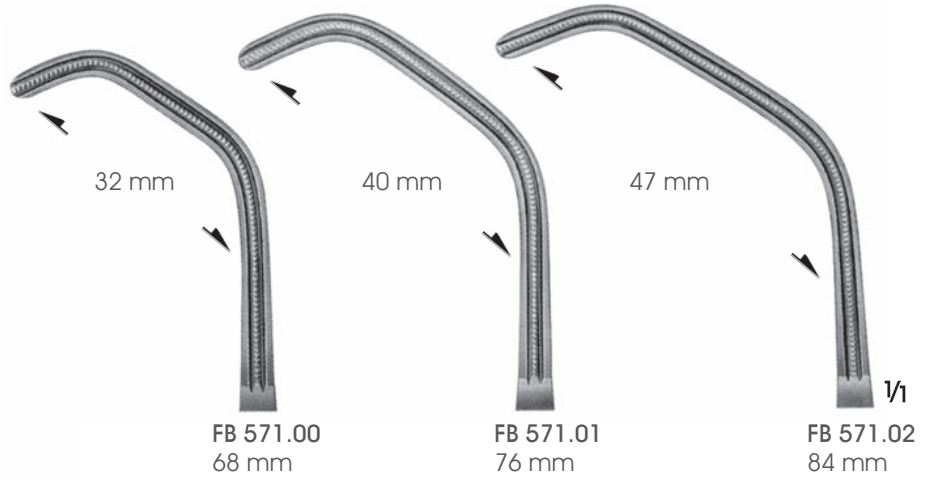

DE BAKEY-SATINSKY
FB 571.00 23.5 cm
FB 571.01 24 cm
FB 571.02 24.5 cm

De Bakey Diş



Toothing De BAKEY

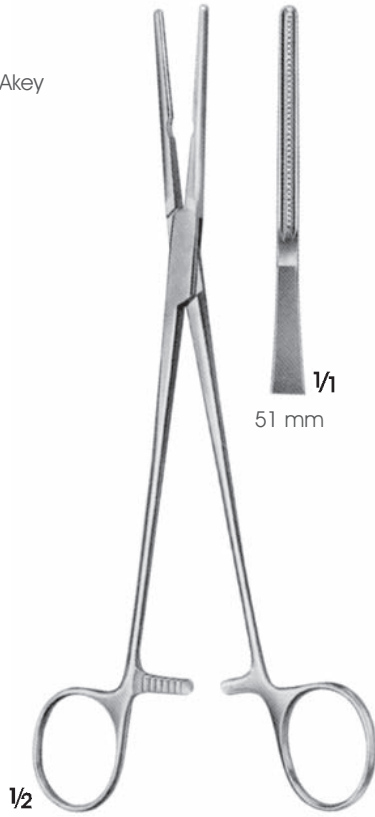

DE BAKEY
FB 422.00
21 cm

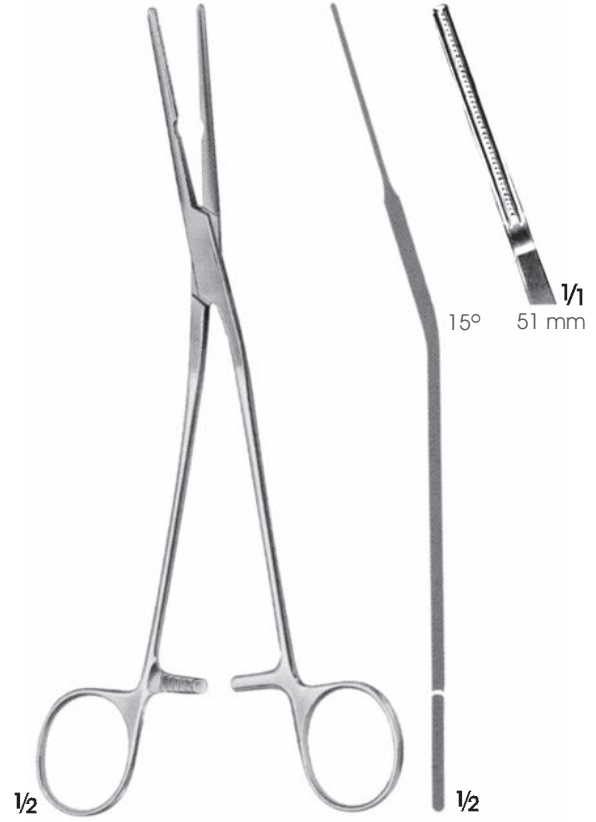

DE BAKEY
FB 423.00
21 cm



DE BAKEY
FB 450.00
16 cm

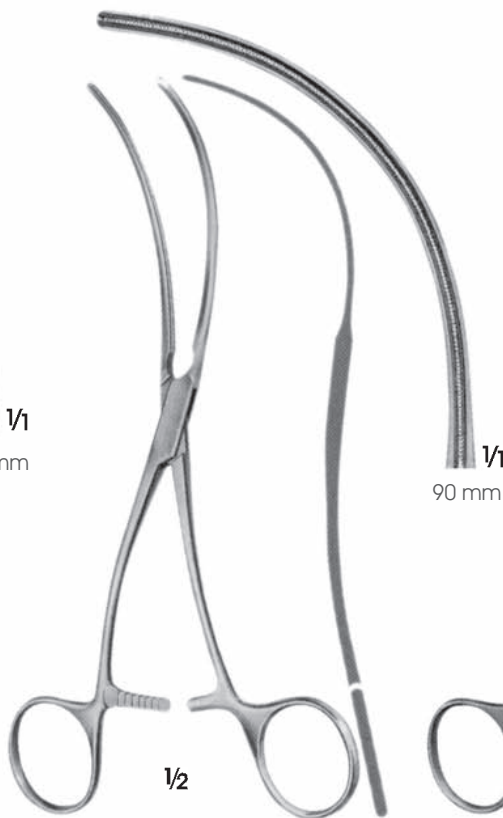

DE BAKEY
FB 451.00
19 cm

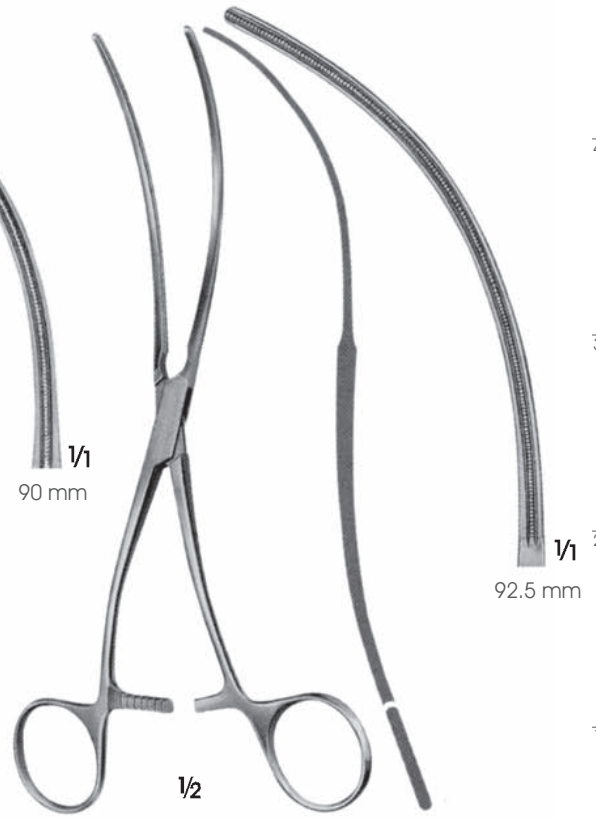

DE BAKEY
FB 451.01
20 cm



De Bakey Diş



Toothing De BAkey

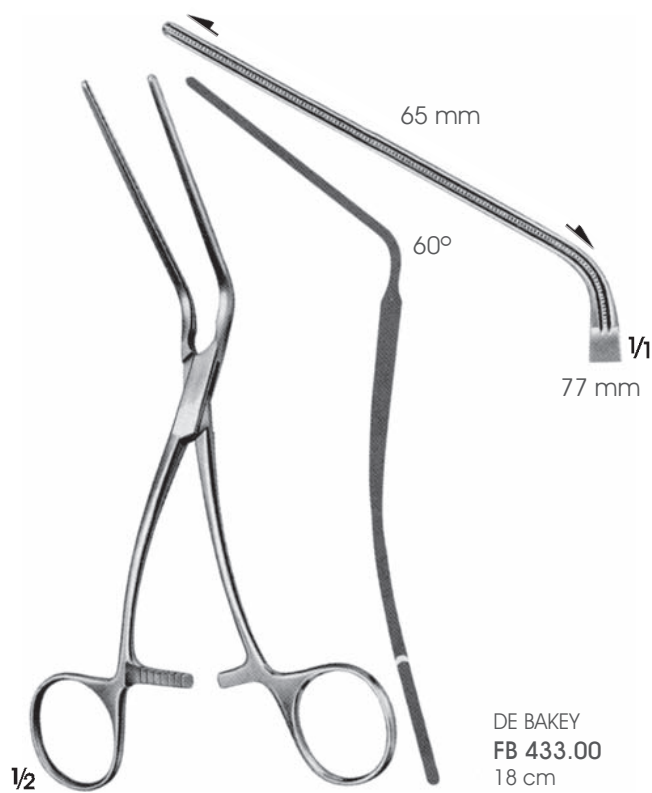

De Bakey Diş



Toothing De BAkey

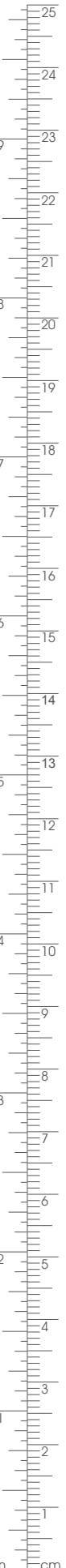
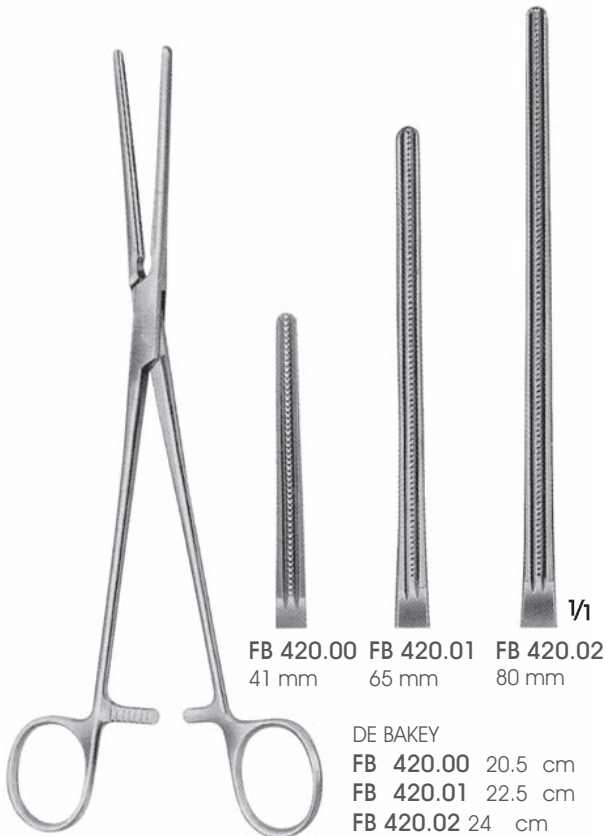
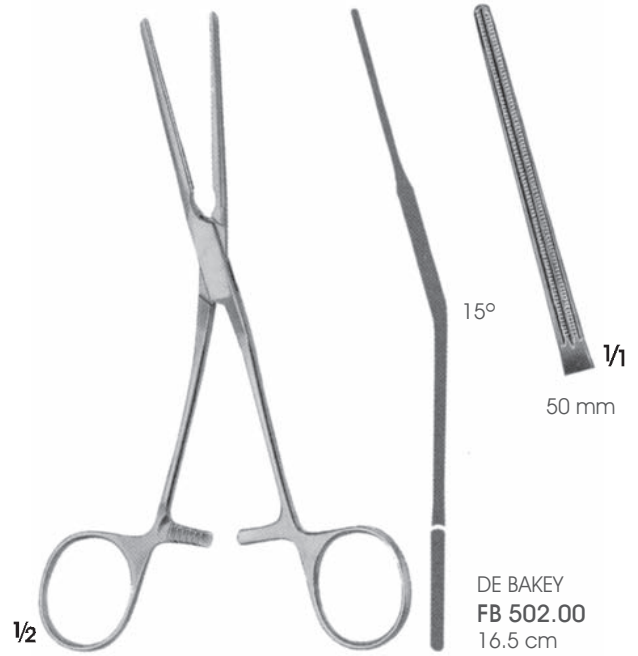
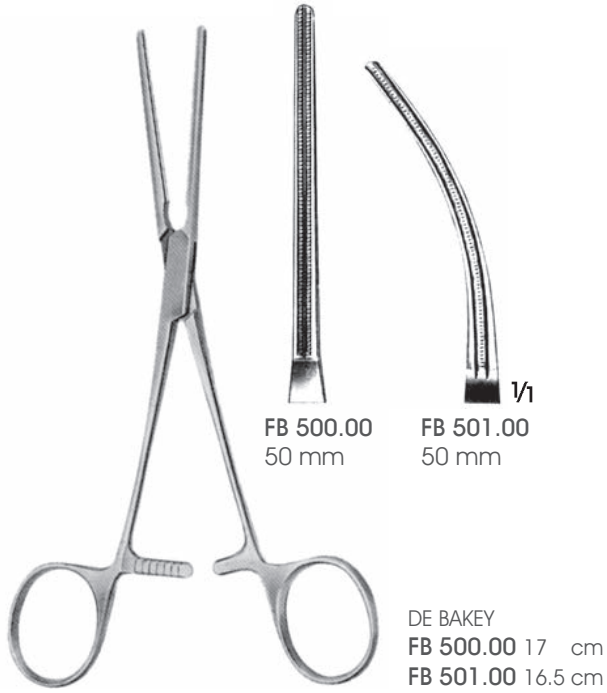

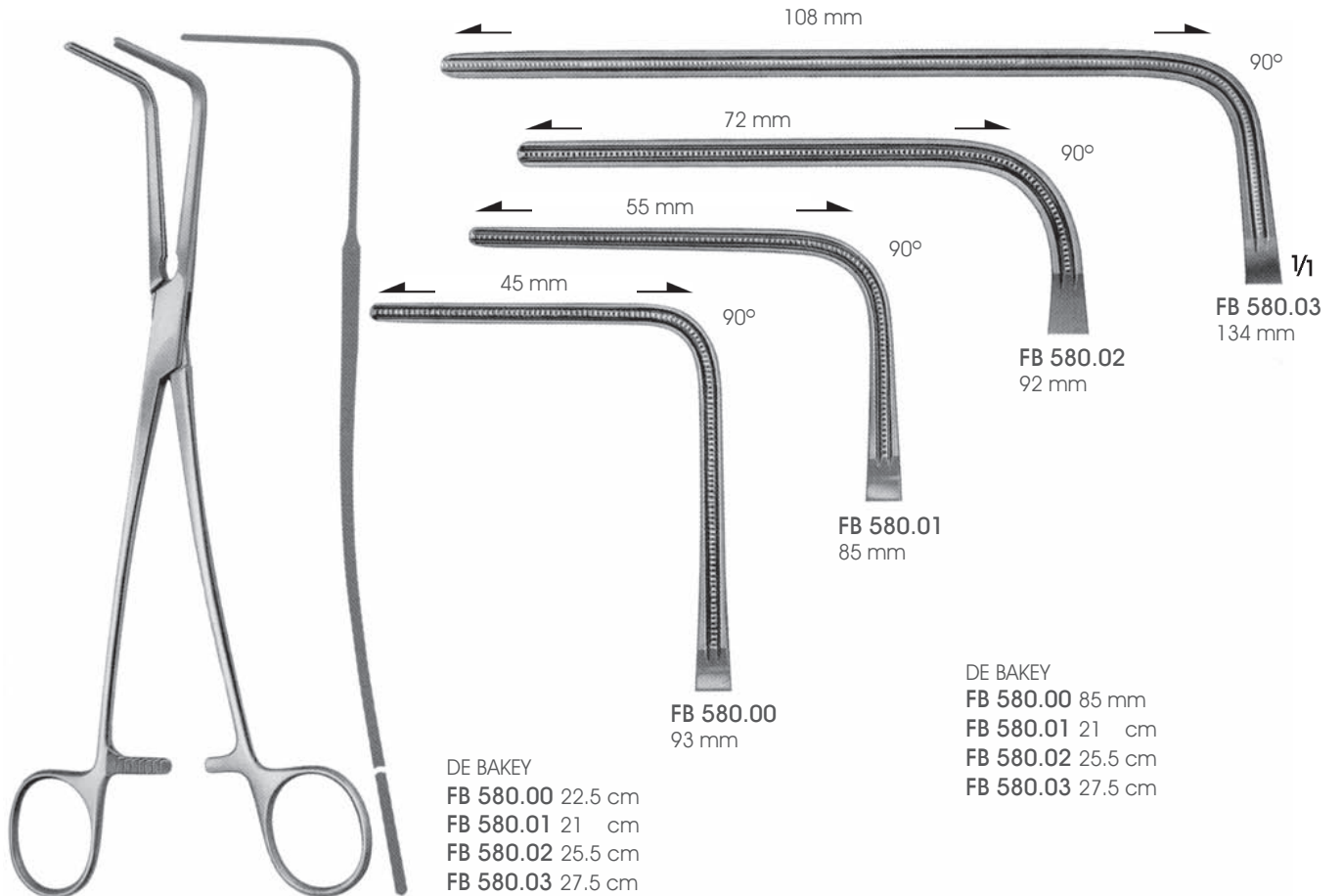
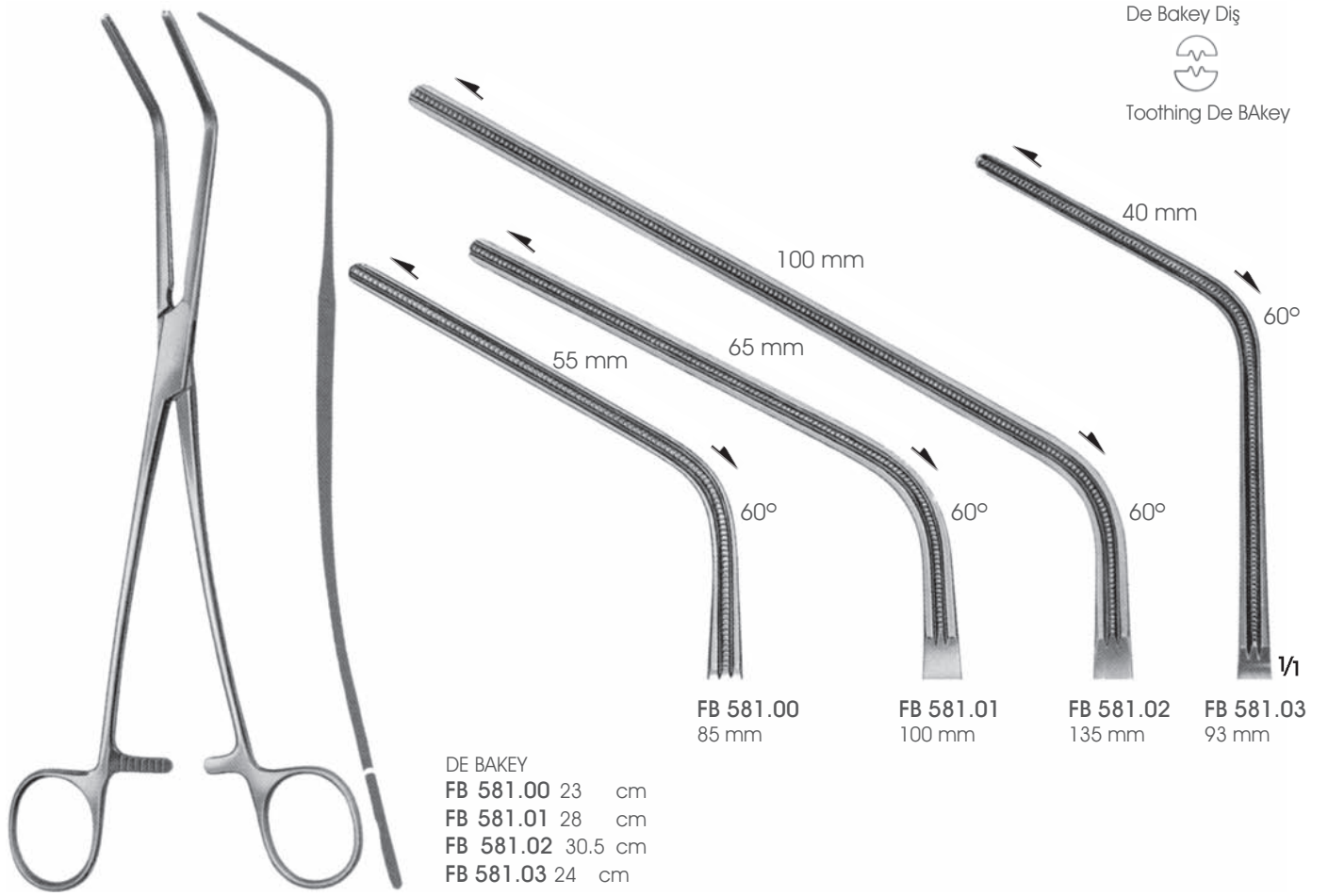

De Bakey Diş



Toothing De BAkey

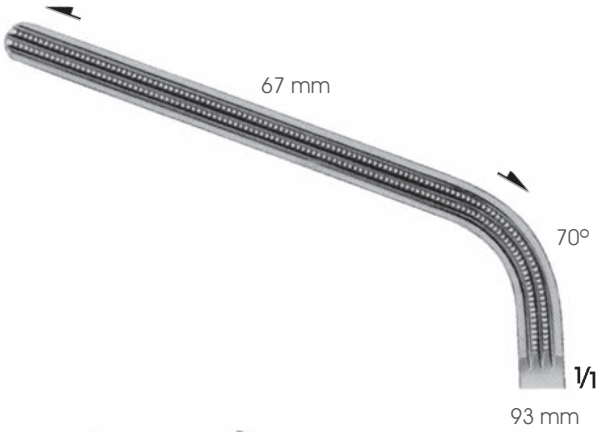
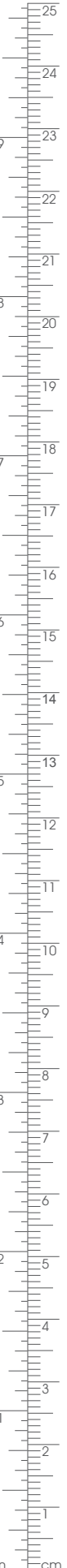

MORRIS
FB 460.00
17.5 cm



DE BAKEY
FB 461.00
24 cm

De Bakey Diş



Toothing De BAkey



FB 477.00
70 mm

FB 477.01
75 mm

FB 477.02
85 mm

1/1

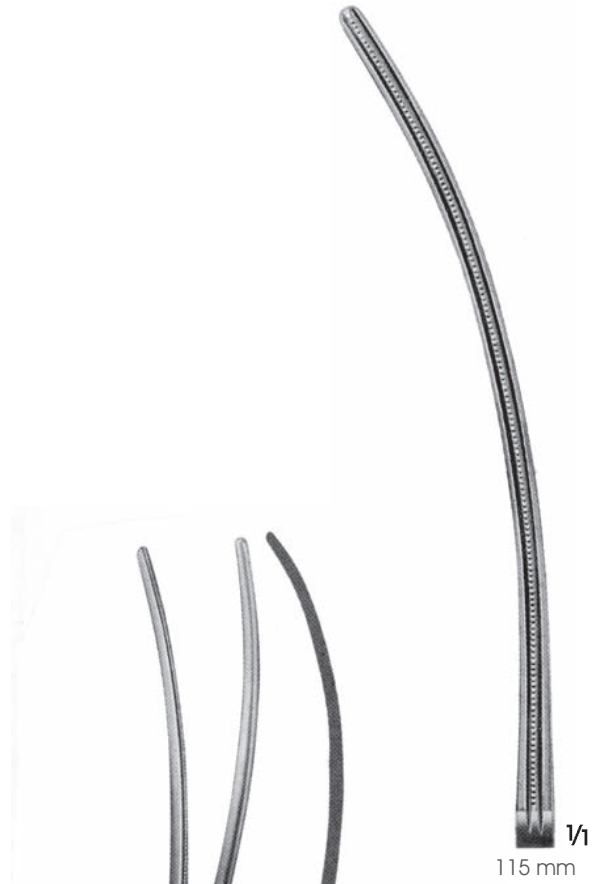

115 mm

1/1



DE BAKEY
FB 477.00 25.5 cm
FB 477.01 26.5 cm
FB 477.02 28 cm

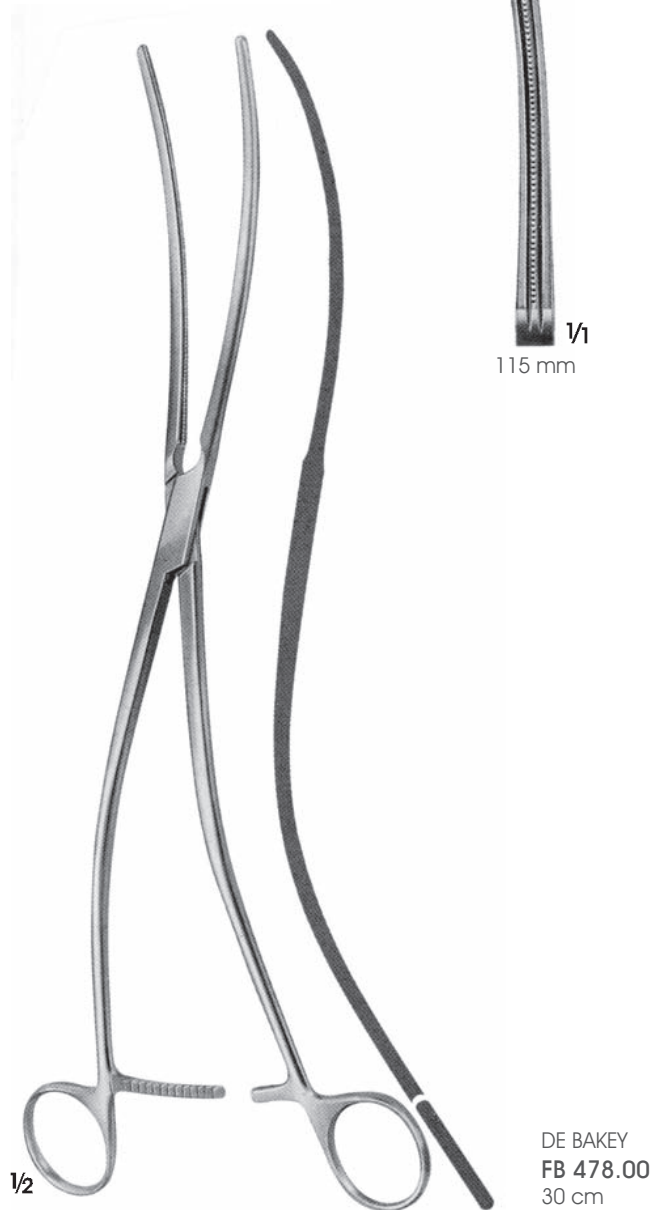

DE BAKEY
FB 478.00
30 cm

1/2

De Bakey Diş



Toothing De BAkey

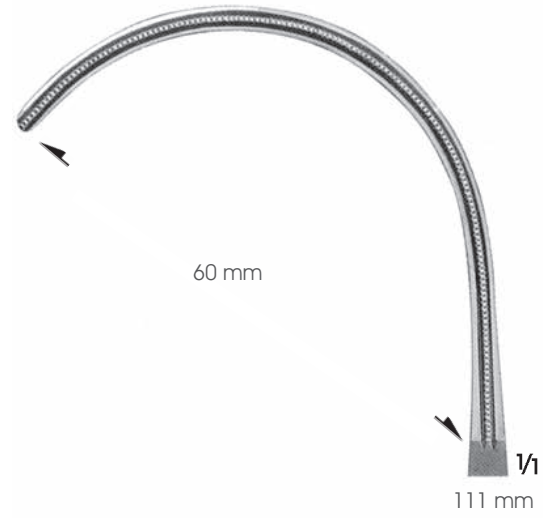
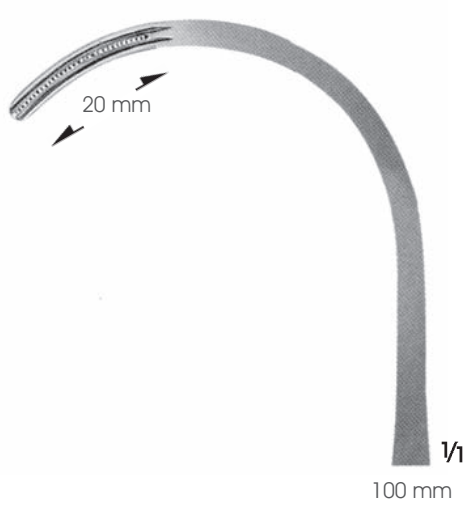

DE BAKEY
FB 480.00
26.5 cm



DE BAKEY
FB 481.00
27 cm

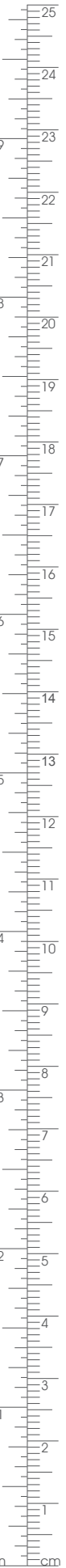

De Bakey Diş



Toothing De BAkey

2 x 3 sıra diş



2 x 3 teeth rows

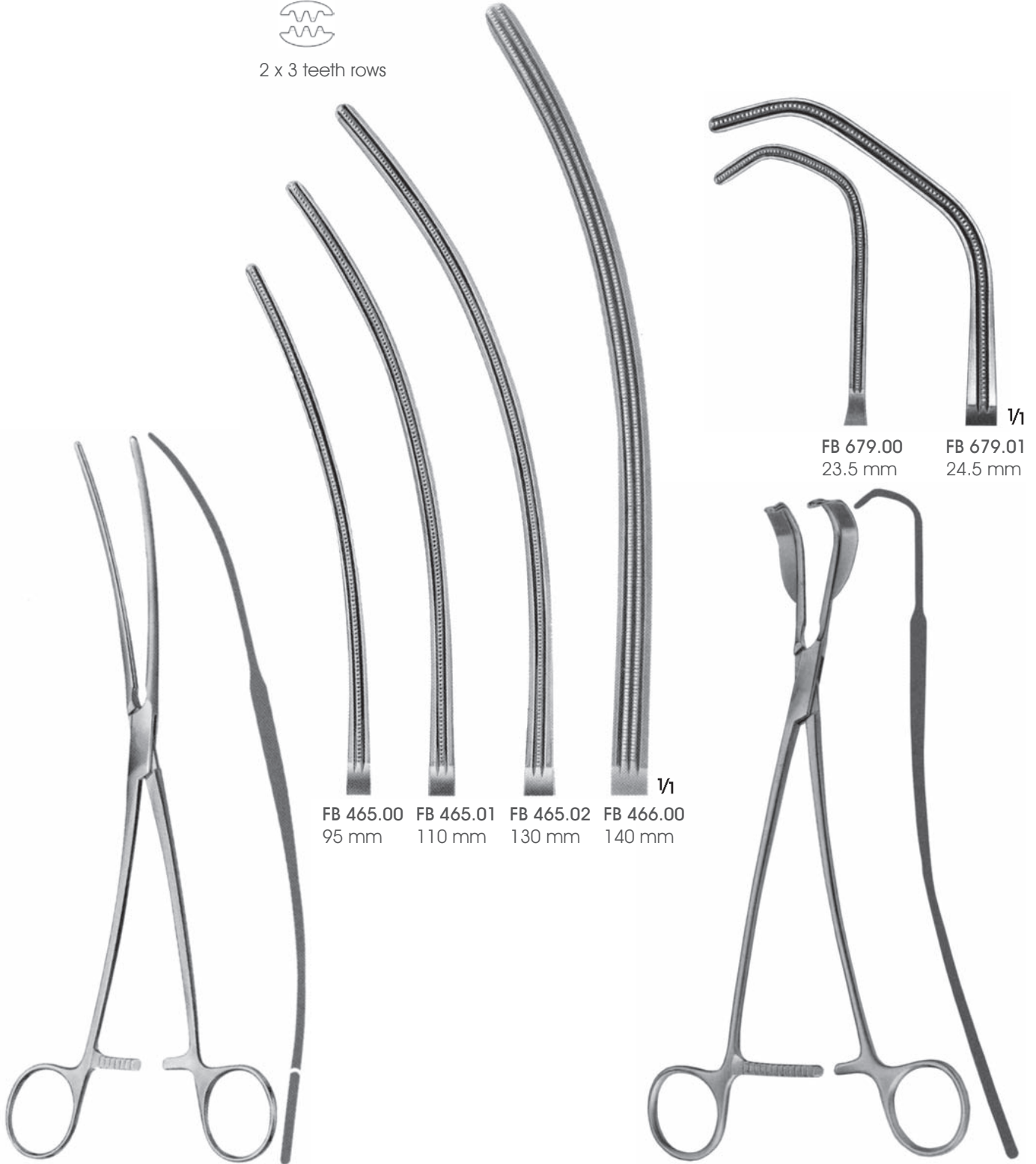

DE BAKEY
FB 465.00 25 cm
FB 465.01 30 cm
FB 465.02 31.5 cm
FB 466.00 33 cm

ALLENBERG
FB 679.00-FB 679.01
Anastomoz sırasına ince dokuların
ayrılmasında kullanılan bıçaklı ayırıcılar
With retraction blades for retraction
of soft tissue during the anastomosis

De Bakey Diş



Toothing De BAkey

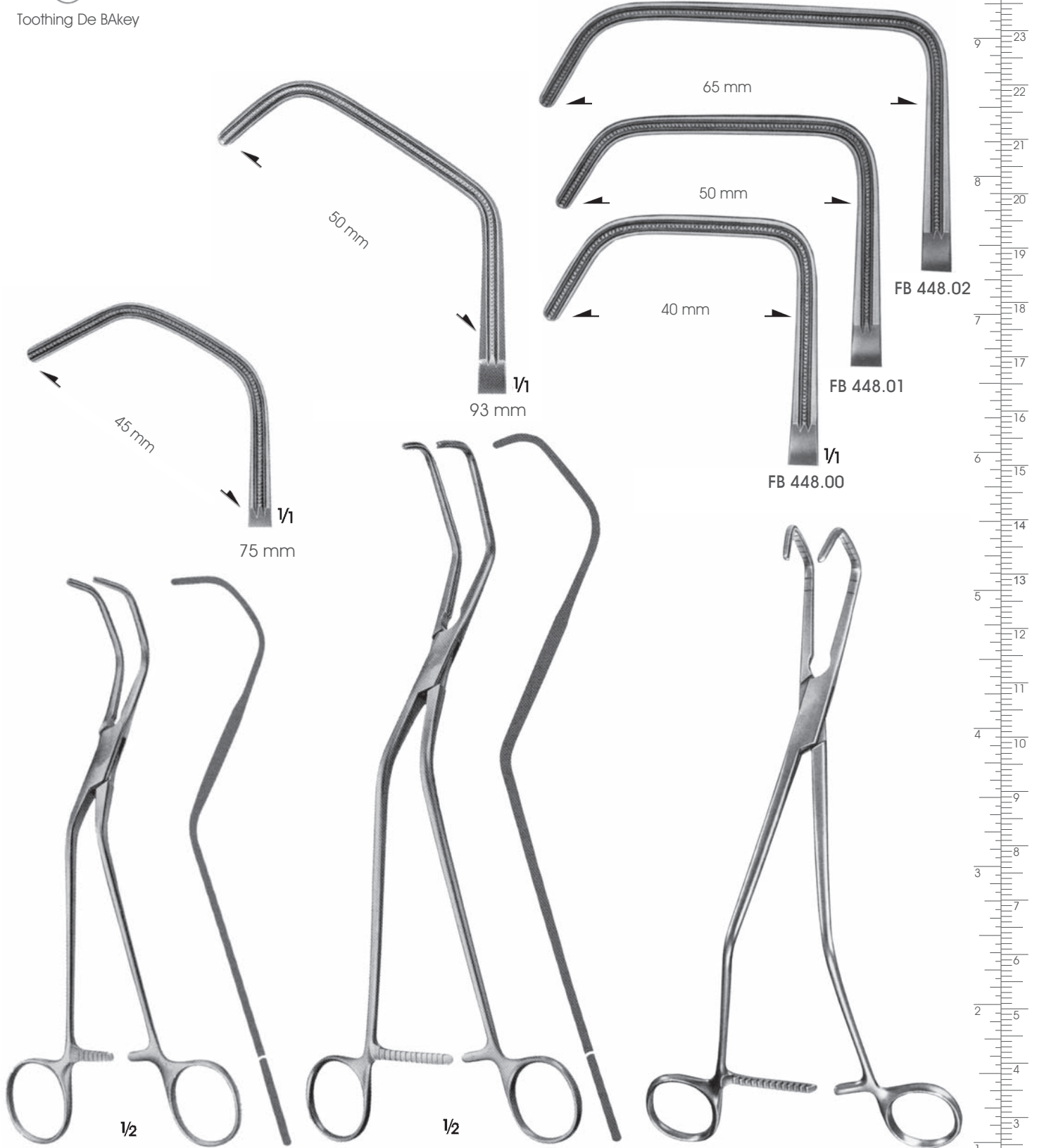

DIETRICH
FB 488.00
Aort klempl/Aorta clamp
21 cm

OCHSNER
FB 489.00
Aort klempl/Aorta clamp
26 cm

HOPT
FB 448.00 23 cm
FB 448.01 23.5 cm
FB 448.02 24.5 cm
Böbrek ve Pankreas klempleri
Kidney and Pankreas clamps

De Bakey Diş



Toothing De BAkey

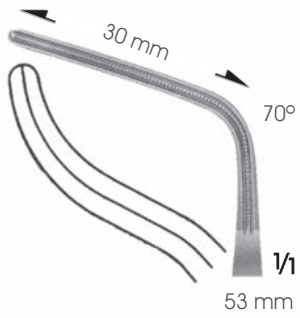

SUBRAMANIAN
FB 576.00
15.5 cm

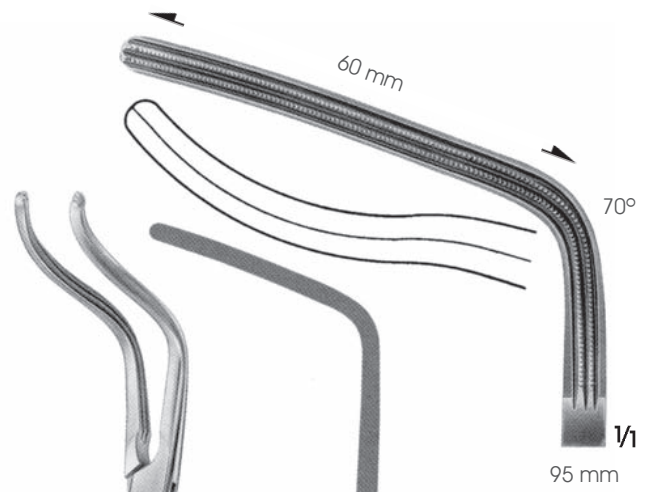

DE BAKEY
FB 577.00
26.5 cm

De Bakey Diş



Toothing De BAkey

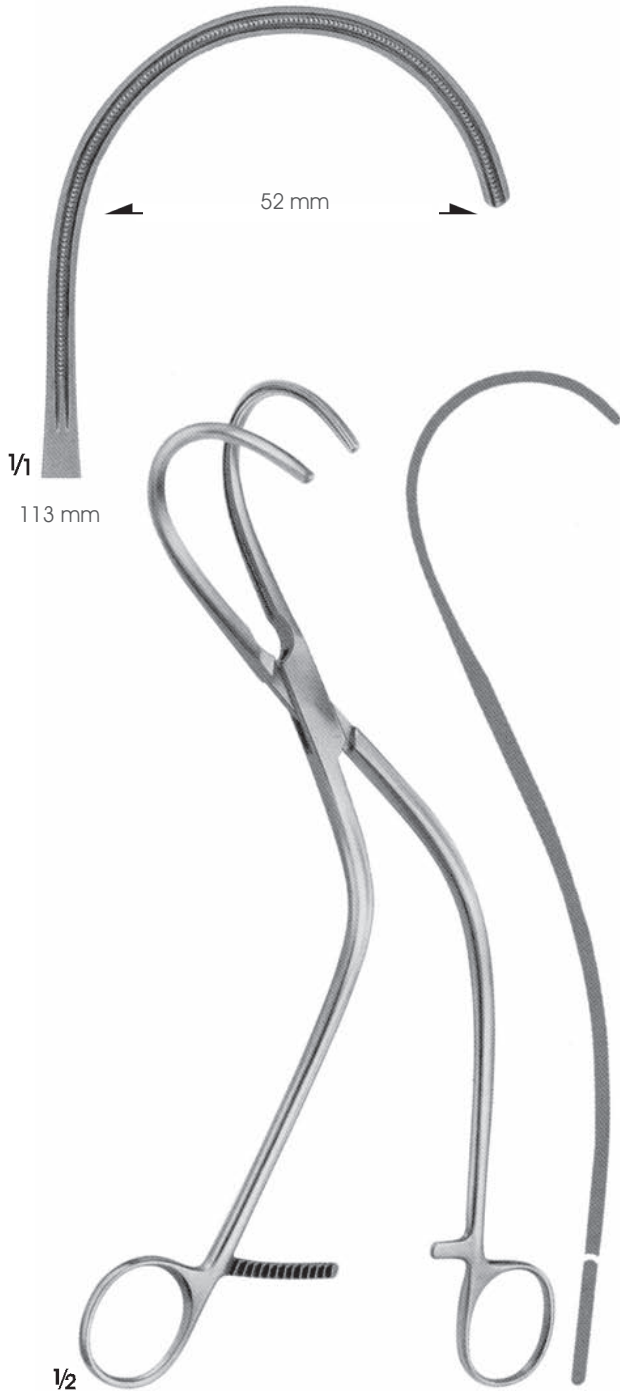

WEBER
FB 484.00
Sol/Left
26 cm



WEBER
FB 485.00
Sağ/Right
26 cm



De Bakey Diş



Toothing De BAkey

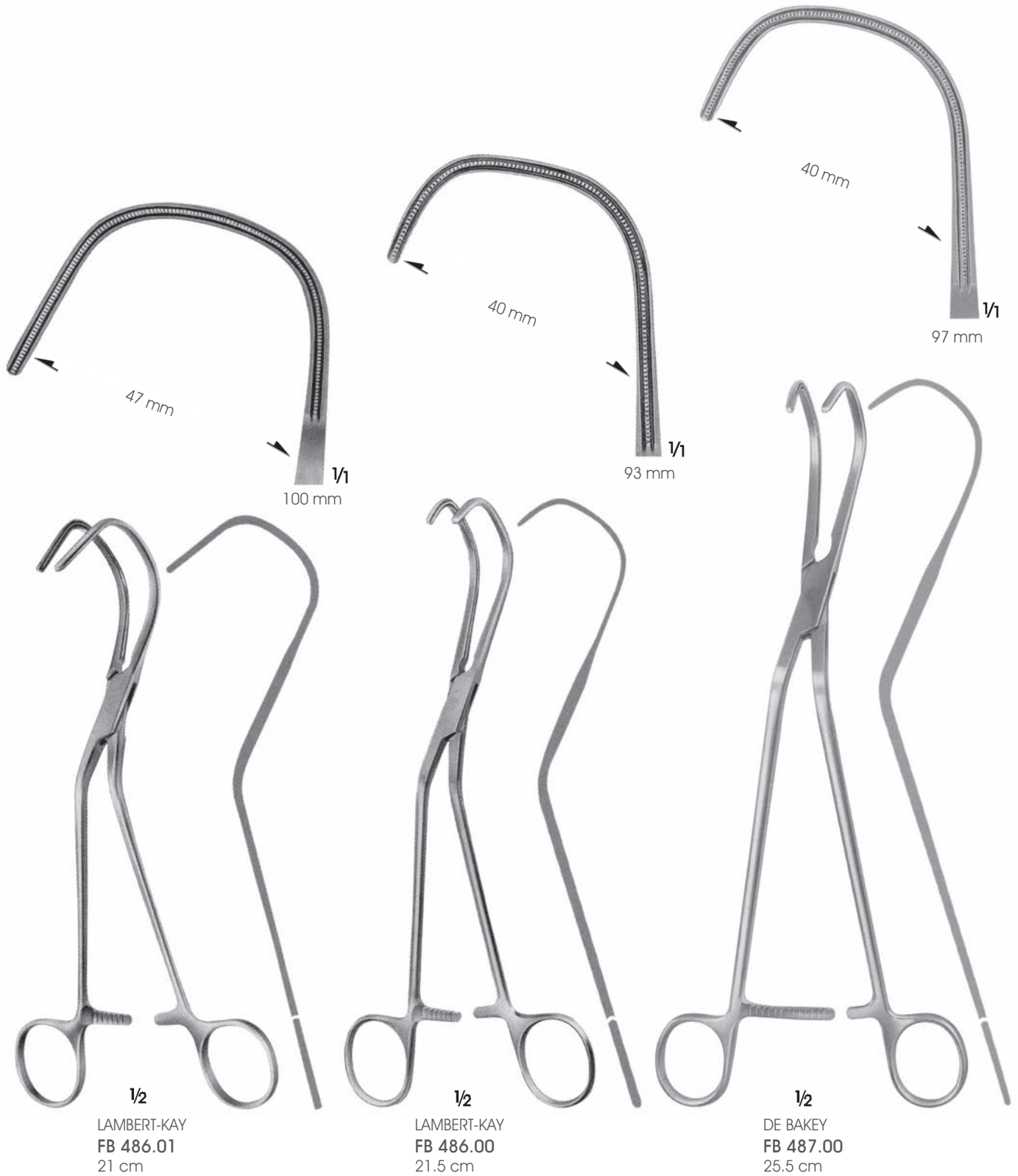

De Bakey Diş



Toothing De BAkey

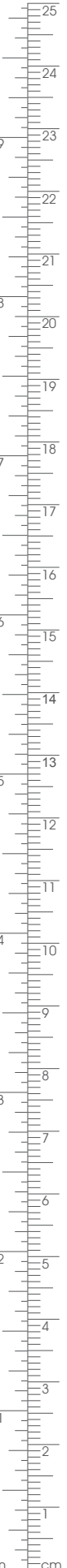

LEES
FB 572.00
22 cm



LEES
FB 573.00
24.5 cm



DE BAKEY-MC QUIGG-MIXTER
FB 444.00
21 cm

De Bakey Diş



Toothing De BAkey



GREGORY
FB 435.03 57 mm
FB 435.04 62 mm
 Profunda klempler
 Profunda clamps 20 cm



FB 440.00 51 mm
FB 440.01 75 mm

DE BAKEY
FB 440.00 21 cm
FB 440.01 23 cm



FB 442.00 77 mm
FB 442.01 80 mm

DE BAKEY
FB 442.00 19 cm
FB 442.01 23 cm



1/2

DE BAKEY
FB 445.00 24 cm

De Bakey Diş



Toothing De BAkey



DE BAKEY-RUMEL
FB 447.00
25 cm



DE BAKEY-RUMEL
FB 446.00
24.5 cm



DE BAKEY-MIXTER
FB 449.00
28.5 cm



De Bakey Diş



Toothing De BAkey



FB 204.01
80 mm



FB 204.00
60 mm



FB 200.00
78 mm

FB 200.01
88 mm

FB 200.02
98 mm



FB 204.00-FB 204.01
Bronş pensler
Bronchus forceps
23 cm

1/2



DICK
FB 200.00 25.5 cm
FB 200.01 26.5 cm
FB 200.02 27.5 cm
Anastomoz klempler
Anastomosis clamps

De BAkey Diş
2 x 3 sıra diş



2 x 3 teeth rows
Toothing De BAkey

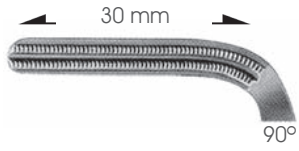

FC 770.00
38 mm

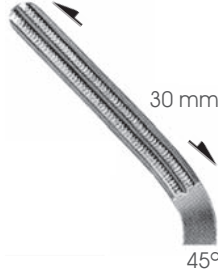

FC 771.00
38 mm

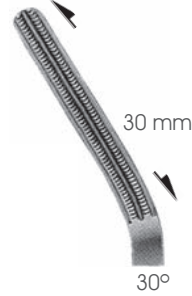

FC 772.00
38 mm

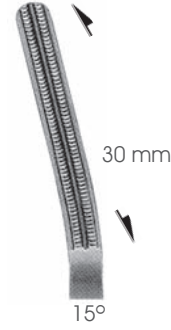

FC 773.00
38 mm

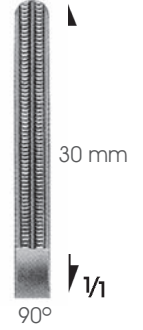

FC 774.00
38 mm

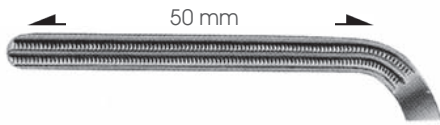

FC 770.01
58 mm

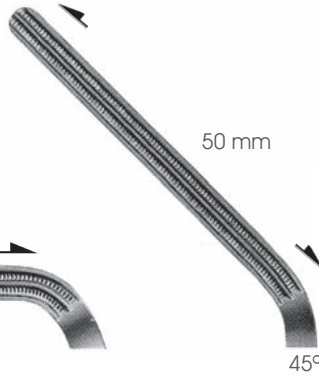

FC 771.01
58 mm

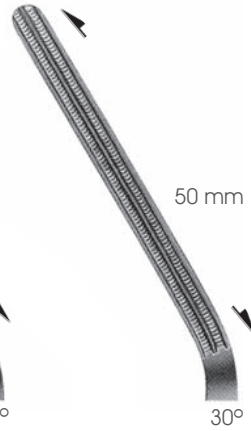

FC 772.01
58 mm

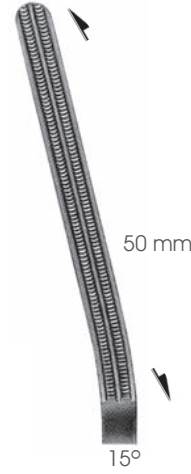

FC 773.01
58 mm

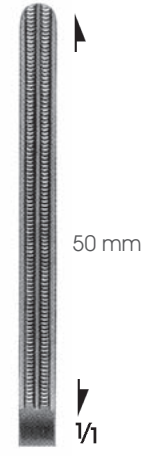

FC 774.01
58 mm



DARDIK

FC 770.00 13 cm
FC 771.00 14,5 cm
FC 772.00 15 cm
FC 773.00 15 cm
FC 774.00 15 cm

DARDIK

FC 770.01 13,5 cm
FC 771.01 16 cm
FC 772.01 17 cm
FC 773.01 17 cm
FC 774.01 17 cm



Cooley Diş



Toothing Cooley

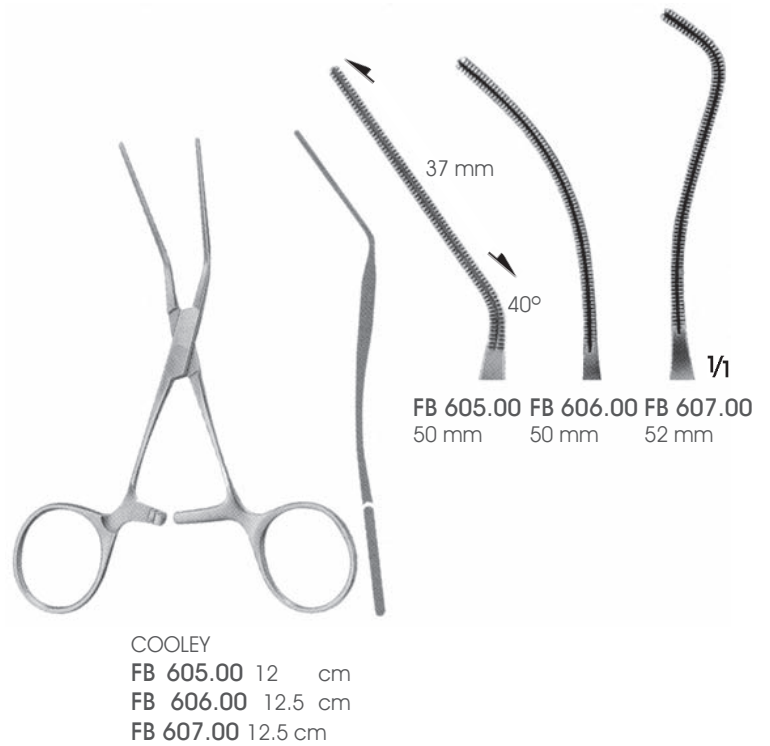
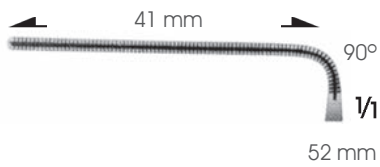
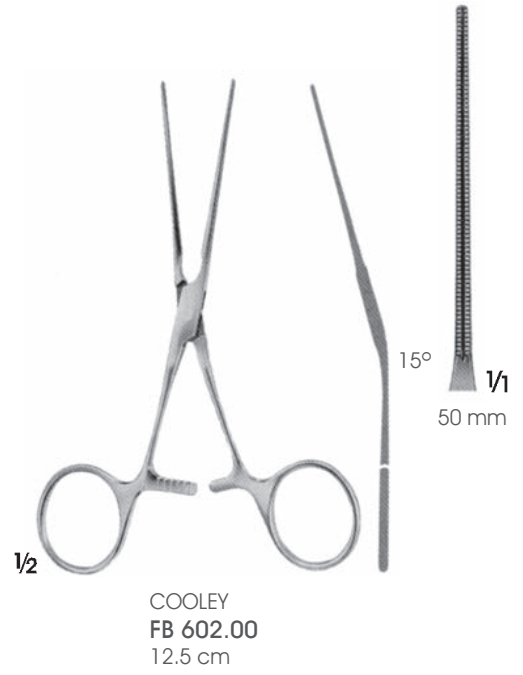
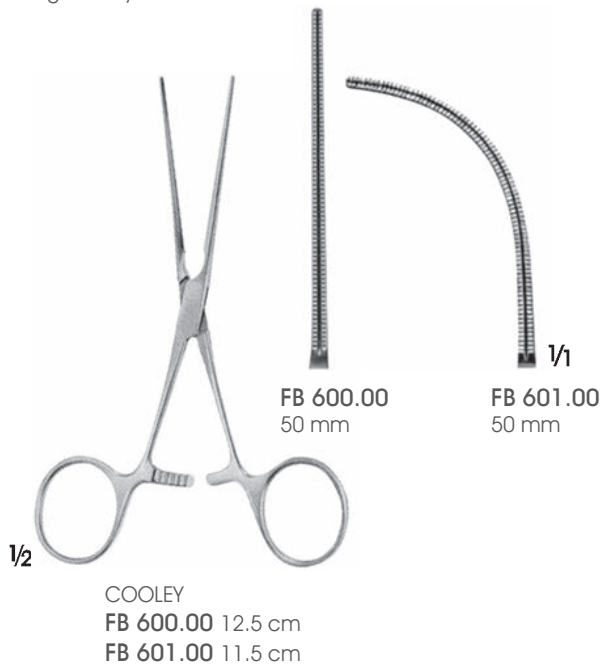

Cooley Diş



Toothing Cooley



COOLEY
FB 608.00 12 cm
FB 609.00 11.5 cm

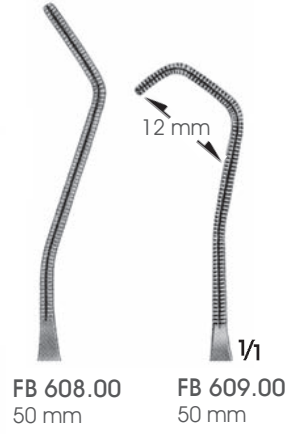

COOLEY
FB 611.00
14.5 cm



COOLEY
FB 612.00
14 cm

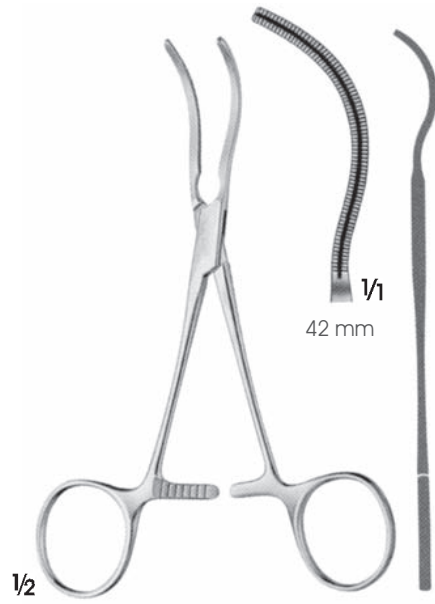

COOLEY
FB 613.00
14.5 cm



SATINSKY
MB 615.00
14 cm

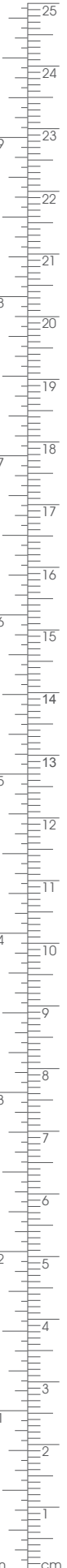

Cooley Diş



Toothing Cooley

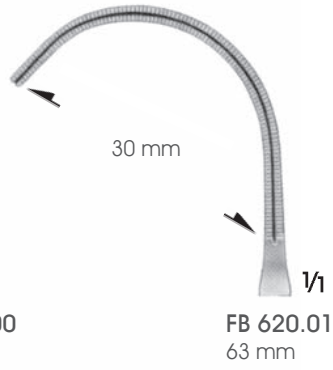
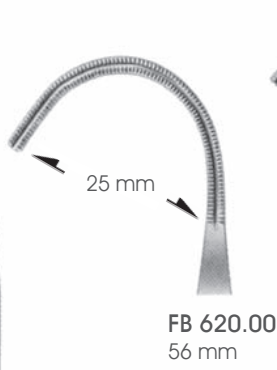

COOLEY-BECK
FB 620.00 15 cm
FB 620.01 15.5 cm

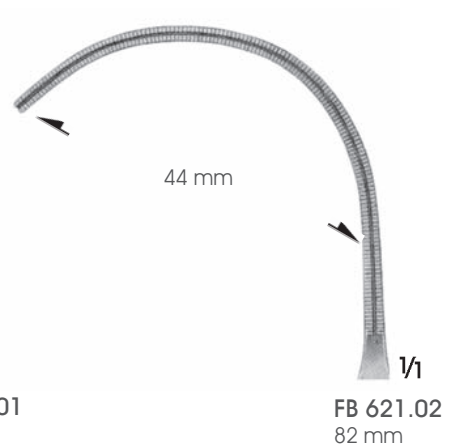
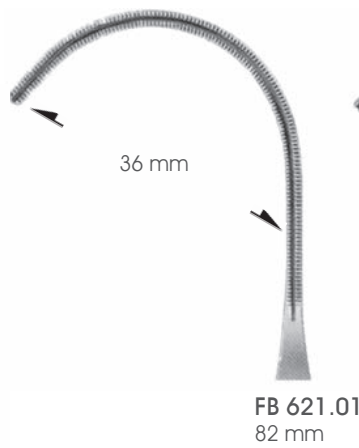

COOLEY
FB 621.01-FB 621.02
17 cm

Cooley Diş



Toothing Cooley



FB 630.00
71 mm

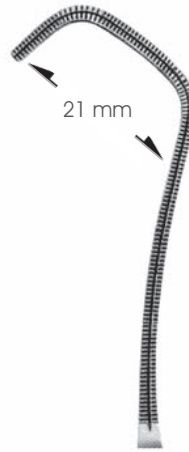

FB 630.01
76 mm

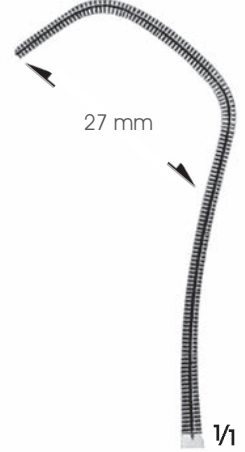

FB 630.02
80 mm

DERRA-COOLEY

FB 630.00 17 cm

FB 630.01 17.5 cm

FB 630.02 17.5 cm

Anastomoz klempler/Anastomosis clamps

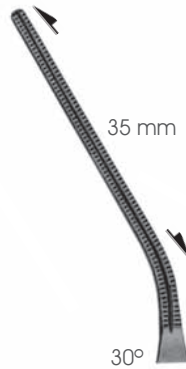

FB 642.00
48 mm

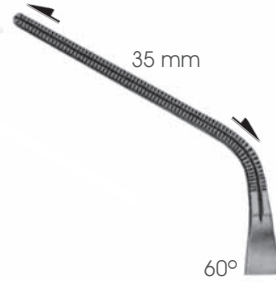

FB 641.00
52 mm

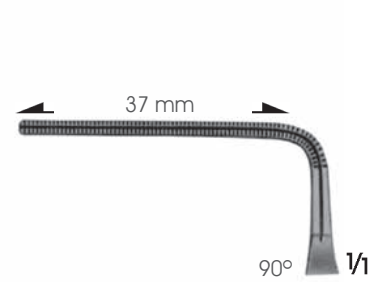

FB 640.00
56 mm

COOLEY

FB 640.00 15 cm

FB 641.00 16 cm

FB 642.00 16.5 cm

Çok amaçlı klempler/Multi Purpose clamps



Cooley Diş



Toothing Cooley

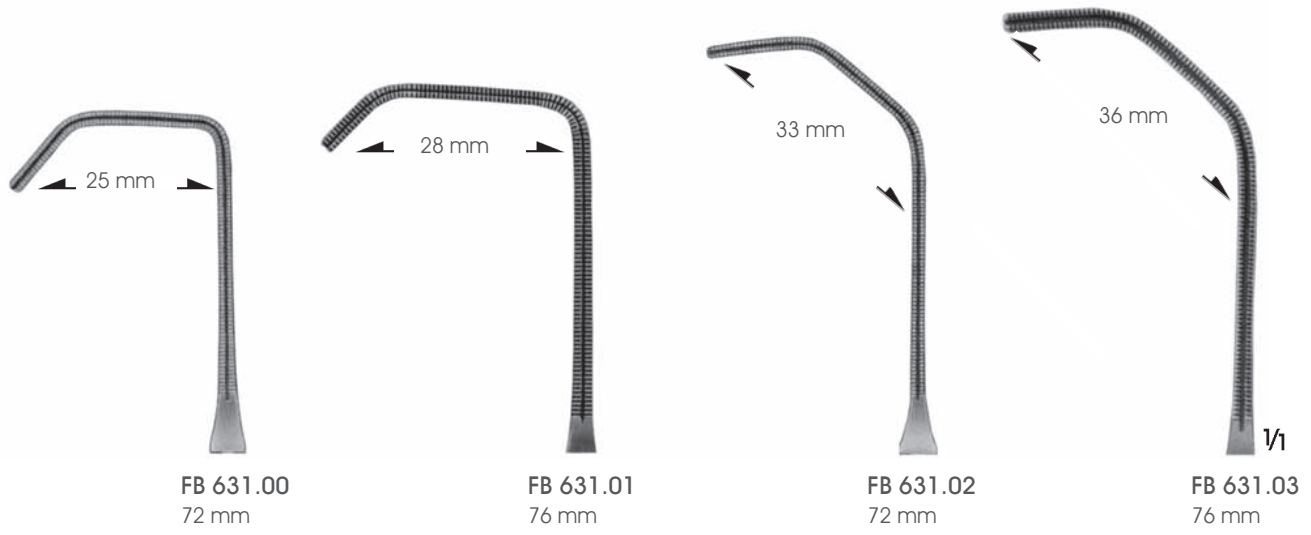

COOLEY
FB 631.00 16.5 cm
FB 631.01 16.5 cm
FB 631.02 17.5 cm
FB 631.03 18 cm

Cooley Diş



Tothing Cooley

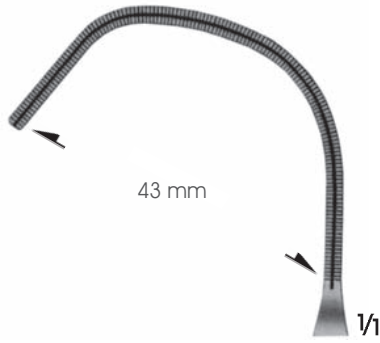

43 mm

1/1



1/2

LEITZ
FB 643.00
20.5 cm

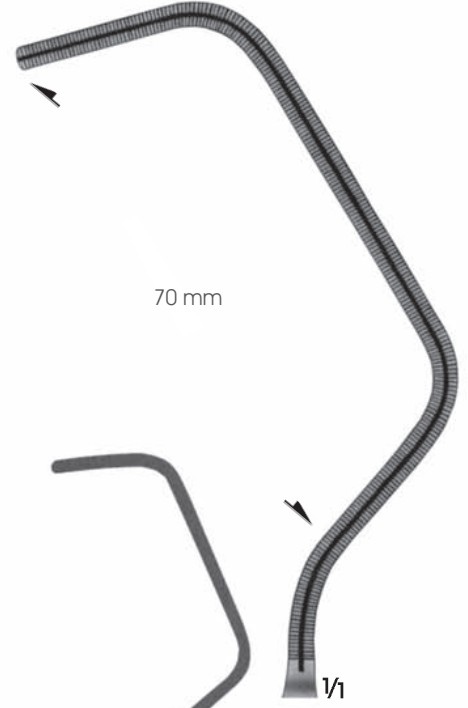

70 mm

1/1



1/2

PARRY-COOLEY
FB 644.00
29.5 cm



Cooley Diş



Toothing Cooley

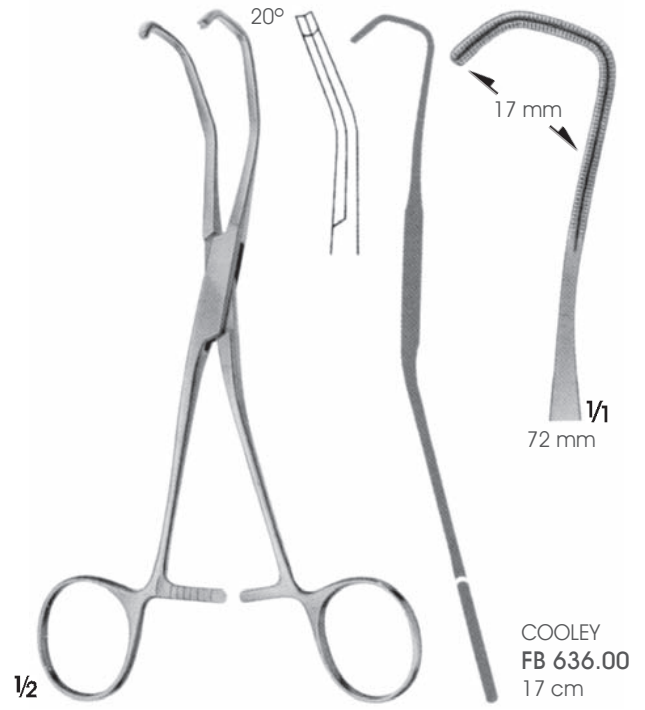
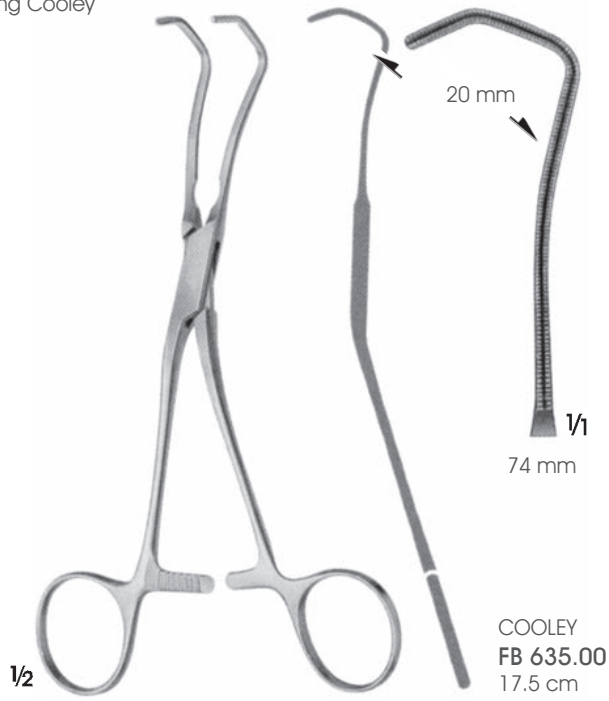

Cooley Diş



Toothing Cooley

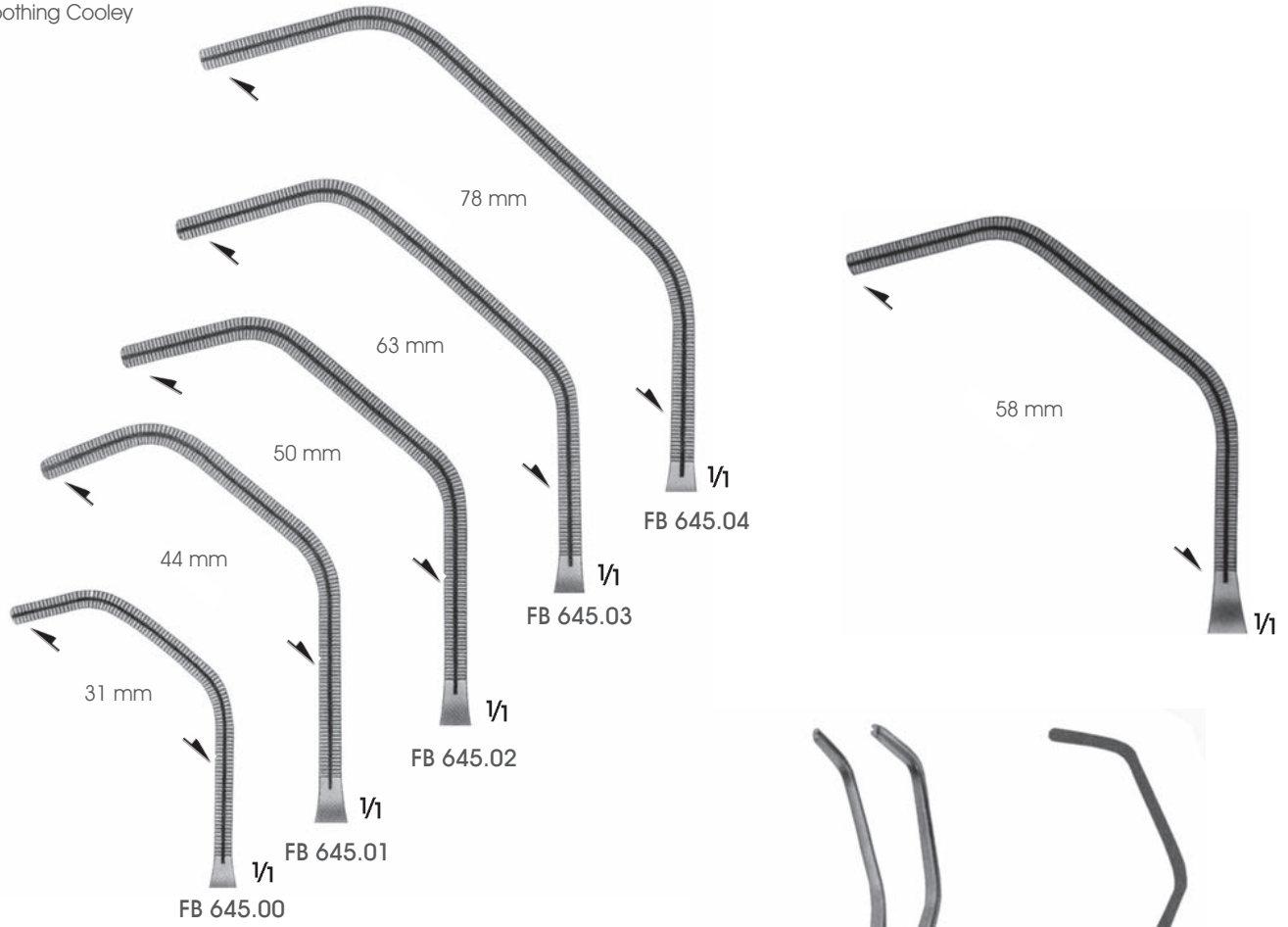

COOLEY
 FB 645.00 20.5 cm
 FB 645.01 26 cm
 FB 645.02 26.5 cm
 FB 645.03 26.5 cm
 FB 645.04 27.5 cm



COOLEY
 FB 647.00
 26 cm

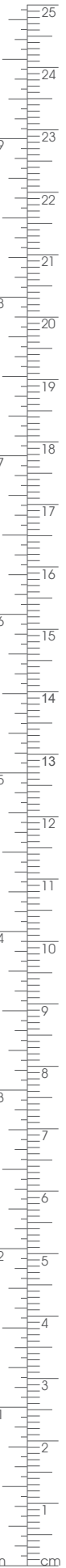

Cooley Diş



Toothing Cooley

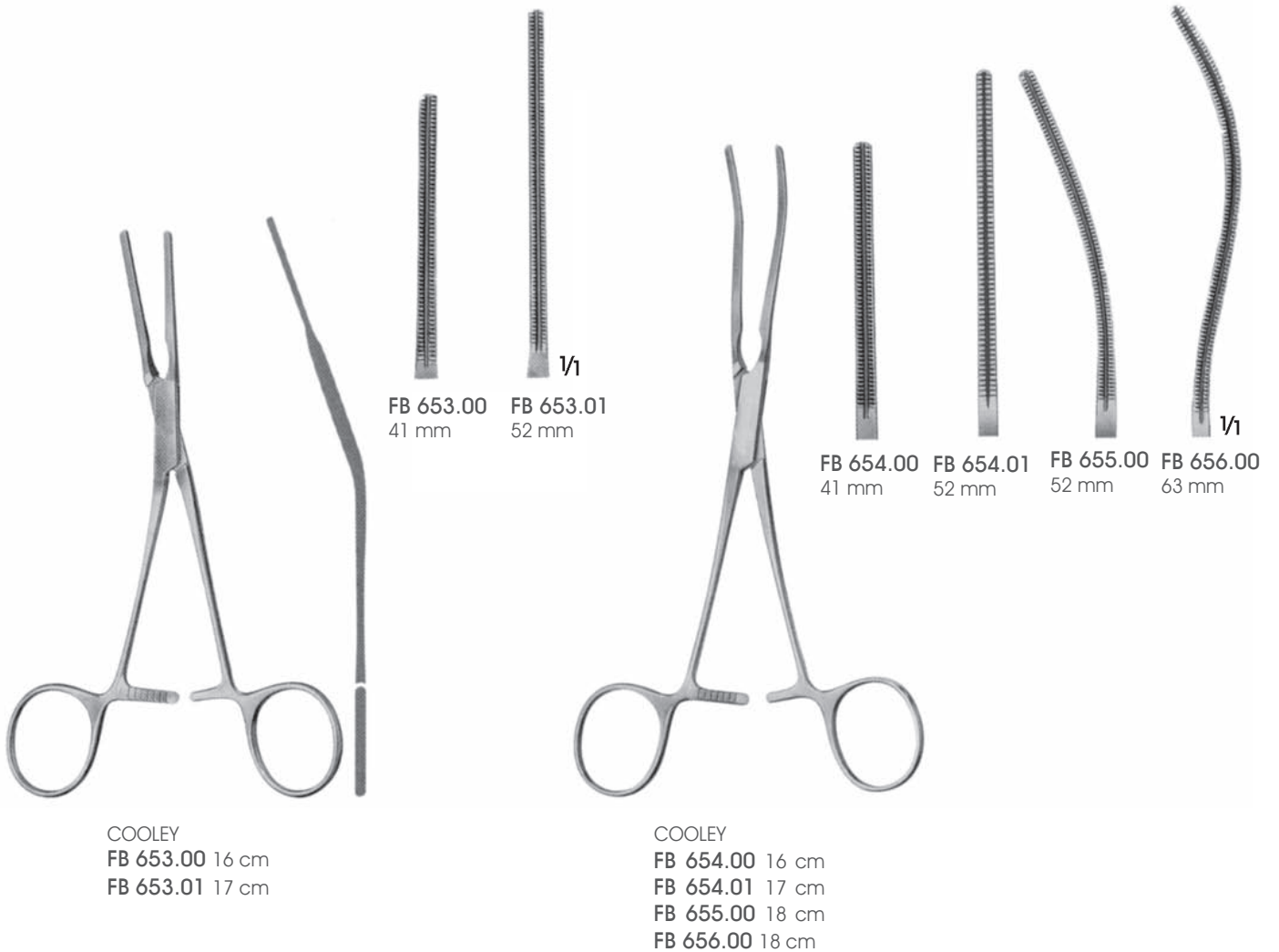

Cooley Diş



Toothing Cooley

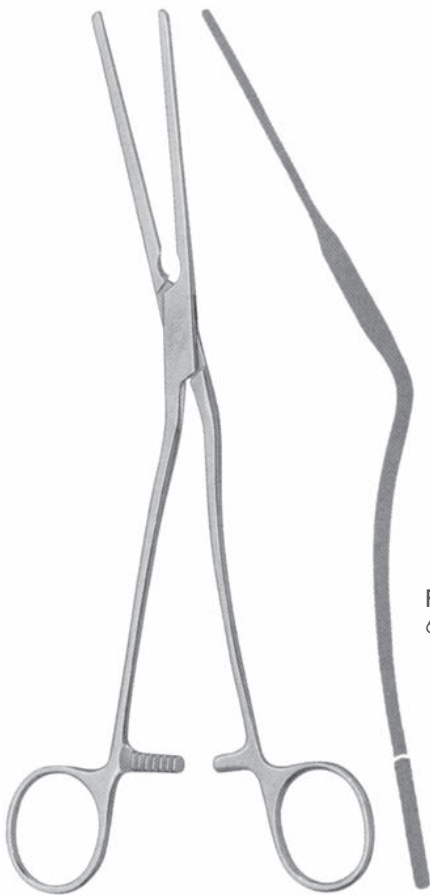
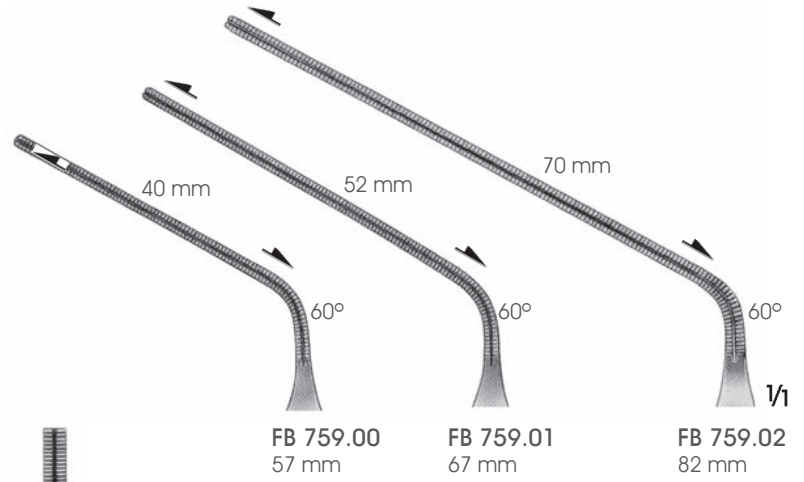

FB 758.00 22.5 cm
FB 758.01 27 cm

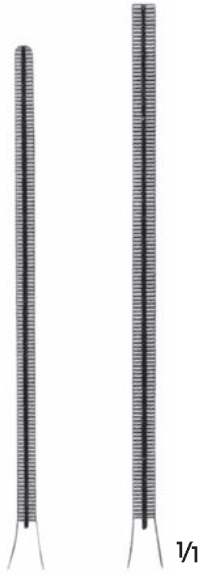

FB 758.00 68 mm
FB 758.01 75 mm
1/1



FB 759.00 16.5 cm
FB 759.01 17 cm
FB 759.02 18.5 cm

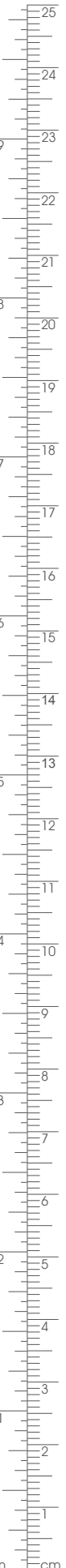

Cooley Diş



Toothing Cooley

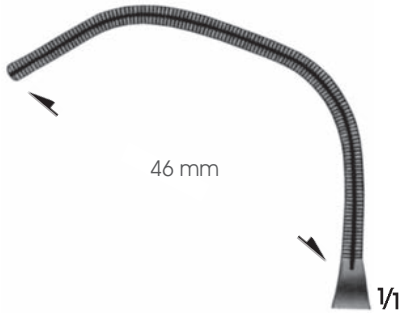

1/2

COOLEY
FB 755.00
22 cm



1/2

COOLEY
FB 756.00
28.5 cm

Cooley Diş



Toothing Cooley



$\frac{1}{2}$

$\frac{1}{1}$
115 mm

COOLEY
FB 757.00
32 cm

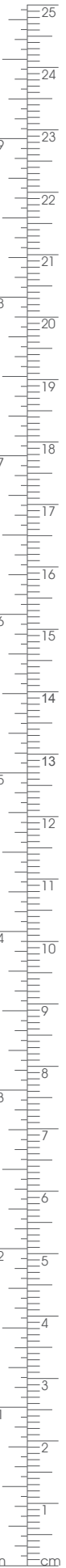

BN Sondalar, Aspiratör Uçları, Trokarlar ve Biyopsi İğneleri
Probes, Suction Tubes, Trocars and Biopsy Needles



 **ARGENT**

Ø 3.5 mm

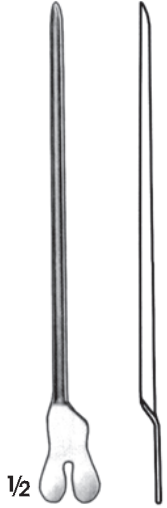

BN 010.00 13 cm
BN 010.01 14.5 cm
BN 010.02 16 cm
İçerik kanallı sondalar
Directors



DOYEN
BN 012.00
İçerik kanallı sonda
Director
14.5 cm



NELATON
BN 013.00
İçerik kanallı sonda
Director
16 cm



BN 015.00
İçerik klavuzlu sonda
Director with tip
14 cm

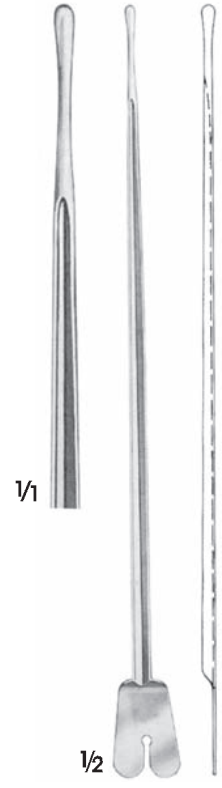

BRODIE
BN 018.00
İçerik klavuzlu sonda
Director with tip
20 cm

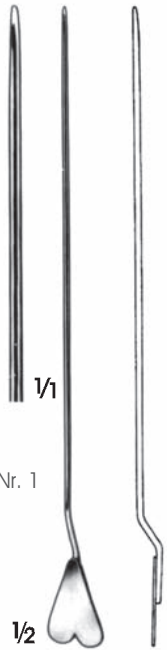

Nr. 1

LOCKHART-MUMMERY
BN 020.00 Nr. 1 Düz/Straight
BN 020.01 Nr. 2 45° Eğri/Curved
BN 020.02 Nr. 3 90° Eğri/Curved
BN 020.03 Nr. 4 Eğri/Curved Fistül
sondalar/Fistula probes 16.5 cm

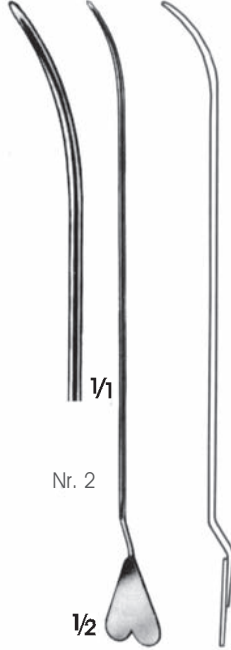

Nr. 2

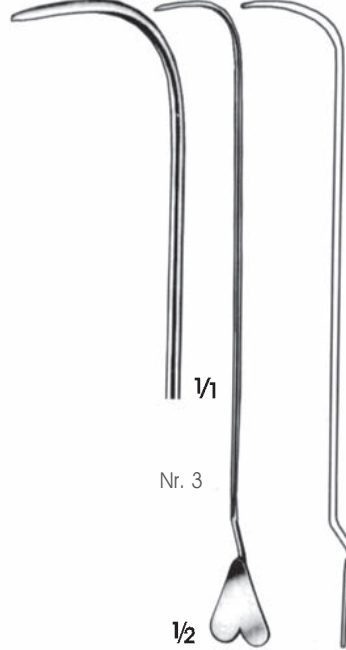

Nr. 3

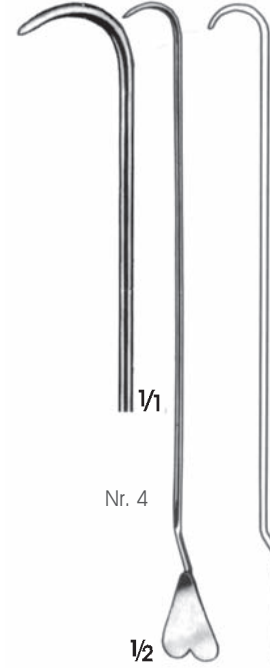

Nr. 4



BN 024.00
İçerik kanallı tel klavuzlu
sonda, bükülebilir
Director with wire
loop, malleable
19 cm

Ø 2.0 mm



BN 030.00 13 cm
BN 030.01 14.5 cm
BN 030.02 16 cm
BN 030.03 18 cm
BN 030.04 20 cm
Mirtle yaprak sondalar
Myrtle leaf probes

Ø 1.5 mm



1/2
BN 031.00
Mirtle yaprak sonda
Myrtle leaf probe
14.5 cm



BN 035.00 Ø 2.5 mm 14.5 cm
BN 035.01 Ø 2.5 mm 16 cm
BN 035.02 Ø 3.0 mm 20 cm
Delikli sondalar
Probes with eye



BN033.01-J
033.20 Sondalar/
Probes

Uc çapı Diameter of tip	1 mm	1.5 mm	2 mm	Uzunluk Length
-	-	BN 033.07	-	13 cm
BN 033.01	BN 033.08	BN 033.15	BN 033.16	14.5 cm
-	BN 033.09	BN 033.17	BN 033.18	16 cm
-	BN 033.10	BN 033.17	BN 033.18	18 cm
-	BN 033.11	BN 033.18	-	20 cm
-	BN 033.12	-	-	25 cm
-	-	BN 033.20	-	30 cm

Ø 3.5 mm



BN 038.00 25 cm
BN 038.01 30 cm
Çift başlı sondalar
bükülebilir, delikli
Double ended probes,
malleable, with hole

Ø 4 mm



BN 039.00
Çift başlı sonda
bükülebilir
Double ended probe,
malleable
40 cm

Ø 2.0 mm



BN 040.01
Sonda/Probe
30 cm

Ø 1.2 mm



BN 039.10
Sinus sonda
Sinus probe
15 cm

Ø 3 mm



BN 037.00
Çift başlı sonda
bükülebilir, delikli
Double ended probe,
malleable, with hole
19 cm

1/2



BN 034.00
12.5 cm

1/2



BN 039.10
Sinus sonda
Sinus probe
15 cm

1/2



BN 037.00
Çift başlı sonda
bükülebilir, delikli
Double ended probe,
malleable, with hole
19 cm

1/4



BN 039.00
Çift başlı sonda
bükülebilir
Double ended probe,
malleable
40 cm

1/3



BN 040.01
Sonda/Probe
30 cm



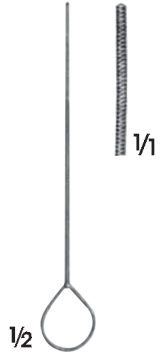

KINGS'S COLLEGE HOSPITAL
BN 044.03
Pamuk aplikatör
Cotton applicator
Sert burgulu
Rough, spiral end
9 cm

Ø 0.8 mm



STACKE
BN 042.00
Sonda/Probe
Gümüş/Silver
10 cm



KINGS'S COLLEGE HOSPITAL
BN 044.05
Pamuk aplikatör
Cotton applicator
Sert burgulu
Rough, spiral end
13.5 cm



CAWTHORNE
BN 044.10
Sonda/Probe
Yaprak uçlu, gümüş
Flattened end silver
14 cm



BOWMAN
OB 049.00 Ø 0.7 + 0.8 mm
OB 049.01 Ø 0.9 + 1.1 mm
OB 049.02 Ø 1.3 + 1.4 mm
OB 049.03 Ø 1.5 + 1.6 mm
OB 049.04 Ø 1.8 + 1.9 mm
Sondalar/Probes
Gümüş/Silver
13 cm

Ø 0.9 mm



BUCK
BN 050.00
Pamuk aplikatör
Cotton applicator
Ucu sert burgulu
Rough, spiral end
12 cm

Ø 1.4 mm



BN 043.00
Sonda/Probe
16 cm

Ø 0.1 mm



SEIFFERT
OM 045.00
Sonda/Probe
Gümüş/Silver
19.5 cm

Ø 1.5 mm



KILLIAN
BN 047.00
Sonda/Probe
16.5 cm

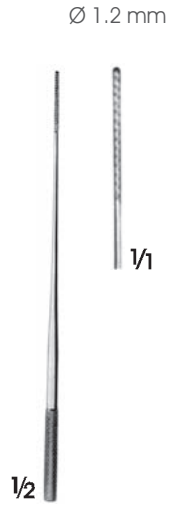

FARRELL
BN 055.01
Ucu yuvarlak tırtıllı
Round serrated end
14 cm



LATHBURY-FARRELL
BN 056.01
Ucu üçgen tırtıllı
Triangular serrated end
14 cm

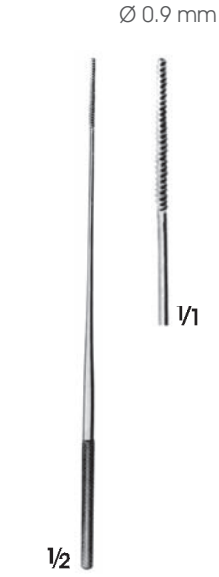

LATHBURY-FARRELL
BN 051.00
Ucu üçgen tırtıllı
Triangular serrated end
14 cm



BN 052.01
Ucu sert burgulu
Rough, spiral end
14 cm

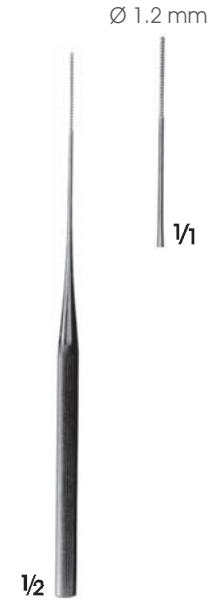

BN 052.02
Ucu sert burgulu
Rough, spiral end
14 cm



BN 052.05
Ucu sert burgulu
Rough, spiral end
18 cm

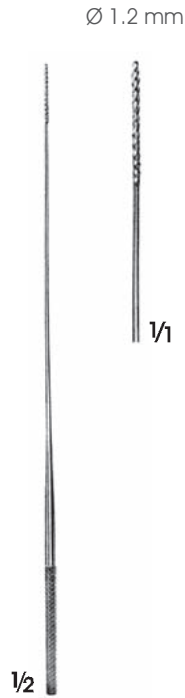

FARRELL
BN 055.02
Ucu sert burgulu
Rough, spiral end
16 cm



LATHBURY-FARRELL
BN 059.00
Ucu üçgen tırtıl
Triangular serrated end
16 cm



LATHBURY-FARRELL
BN 056.02
Ucu üçgen tırtıl
Triangular serrated end
16 cm



BN 052.06
Ucu sert burgulu
Rough, spiral end
18 cm



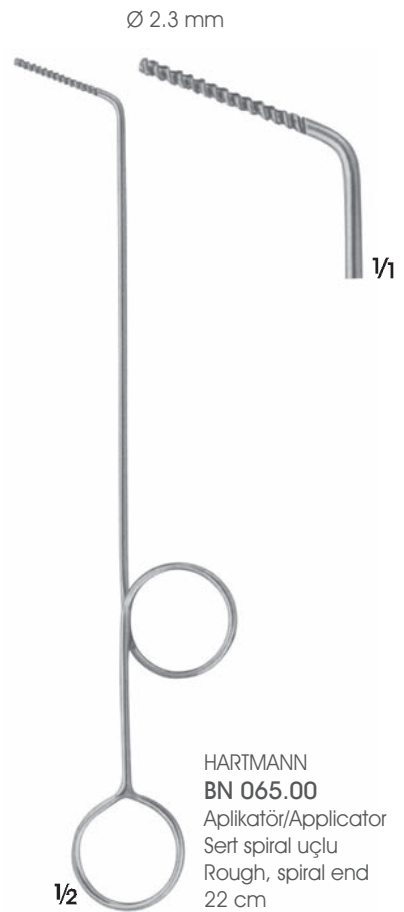



Çalışma boyu
Working length

Tam boy
Total Length

FERGUSSON

Çalışma boyu Working length	11 cm	13 cm	16 cm	20 cm	Ø
Tam boy Total Length	18 cm	21.5 cm	24.5 cm	28 cm	Ø
	GF 215.01	GF 215.21	GF 215.51	GF 215.81	1.5 mm
	GF 215.02	GF 215.22	GF 215.52	GF 215.82	2.0 mm
	GF 215.03	GF 215.23	GF 215.53	GF 215.83	2.5 mm
	GF 215.04	GF 215.24	GF 215.54	GF 215.84	3.0 mm
	GF 215.06	GF 215.26	GF 215.56	GF 215.86	4.0 mm
	GF 215.08	GF 215.28	GF 215.58	GF 215.88	5.0 mm

Parmak kumandalı, temizleme telli
parmak basma yüzeyi yatay LUER bağlantı
With finger cut-of and styled
Thumb piece 90° to curve, With LUER hub



Olive
Ø 6-9 mm



FERGUSSON
GF 220.02 Ø 4 mm
İzoleli, parmak kumandalı,
temizleme telli
parmak basma yüzeyi yatay
LUER bağlantı
Isolated, with finger cut-of and stylet,
thumb piece 90° to curve, with LUER
hub
18 cm

1/2

Olive
Ø 6-9 mm



FRAZIER
GF222.00 Ø 3 mm
GF 222.01 Ø 5 mm
Parmak kumandalı, temizleme
telli parmak basma yüzeyi
yatay LUER bağlantı
With finger cut-of and stylet
Thumb piece 90° to curve,
with LUER hub
18 cm

1/2



FRAZIER
GF 221.00 Ø 2.3 mm
GF 221.01 Ø 2.7 mm
GF 221.02 Ø 3.4 mm
GF 221.03 Ø 4.0 mm
Parmak kumandalı, temizleme
telli parmak basma yüzeyi yatay
LUER bağlantı
With finger cut-of and stylet
Thumb piece 90° to curve,
with LUER hub
11 cm

1/2



ZOELLNER

BN 032.01 Ø 26 swg, Ø 0.4 mm

BN 032.02 Ø 24 swg, Ø 0.5 mm

BN 032.04 Ø 22 swg, Ø 0.7 mm

BN 032.06 Ø 20 swg, Ø 1.0 mm

BN 032.08 Ø 18 swg, Ø 1.2 mm

BN 377.01 ve BN 378.00 için sökülüp takılabilir uçlar Detachable ends fitting to J 377.01 and J 378.00 10'luk paket/Package of 10 pieces

1/1



VERHOEVEN

SF 729.01 Ø 24 swg, Ø 0.5 mm

SF 729.02 Ø 22 swg, Ø 0.7 mm

SF 729.04 Ø 20 swg, Ø 1.0 mm

SF 729.06 Ø 18 swg, Ø 1.2 mm

SF 729.08 Ø 16 swg, Ø 1.5 mm

Aspiratör ucu, LUER koniği Suction cannulae with Luer cone 10 cm

1/2

Olive
Ø 7 mm



HOUSE

GF 461.01

Parmak kumandalı emiş adaptörü LUER koniği, LUER bağlantılı Suction adapter with finger cut-off, LUER cone, LUER hub 5.5 cm

1/1



PLESTER

GF 212.00 Ø 1.5 mm

GF 212.01 Ø 2.0 mm

GF 212.02 Ø 2.5 mm

GF 212.03 Ø 3.0 mm

Parmak kumandalı, temizleme telli parmak basma yüzeyi baş parmağa paralel LUER bağlantı With finger cut-off and stylet, thumb piece parallel to curve, with LUER hub 19.5 cm

Olive
Ø 6-9 mm

1/2

Ø 4 mm



Olive
Ø 9 mm

ADSON

GF 219.00

Parmak kumandalı With finger cut-off 19 cm

1/2

Ø 3 mm



ADSON

SK 232.00

Aspiratör ucu Suction cannula Parmak kumandalı ve temizleme telli With finger cut-off and stylet 16.5 cm

Olive
Ø 8 mm

1/2



GILLIES
GF 227.01 Ø 3 mm
Parmak kumandalı ve temizleme telli
With finger cut-off and stylet
17 cm



LEMPERT
GF 224.01 Ø 2 mm
GF 224.02 Ø 3 mm
Parmak kumandalı ve temizleme telli
With finger cut-off and stylet
20 cm



FORMBY
GF 225.01 Ø 3.3 mm 21 cm

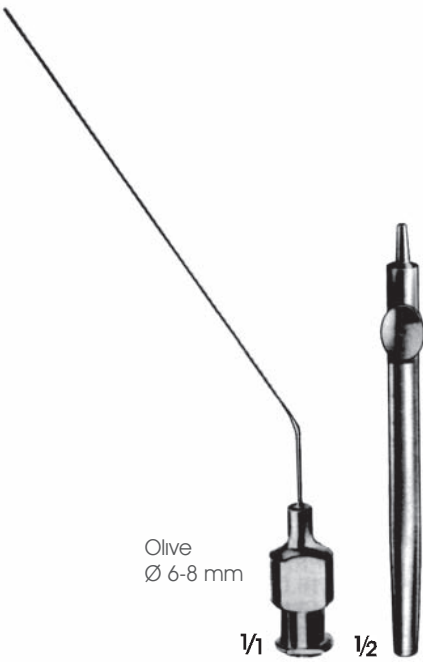

Olive
Ø 6-8 mm

1/1

1/2

OG 236.10 Komple/Complete
OG 236.00 Sap/Handle
OG 236.01 Ø 0.5 mm
OG 236.02 Ø 0.7 mm
OG 236.03 Ø 1.0 mm
OG 236.04 Ø 1.3 mm
LUER koniği/With LUER cone



Olive
Ø 6-8 mm

1/2

WULLSTEIN
OG 238.10 Komple/Complete
OG 238.00 LUER bağlantılı sap
handle with LUER hub
OG 238.01 Ø 0.4 mm
OG 238.02 Ø 0.6 mm
OG 238.03 Ø 0.8 mm



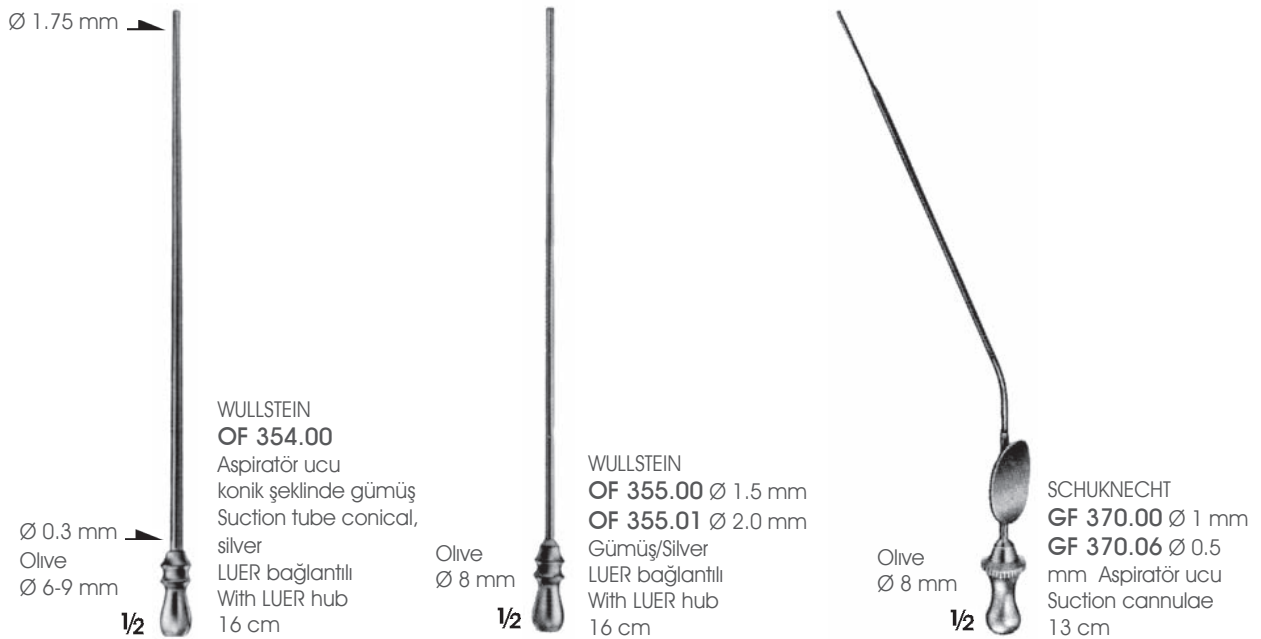
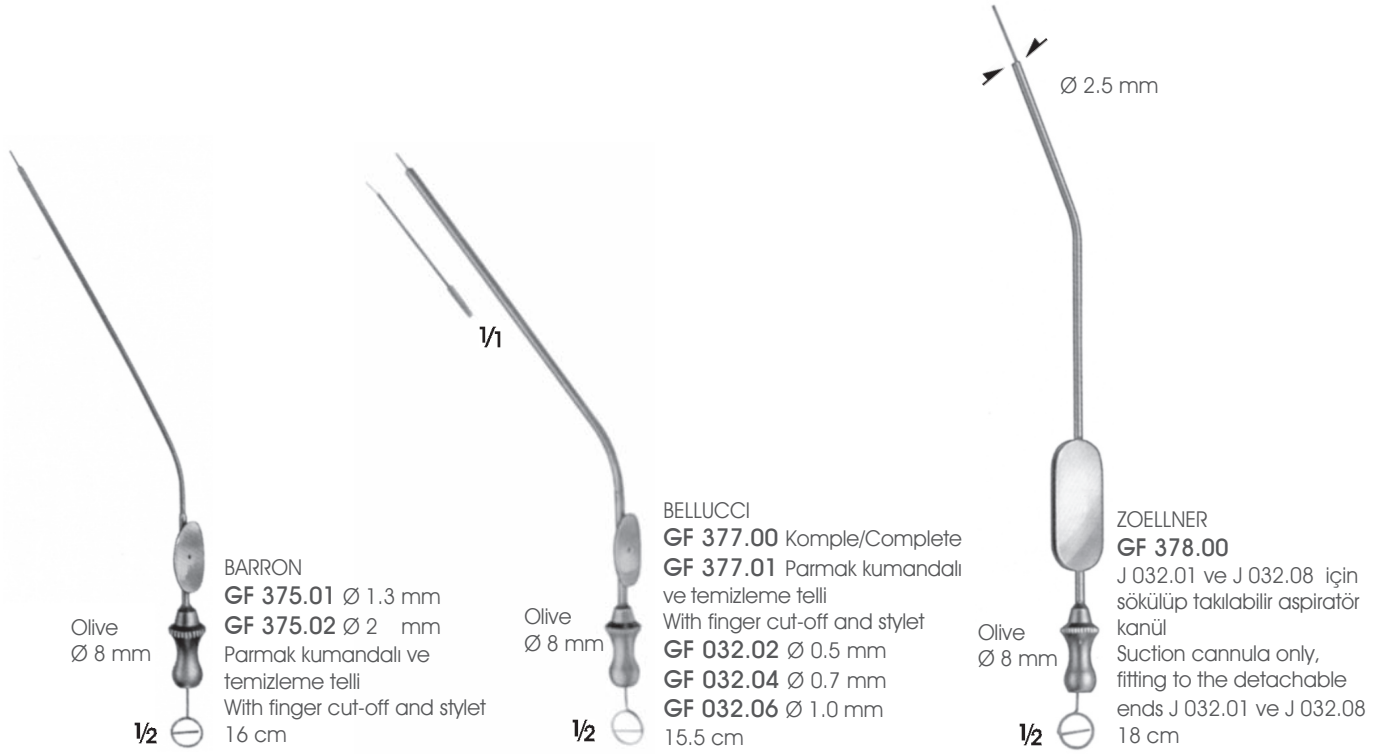

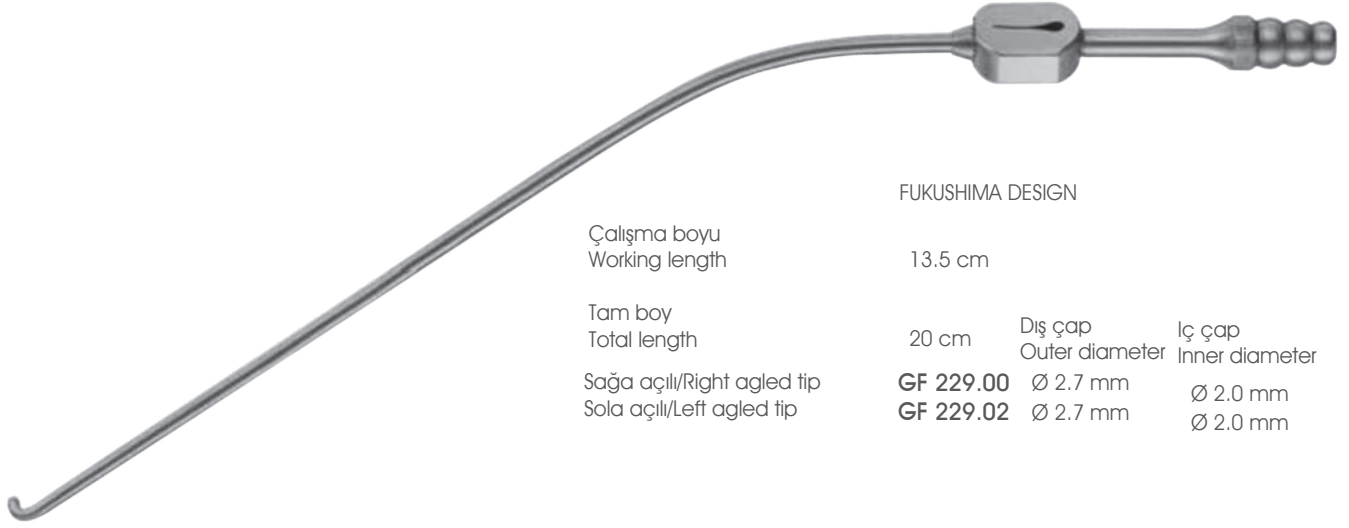

FUKUSHIMA DESIGN

Çalışma boyu
Working length

13.5 cm

Tam boy
Total length

20 cm

Sağa açılı/Right angled tip
Sola açılı/Left angled tip

GF 229.00

GF 229.02

Diş çap

Outer diameter

Ø 2.7 mm

İç çap

Inner diameter

Ø 2.0 mm

Ø 2.0 mm

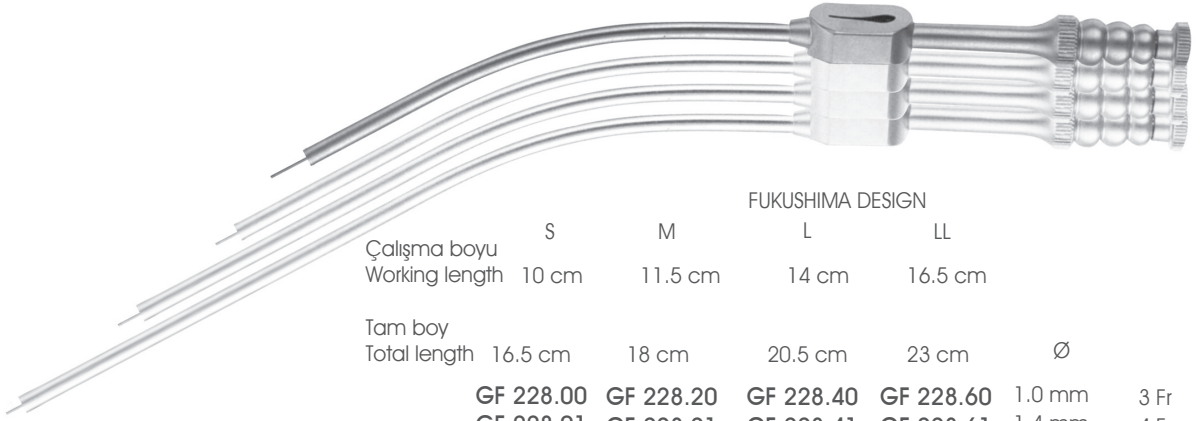

FUKUSHIMA DESIGN

Çalışma boyu
Working length

S

M

L

LL

10 cm

11.5 cm

14 cm

16.5 cm

Tam boy
Total length

16.5 cm

18 cm

20.5 cm

23 cm

Ø

GF 228.00

GF 228.20

GF 228.40

GF 228.60

1.0 mm

3 Fr

GF 228.01

GF 228.21

GF 228.41

GF 228.61

1.4 mm

4 Fr

GF 228.02

GF 228.22

GF 228.42

GF 228.62

1.7 mm

5 Fr

GF 228.03

GF 228.23

GF 228.43

GF 228.63

2.0 mm

6 Fr

GF 228.04

GF 228.24

GF 228.44

GF 228.64

2.3 mm

7 Fr

GF 228.05

GF 228.25

GF 228.45

GF 228.65

2.7 mm

8 Fr

GF 228.06

GF 228.26

GF 228.46

GF 228.66

3.0 mm

9 Fr

GF 228.09

GF 228.29

GF 228.49

GF 228.69

4.0 mm

12 Fr

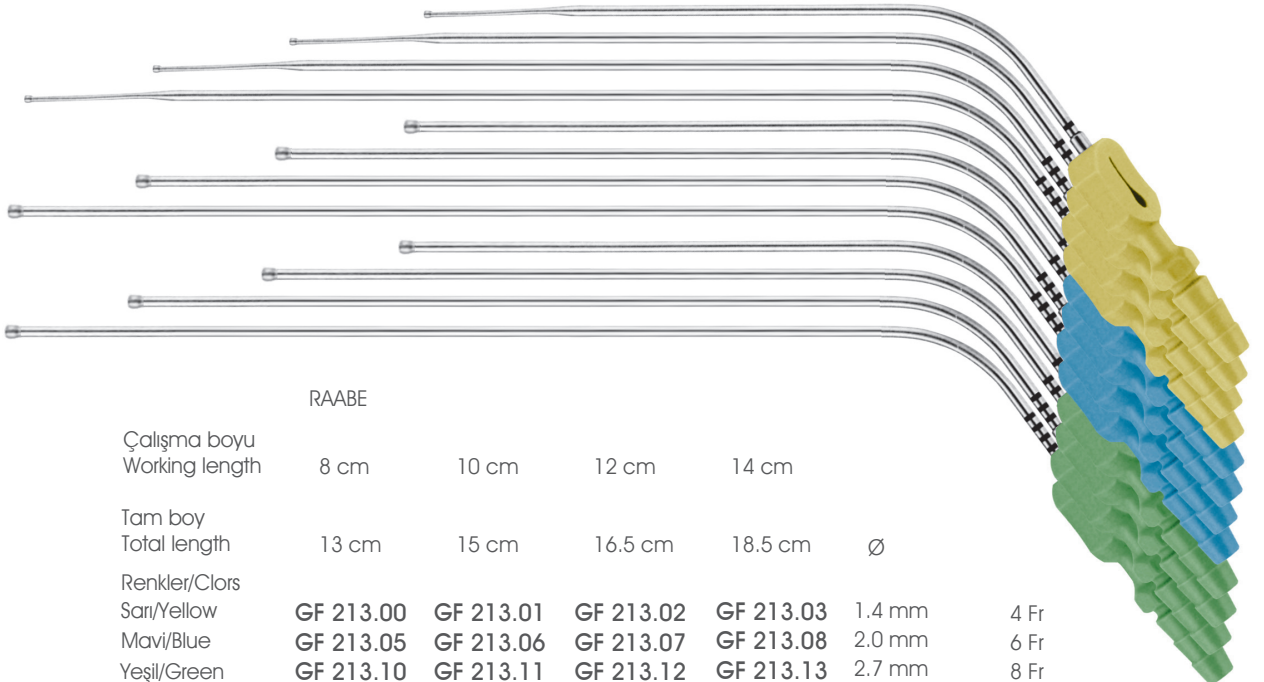

RAABE

Çalışma boyu
Working length

8 cm

10 cm

12 cm

14 cm

Tam boy
Total length

13 cm

15 cm

16.5 cm

18.5 cm

Ø

Renkler/Clors

Sarı/Yellow

GF 213.00

GF 213.01

GF 213.02

GF 213.03

1.4 mm

4 Fr

Mavi/Blue

GF 213.05

GF 213.06

GF 213.07

GF 213.08

2.0 mm

6 Fr

Yeşil/Green

GF 213.10

GF 213.11

GF 213.12

GF 213.13

2.7 mm

8 Fr

GF 604.00

Parmak kumandalı ve temizleme telli
With finger cut-off and stylet

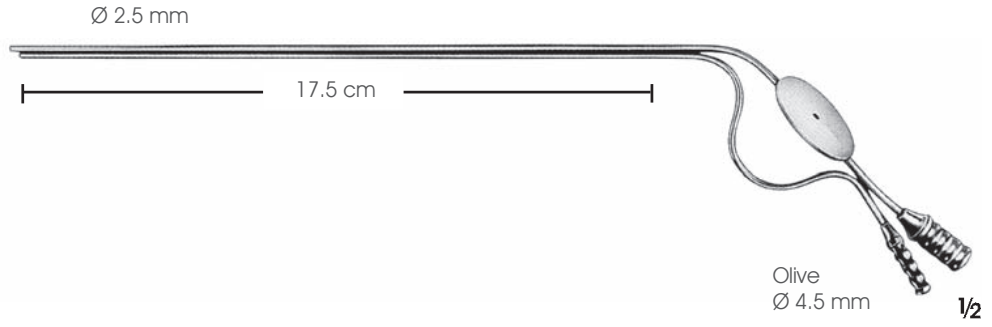

OP 265.00 Ø 2.0 mm

OP 265.01 Ø 2.5 mm

OP 265.02 Ø 3.0 mm

Parmak kumandalı ve temizleme telli
parmak basma yüzeyi yatay
With finger cut-off, thumb piece 90° to curve
25 cm

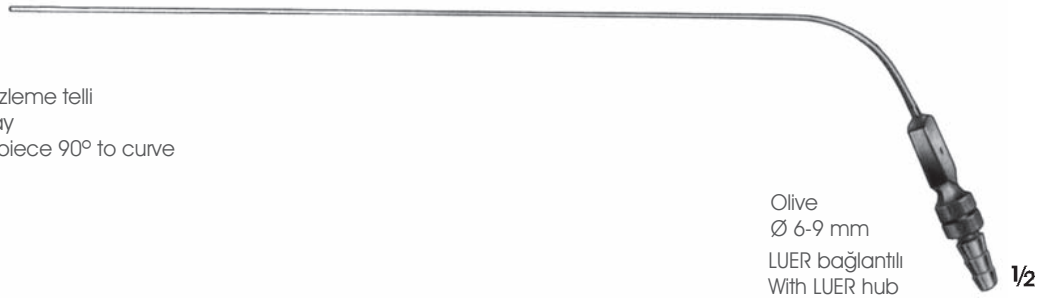

HOUSE

GF 608.00 Ø 0.9 - 0.7 mm

GF 608.01 Ø 1.2 - 0.9 mm

GF 608.02 Ø 1.5 - 1.2 mm

Parmak kumandalı ve temizleme telli
With finger cut-off and stylet

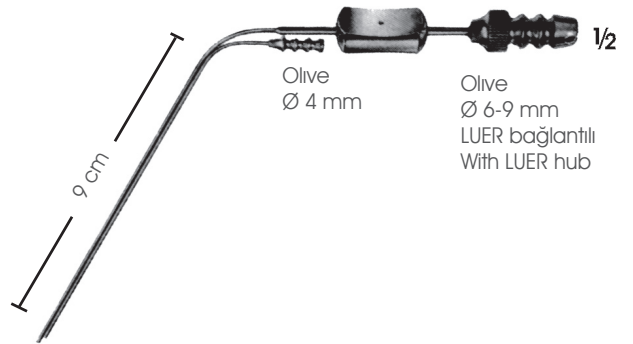

OL 360.00 4 mm

OL 360.01 5 mm

Aspiratör raspa, sivri bayonet tip
Suction raspatories, sharp
bayonet-shaped
20 cm



LANDOLT

OL 361.00 Genişlik/Wide 3.2 mm

Hipofizektomi ve Kbb için aspiratör ucu,
keskin açılı nokta

Dissecting suction tube for
hypophysectomie and ENT, sharp angled
point
20 cm



GF 352.00

Uc genişliği 6.5 mm
Tip wide 6.5 mm
Burun aspiratör ucu, LUER bağlantılı
Nasal suction tube, with LUER hub
18 cm



Olive
Ø 6-9 mm

GORNEY

OL 368.00

Aspiratör disektör
Suction dissector
18 cm



Olive
Ø 6-10 mm

NEGUS

OM 367.00

Aspiratör disektör
Suction dissector
21 cm



Olive
Ø 6 mm

LOPEZ-REINKE

OM 365.00

Aspirasyonlu Tonsil disektör
Tonsil dissector with suction
device
23.5 cm



Olive
Ø 9 mm

YAŞARGİL

GF 602.00

Kanül/Cannulae
LUER-LOC koniği
LUER-LOC cone
20 cm



Ø 2 mm

Ø 4.5 mm

1/1

YASARGIL

Aspiratör uçları/Suction tubes

FD 260.00 Ø 1.5 mm	FD 260.01 Ø 1.5 mm	FD 260.02 Ø 1.5 mm	FD 260.03 Ø 1.5 mm
FD 260.04 Ø 2.0 mm	FD 260.05 Ø 2.0 mm	FD 260.06 Ø 2.0 mm	FD 260.07 Ø 2.0 mm
FD 260.08 Ø 2.5 mm	FD 260.09 Ø 2.5 mm	FD 260.10 Ø 2.5 mm	FD 260.11 Ø 2.5 mm
FD 260.12 Ø 3.5 mm	FD 260.13 Ø 3.5 mm	FD 260.14 Ø 3.5 mm	FD 260.15 Ø 3.5 mm
13 cm	15 cm	FD 260.16 Ø 4.5 mm	
		22 cm 18 cm	

Olive
Ø 6.5-9 mm

LUER bağlantılı
With LUER hub

Ø 3,5 mm

Ø 2,0 mm

OP 263.00 50 cm
OP 263.01 35 cm
Aspiratör uçları/Suction tubes
Lastik uclu
With rubber tip

Olive
Ø 6- 9 mm

LUER bağlantılı
With LUER hub

1/2



ROWBOTHAM
GF 423.00
Kanül/Cannulae
29.5 cm

1/2



MAGILL
GF 422.01 Ø 3.0 mm
GF 422.02 Ø 3.5 mm
GF 422.03 Ø 4.0 mm
Magil emiş kanülü
Stylet for magill suction tubes
24.5 cm

1/2

GF 400.00

Büyük miktarda sıvı temizlemek için
For clearing large quantities of fluid
19 cm

Ø 15 mm

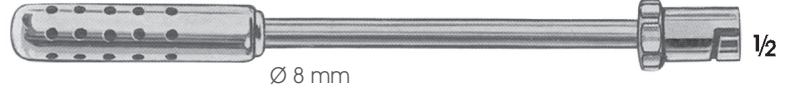

GF 415.00

Delmek için trokar
Trocar, for puncturing
17 cm



GF 418.00

Regülatör ve parmak kumandalı
aspiratör adaptörü
Suction handle, with vacuum regulator
and finger cut-off, brass, mirror-finish
chromium-plated
15 cm

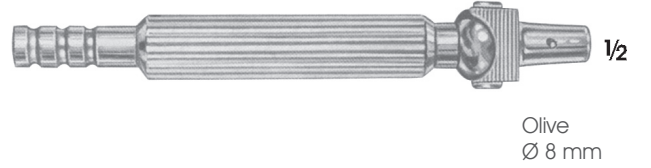

GF 406.00

Çift eğimli genel cerrahi için
Double curved, for general surgery
23 cm



GF 432.00 Ø 9 mm

Üniversal çift eğimli kanül
Universal cannule, double curved
23 cm



POOL

GF 436.00

Aspiratör kanülü, vidalanabilir dış tüpü ile
Suction cannula, with outer tube to be
screwed off
22.5 cm

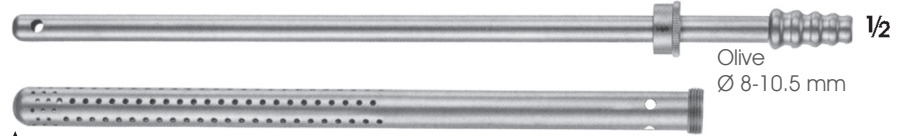

▲
Ø 10 mm
Charr.30

POOL

GF 437.00

Aspiratör kanülü, vidalanabilir dış tüpü ile
Suction cannula, with outer tube to be
screwed off
22.5 cm

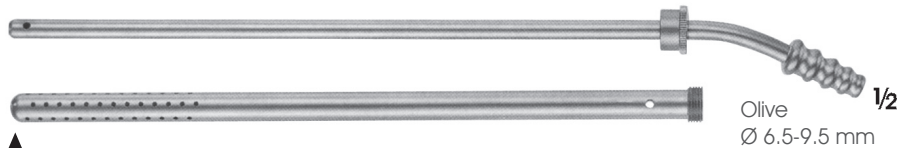

▲
Ø 7 mm
Charr.21

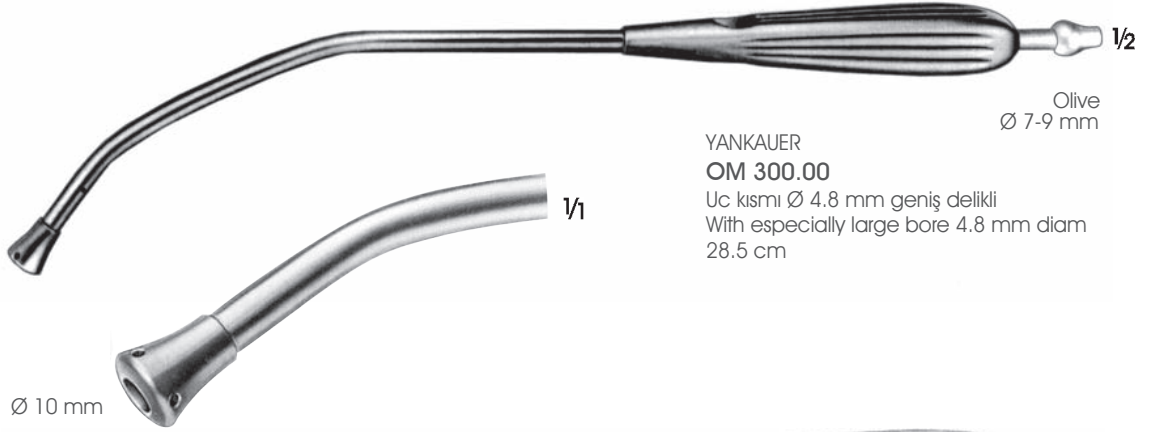



Ø 15 mm

FINSTERER
GF 600.00
Sulama kanülü
Irrigation cannula
32 cm

Olive
Ø 9 -13 mm

1/2

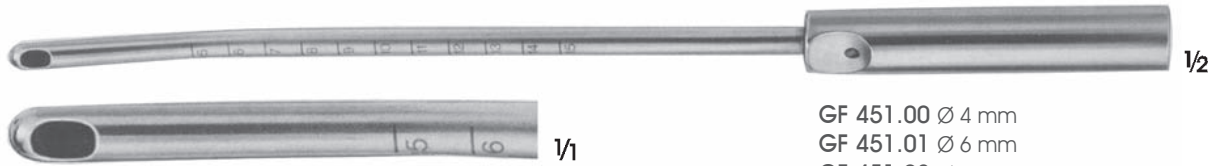

1/1

GF 451.00 Ø 4 mm
GF 451.01 Ø 6 mm
GF 451.02 Ø 8 mm
GF 451.03 Ø 10 mm
GF 451.04 Ø 12 mm
GF 451.05 Ø 14 mm

Vakum küreti, vakumlu kürtaç
için emme kanülü
Curettes with graduation and suction
interrupter, for vacuum curetage

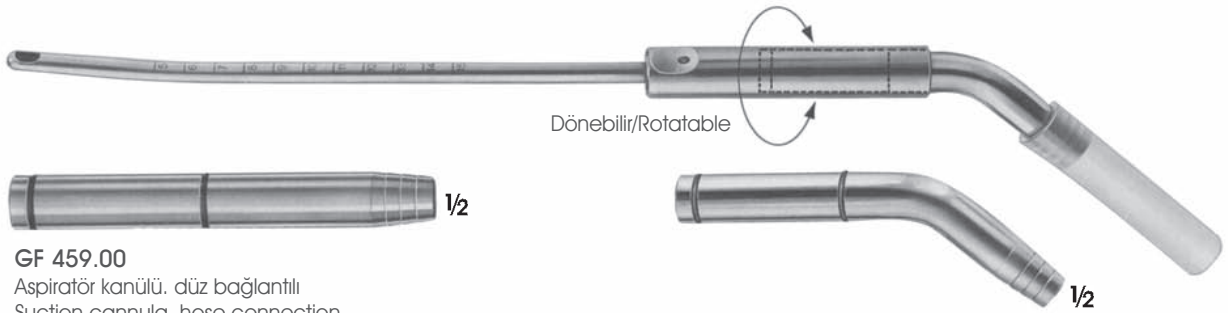

Dönebilir/Rotatable

1/2

1/2

GF 459.00

Aspiratör kanülü, düz bağlantılı
Suction cannula, hose connection
straight
Ø 11 mm

GF 458.00

Aspiratör kanülü, eğri bağlantılı
Suction cannula, hose connection,
curved
Ø 11 mm

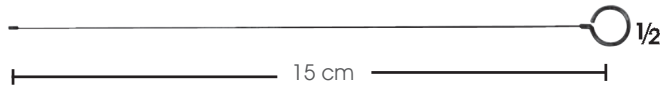

15 cm

1/2

1/1

LANDOLT

GK 620.00 İzoleli/Insulated

Pıhtı emiş kanülü, mandrenli ve stoplu Ø 5 mm
143° buhar sterilizatörlerinde steril edilebilir.
Coagulation suction cannula
with interruptor and mandrel Ø 5 mm
Can be sterilized in a steam sterilizer up to 143°



Çap/Olive
Ø 7.5-12 mm

HF elektrotları tarafından dokunulmuş,
lekelenmemiş bağlantı Ø 4 mm
HF-Elektrot kolu Ø 4 mm
Untarnished contact to be
touched by HF-electrodes Ø 4 mm

1/2

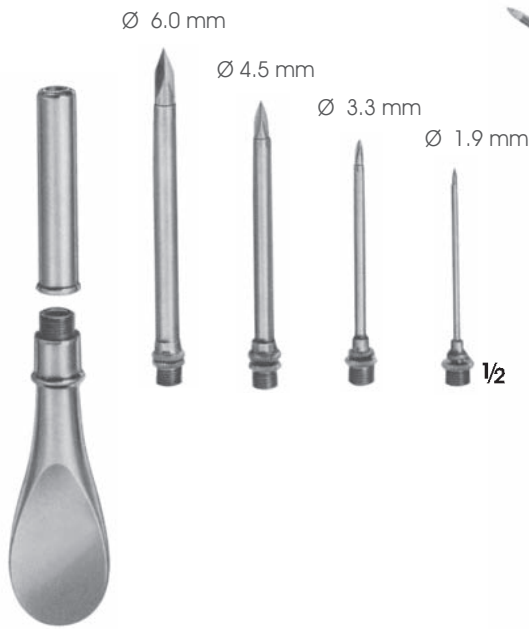

EJ 102.00
4 ucu ile birlikte
sökülebilir trokar
Trocar with interchangeable
tips (4 pcs.)



PIERCE
EJ 108.00 Ø 4.0
mm Antrum trokar
Antrum trocar



KRAUSE
EJ 110.00 Ø 4.0
mm Antrum trokar
Antrum trocar



EJ 130.00 İç/Inside Dış/Outside
EJ 130.01 Ø 2.2 mm Ø 3.3 mm
EJ 130.02 Ø 3.0 mm Ø 4.0 mm
EJ 130.03 Ø 4.0 mm Ø 5.0 mm
Yandan boşaltmalı musluklu, karın
delme trokar
For abdominal puncture, with
stop-cock and lateral drain.

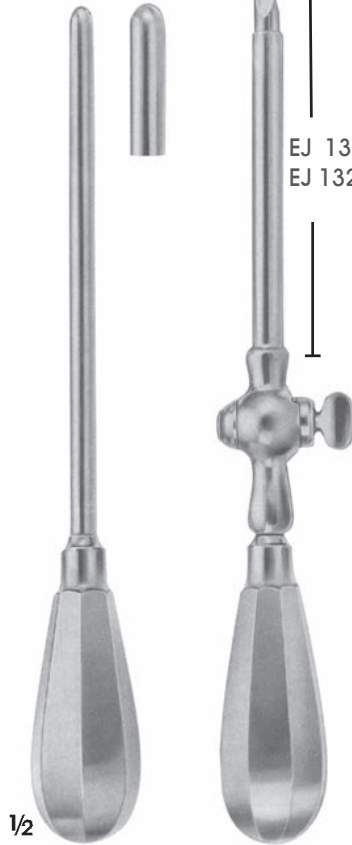

BUELAU
EJ 132.00 İç/Inside Dış/Outside
100 mm
EJ 132.01 Ø 6.5 mm Ø 8.0 mm
Ø 9.0 mm Ø 10.0 mm
mm Ampiyem trokar
Empyema trocar

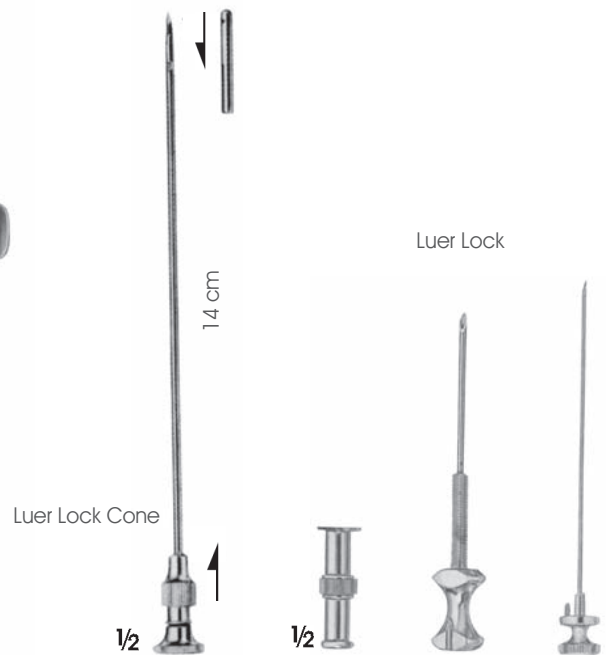

LANDAU
EJ 138.00
Ø 2 mm
Pelvik apse trokar
Pelvic abscess trocar

KLIMA-ROSEGGER
EJ 706.00 35 x 1,8 mm
Göğüs kemiği delici iğne
Sternal puncture needle



1/2

Charr.
FM 800.00 8
FM 800.01 10
FM 800.02 12
FM 800.03 14
FM 800.04 16
FM 800.05 18
Arkası tırtıllı, bıçak tip, hafif eğri
With thread, knife tip, slightly curved
19 cm

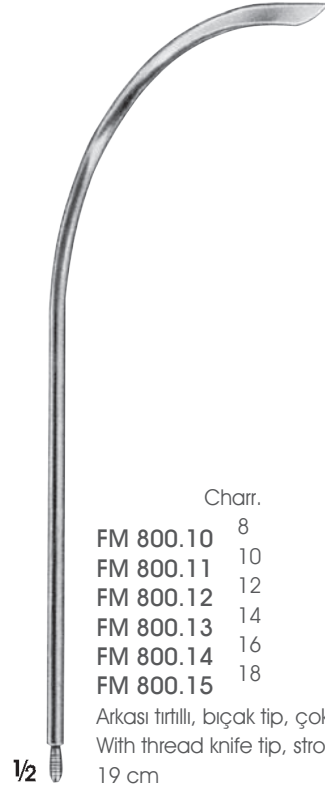

1/2

Charr.
FM 800.10 8
FM 800.11 10
FM 800.12 12
FM 800.13 14
FM 800.14 16
FM 800.15 18
Arkası tırtıllı, bıçak tip, çok eğri
With thread knife tip, strongly curved
19 cm



1/2

Charr.
FM 800.20 8
FM 800.21 10
FM 800.22 12
FM 800.23 14
FM 800.24 16
FM 800.25 18
Arkası tırtıllı, bistüri tip, hafif eğri
With thread, lancet tip, slightly curved
19 cm



1/2

Charr.
FM 800.30 8
FM 800.31 10
FM 800.32 12
FM 800.33 14
FM 800.34 16
FM 800.35 18
Arkası tırtıllı, trokar tip, hafif eğri
With thread, trocar tip, slightly curved
19 cm



BT El Ekartörleri, Huklar ve Spatulalar
Retractors, Hooks and Spatulas



 **ARGENT**

	<p>Ekartörler için ölçü sistemi Derinlik :1 Genişlik :2 Örnek:1 x 2</p>	<p>Measurement system for retractor blades Depth:1 Width :2 Example:1 x 2</p>
---	---	---

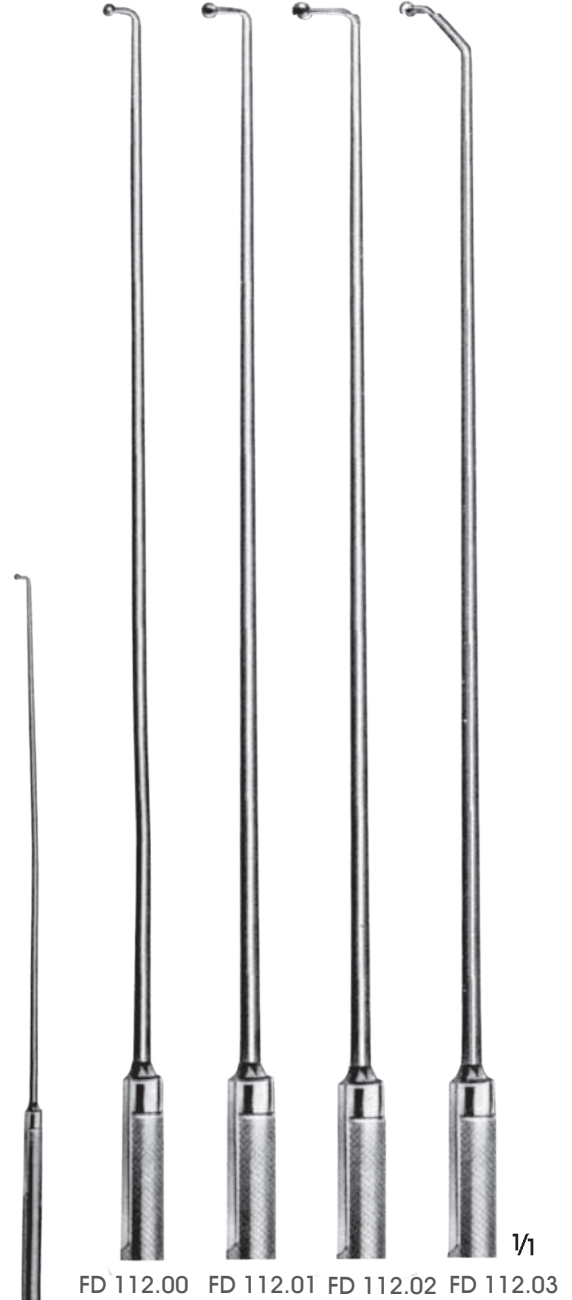
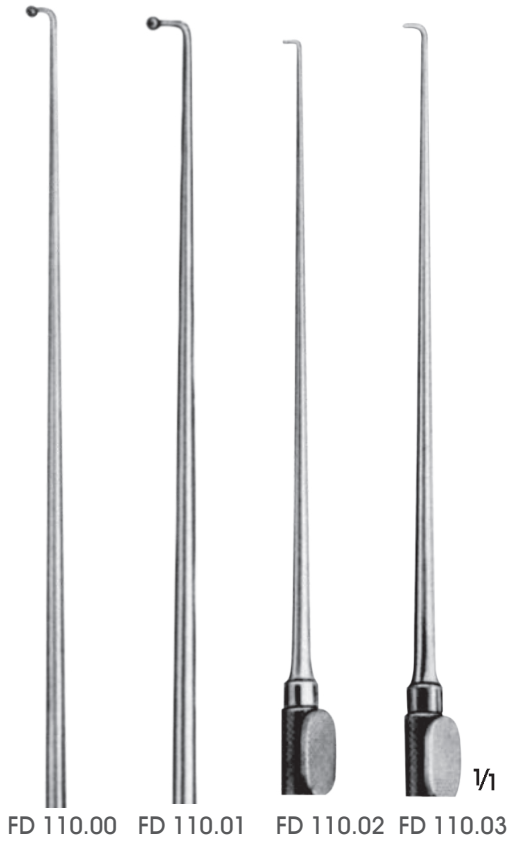

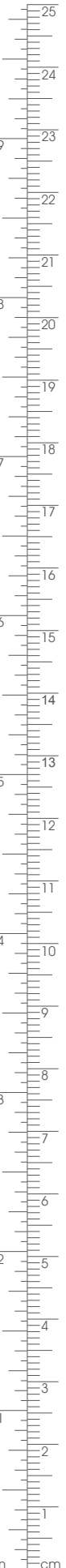
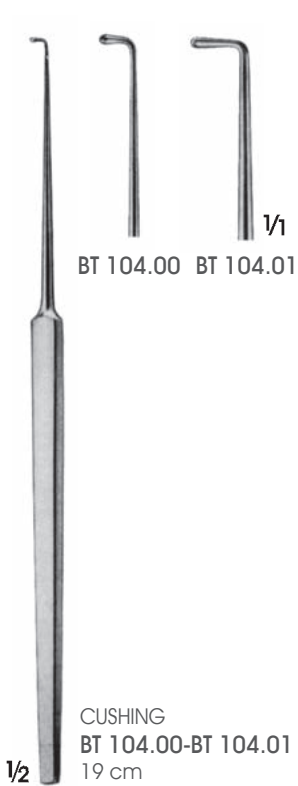
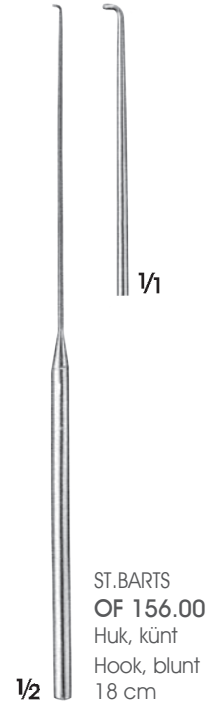
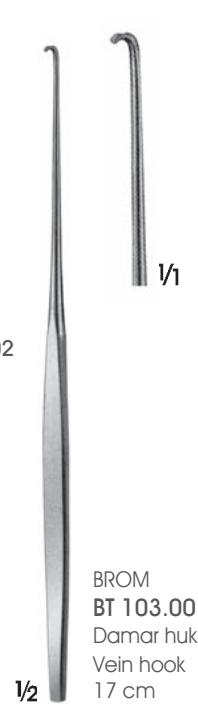
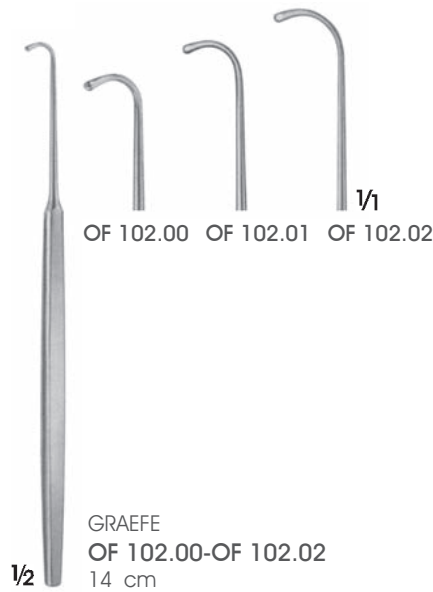

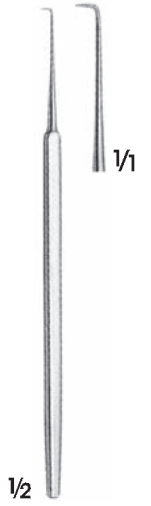

1/2
 CAIRNS
FF 117.00
 Dura ekartör
 Dura retractor
 13 cm



1/2
 GRAFE
OA 120.00 Sivri/Sharp
OA 121.00 Künt/Blunt
 12.5 cm



1/2
 FRAZIER
FF 122.00
 Dura ekartör
 Dura retractor
 13 cm



1/2
 GUTHRIE
OA 123.00 12.5 cm
OA 123.01 13 cm
 Sivri/Sharp

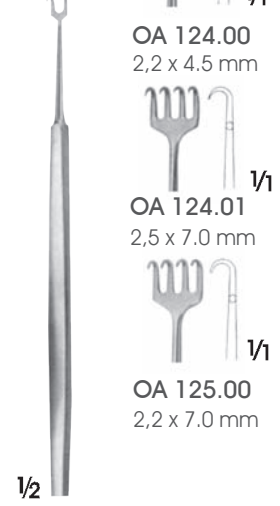

1/2
 ROLLET
OA 124.00 13 cm
OA 124.01 13.5 cm
 Sivri/Sharp
OA 125.00 13.5 cm
 Künt/Blunt



1/2
 MÜLLER
OL 130.00
 15 cm



1/2
 KILNER
OL 127.00
 16 cm



1/2
 FREER
OL 128.00
 15 cm



1/2
 MÜLLER
OL 131.00
 15 cm



1/2
 COTTLE
OL 133.00
 16 cm



JAGER
 OA 136.00
 13.5 cm

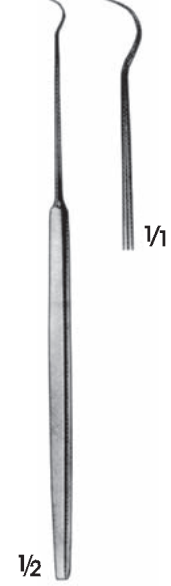

TÖNNIS
 FF 137.00
 Dura ekartör
 Dura retractor
 15 cm



COTTLE
 OL 134.00
 16 cm



FD 140.00
 Dura ekartör
 Dura retractor
 18.5 cm



GILLIES
 OL 138.00-OL 138.01
 18 cm

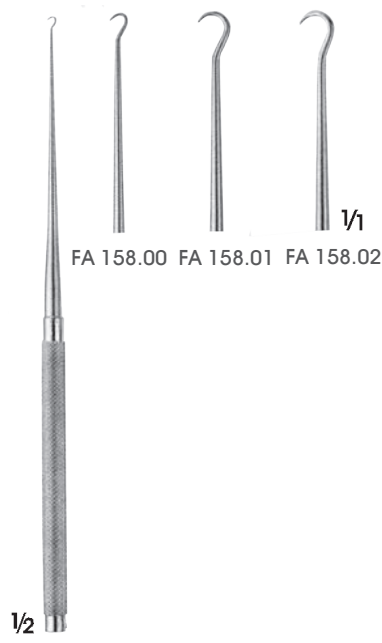

KLEINERT-KUTZ
 FA 158.00-FA 158.02
 16 cm



JOSEPH
 OL 143.00-OL 143.04
 16.5 cm





FISCH
FD 142.00
 Dura ekartör
 Dura retractor
 18.5 cm



MC INDOE
OL 148.00-OL 148.01
 15 cm



FD 145.00
 Doku piki/Tissue pick
 Doku ve deriyi yakalayıp
 kaldırmak için çift uçlu
 Double picks to grasp and
 lift skin, tissue etc
 18.5 cm

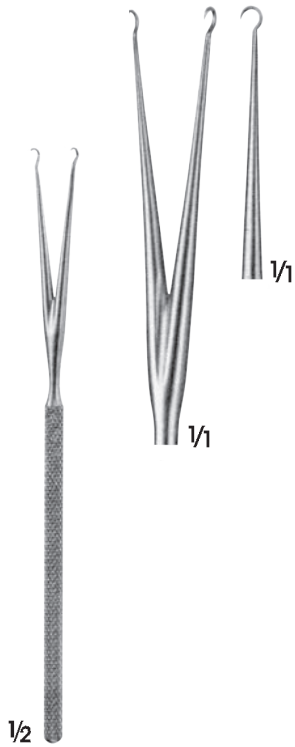

BARSKY
OL 149.00
 15.5 cm

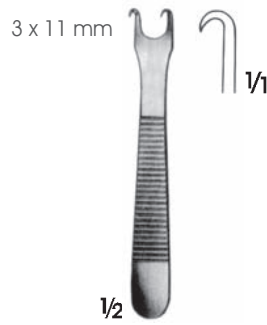

KILNER
OL 150.00
 Sivri/Sharp
 8 cm

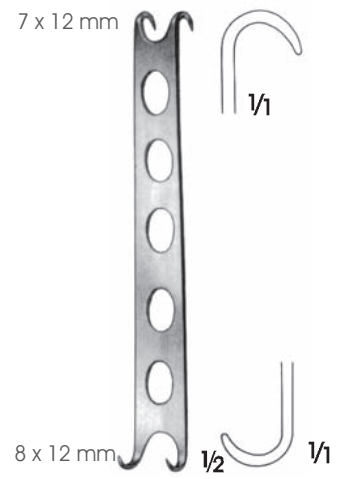

CONVERSE
OL 151.00
 Künt/Blunt
 12 cm

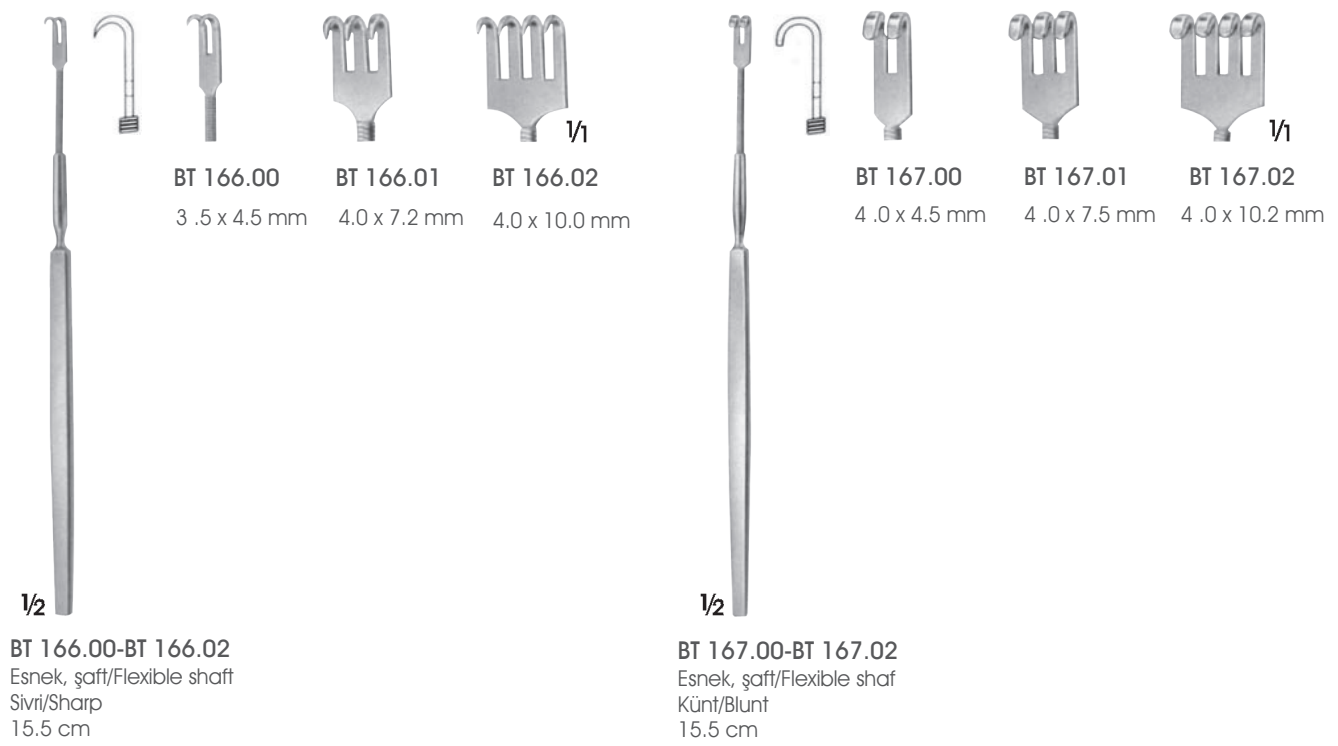
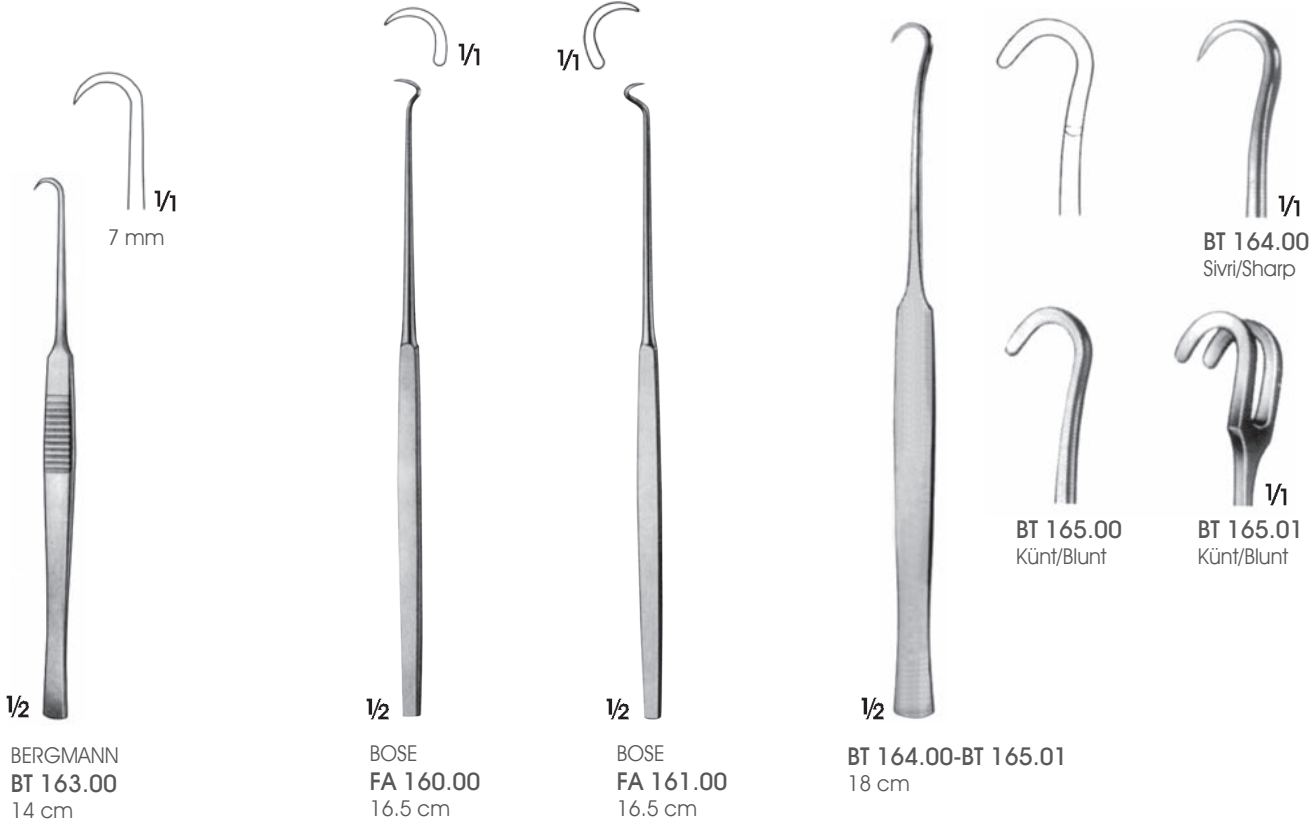

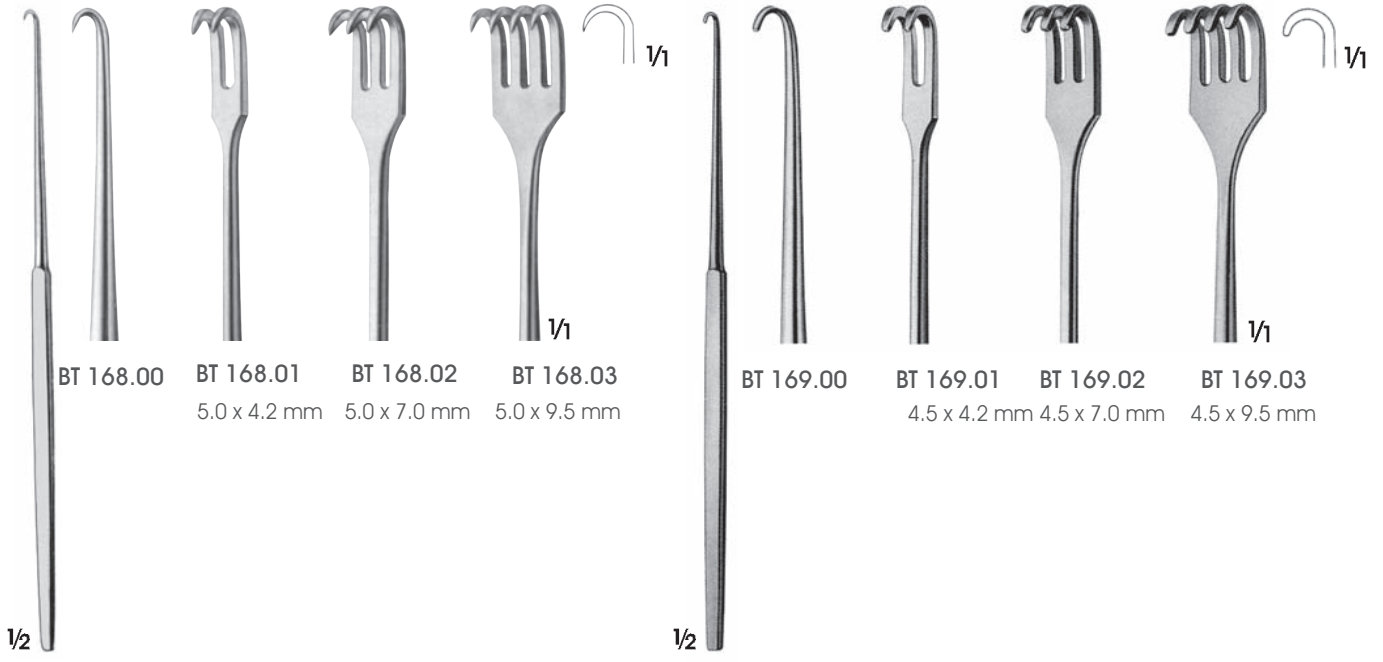

BT 168.00-BT 168.03 Sivri/
Sharp Küçük eğri/Small curve
16.5 cm

BT 169.00-BT 169.03 Künt/
Blunt Küçük eğri/Small curve
16.5 cm

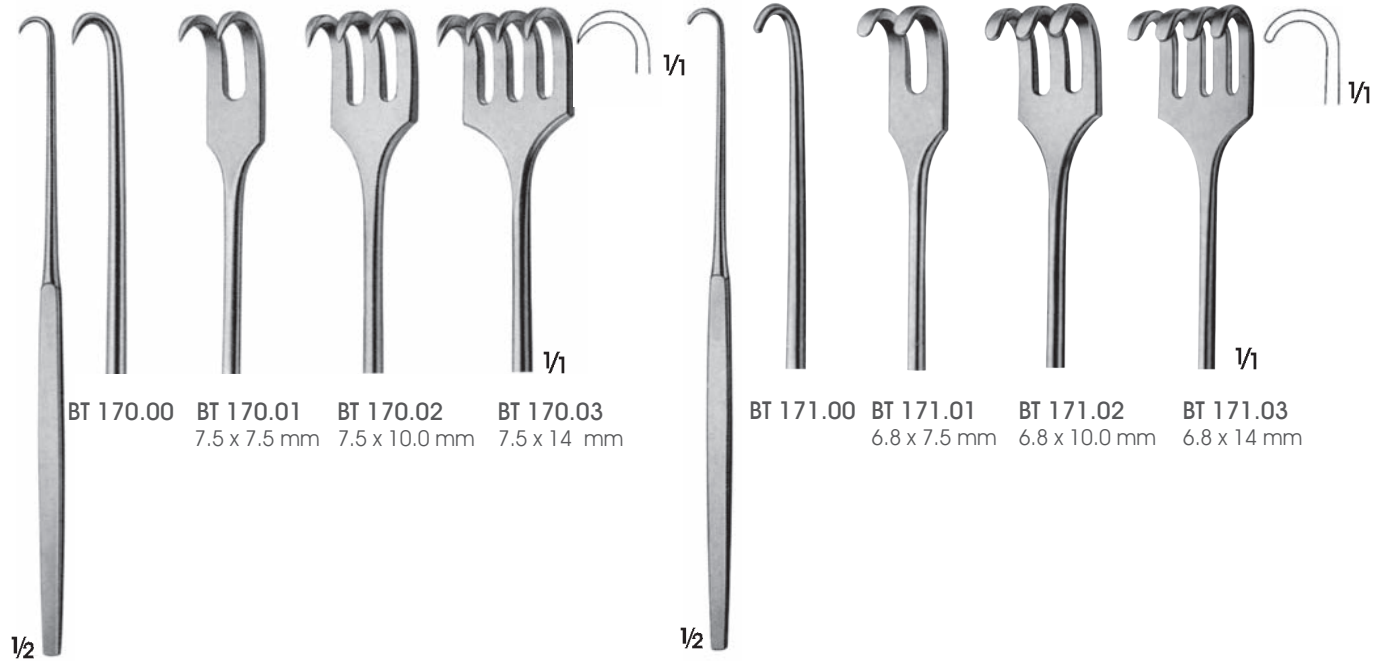

BT 170.00-BT 170.03 Sivri/
Sharp Büyük eğri/Large curve
16.5 cm

BT 171.00-BT 171.03
Künt/Blunt Büyük eğri/
Large curve
16.5 cm



MANNERFELT
BT 175.00
Sivri/Sharp
13.5 cm



MANNERFELT
BT 176.00
Sivri/Sharp
15.5 cm



MANNERFELT
BT 177.00
Sivri/Sharp
15.5 cm



MANNERFELT
BT 178.00
Esnek şaft küçük eğri, sivri
Flexible shaft, small curve, sharp
15.5 cm

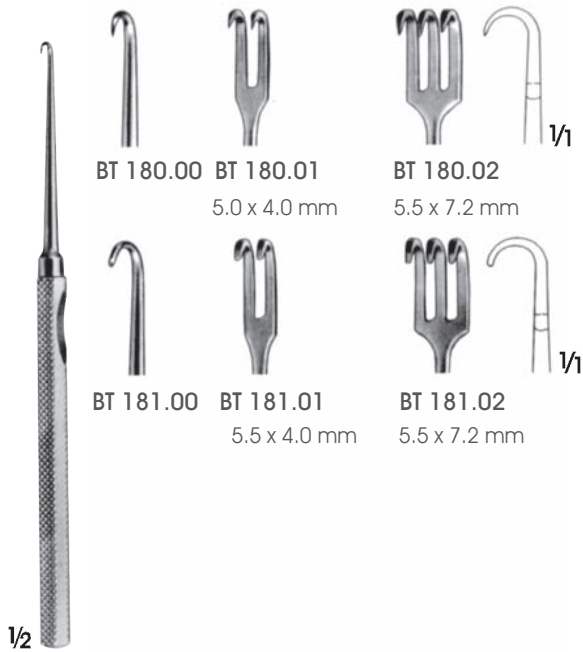

MANNERFELT
BT 180.00-BT 180.02 Sivri/Sharp
BT 181.00-BT 181.02 Künt/Blunt
Küçük eğri/Small curve
15.5 cm

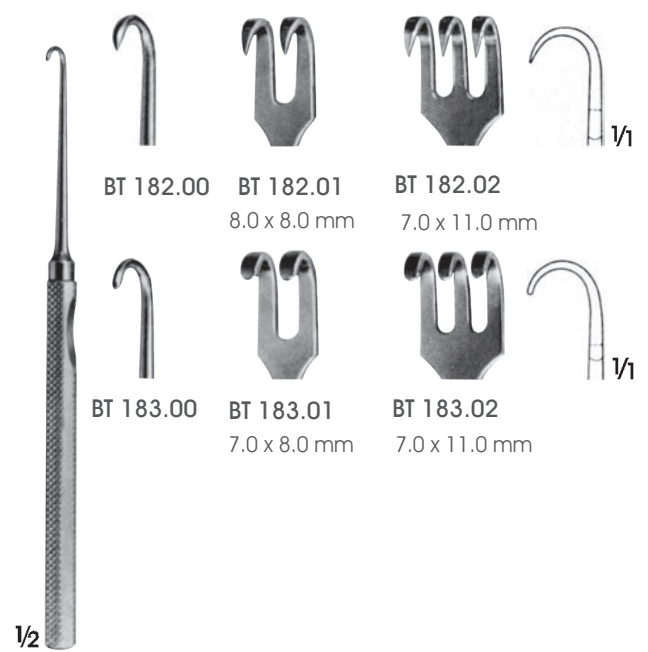

MANNERFELT
BT 182.00-BT 182.02 Sivri/Sharp
BT 183.00-BT 183.02 Künt/Blunt
Büyük eğri/Large curve
15.5 cm





1/2
MANNERFELT
BT 190.00
Oluklu/Hollow grooved
15.5 cm



1/2
LANGENBECK-MANNERFELT
BT 191.00-BT 191.03
15.5 cm

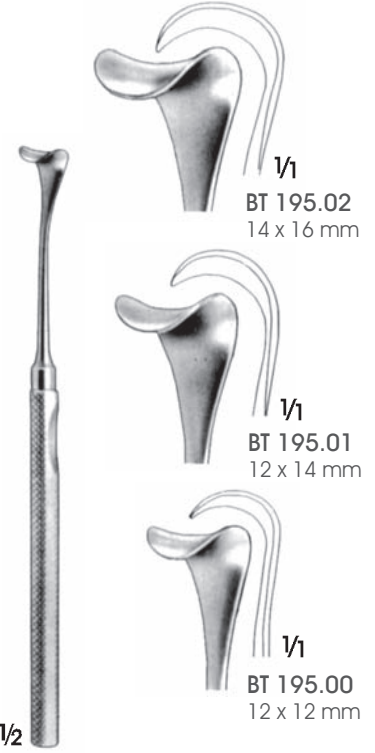

1/2
MANNERFELT
BT 195.00-BT 195.02
Eyer huklar/Saddle hooks
15.5 cm

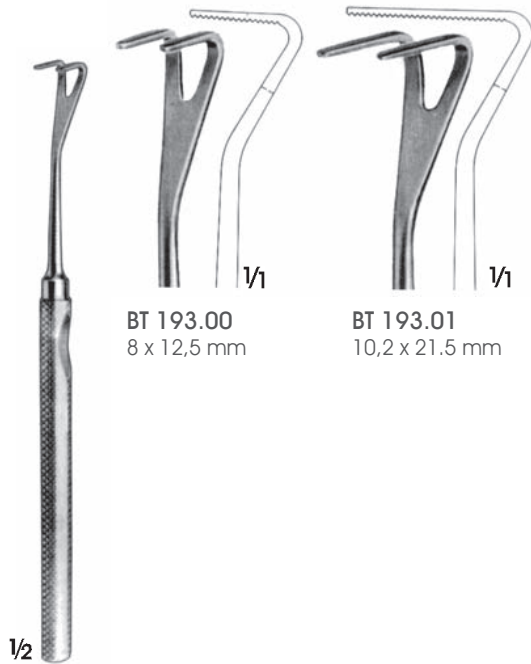

1/2
MANNERFELT
BT 193.00-BT 193.01
Geri eğimli çatallı huk
Forked hooks, retrograded
curved
15.5 cm



1/2
MANNERFELT
BT 196.00
Eyer huk, çerçevesi
Saddle hook, fenestrated
15.5 cm



1/2
MANNERFELT
BT 198.00
Tendon çift uçlu huk
Tendon double hook
16 cm

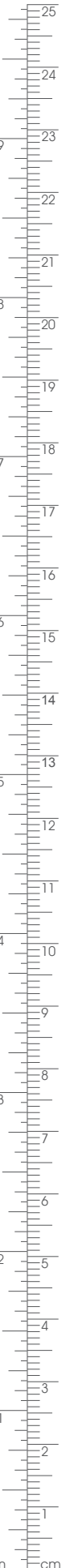
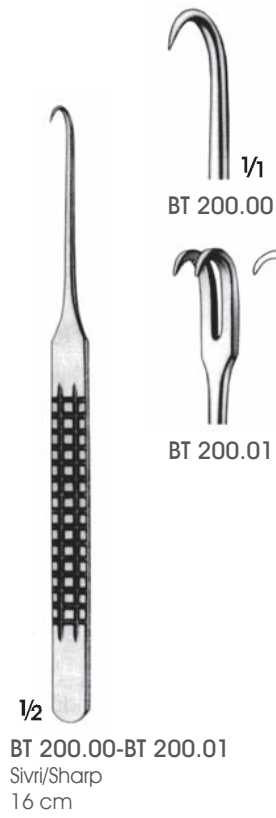

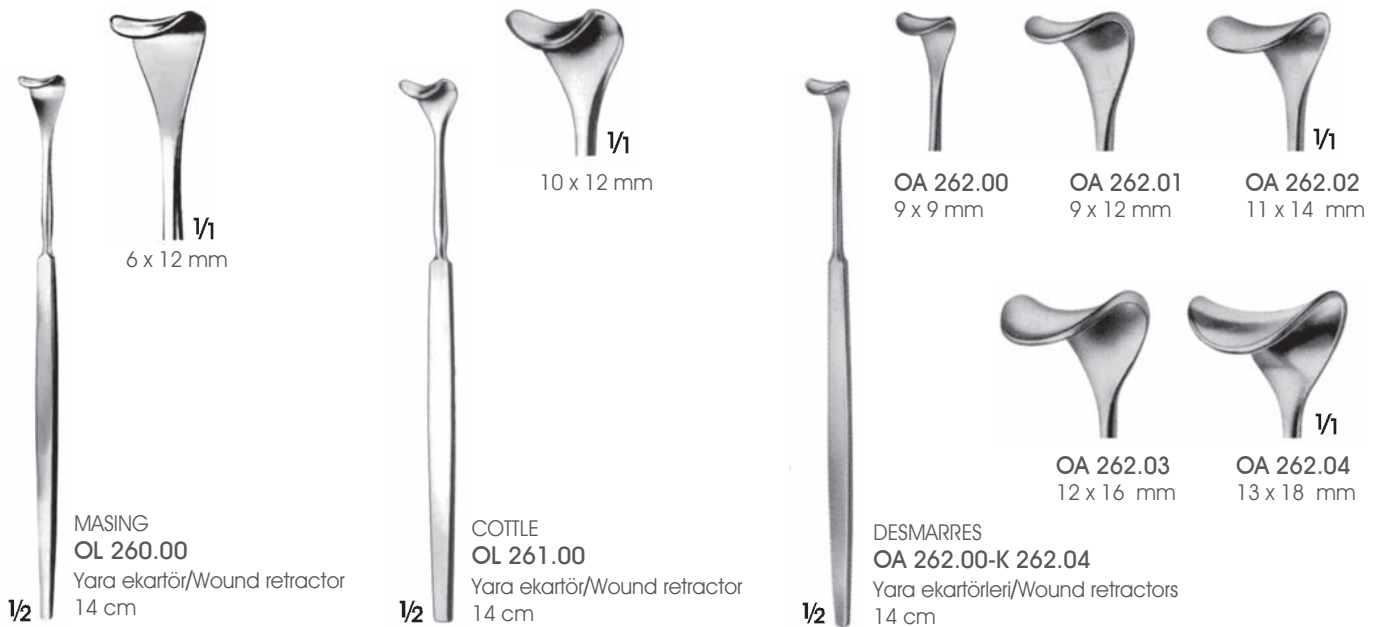

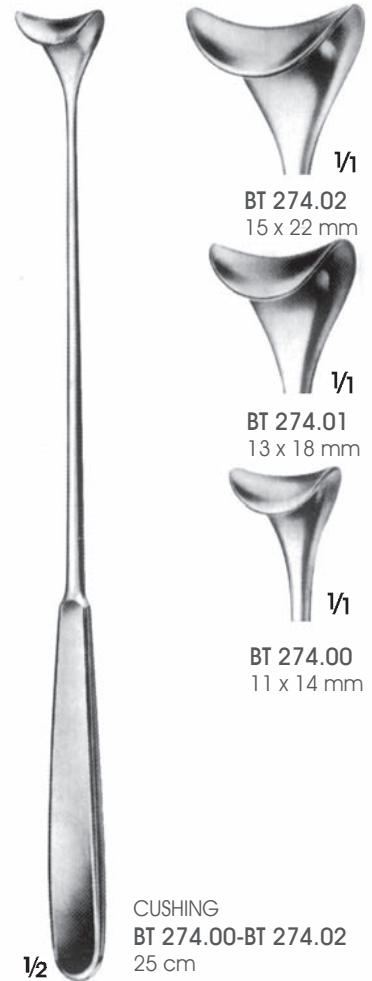
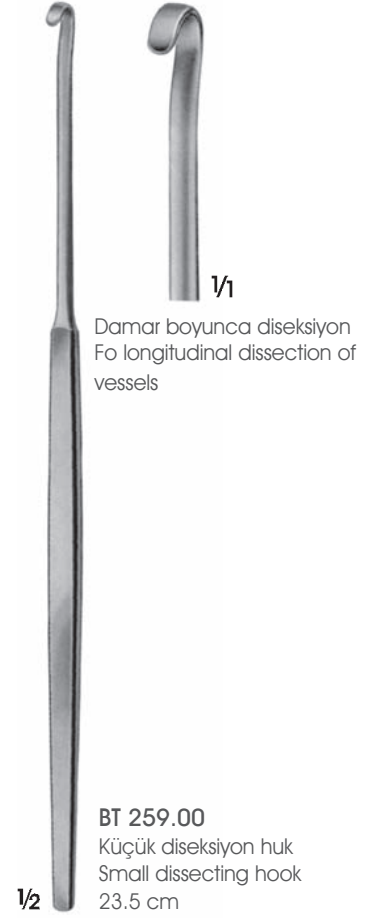



BT 230.02
18 x 7 mm

BT 230.01
16 x 5 mm

BT 230.00
7 x 4 mm

BT 230.05
5 x 10 mm

BT 230.04
11 x 4 mm

BT 230.03
6 x 4 mm

MEYERDING
BT 230.00-BT 230.05
18 cm



4 x 7 mm

DO 238.00

DO 238.01

DO 238.02

WILLIGER
DO 238.00-DO 238.02
Sivri/Sharp
12 cm

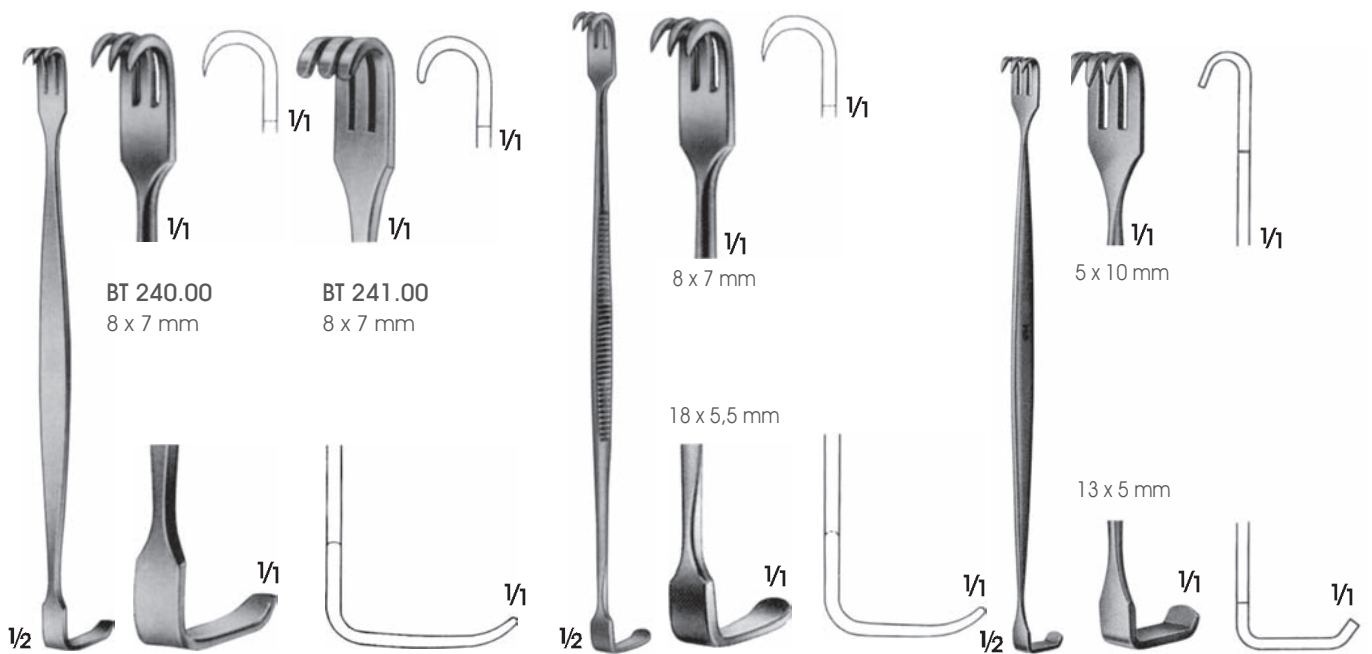

BT 240.00
8 x 7 mm

BT 241.00
8 x 7 mm

8 x 7 mm

5 x 10 mm

18 x 5,5 mm

13 x 5 mm

22 x 7 mm
BABY-SENN-MILLER
BT 240.00-BT 241.00
15.5 cm

SENN-MILLER
BT 242.00
16.5 cm

KILNER
BT 237.00
15.5 cm



PAUL
OA 244.00
Tendon huk/Tendon hook
12 cm



BT 246.00
12 x 6 mm

BT 246.01
12 x 11 mm

BT 246.00-BT 246.01
Tendon hukları/Tendon hooks
17.5 cm

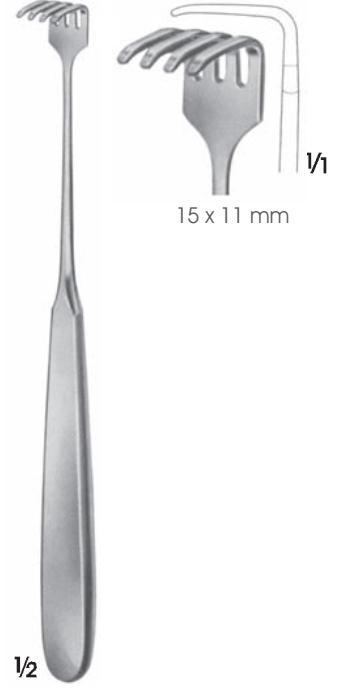

15 x 11 mm

KLAPP
BT 248.00
Tendon huk/Tendon hook
17.5 cm

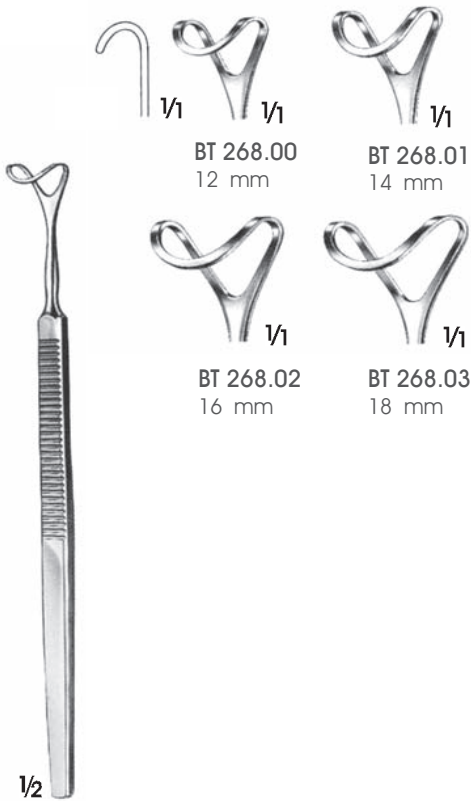

BT 268.00
12 mm

BT 268.01
14 mm

BT 268.02
16 mm

BT 268.03
18 mm

BT 268.00-BT 268.03 16
cm



BT 276.01
20 x 15 mm

BT 276.00
20 x 12 mm

KOCHER
BT 276.00-BT 276.01
20.5 cm



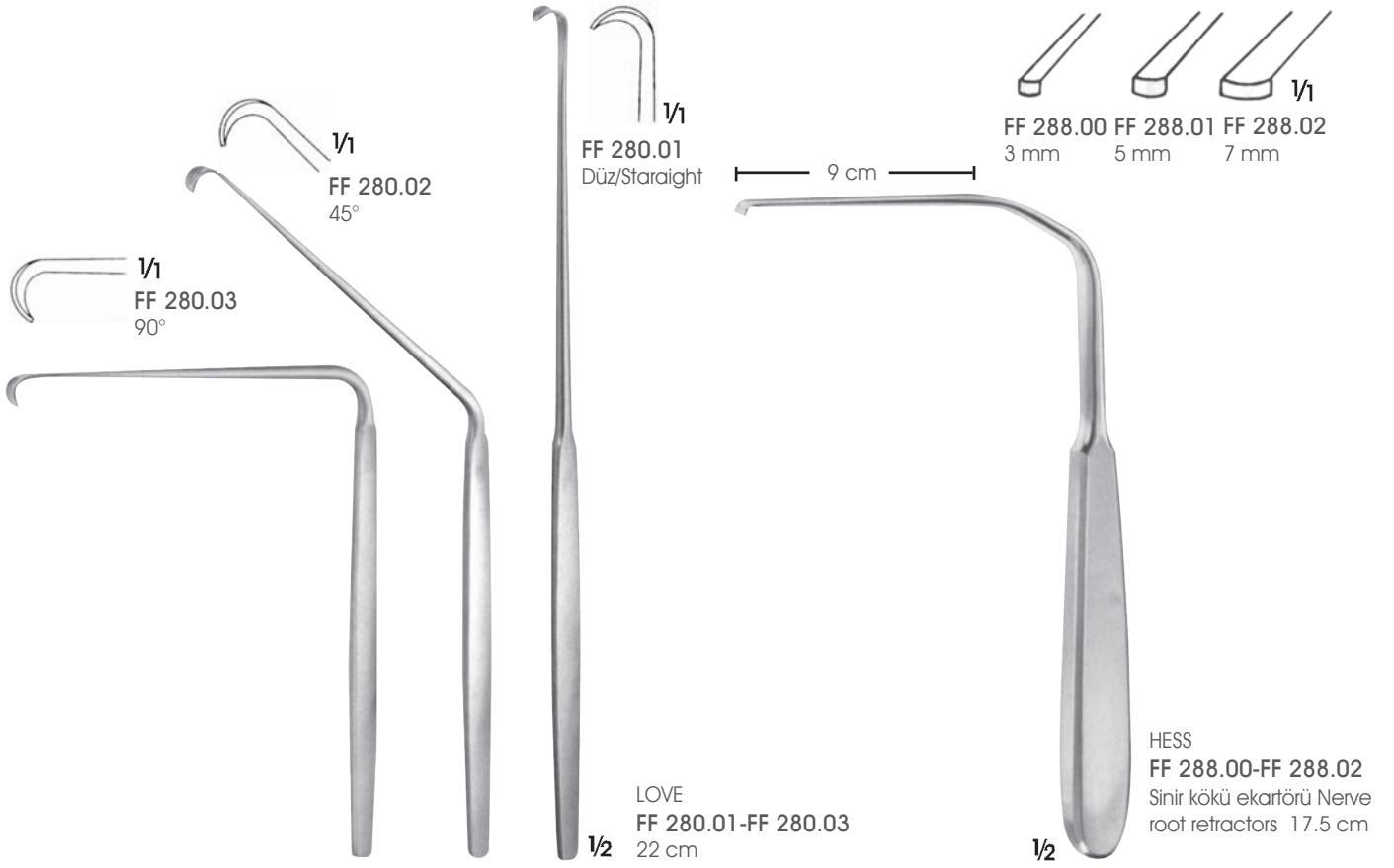

11 x 4 mm

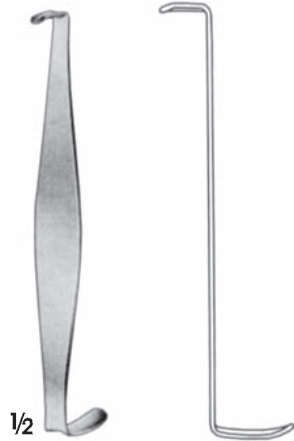

1/2

19 x 6 mm
CRILE
BT 300.00
11 cm

10 x 8 mm



1/2

12 x 11 mm
LUER
BT 301.00
11 cm

10 x 12 mm



1/2

11 x 15 mm
ROSE
BT 302.00
13 cm

5 x 3 mm



1/2

14 x 6.3 mm
RAGNELL
BT 304.00
15 cm

25 x 10 mm
22 x 10 mm



1/2

28 x 12 mm
32 x 12 mm
FARABEUF
BT 310.00
12.5 cm

23 x 16 mm
20 x 16 mm



1/2

24 x 16 mm
28 x 16 mm
FARABEUF
BT 311.00
15 cm

21 x 14 mm
17 x 14 mm



1/2

28 x 16 mm
32 x 16 mm
COLLIN
BT 312.00
15 cm

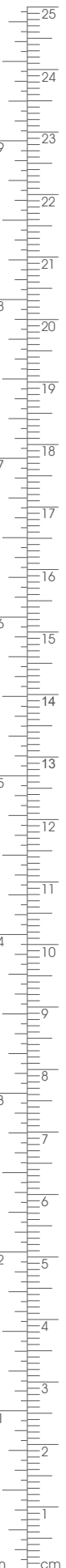

22 x 15 mm
18 x 15 mm

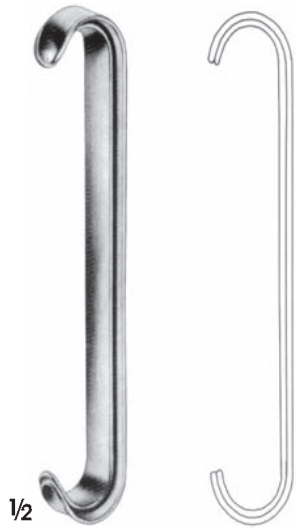

1/2

18 x 15 mm
22 x 15 mm
PARKER
BT 314.00
13.5 cm

17 x 16 mm

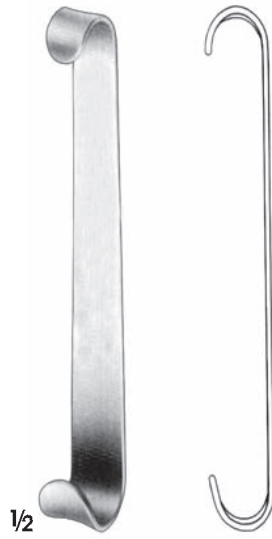

1/2

18 x 22 mm
BABY-ROUX
BT 315.00
13.5 cm

36 x 44 mm
30 x 24 mm



1/2

36 x 44 mm
30 x 24 mm
PARKER
BT 317.00
18 cm

20 x 22 mm

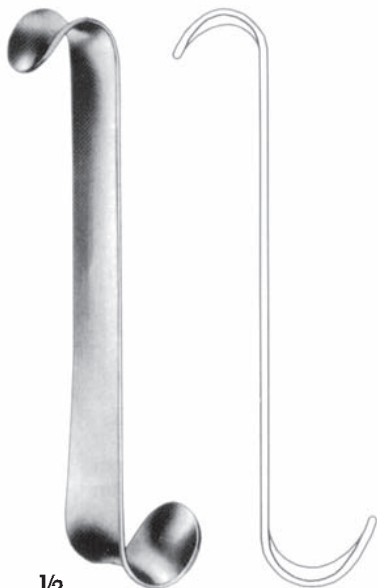

1/2

25 x 29 mm
ROUX
BT 320.00
15 cm

25 x 26 mm



1/2

30 x 38 mm
ROUX
BT 320.01
16 cm

28 x 29 mm



1/2

33 x 44 mm
ROUX
BT 320.02
17 cm

30 x 19 mm

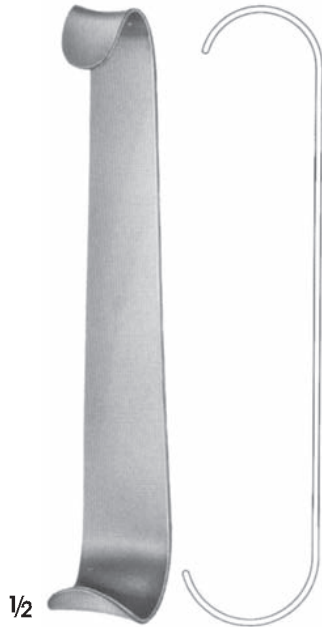

33 x 25 mm
KILNER
BT 322.01
15 cm

35 x 29 mm

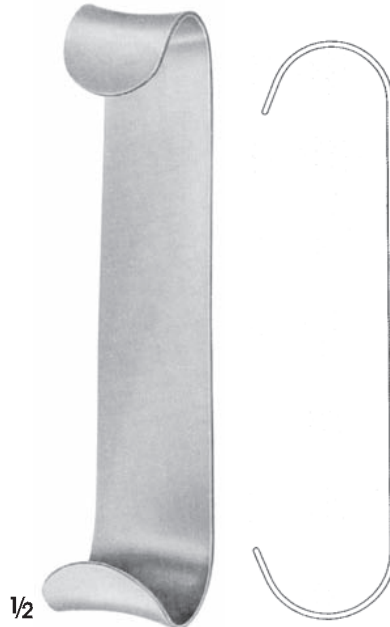

40 x 35 mm
KILNER
MD 333.00
15 cm



1/2
GOELET
MD 332.00
19 cm

19 x 22 mm



1/2
23 x 30 mm
BT 325.01

25 x 26 mm



1/2
28 x 38 mm
BT 325.02

28 x 29 mm



1/2
33 x 45 mm
BT 325.03



ROUX
BT 325.00
Komple/Complete
BT 325.01-BT 325.03
16.5 cm

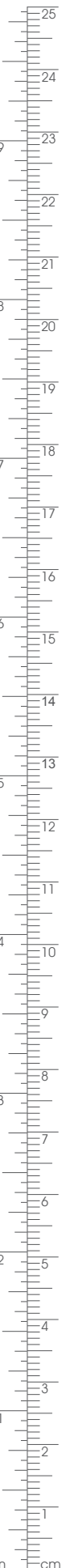

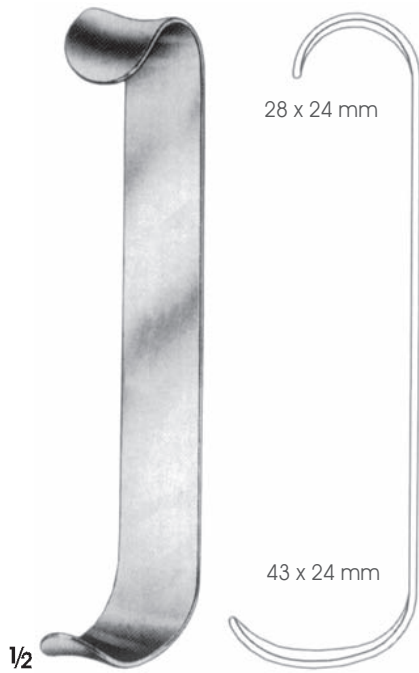

ROUX
BT 327.00
17 cm

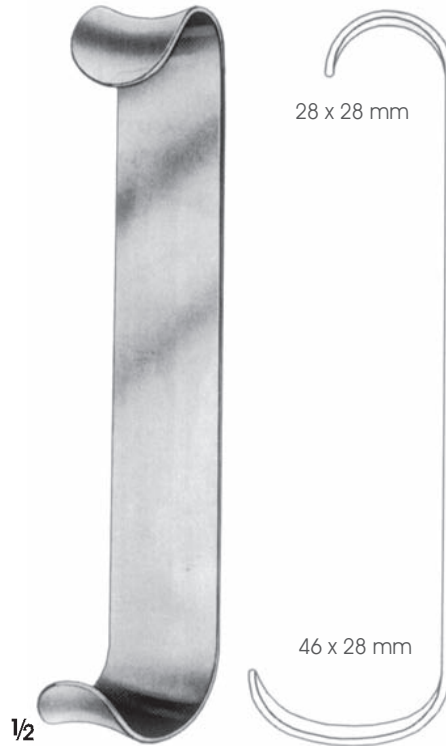

ROUX
BT 327.01
19 cm

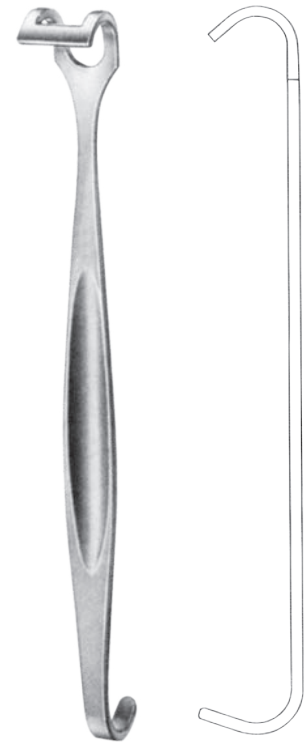

CANNY-RYALL
BT 339.01 16 mm 19 cm
BT 339.02 20 mm 19 cm
BT 339.03 25 mm 20 cm

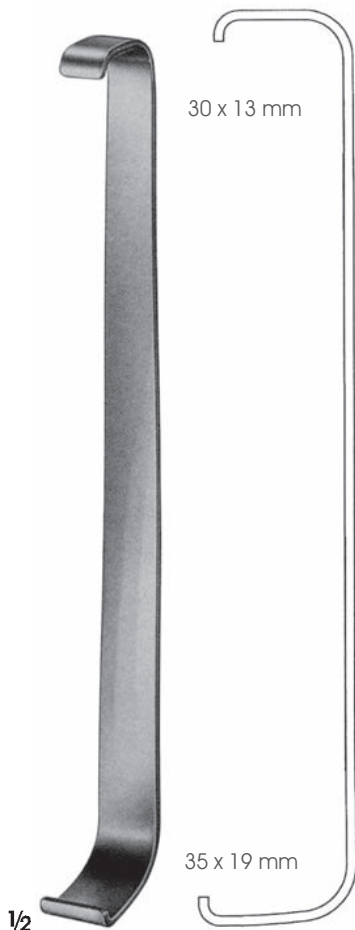

LANE
BT 328.00
23 cm

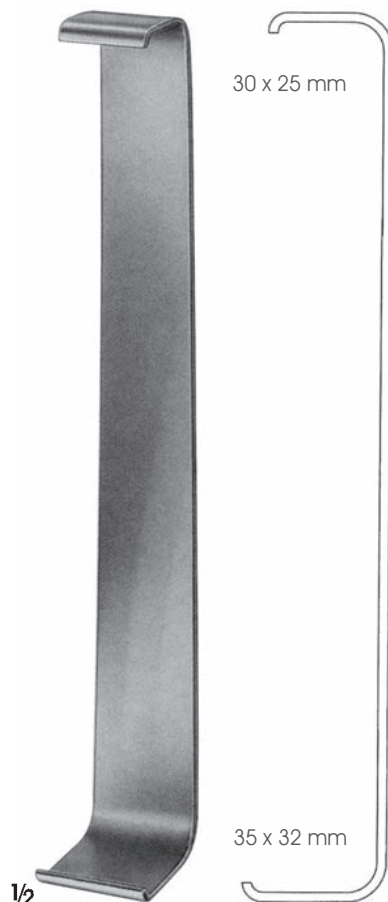

LANE
BT 328.01
23 cm



HAJEK
BT 337.01
16.5 cm

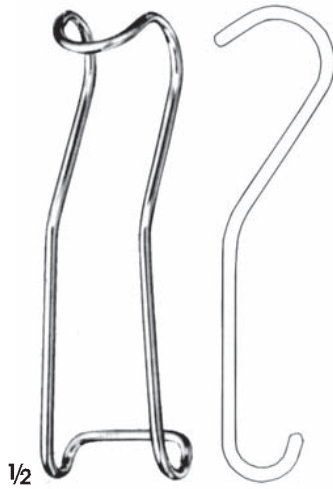

1/2

STERNBERG
OM 346.00 12 cm
OM 346.01 13 cm
OM 346.02 13.5 cm

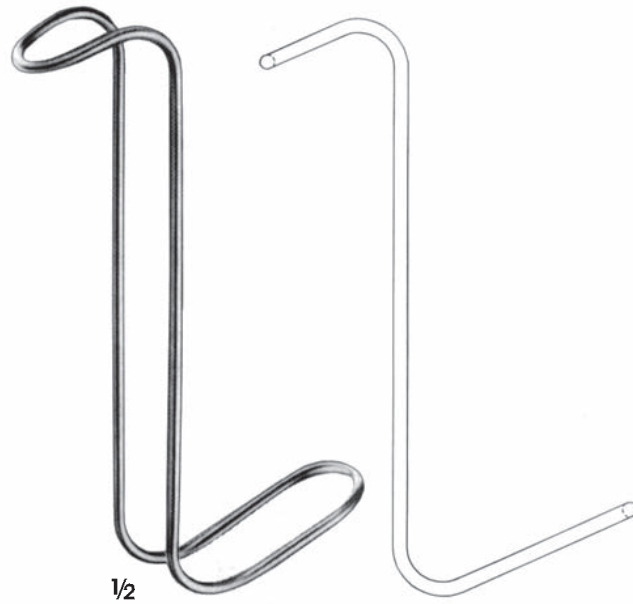

1/2

COLLIN-HARTMANN
BT 348.00
15 cm

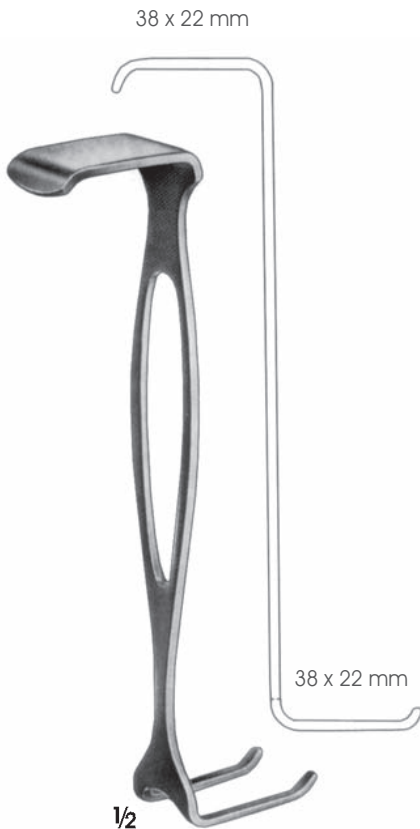

1/2

CZERNY
BT 340.00
17.5 cm



1/2

MATHIEU
BT 341.00
20 cm



1/2

US-ARMY
BT 342.00
22 cm



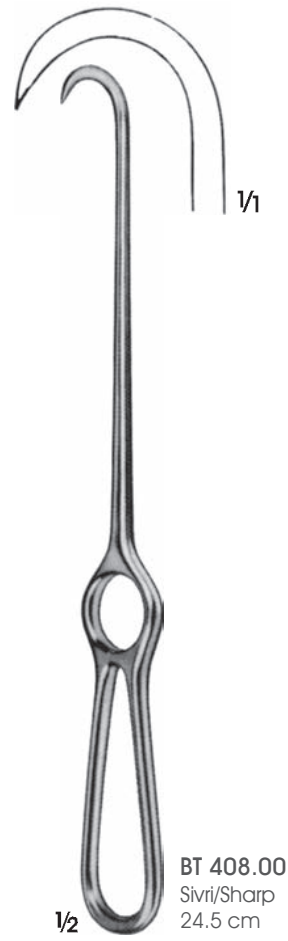



1/2

VOLKMANN
BT 430.00-BT 430.03
BT 431.00-BT 431.03
22.5 cm



1/2

VOLKMANN
BT 432.00-BT 432.04
BT 433.00-BT 433.04
BT 434.00-BT 434.04
22 cm





BT 435.00
16 x 9 mm



BT 435.01
16 x 14 mm



BT 435.02
16 x 20 mm



BT 435.03
16 x 30 mm

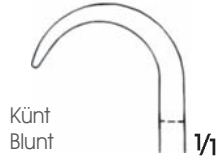

BT 436.00
15.5 x 9 mm



BT 436.01
15.5 x 14 mm



BT 436.02
15.5 x 20 mm



BT 436.03
15.5 x 30 mm

KOCHER
BT 435.00-BT 435.03
BT 436.00-BT 436.03
22 cm

1/2



BT 437.00
8 dişli, yarı sivri
8 prongs, semi-sharp



BT 438.00
8 dişli, künt
8 prongs, blunt

KÖRTE
BT 437.00-BT 438.00 Dikey
saplı bleyd
Handle vertical to the blade
24 cm

1/2

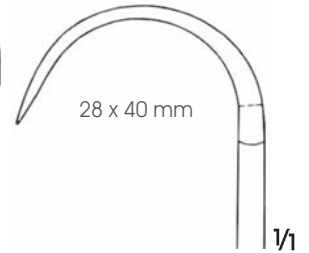

KÖRTE- WAGNER
BT 439.00
8 dişli, yarı sivri
8 prongs, semi sharp
28 cm

1/2

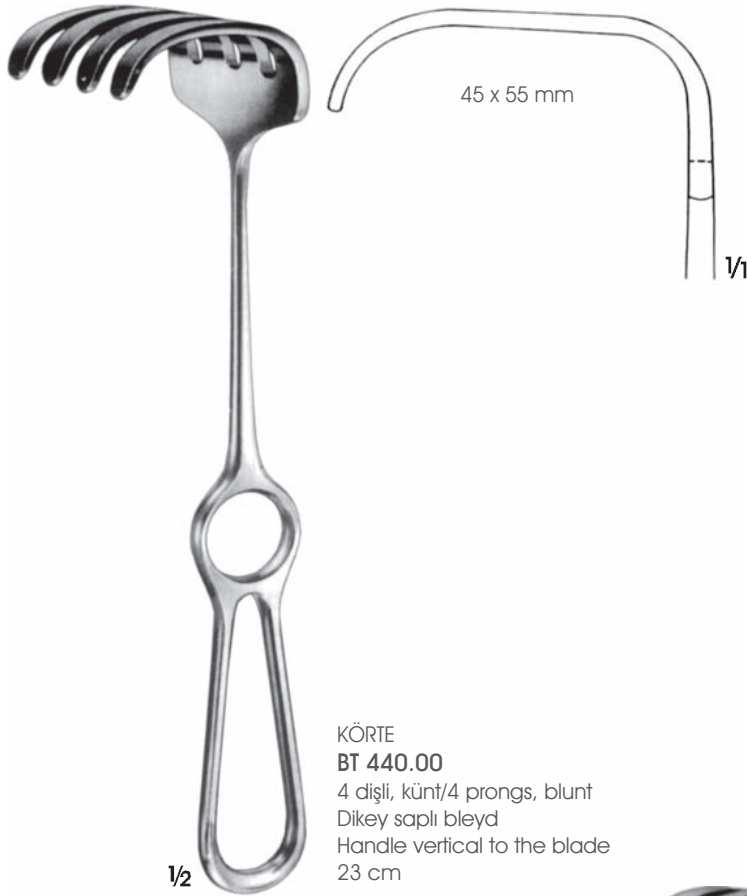

KÖRTE
BT 440.00
4 dişli, künt/4 prongs, blunt
Dikey saplı bleyd
Handle vertical to the blade
23 cm



OLLIER
BT 442.00
4 dişli, künt
4 prongs, blunt
23 cm

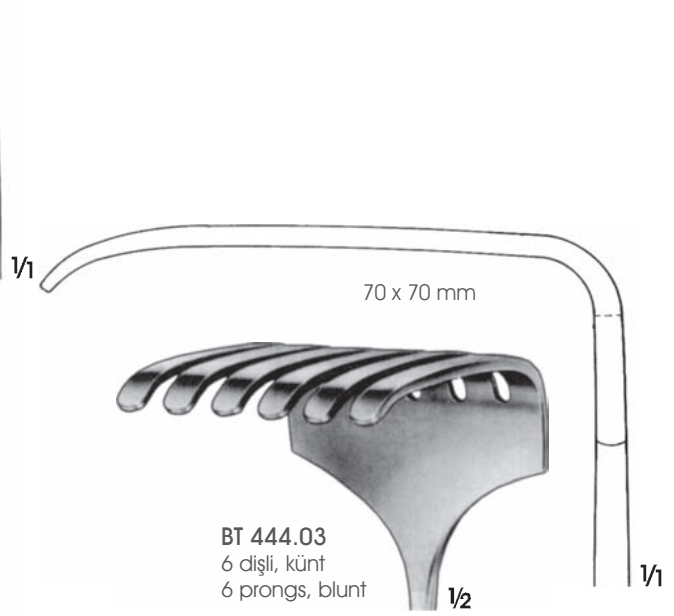

BT 444.03
6 dişli, künt
6 prongs, blunt

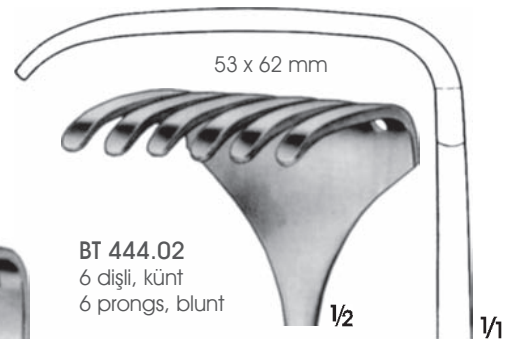

BT 444.02
6 dişli, künt
6 prongs, blunt

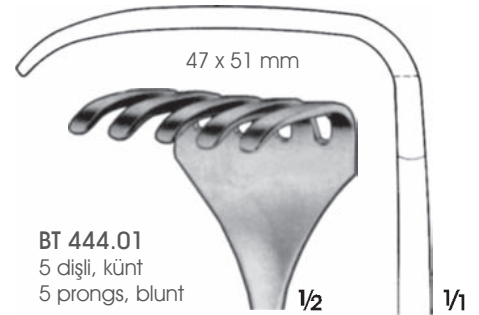

BT 444.01
5 dişli, künt
5 prongs, blunt

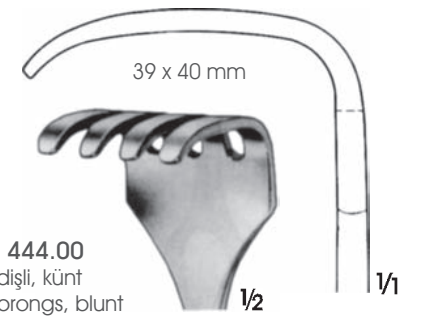

BT 444.00
4 dişli, künt
4 prongs, blunt



ISRAEL
BT 444.00-BT 444.03
25.5 cm

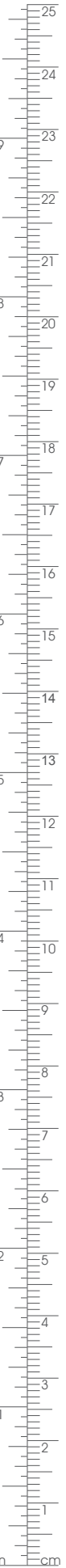



1/2

MURPHY
BT 448.00-BT 448.11
19.5 cm



BT 448.00
Sivri/Sharp



BT 448.01
Sivri/Sharp



BT 448.10
Künt/Blunt



BT 448.11
Künt/Blunt



1/2

LANGENBECK
BT 450.01-BT 450.03 23
cm

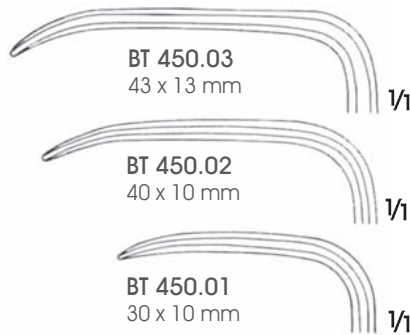

BT 450.03
43 x 13 mm

1/1

BT 450.02
40 x 10 mm

1/1

BT 450.01
30 x 10 mm

1/1



1/2

LANGENBECK
BT 451.01-BT 451.06
21 cm

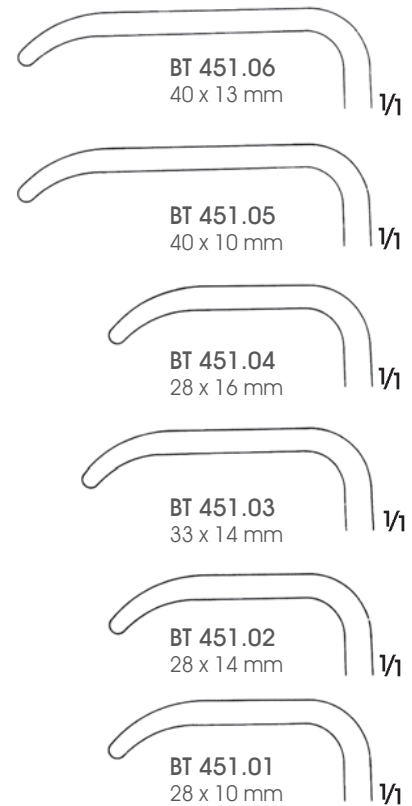

BT 451.06
40 x 13 mm

1/1

BT 451.05
40 x 10 mm

1/1

BT 451.04
28 x 16 mm

1/1

BT 451.03
33 x 14 mm

1/1

BT 451.02
28 x 14 mm

1/1

BT 451.01
28 x 10 mm

1/1



1/2

KOCHER-LANGENBECK
BT 452.01-BT 452.10
21.5 cm

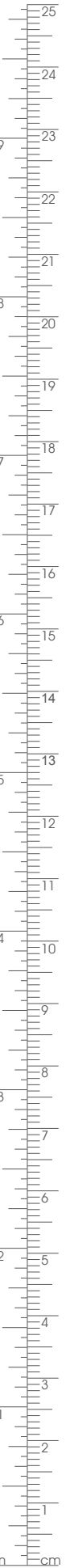
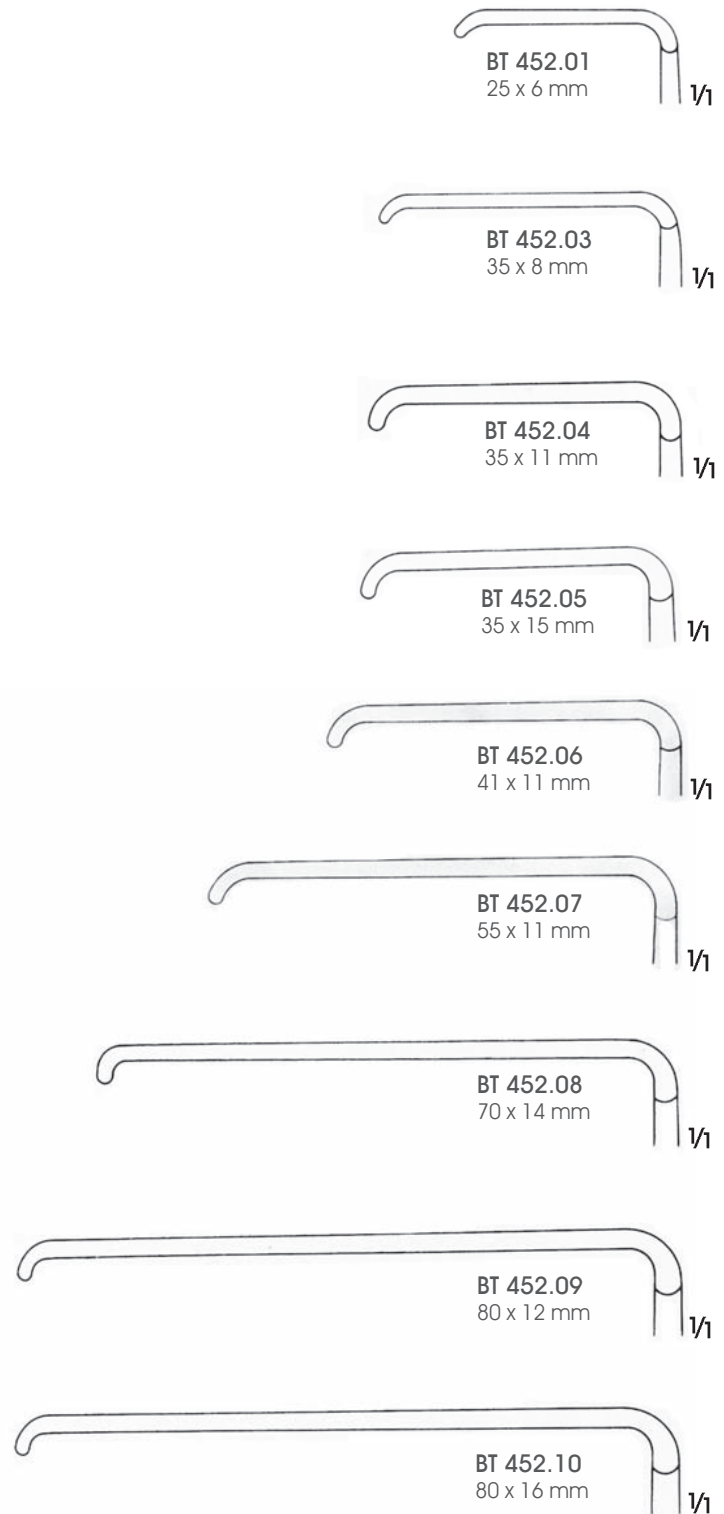



1/2 BT 453.00
21 cm



BT 454.00-BT 454.01

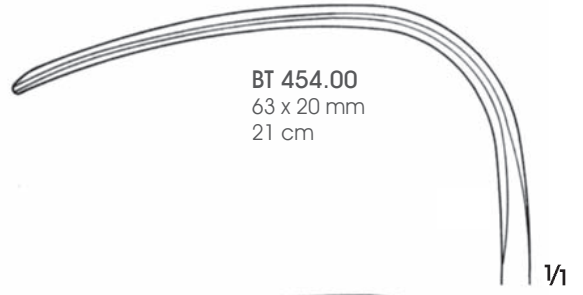

BT 454.00
63 x 20 mm
21 cm

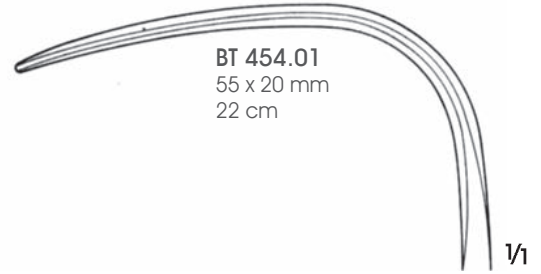

BT 454.01
55 x 20 mm
22 cm

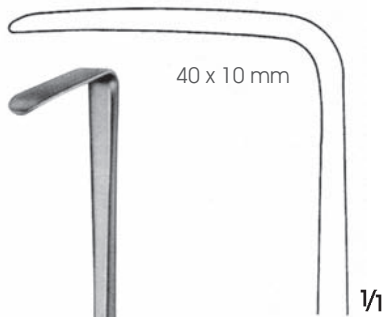

1/2 BT 455.00
21.5 cm



1/2 LANGENBECK
BT 456.00
Dikey saplı bleyd
Handle vertical to the blade
21.5 cm



1/2

OBWEGESER
DO 457.00-DO 457.05
21.5 cm

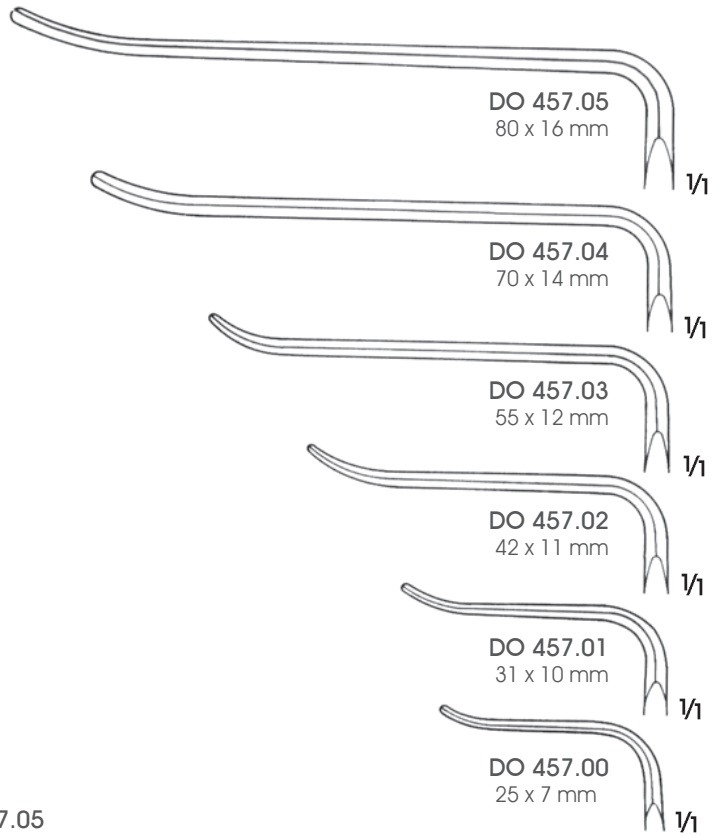

1/2

OBWEGESER
DO 458.00-DO 458.05
21.5 cm

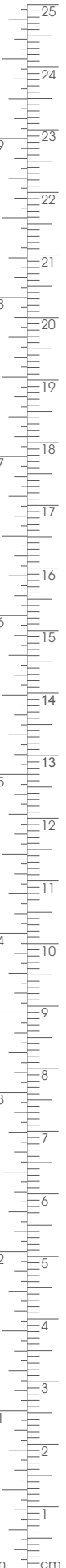
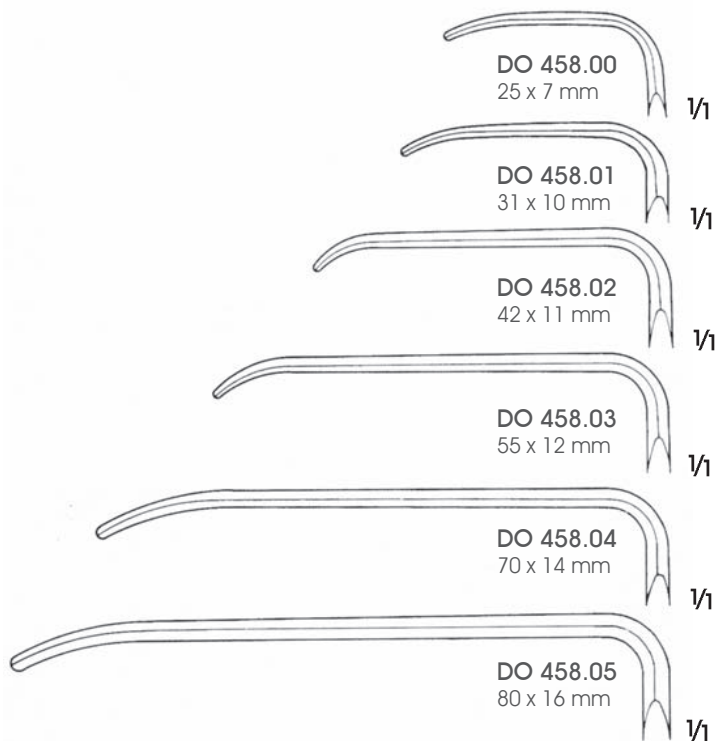



KOCHER
BT 460.00-BT 460.04
23 cm

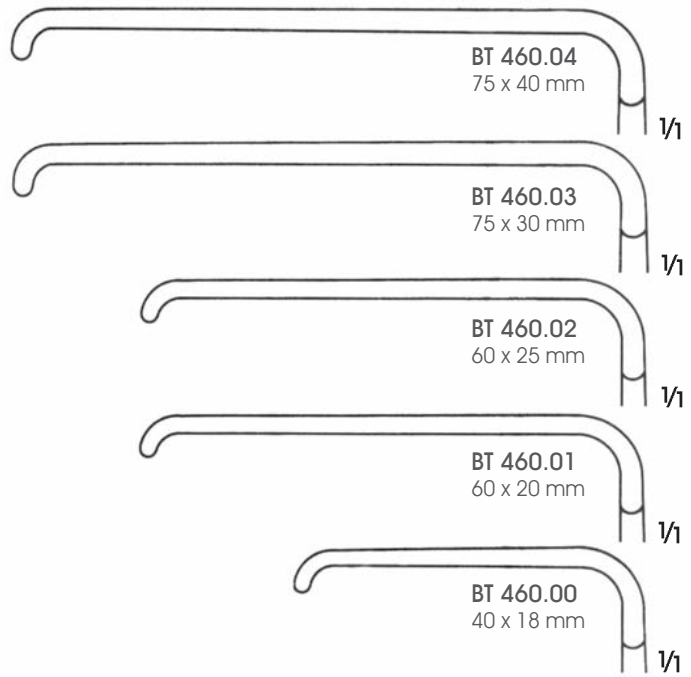

SAUERBRUCH
BT 461.00-BT 461.02
22.5 cm

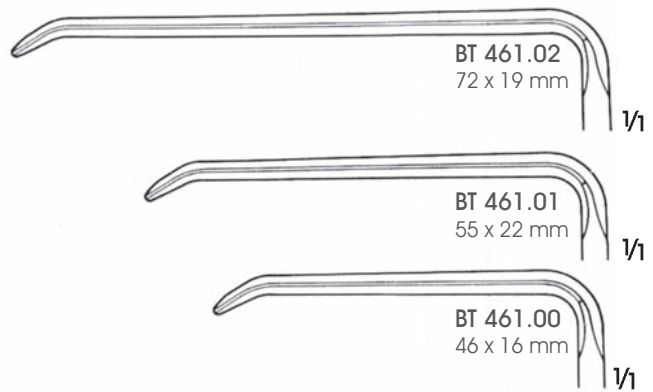

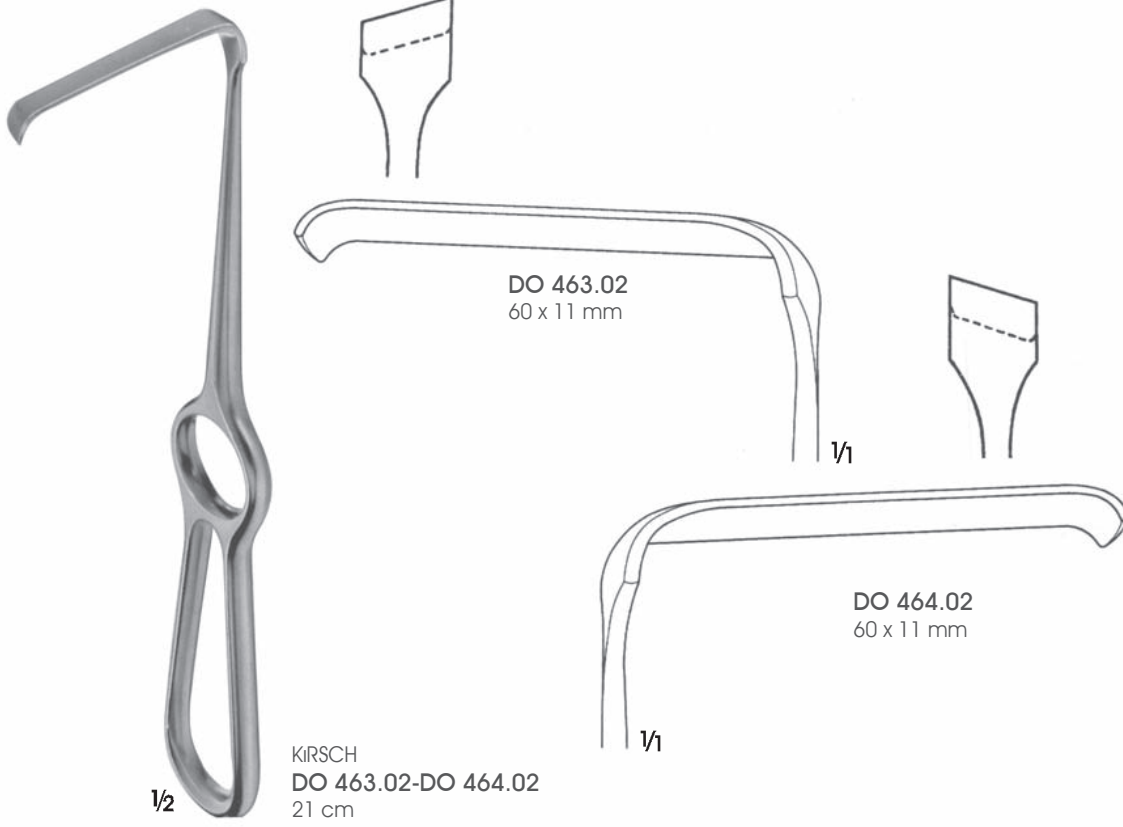

1/2

KIRSCH
DO 463.02-DO 464.02
21 cm

DO 463.02
60 x 11 mm

DO 464.02
60 x 11 mm



1/2

SCHULZ
DO 466.00-DO 466.01
Emiş tertibatlı ekartör, ufak ameliyatlarda ve tek elle kullanılır.
Retractor with suction device, for one-handed operation in minor surgery.

DO 466.01
53 x 15 mm
22.5 cm

DO 466.00
59 x 20 mm
21.5 cm

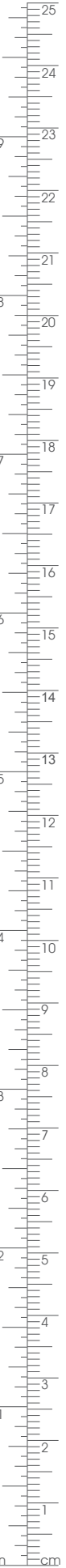

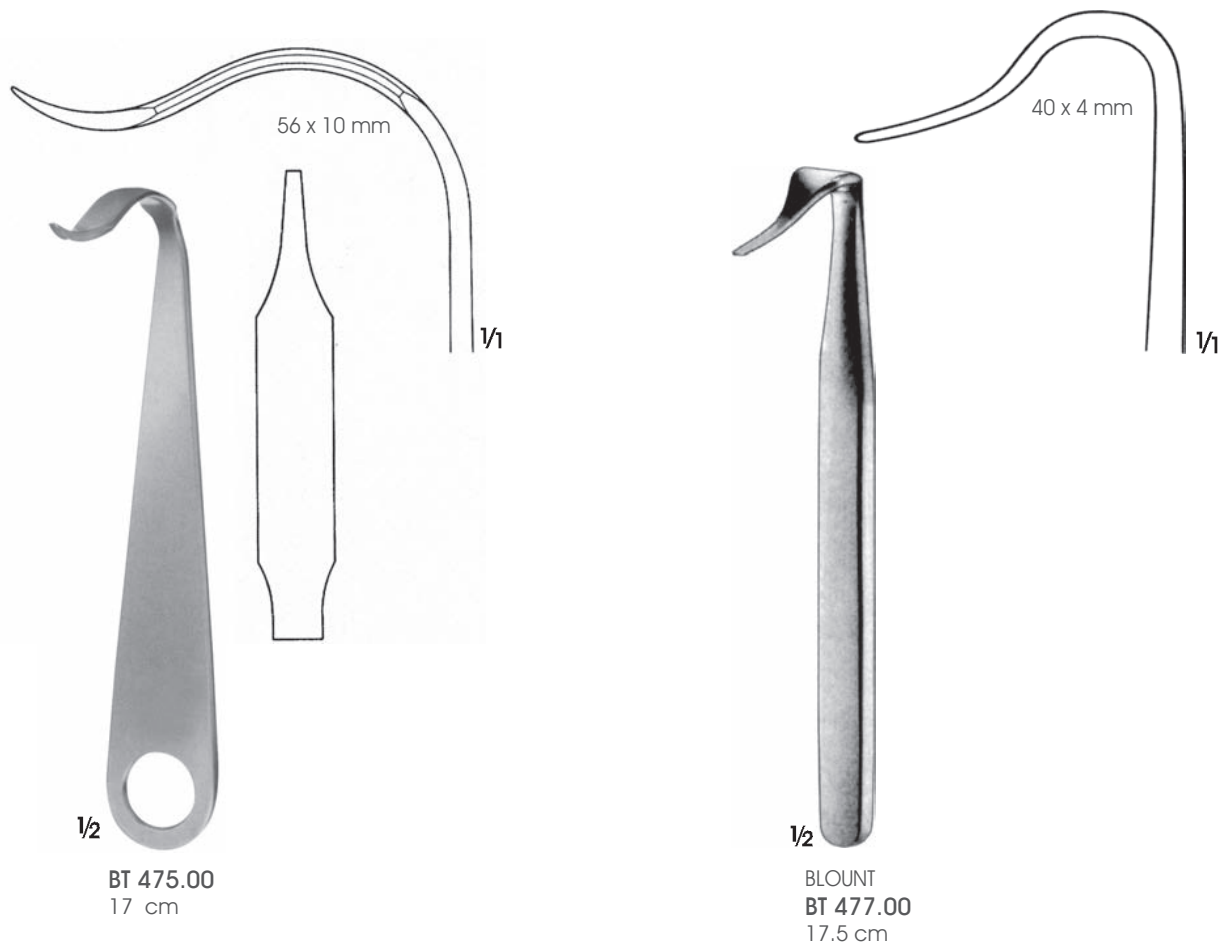
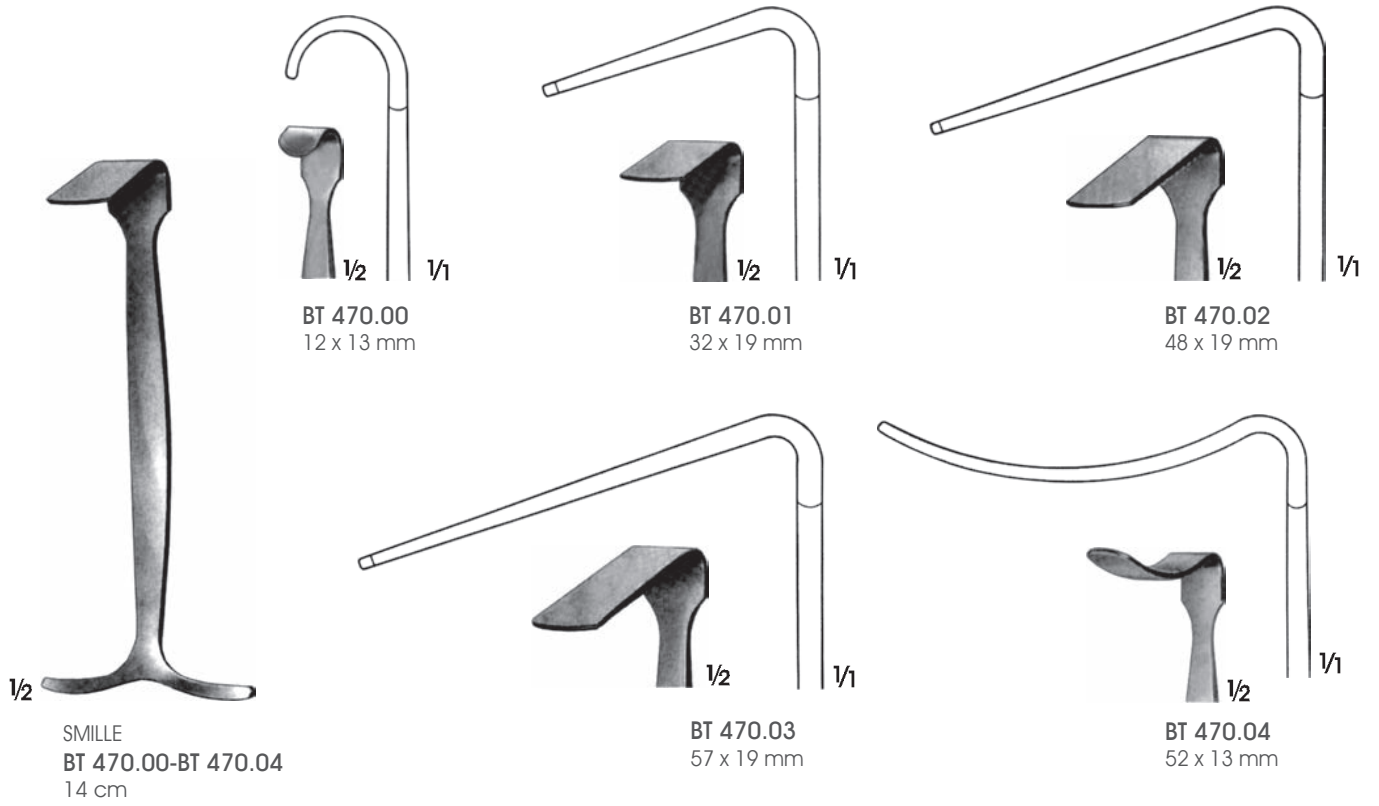

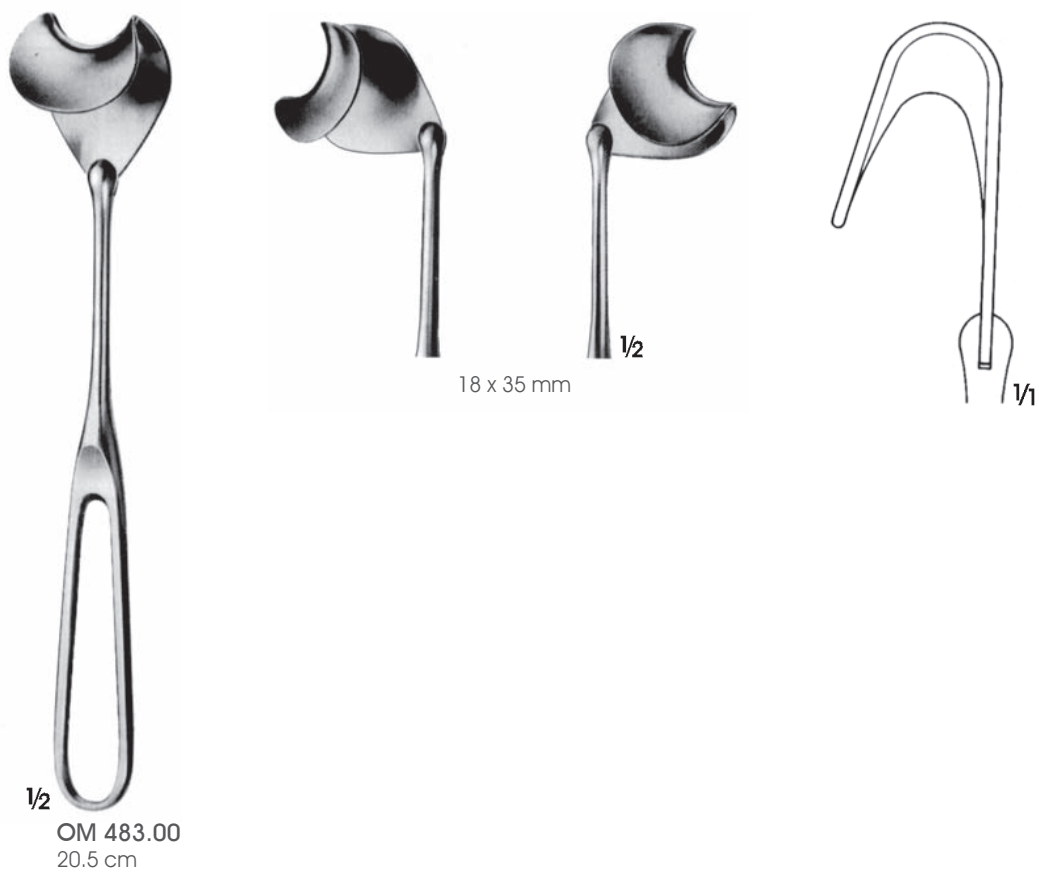



MIDDELDORPF
BT 480.00-BT 480.02



BT 480.00
15 x 15 mm
22 cm

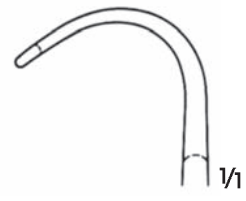

BT 480.01
20 x 22 mm
21.5 cm

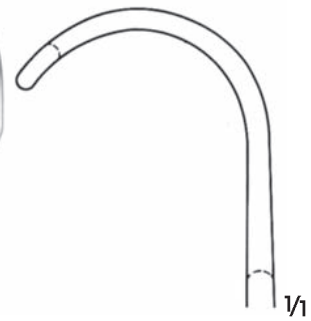

BT 480.02
28 x 28 mm
23.5 cm



1/2

GREENE
BT 481.00
22.5 cm



22 x 22 mm

1/1



1/2

DURHAM
BT 482.00
21.5 cm



16 x 25 mm

1/1



1/2

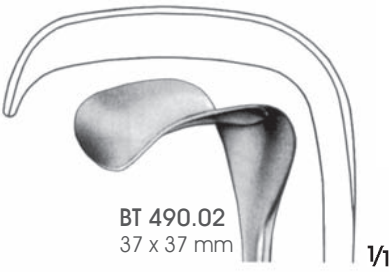

BT 490.02
37 x 37 mm

1/1



BT 490.01
30 x 29 mm

1/1



BT 490.00
23 x 20 mm

1/1

RICHARDSON
BT 490.00-BT 490.02
24 cm

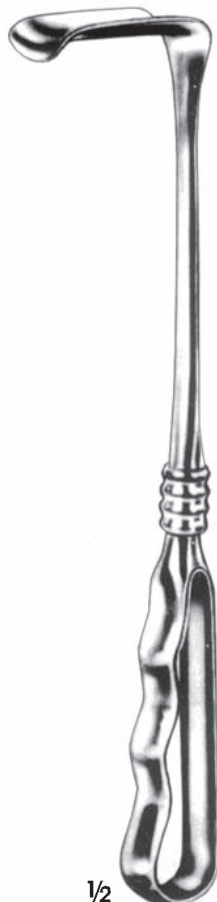

1/2

RICHARDSON
BT 491.00
24 cm

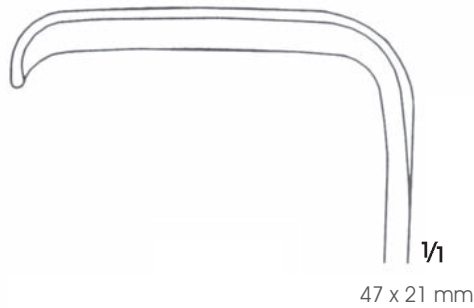

1/1

47 x 21 mm

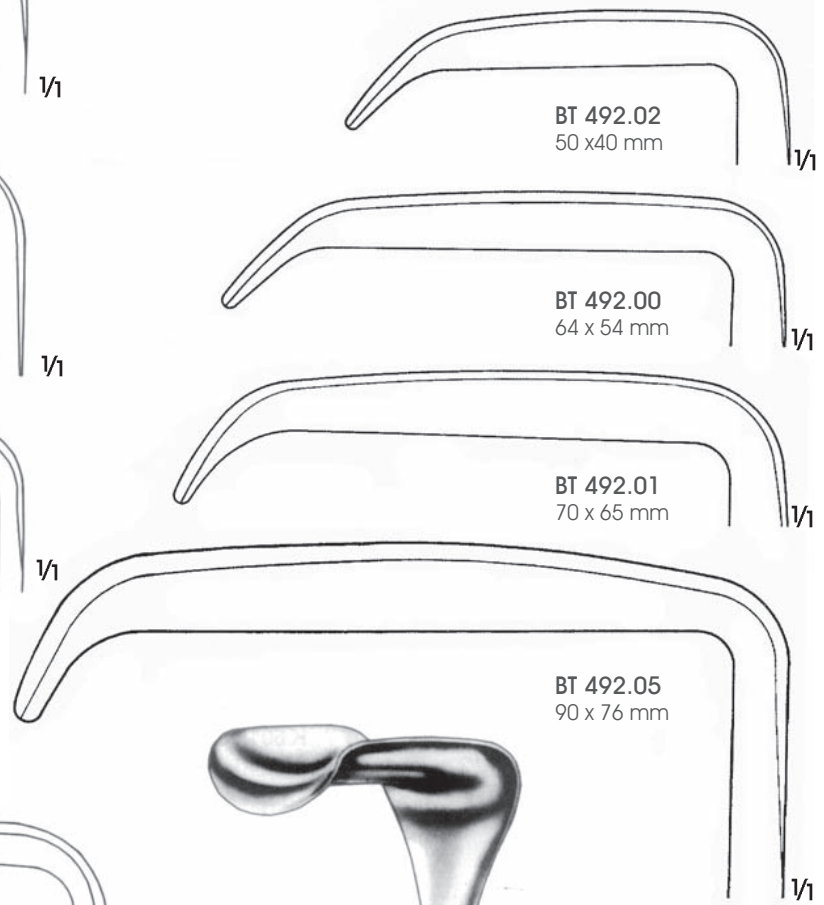

BT 492.02
50 x 40 mm

1/1

BT 492.00
64 x 54 mm

1/1

BT 492.01
70 x 65 mm

1/1

BT 492.05
90 x 76 mm

1/1

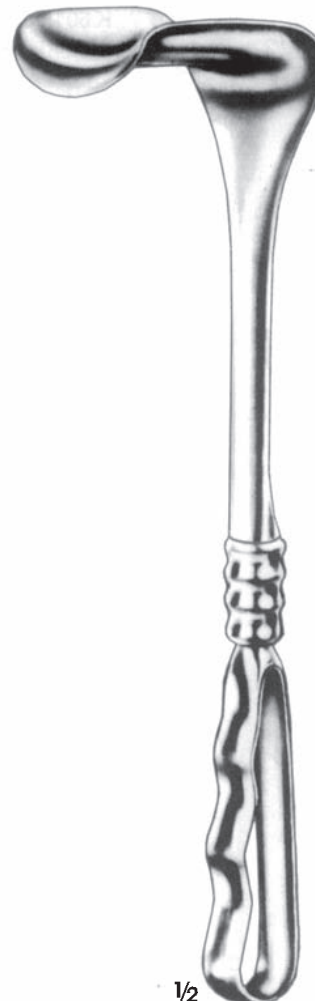

1/2

KELLY
BT 492.00-BT 492.05
26 cm



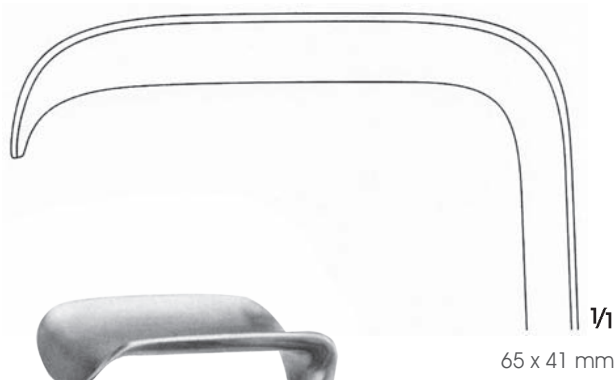

RICHARDSON
BT 493.00
25 cm

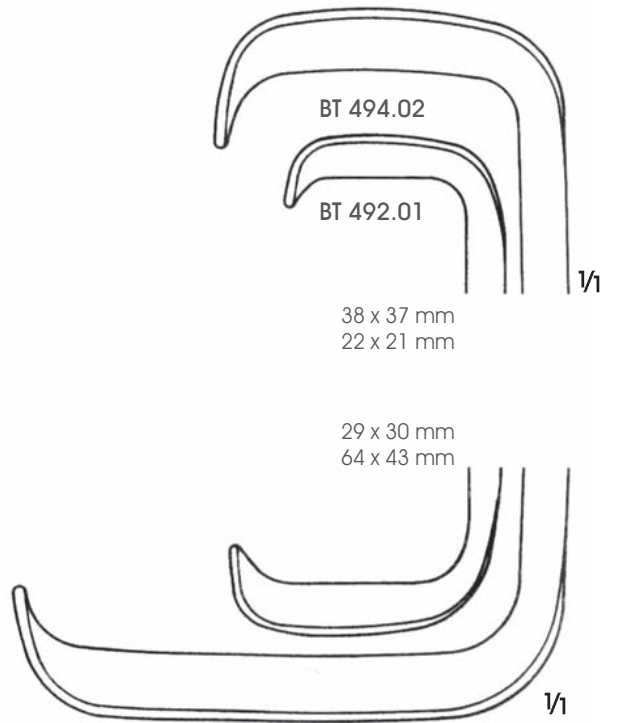

RICHARDSON-EASTMAN
BT 494.00
Komple/Complete
BT 494.01 25 cm
BT 494.02 27 cm

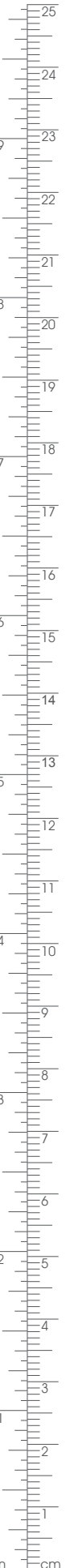
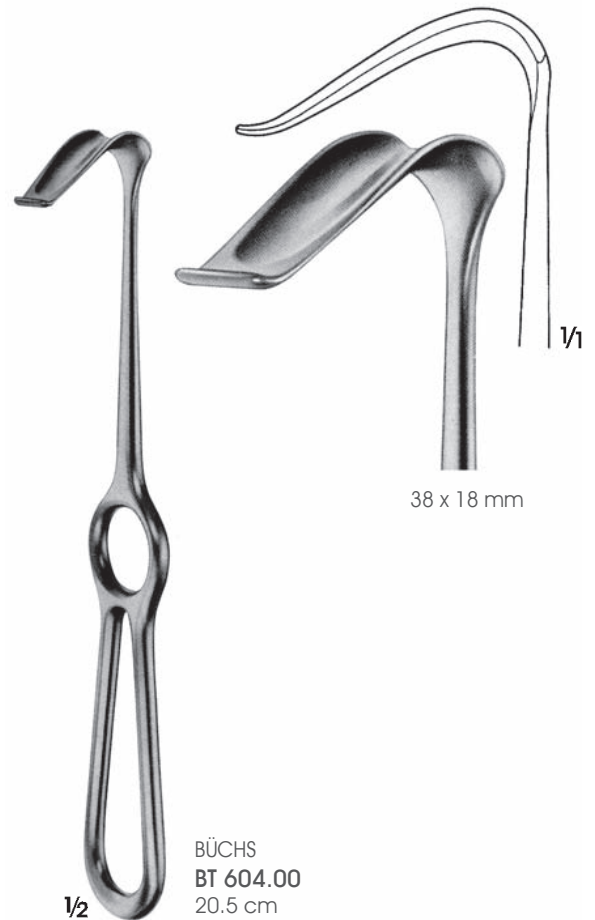
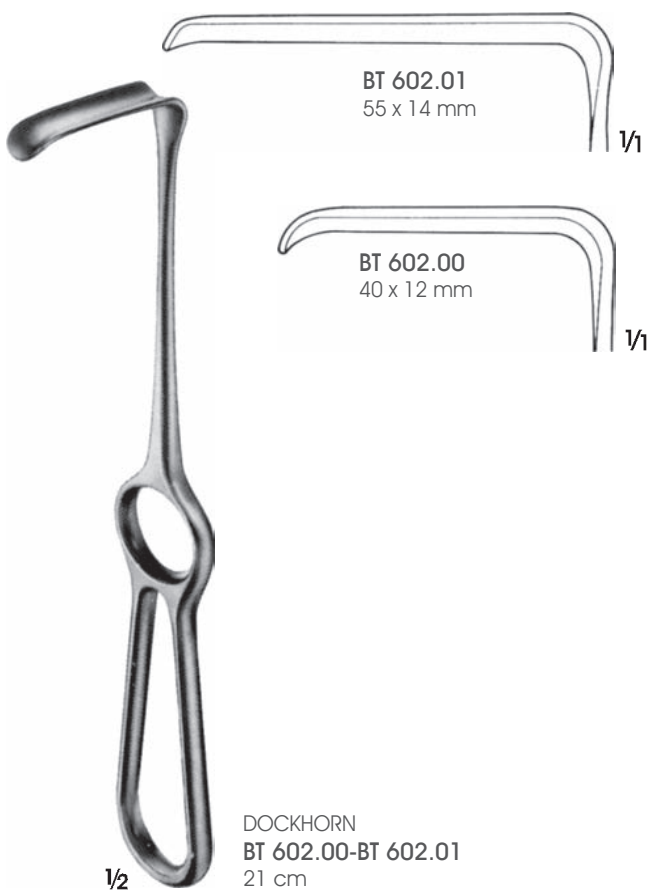

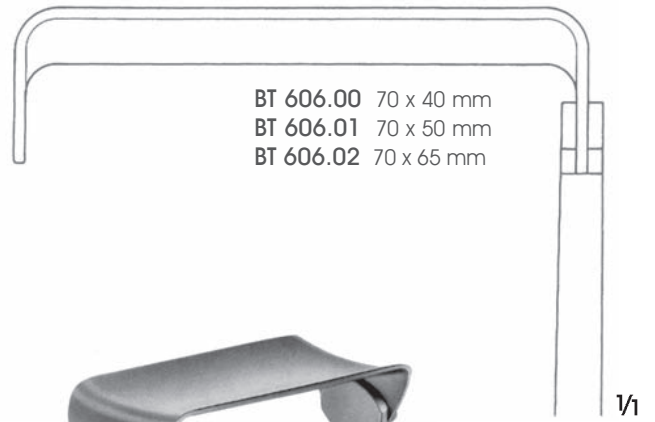
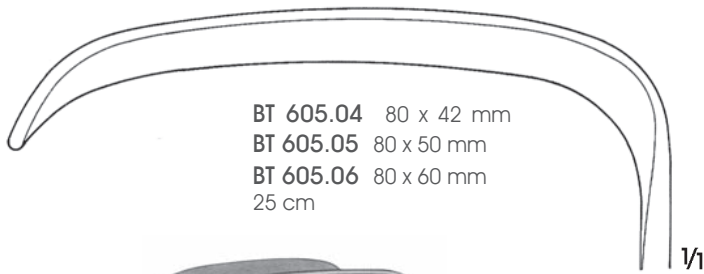
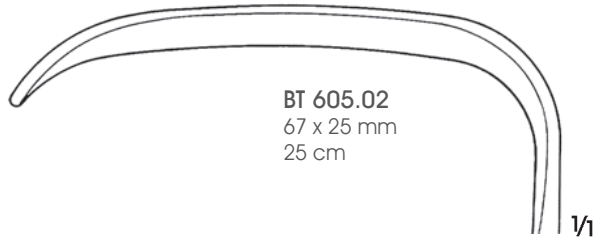



MEYERDING
BT 607.00-BT 607.02



BT 608.03
94 x 36 mm

BT 608.02
64 x 25 mm

BT 608.01
36 x 20 mm

BT 608.00
20 x 15 mm

KOCHER-WAGNER
BT 608.00-BT 608.03
28 cm

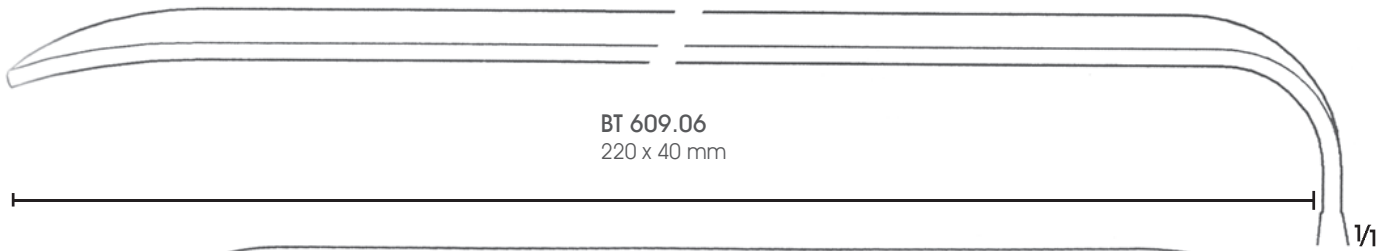

BT 609.06
220 x 40 mm

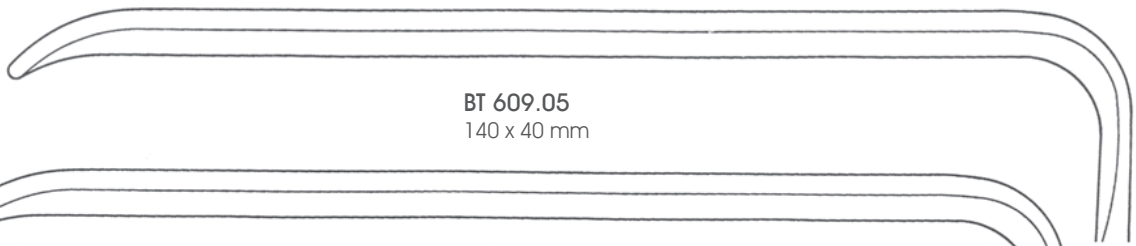

BT 609.05
140 x 40 mm

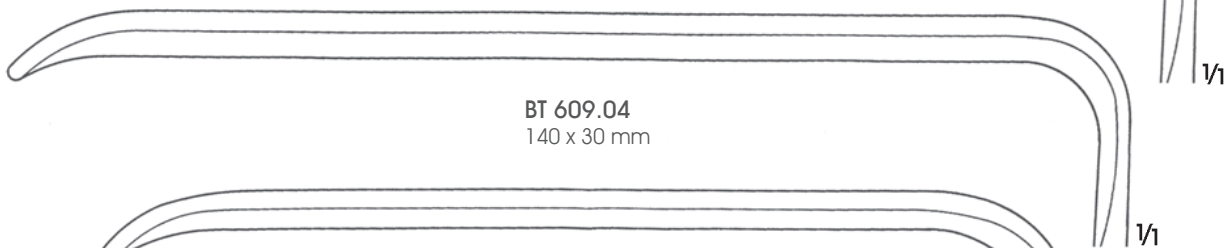

BT 609.04
140 x 30 mm

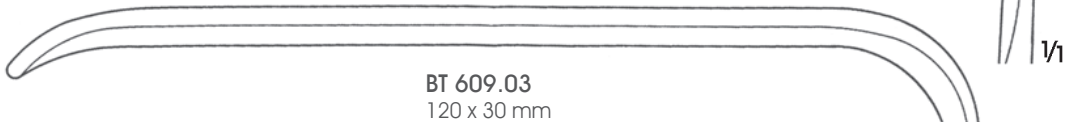

BT 609.03
120 x 30 mm

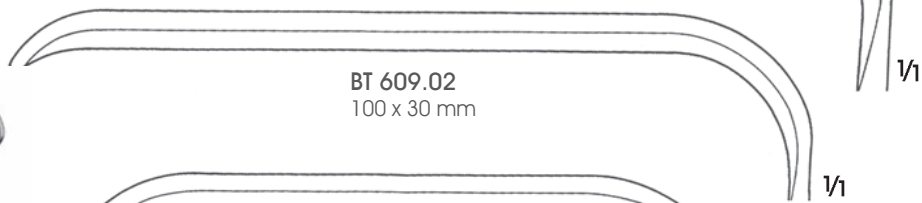

BT 609.02
100 x 30 mm

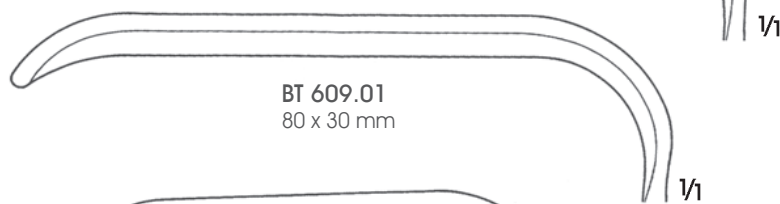

BT 609.01
80 x 30 mm

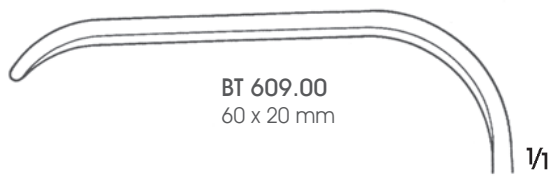

BT 609.00
60 x 20 mm



HOSEL
BT 609.00-BT 609.05
25 cm

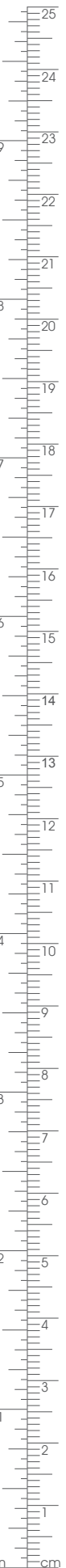





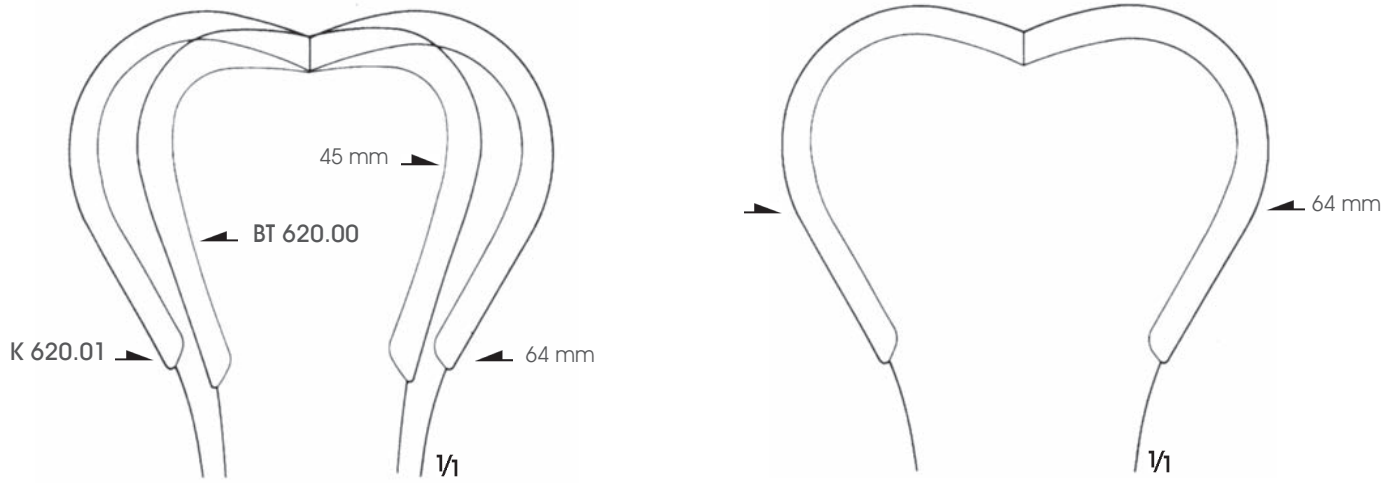

1/2

HARRINGTON
BT 620.00 123 x 45 mm
BT 620.01 123 x 64 mm
Esnek/Flexible
29.5 cm



1/2

HARRINGTON-PEMBERTON
BT 621.00 175 x 64 mm
Esnek/Flexible
29.5 cm



$\frac{1}{2}$
ALLISON
BT 625.02
25.5 cm



$\frac{1}{2}$
ALLISON
BT 625.05
32 cm

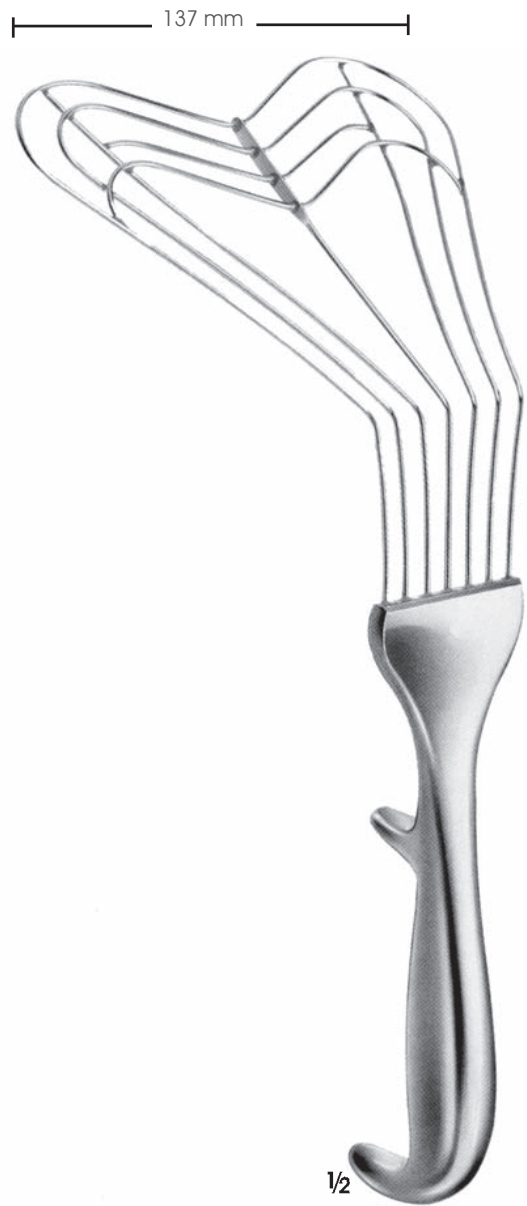

$\frac{1}{2}$
ALLISON
BT 628.02
30 cm

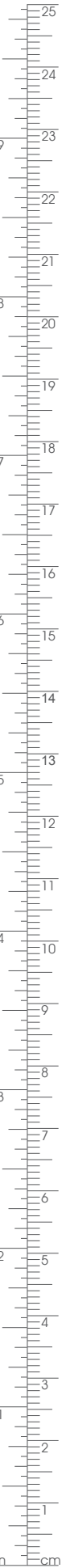

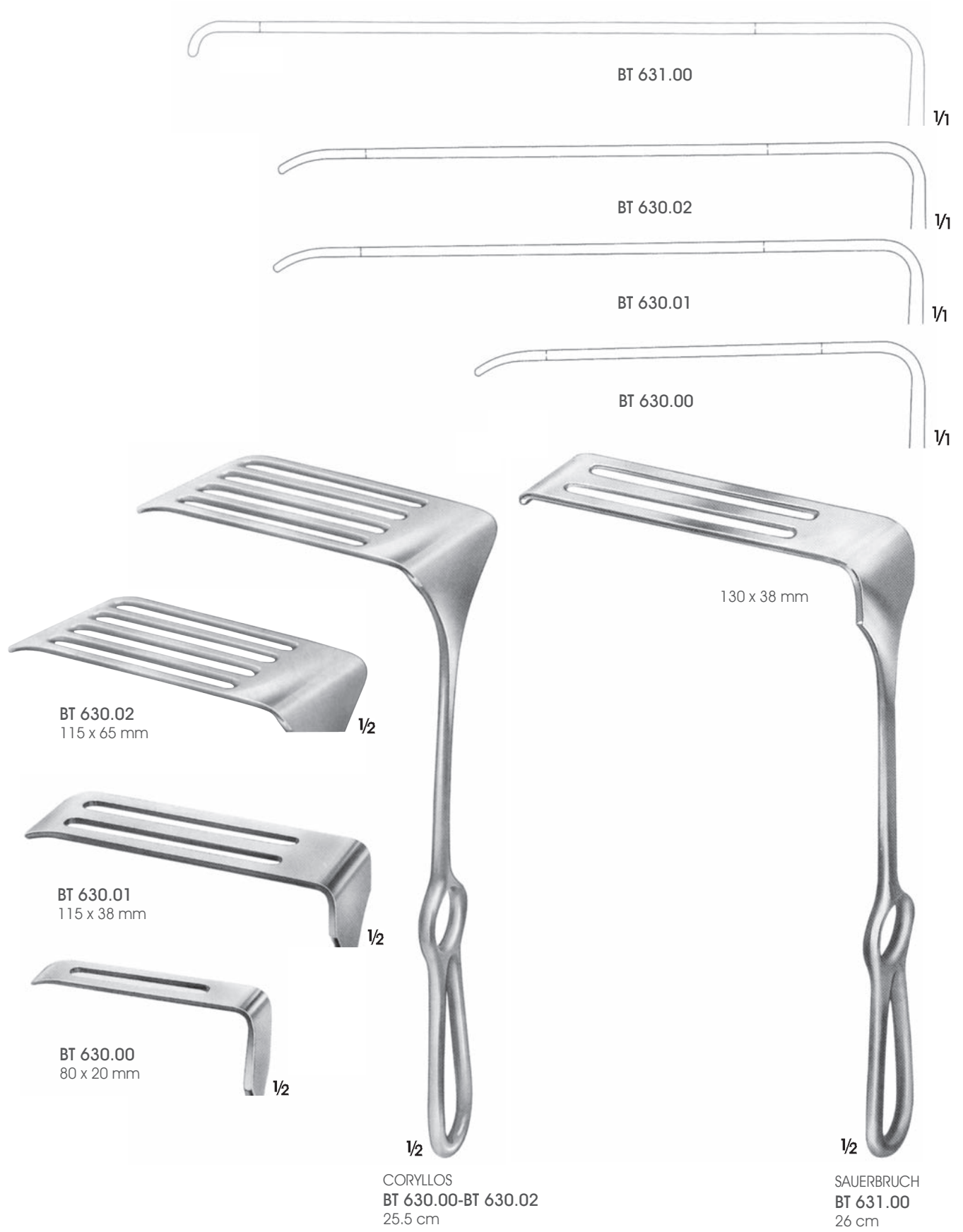

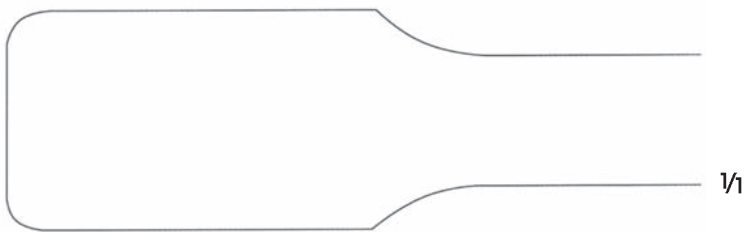

1/2

BT 635.02
26 cm



1/2

BRUNNER
BT 640.00
24 cm

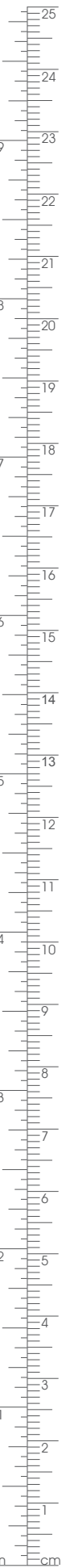



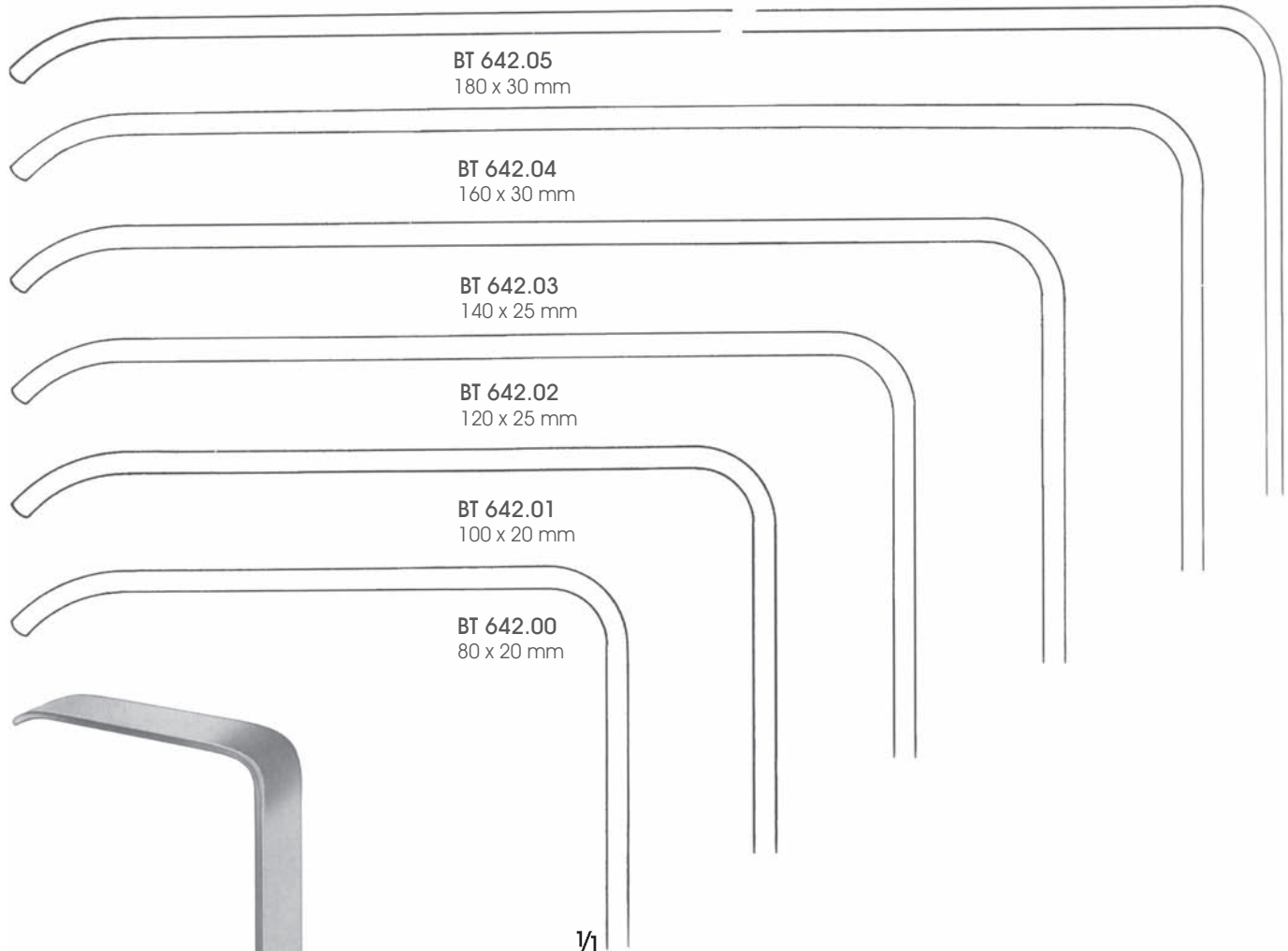

BRUNNER
BT 642.00-BT 642.05
25 cm

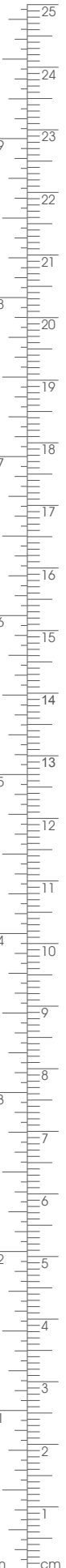



BT 644.06
180 x 30 mm

BT 644.05
160 x 30 mm

BT 644.04
140 x 30 mm

BT 644.03
130 x 30 mm

BT 644.02
120 x 25 mm

BT 644.01
100 x 25 mm

BT 644.00
80 x 20 mm



1/2

BRUNNER
BT 644.00-BT 644.06
27.5 cm



HASSON
MD 661.00-MD 661.01

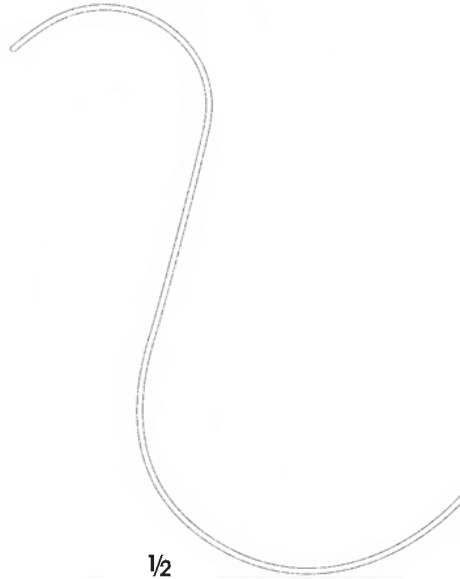

1/2
MD 661.00
10 x 160 mm

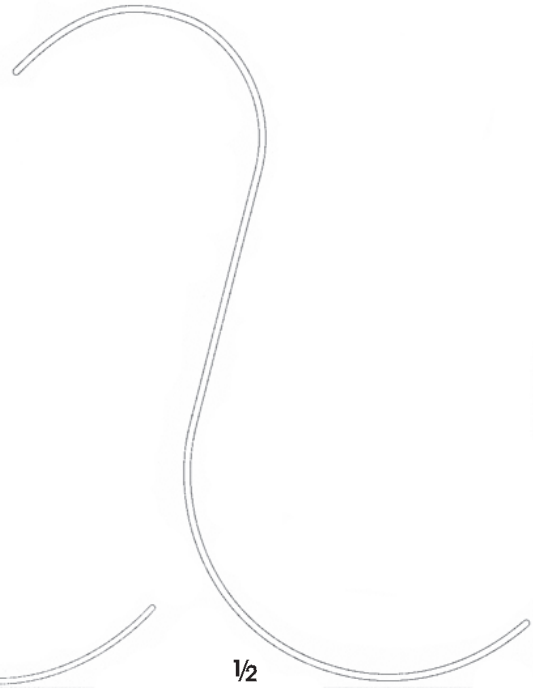

1/2
MD 661.01
13 x 180 mm



1/2
DEAVER
BT 660.01
18 cm



1/2
DEAVER
BT 660.02
21.5 cm



1/2
DEAVER
BT 660.03
23.5 cm

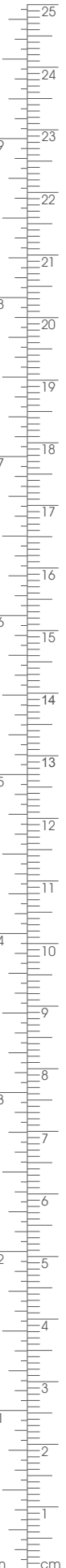



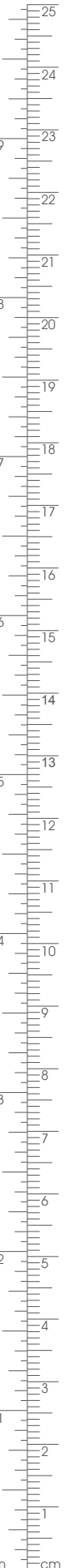





DEAVER
BT 668.04
31 cm



DEAVER
BT 668.05
31 cm

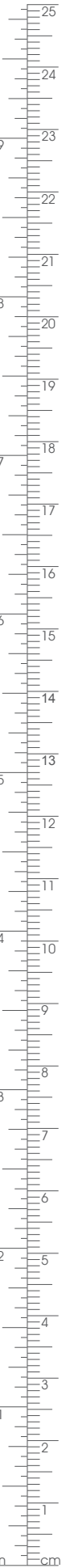



DEAVER
BT 668.07
30.5 cm



DEAVER
BT 668.08
31 cm

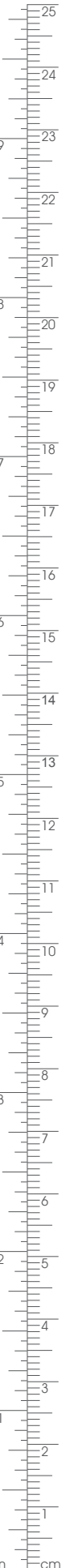

LERICHE
BT 670.00
25.5 cm



LERICHE
BT 670.02
27.5 cm

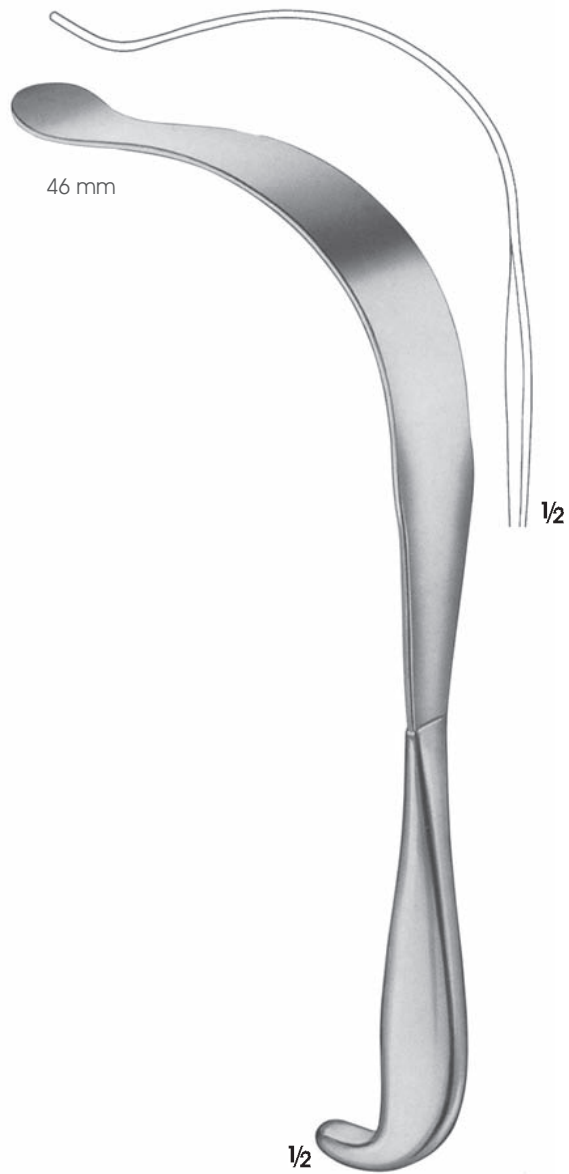

KÜMMEL
BT 672.00
Bükülebilir/Malleable
28.5 cm



KÖRTE
BT 678.02
30 cm



1/2

BT 726.00
Prostat ekartör
Prostate retractor
36 cm



1/2

BT 727.00
Üretral ekartör
Urethral retractor
39 cm



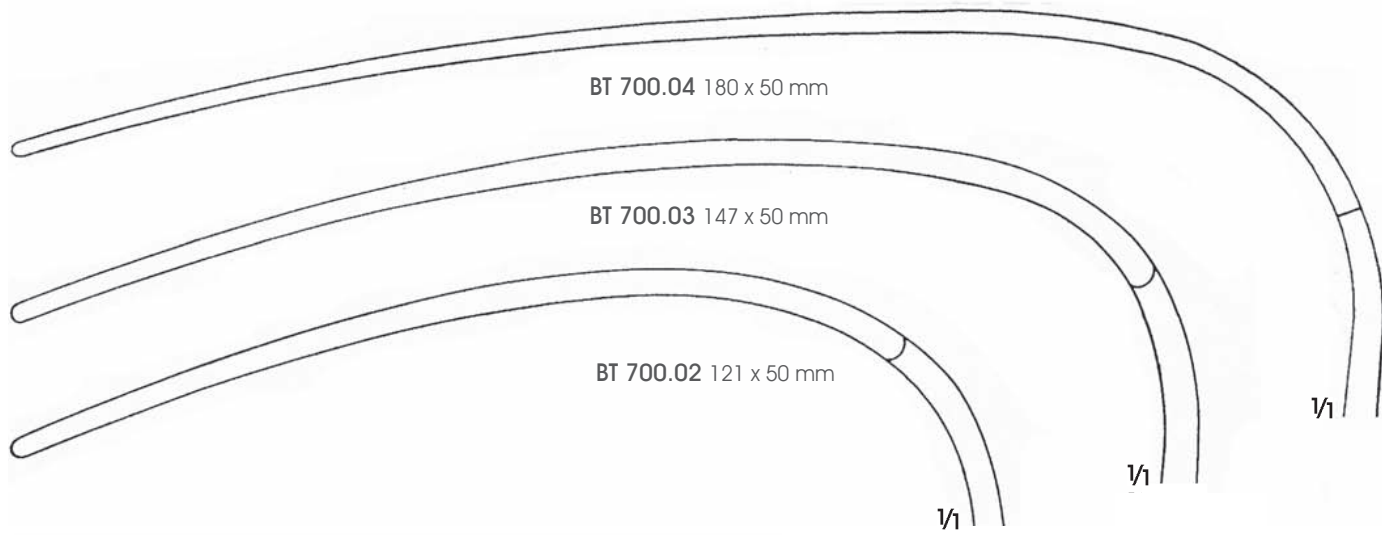

$\frac{1}{2}$
MIKULICZ
BT 700.01
24 cm



$\frac{1}{2}$
MIKULICZ
BT 700.02-BT
700.03 25 cm
BT 700.04
26 cm

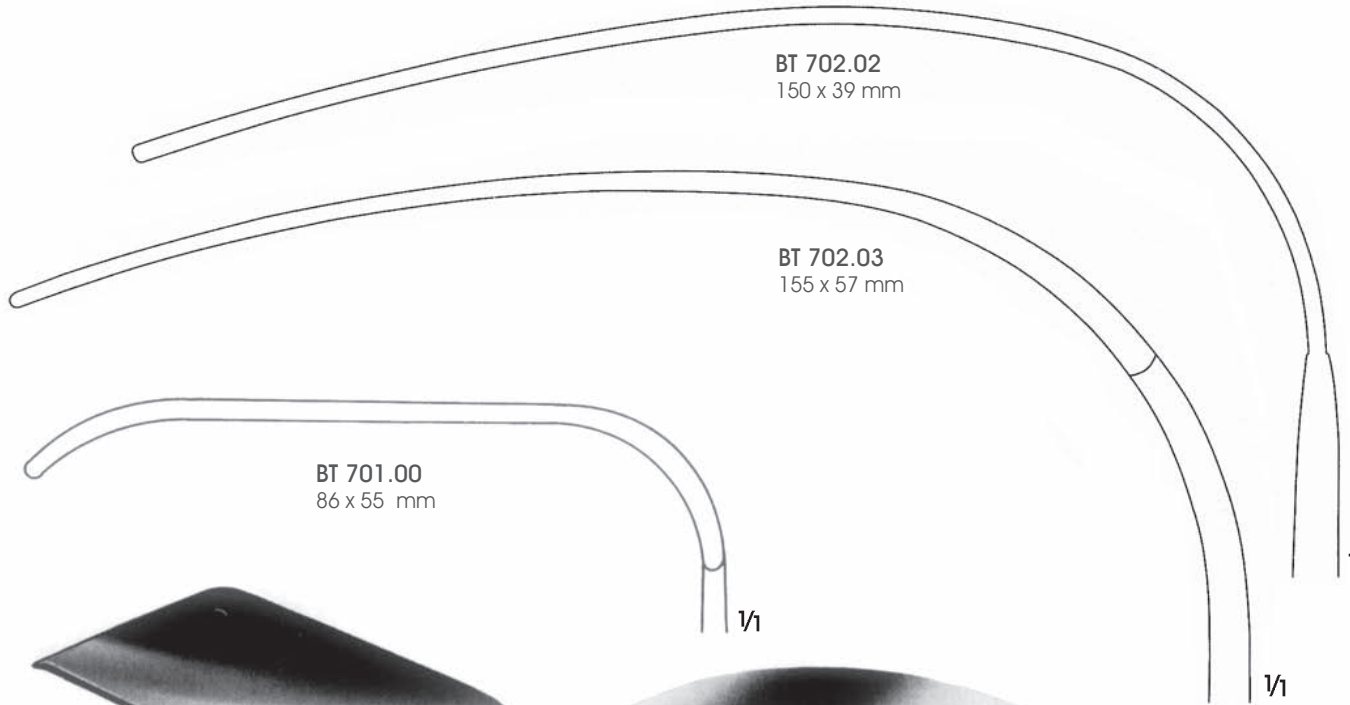

1/2
MIKULICZ
BT 701.00
25.5 cm



1/2
KELLY
BT 702.02-BT 702.03
26 cm

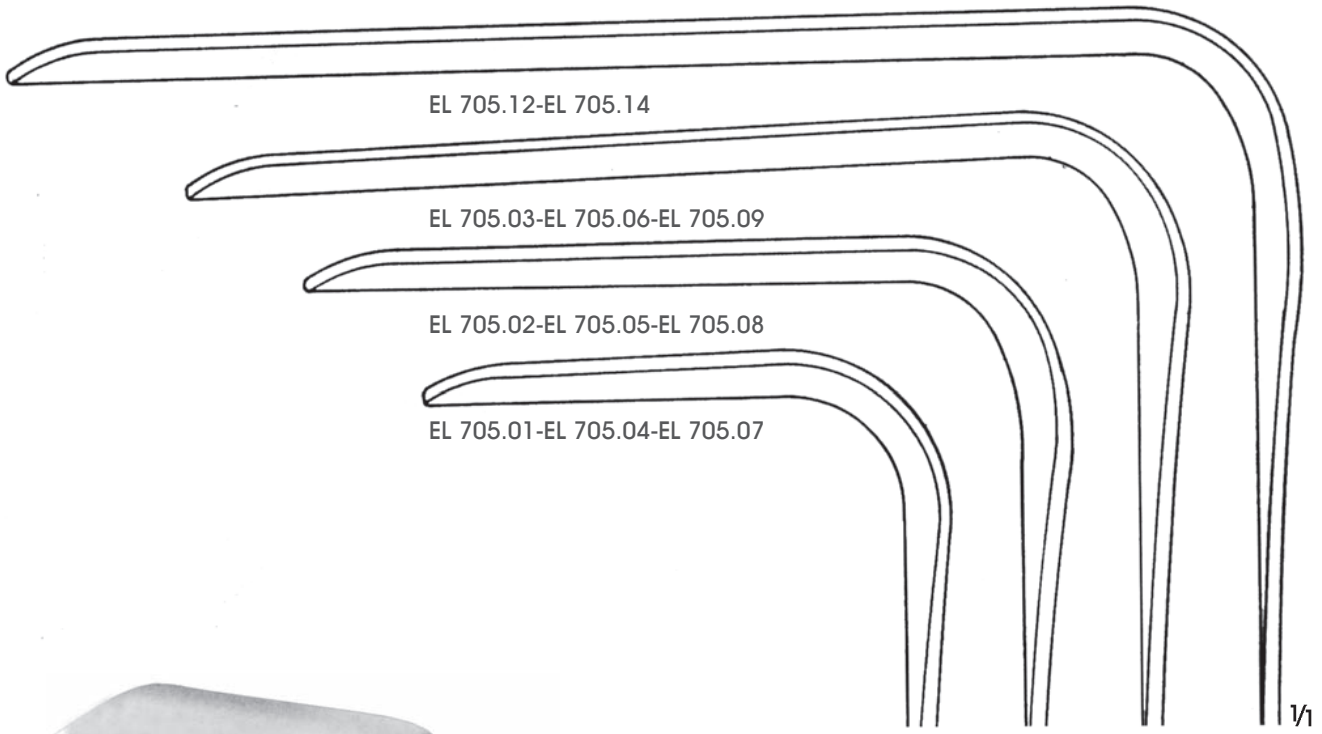

DOYEN
EL 705.01-EL 705.14
24 cm

Ağız uzunlukları
Length of blades

Ağız genişlikleri
Width of blades

	35 mm	45 mm	60 mm
60 mm	EL 705.01	EL 705.04	EL 705.07
90 mm	EL 705.02	EL 705.05	EL 705.08
120 mm	EL 705.03	EL 705.06	EL 705.09
160 mm		EL 705.12	EL 705.14



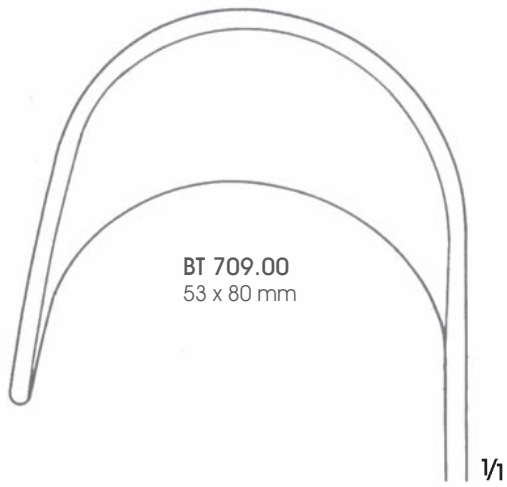

BT 709.00
53 x 80 mm



BT 710.00
78 x 82 mm



DOYEN
BT 709.00
25 cm



DOYEN
BT 710.00
26 cm

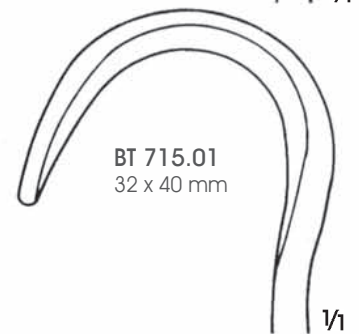
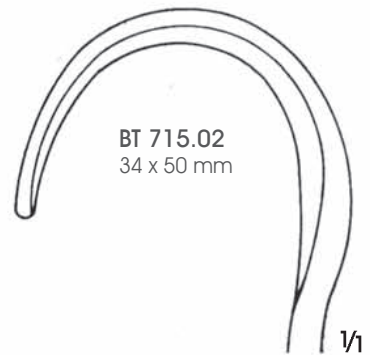
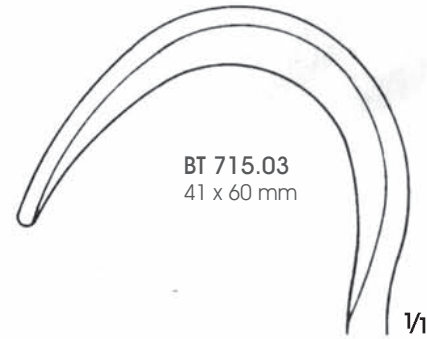
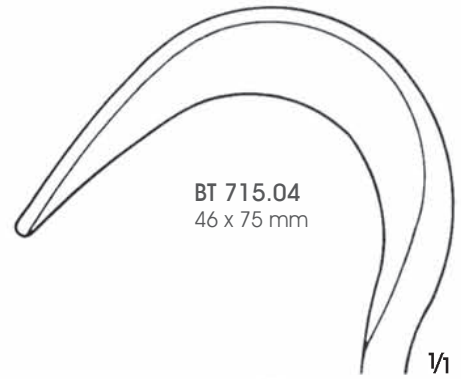
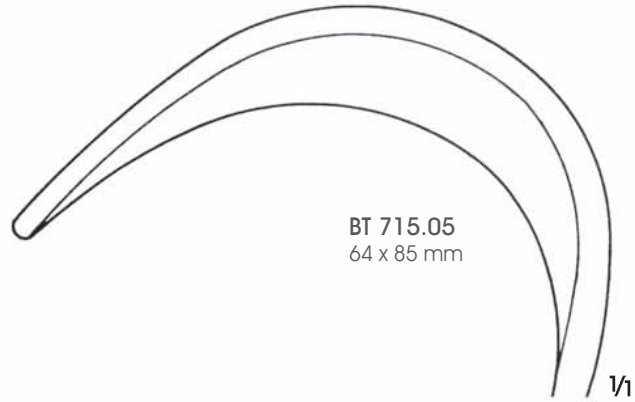

FRITSCH
BT 715.01-BT 715.05
24 cm



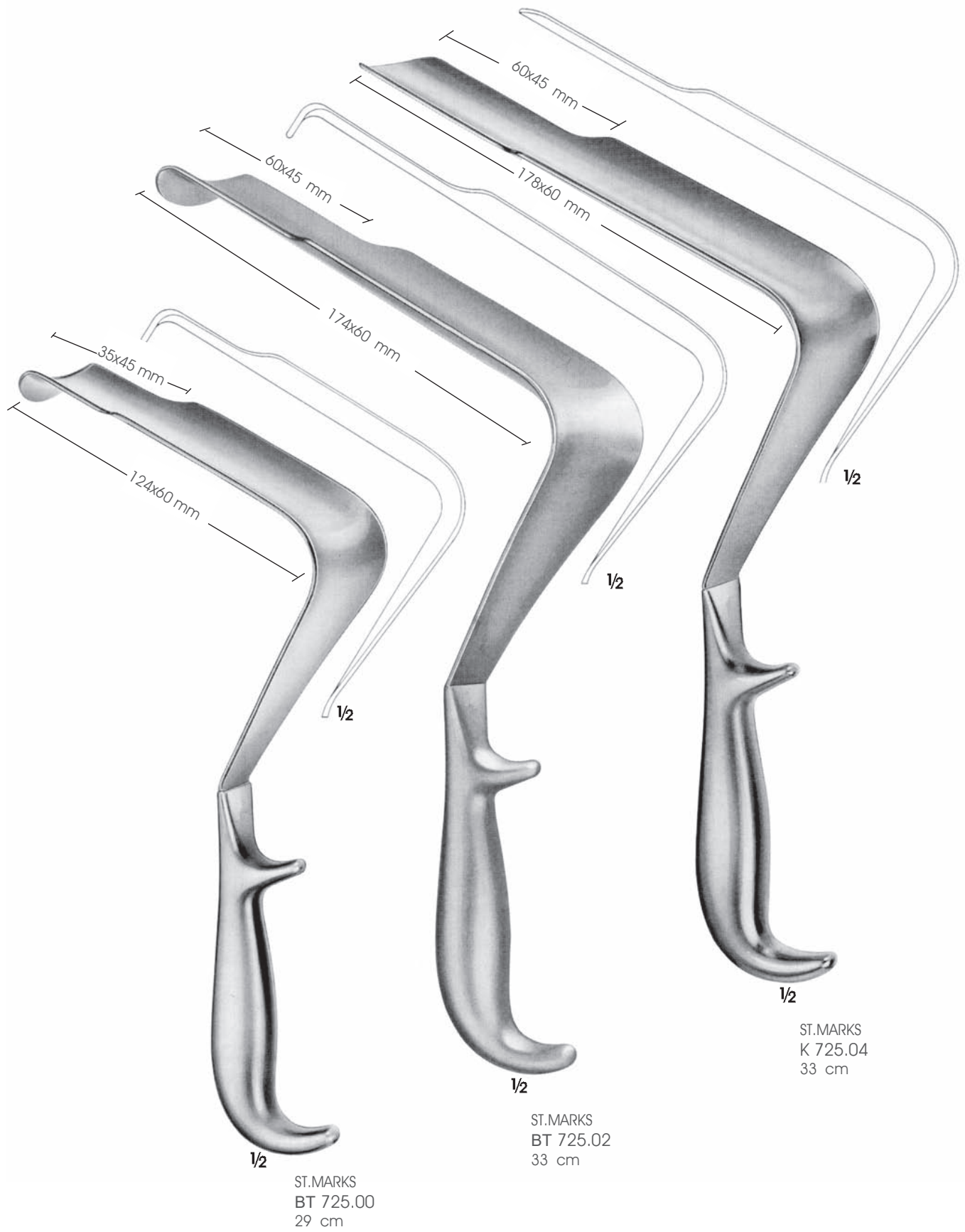



250 x 30 mm

200 x 30 mm

1/2

MÜLLER
BT 726.02
27 cm

1/2

MÜLLER
BT 726.01
27 cm

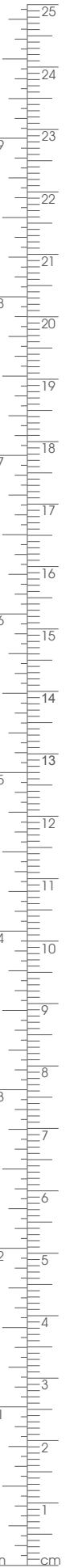

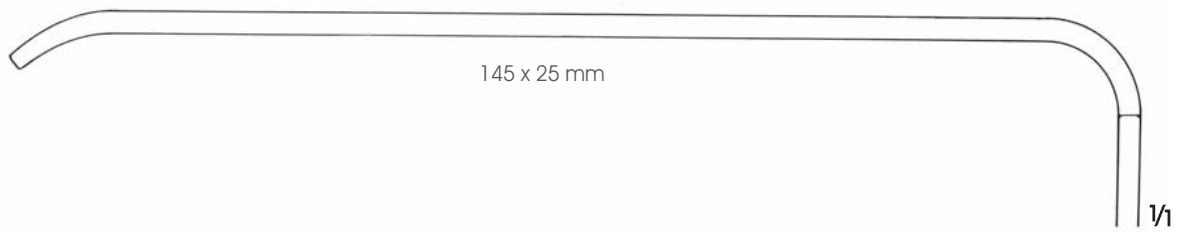

1/2

BRUNNER
BT 728.00
24 cm



1/2

BRUNNER
BT 728.02
Işık taşıyıcılı/With light carrier
24 cm



MIKULICZ
BT 730.00 120 x 50 mm
BT 730.01 150 x 50 mm
Işık taşıyıcılı/With light carrier
26 cm



53 x 85 mm

DOYEN
BT 731.00
25 cm



DOYEN
BT 731.10
Işık taşıyıcılı/With light carrier
25 cm

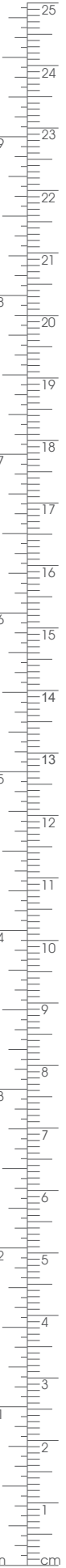



1/3

DOYEN
BT 732.00 48 x 90 mm
BT 732.01 48 x 105 mm
BT 732.02 48 x 120 mm
BT 732.03 48 x 135 mm
28 cm



1/3

ROCHARD
BT 739.00 48 x 90 mm
BT 739.01 48 x 105 mm
BT 739.02 48 x 120 mm
BT 739.03 48 x 135 mm
BT 739.04 48 x 155 mm
31 cm



1/3

BT 790.01 Komple /Complete
(K 736.00) Zincir/With chain
(T 790.00/645 gr.)Ağırlık/Weight
79 cm



1/3

ROCHARD
BT 737.00-BT 739.00

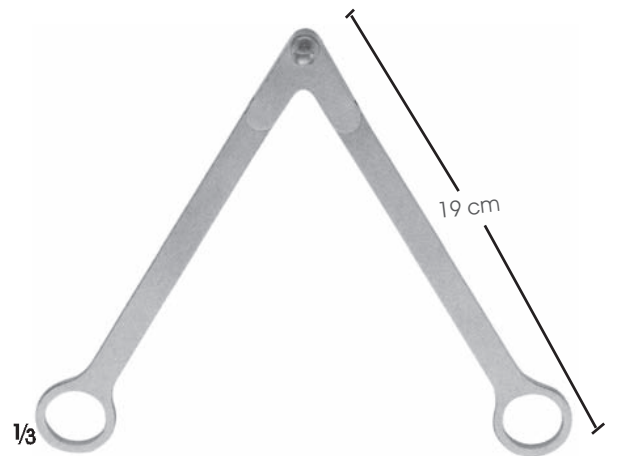

1/3

ROCHARD
BT 737.00
Bağlantı tertibatı K 739.00-K 739.04
Fixation device for K 739.00-K 739.04

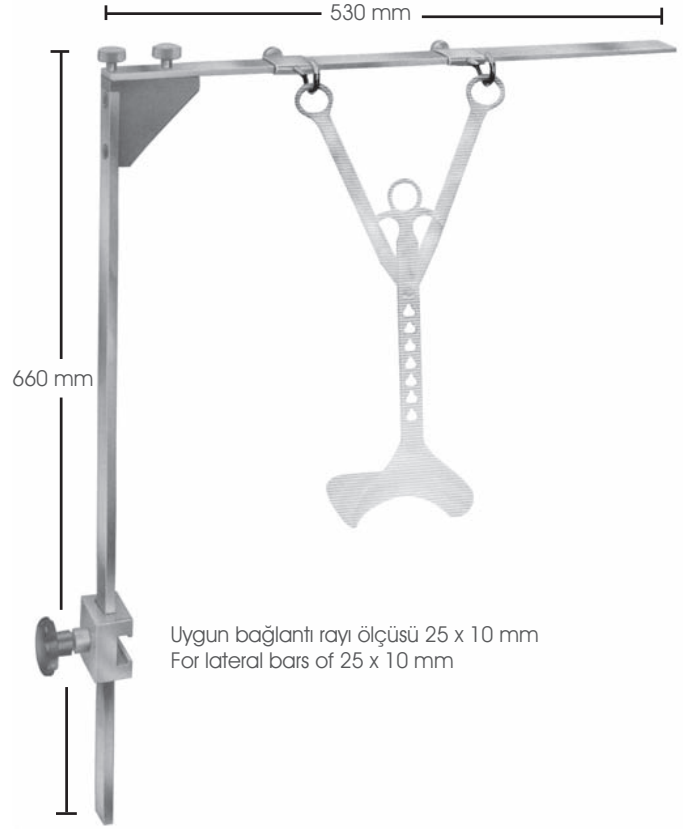

ROCHARD
BT 740.00

Daha sağlam bağlantı oluşturmak üzere ameliyat masalarının her iki yan bağlantı rayına bağlanan montaj çerçevesi, sterilasyon için sökülebilir.
Mounting frame for fastening to both sides of the lateral bars of the operating tables, thus more stability is given, can be dismantled for sterilization.

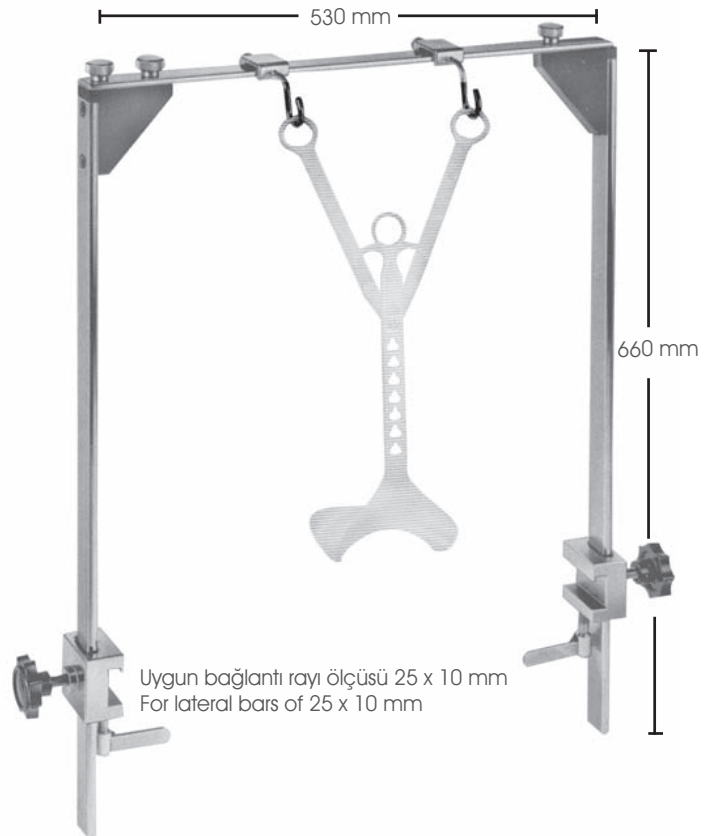

ROCHARD
BT 742.00

Daha sağlam bağlantı oluşturmak üzere ameliyat masalarının her iki yan bağlantı rayına bağlanan montaj çerçevesi, sterilasyon için sökülebilir.
Mounting frame for fastening to both sides of the lateral bars of the operating tables, thus more stability is given, can be dismantled for sterilization.





BT 752.00 200 x 12 mm
BT 752.01 200 x 17 mm
BT 752.02 250 x 25 mm
Bükülebilir/Malleable

TUFFIER
BT 754.00
Bükülebilir
Malleable
20 cm

KADER
BT 676.02 30 mm
BT 676.04 40 mm
mm 27 cm

BT 758.00 30 mm
BT 758.01 40 mm
BT 758.02 50 mm
BT 758.03 60 mm
BT 758.04 70 mm
Bükülebilir/Malleable
41 cm

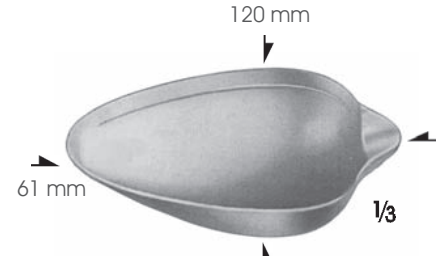

BT 886.00
Kan kaşığı/Blood scoop
Hacmi 50 cc/Volume 50 cc



HABERER
BT 760.00
Bükülebilir/Malleable
30.5 cm



RIBBON
BT 756.04 25 mm
BT 756.00 30 mm
BT 756.01 40 mm
BT 756.02 50 mm
Bükülebilir/Malleable
33 cm



REVERDIN
BT 764.00
28.5 cm



KOCHER
BT 766.00
Kaşık şeklinde bastırıcı
Depressor, spoon shaped
22 cm

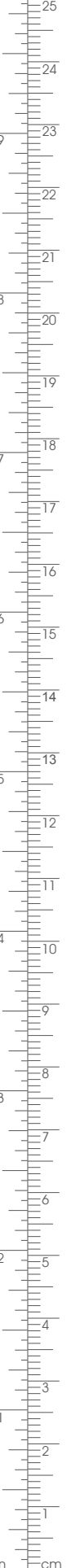

BV Otomatik Ekartörler
Self-Retaining Retractors



 **ARGENT**

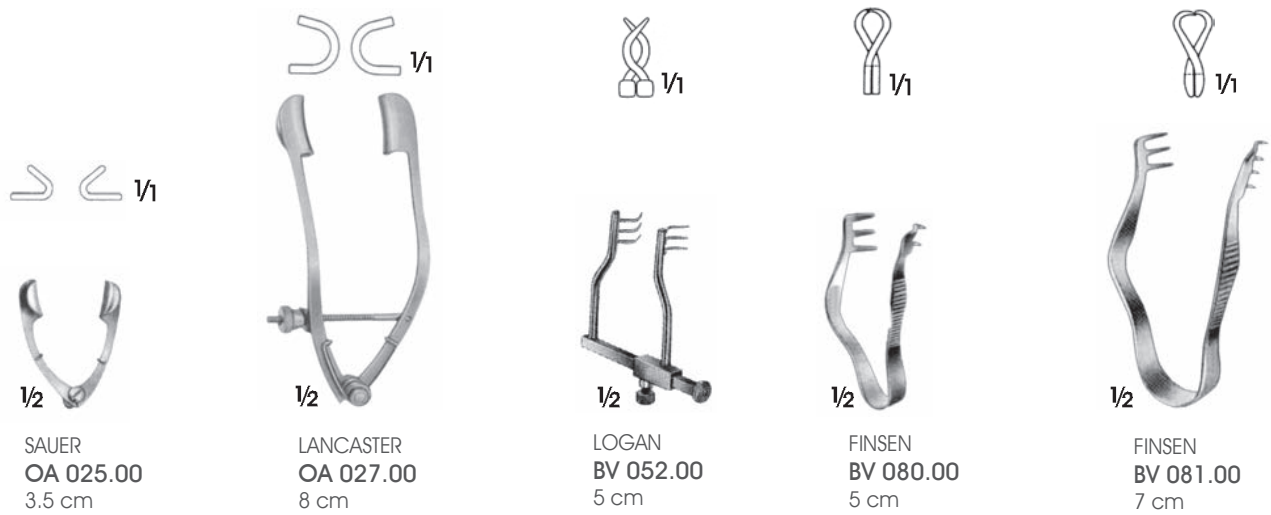
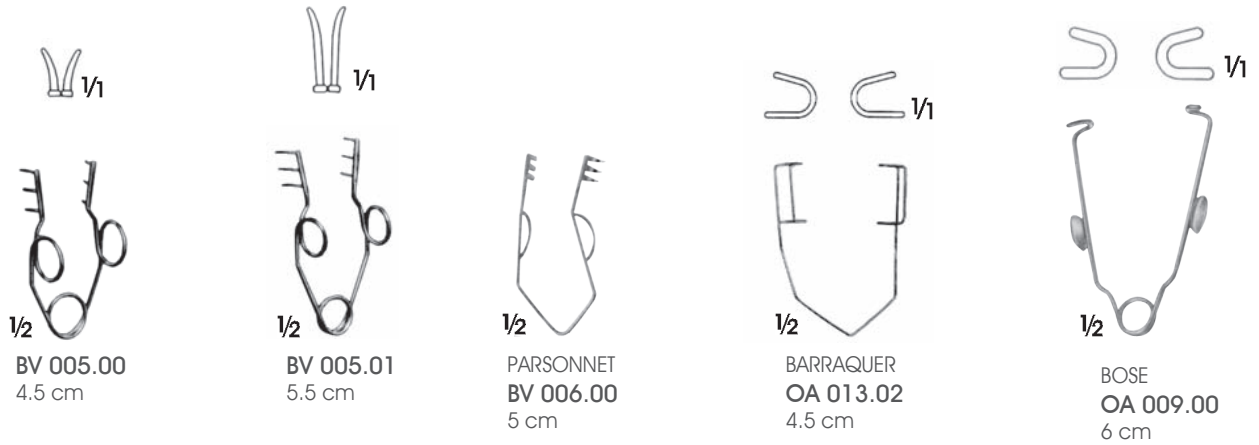



FINSEN
BV 082.00
7.5 cm



FINSEN
BV 083.00
7 cm



BV 085.00
Künt/Blunt 10 cm



BV 085.01
Sivri/Sharp
10 cm



ALM
BV 088.00 7 cm
BV 088.01 10 cm



BV 437.00
Otomatik ekartör
Self-retaining retractor
12 cm



ALLPORT
BV 089.00
9.5 cm



JANSEN
BV 093.00 Sivri/
Sharp 10 cm



JANSEN
BV 095.00
10 cm



JANSEN
BV 097.00
10 cm



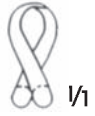

1/2

WEITLANER
BV 300.00 Sivri/Sharp
11 cm



1/2

WEITLANER
BV 301.00 Künt/Blunt
11 cm

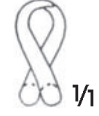

1/2

WEITLANER
BV 302.00 Yarı Sivri/Semi-sharp
11 cm

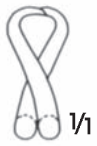

1/2

WEITLANER
BV 304.00 Sivri/Sharp
13 cm



1/2

WEITLANER
BV 305.00 Künt/Blunt
13 cm

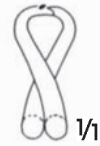

1/2

WEITLANER
BV 306.00 Yarı sivri/Semi-sharp
13 cm



WEITLANER
BV 308.00 Sivrî/Sharp
13 cm



WEITLANER
BV 309.00 Künt/Blunt
13 cm



WEITLANER
BV 312.00 Sivrî/Sharp
16.5 cm



WEITLANER
BV 313.00 Künt/Blunt
16.5 cm



WEITLANER
BV 314.00 Yarı sivrî/Semi-sharp
16.5 cm

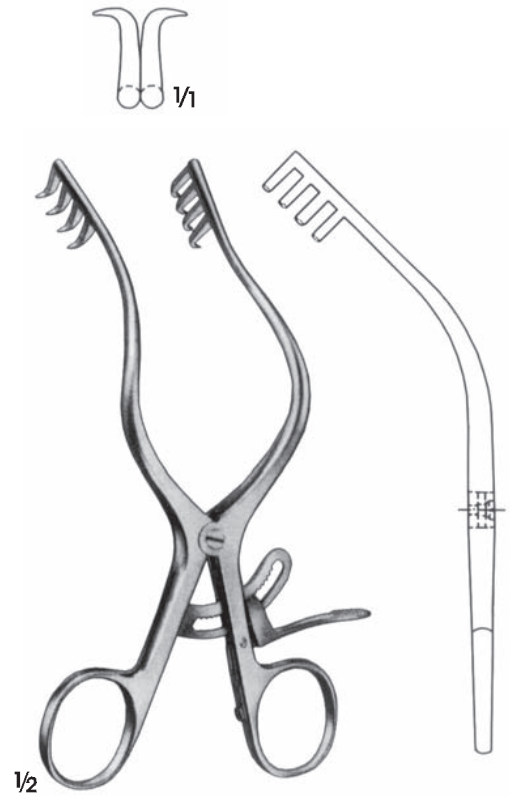

MOLLISON
BV 318.00 Sivrî/Sharp
15.5 cm

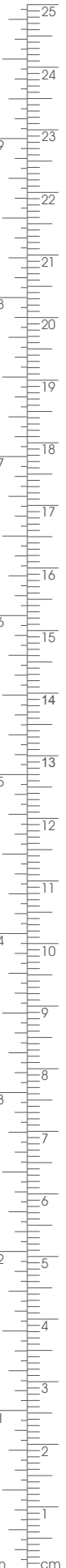

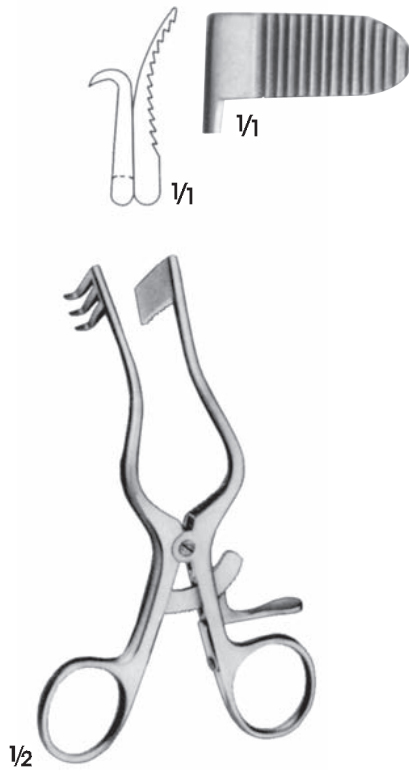

PERKINS
OK 320.00
13 cm



PERKINS
OK 321.00
13 cm

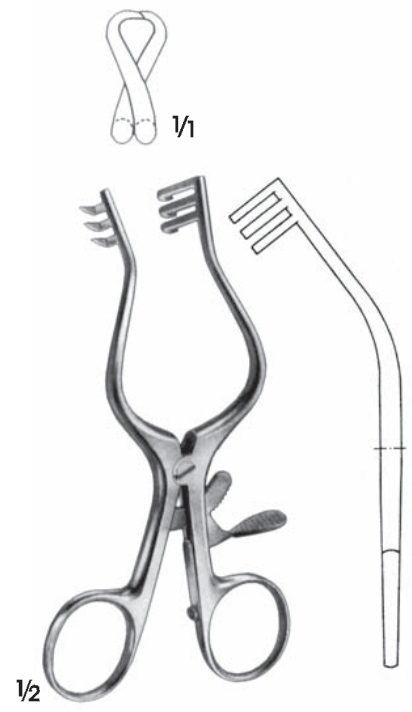

WULLSTEIN
BV 325.00 Sivri/Sharp
13 cm

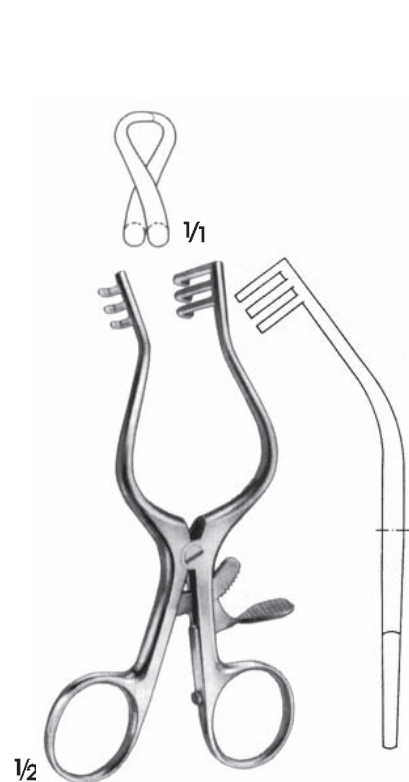

WULLSTEIN
BV 326.00 Künt/Blunt
13 cm

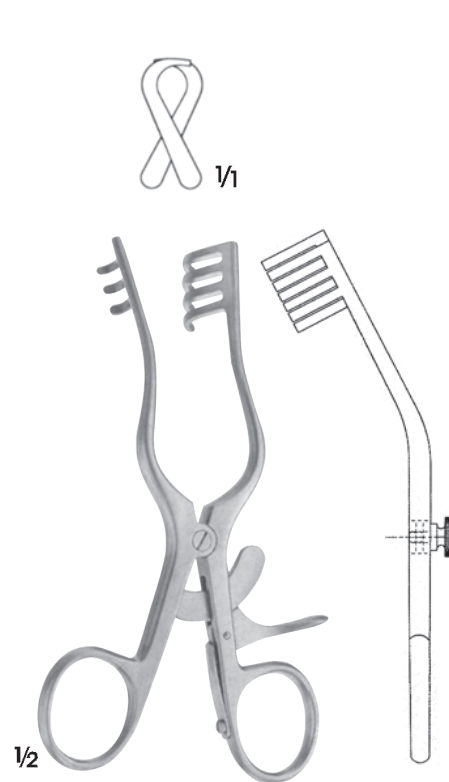

JEFFERSON
BV 327.00 Künt/Blunt
Eğri/Curved
14 cm



RNTNE
BV 328.00 Sivri/Sharp
16.5 cm



HENDERSON
BV 329.00 Sivri/Sharp
18 cm



ADSON-BABY
BV 330.02 14 cm
BV 331.02 16 cm
Yarı sivri/Semi sharp



ADSON
BV 330.04 Sivri/Sharp
BV 331.04 Künt/Blunt
16 cm



ADSON
BV 330.06 Sivri/Sharp
BV 331.06 Künt/Blunt
20 cm



PLESTER
BV 335.00 Künt/Blunt
Sol/Left
11 cm



PLESTER
BV 336.00 Künt/Blunt
Sağ/Right
11 cm

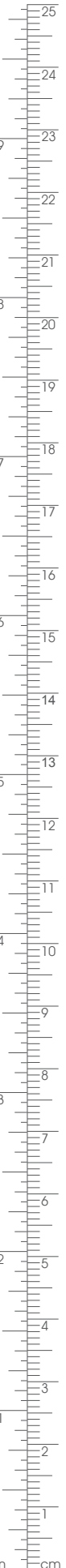

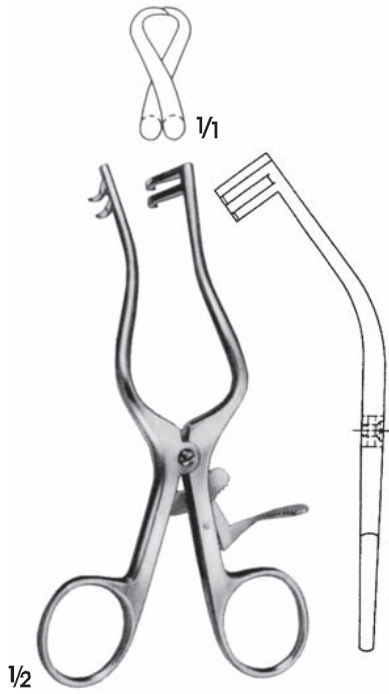

PLESTER
BV 338.00 Sivri/Sharp
13 cm

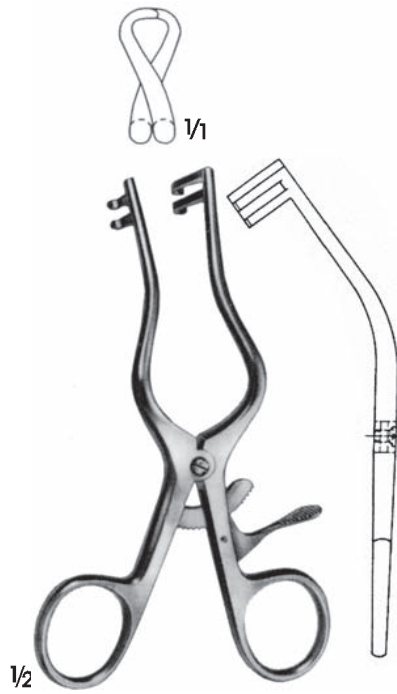

PLESTER
BV 339.00 Künt/Blunt
13 cm



MOLLISON
BV 340.00 Sivri/Sharp
14 cm



TÜBINGER
BV 345.00
16.5 cm



IRWIN
BV 347.00 Sivri/Sharp
17.5 cm

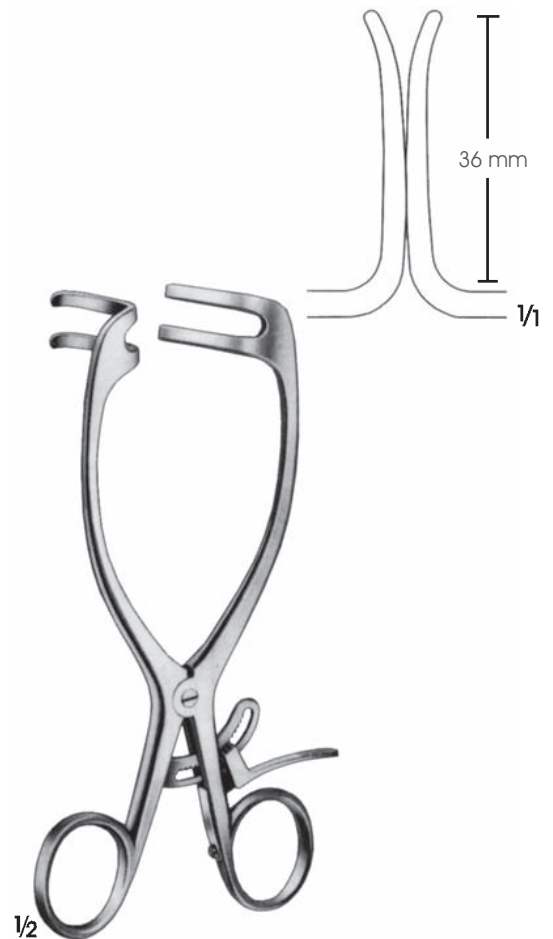

MAYO-ADAMS
BV 348.00
16.5 cm



WEITLANER
BV 350.00 Sivri/Sharp
BV 351.00 Künt/Blunt
18 cm



BV 402.03
Sadece ekartör/Retractor only
Künt/Blunt
17 cm

ALLENBERG
BV 402.00 Komple/Complete
BV 402.03 Sadece ekartör,
künt Retractor only, blunt 17 cm
BV 402.05 Bleyd/Blade 12 cm
35 x 10 mm - 20 x 12 mm
Karis ekartör/Carotid retractor
system



TRAVERS
BV 352.00
Künt/Bulunt
Laminektomi ekartör
Laminectomy retractor
21.5 cm

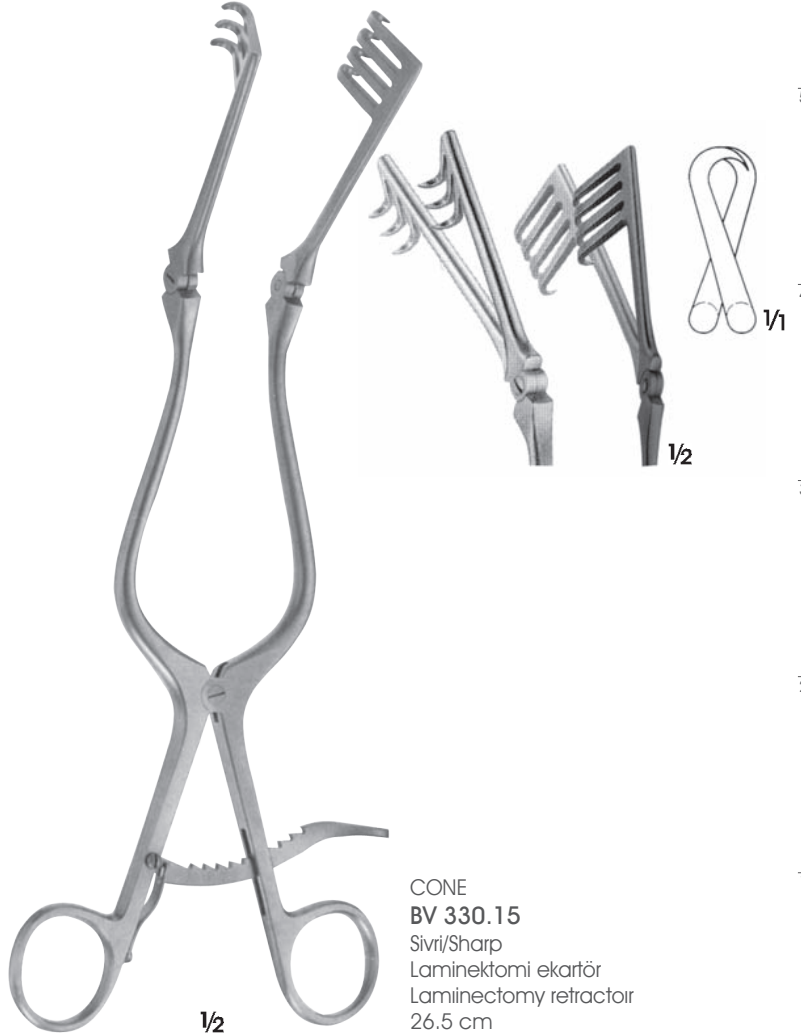

CONE
BV 330.15
Sivri/Sharp
Laminektomi ekartör
Laminectomy retractor
26.5 cm





BV 353.01
Sivri/Sharp
19.5 cm



BV 353.02
Sivri/Sharp
24 cm

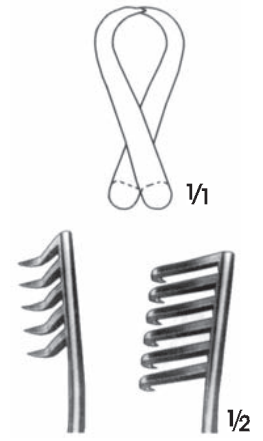

BV 353.03
Sivri/Sharp
25.5 cm



BV 355.01
Yarı sivri
Semi-sharp
19.5 cm

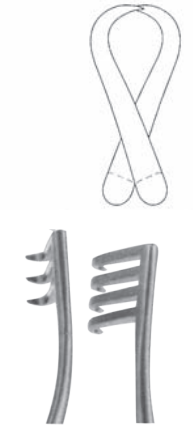

BV 355.02
Yarı sivri
Semi-sharp
24 cm

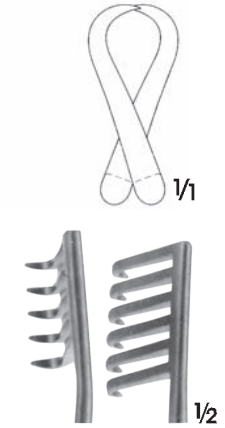

BV 355.03
Yarı sivri
Semi-sharp
25.5 cm



BV 354.01
Künt/Blunt
19.5 cm



BV 354.02
Künt/Blunt
24 cm

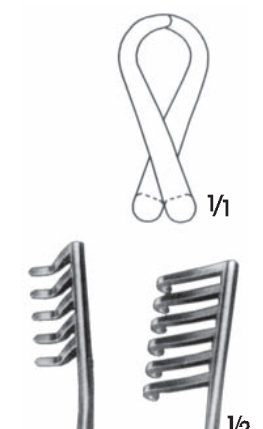

BV 354.03
Künt/Blunt
25.5 cm



WEITLANER
BV 353.01-BV 354.03

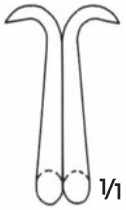

MISKIMON
BV 360.00 Sivri/Sharp
19 cm



NORFOLK-NORWICH
BV 362.00 Künt/Blunt
22 cm



ADSON
BV 364.00 Sivri/Sharp
26.5 cm



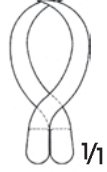
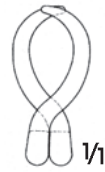
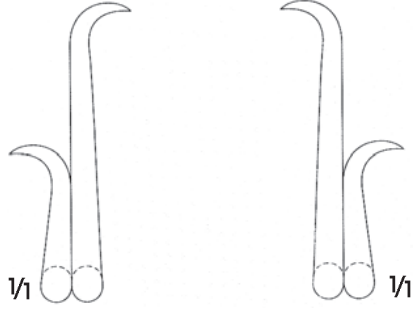

BV 366.02
Hemi Laminektomi ekartör/Sivri
Hemi-laminectomy retractor/Sharp
28 cm



BV 368.02
Sivri/Sharp
28 cm



**BECKMANN-ADSON
BV 370.02**
Sivri/Sharp
31 cm



**BECKMANN-ADSON
BV 371.02**
Yarı sivri/Semi-sharp
31 cm

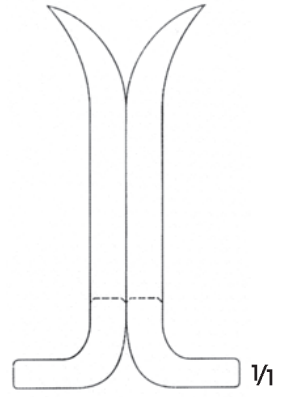
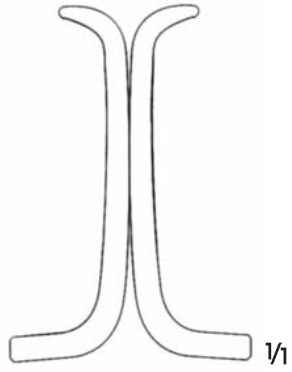

1/2

HARLEY JACKSON
BV 373.02
Sivri/Sharp
28 cm



ADSON
BV 375.02
Yarı Sivri/Semi Sharp
32 cm



BECKMANN-EATON
BV 377.02 Sivri/ Sharp
32 cm





MEYERDING
MF 380.01-MF 381.05
18 cm



MEYERDING
MF 380.00-MF 381.04
18 cm

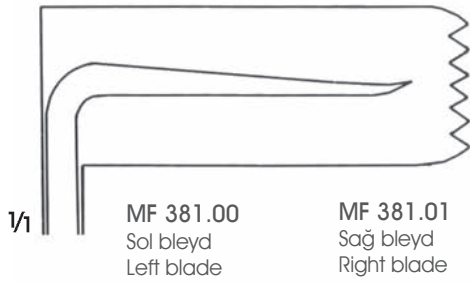

MF 381.00 Sol bleyd
Left blade

MF 381.01 Sağ bleyd
Right blade

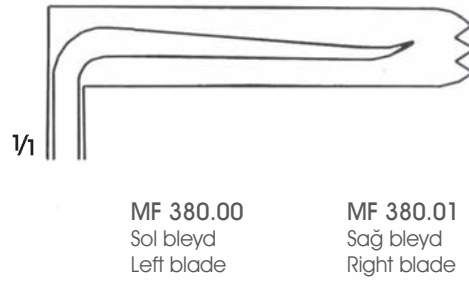

MF 380.00 Sol bleyd
Left blade

MF 380.01 Sağ bleyd
Right blade

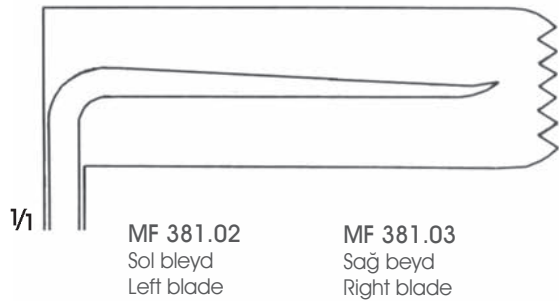

MF 381.02 Sol bleyd
Left blade

MF 381.03 Sağ bleyd
Right blade

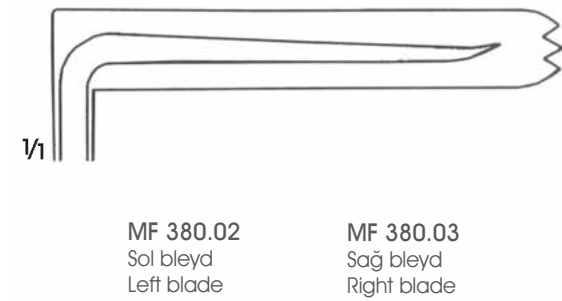

MF 380.02 Sol bleyd
Left blade

MF 380.03 Sağ bleyd
Right blade

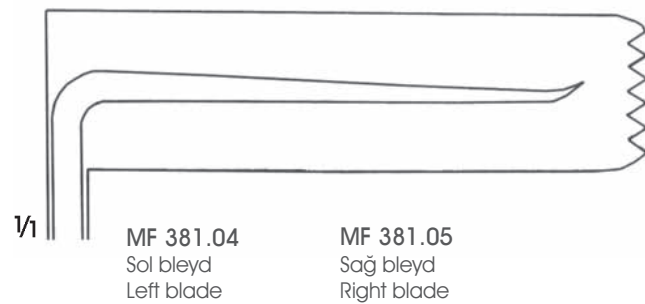

MF 381.04 Sol bleyd
Left blade

MF 381.05 Sağ bleyd
Right blade

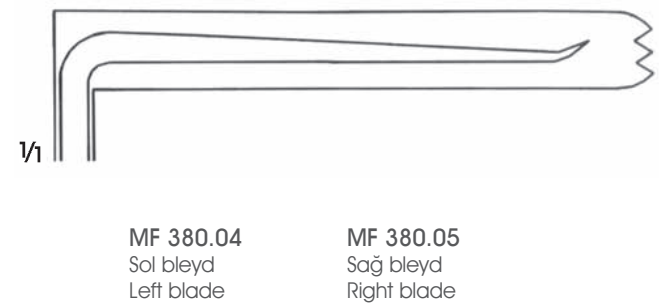

MF 380.04 Sol bleyd
Left blade

MF 380.05 Sağ bleyd
Right blade



DARLING
MF 384.01
18 cm

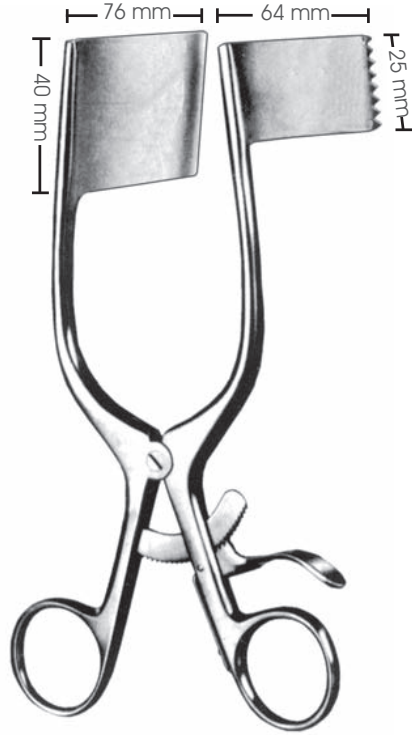

DARLING
MF 384.02
18 cm



MEYERDING
MF 386.00 25 x 40 mm
MF 386.01 25 x 50 mm
MF 386.02 25 x 60 mm
17 cm



MF 390.00
17 cm



MF 392.00 Sağ/Right
18 cm



MF 394.00 Sol/Left
18 cm



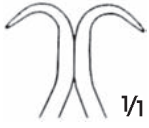

1/2

DE BAKEY
BV 405.00
Kalça kemiği ekartörü, çocuk için
Femur retractor for children
10 cm

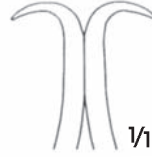

1/2

DE BAKEY
BV 406.00
Kalça kemiği ekartörü
Femur retractor
14.5 cm



1/2

GELPI
BV 408.00
Vajinal ekartör
Vaginal retractor
13.5 cm



1/2

RICHTER
BV 412.00
17 cm

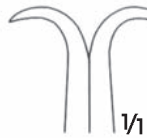

1/2

GELPI
BV 409.00
Cilt ve vajinal ekartör
Skin and vaginal retractor
17.5 cm

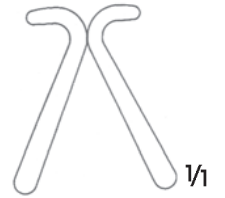

1/2

JACKSON-BURROWS
BV 415.00
Ekartör, künt/Retractor, blunt
18.5 cm



1/2

JOLL (FRIEDMANN)
BV 417.00
Tiroid ve vajinal ekartör
Thyroid and vaginal retractor
15.5 cm

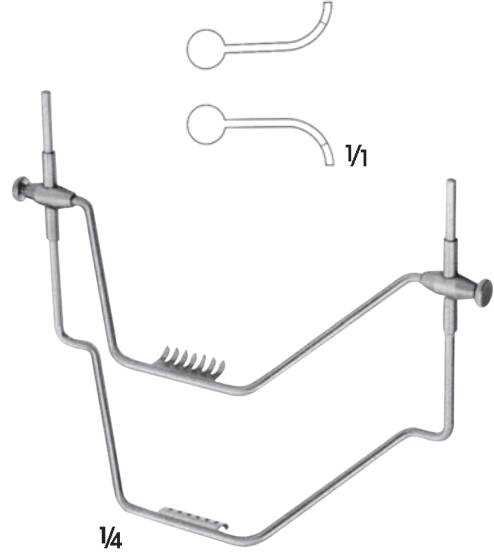

1/4

BV 419.00
Tiroid ekartörü
Thyroid retractor



1/2

TROUSSEAU
FA 040.01
Trakeal dilatör
Tracheal dilator
12 cm



1/2

LABORDE
FA 041.01
Trakeal dilatör
Tracheal dilator
12.5 cm



1/2

LABORDE
FA 042.01
Trakeal dilatör/Güçlü model
Tracheal dilator/Strong pattern
13.5 cm



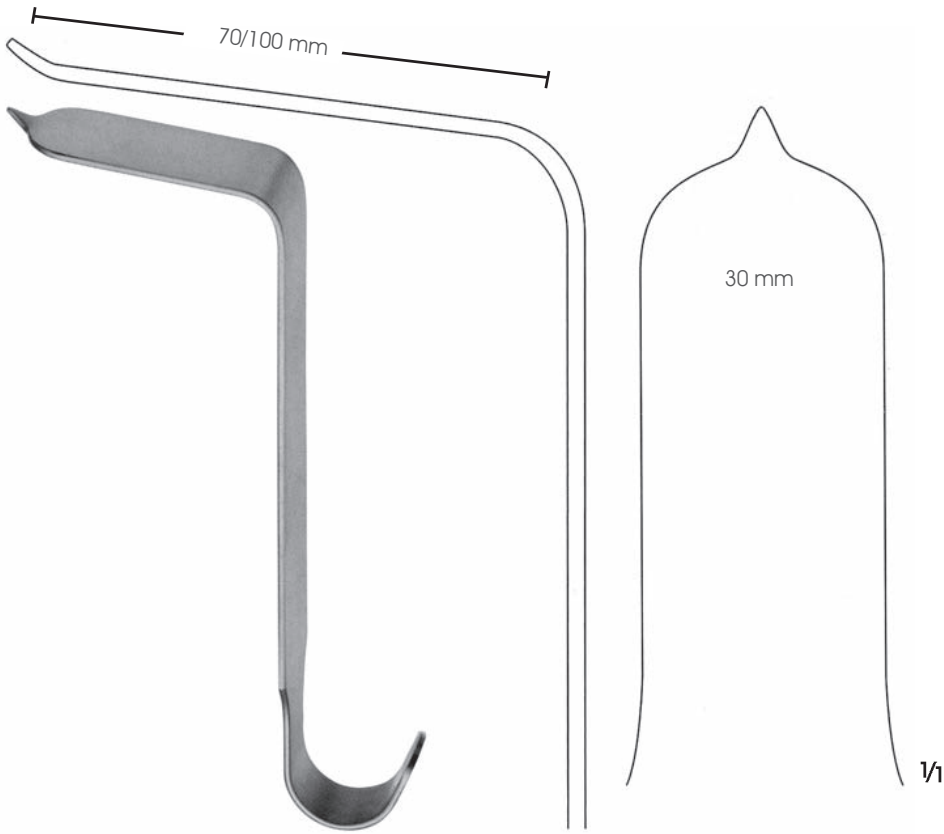

TAYLOR
BT 482.00
Bleyd boyu/Blade Size 30 x 70 mm
18.5 cm
BT 482.01
Bleyd boy/Blade Size 30 x 100 mm
20 cm



BALLANTINE
BT 484.00
32 x 90 mm
23 cm

TAYLOR-TURANTAN
BT 480.03
20 x 68 x 150 mm

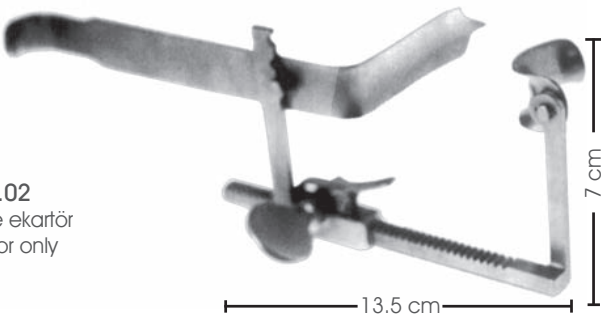

BT 480.02
Sadece ekartör
Retractor only



BT 480.05 20 x 20 mm
BT 480.06 30 x 20 mm
BT 480.07 36 x 20 mm

TURANTAN
BT 480.00 Komple/Complete
BT 480.02
BT 480.03-BT 480.05-BT 480.06-BT 480.07

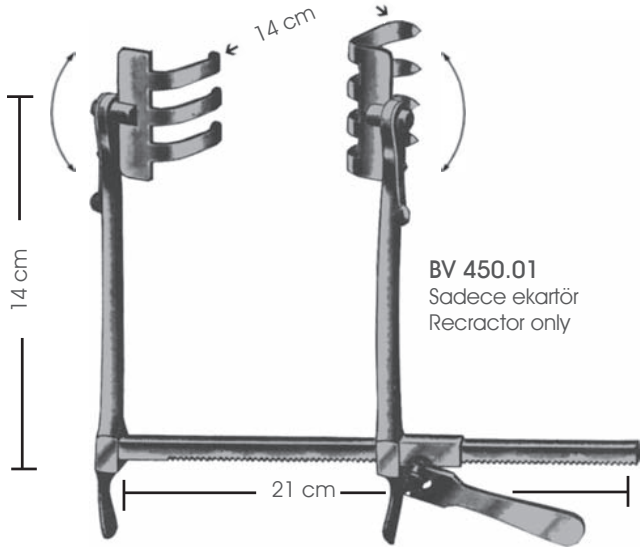

BV 450.01
Sadece ekartör
Retractor only

SCOVILLE-RICHTER
BV 450.00 Komple/Complete
BV 450.01
BV 450.04-BV 450.06-BV 450.08 BV 450.10-
BV 450.12-BV 450.14



BV 450.04 48 mm **BV 450.12** 48 x 30 mm **BV 450.08** 48 x 50 mm
BV 450.06 60 mm **BV 450.14** 60 x 30 mm **BV 450.10** 60 x 50 mm



BV 450.15 48 x 50 mm **BV 450.18** 38 x 62 mm **BV 450.20** 28 x 40 mm
BV 450.16 60 x 50 mm

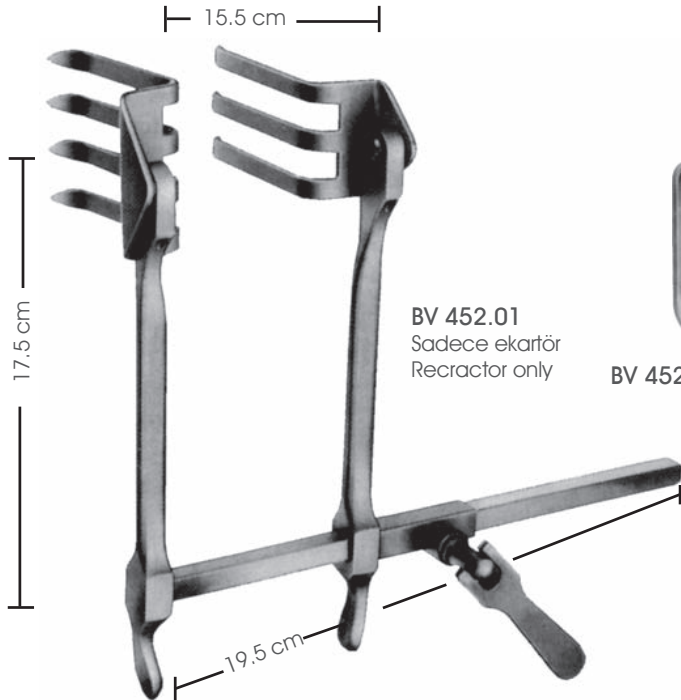

BV 452.01
Sadece ekartör
Retractor only

SCOVILLE-RICHTER
BV 452.00
Komple/Complete
BV 452.01-BV 452.04-BV 452.06-
BV 452.08 -BV 452.10 -BV 452.12



BV 452.04 62 x 37 mm



BV 452.06 62 x 52 mm



BV 452.08 47 x 51 mm



BV 452.10 30 x 40 mm



BV 452.12 37 x 62 mm



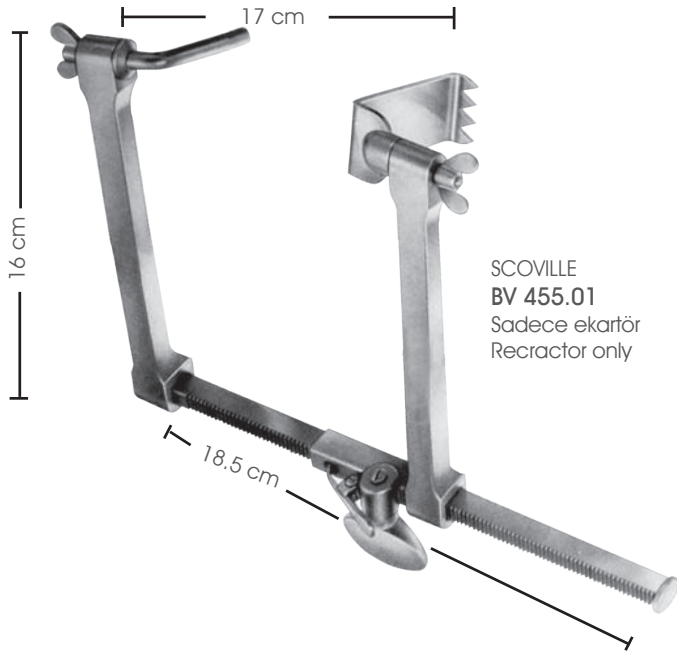

SCOVILLE
BV 455.01
Sadece ekartör
Retractor only

SCOVILLE
BV 455.06 Komple/Complete
BV 455.01
BV 455.40-L 455.45

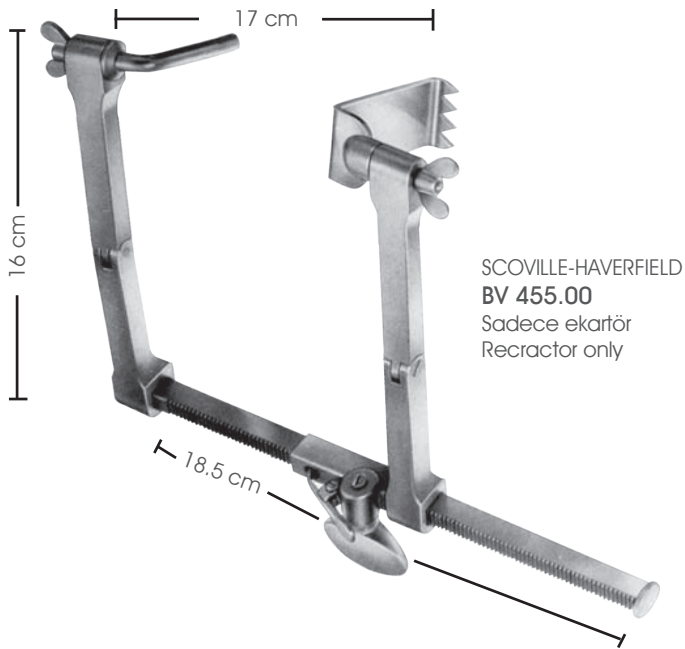

SCOVILLE-HAVERFIELD
BV 455.00
Sadece ekartör
Retractor only

SCOVILLE-HAVERFIELD
BV 455.05 Komple/Complete
BV 455.00
BV 455.40-L 455.45



SCOVILLE
BV 455.40 55 mm



SCOVILLE
BV 455.45 63 x 25 mm
BV 455.19 63 x 51 mm



TAYLOR
BV 455.51 47 x 37 mm



TAYLOR
BV 455.61 62 x 52 mm



BV 460.01
Sadece ekartör
Retractor only

CASPAR
BV 460.00 Komple/Complete
BV 460.01
BV 463.02-BV 463.15-BV
463.25-BV 463.35



BV 463.00 38 mm
BV 463.02 58 mm
Pimsiz/Without pins



BV 463.10 32 x 22 mm
BV 463.11 37 x 22 mm
BV 463.12 42 x 22 mm
BV 463.13 47 x 22 mm
BV 463.14 52 x 22 mm
BV 463.15 57 x 22 mm
BV 463.16 62 x 22 mm
BV 463.17 67 x 22 mm
Pimsiz/Without pins



BV 463.20 32 x 37 mm
BV 463.21 37 x 37 mm
BV 463.22 42 x 37 mm
BV 463.23 47 x 37 mm
BV 463.24 52 x 37 mm
BV 463.25 57 x 37 mm
BV 463.26 62 x 37 mm
BV 463.27 67 x 37 mm
Pimsiz/Without pins



BV 463.30 32 x 52 mm
BV 463.31 37 x 52 mm
BV 463.32 42 x 52 mm
BV 463.33 47 x 52 mm
BV 463.34 52 x 52 mm
BV 463.35 57 x 52 mm
BV 463.36 62 x 52 mm
BV 463.37 67 x 52 mm
Pimsiz/Without pins

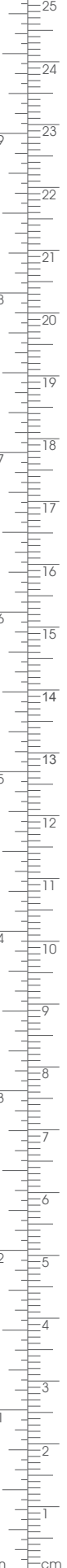

Üniversal Ekartör
Universal Retractor



BV 440.01 50 x 44 mm
BV 440.02 50 x 54 mm
BV 440.03 50 x 74 mm
BV 440.04 50 x 89 mm



FH 996.00
Ekartörleri yerleştirme kolu
Retractor placing handle

Spinal Ekartör
Spine Retractor

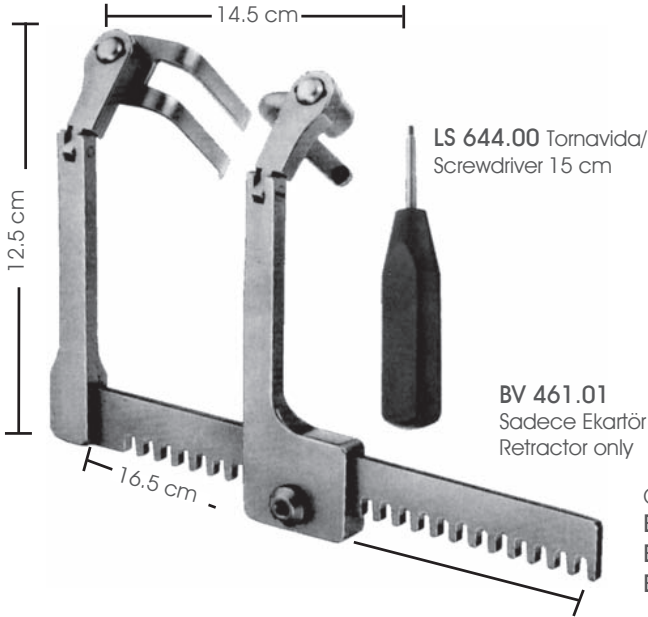

Üniversal spinal ekartör sistemi
Kendinden tutuculu Caspar üniversal omurga ekartörü,
güvenli bir ekartasyona izin verir ve sökülüp takılabilir saplar
sayesinde operasyon bölgesinde yer kazanırır.

Universal spinal retractor system
The self-retaining Caspar universal spinal retractor permits safe
retraction and saves in the operation area due to the remov-
able handles.

LS 644.00 Tornavida/
Screwdriver 15 cm

BV 461.01
Sadece Ekartör
Retractor only

CASPAR
BV 461.00 Komple/Complete
BV 461.01-BV 644.00
BV 463.52-BV 463.65-BV 463.75-BV 463.85



BV 463.50 38 mm
BV 463.52 58 mm
Pimli/Pins



BV 463.60 32 x 22 mm
BV 463.61 37 x 22 mm
BV 463.62 42 x 22 mm
BV 463.63 47 x 22 mm
BV 463.64 52 x 22 mm
BV 463.65 57 x 22 mm
BV 463.66 62 x 22 mm
BV 463.67 67 x 22 mm
Pimli/Pins



BV 463.70 32 x 37 mm
BV 463.71 37 x 37 mm
BV 463.72 42 x 37 mm
BV 463.73 47 x 37 mm
BV 463.74 52 x 37 mm
BV 463.75 57 x 37 mm
BV 463.76 62 x 37 mm
BV 463.77 67 x 37 mm
Pimli/Pins



BV 463.80 32 x 52 mm
BV 463.81 37 x 52 mm
BV 463.82 42 x 52 mm
BV 463.83 47 x 52 mm
BV 463.84 52 x 52 mm
BV 463.85 57 x 52 mm
BV 463.86 62 x 52 mm
BV 463.87 67 x 52 mm
Pimli/Pins

HARDCOATED



BV 486.02 40 mm BV 486.03 45 mm BV 486.04 50 mm BV 486.05 55 mm BV 486.06 60 mm BV 486.07 65 mm BV 486.09 75 mm BV 486.11 85 mm



CASPAR
BV 486.02-BV 486.11

HARDCOATED



BV 487.05 35 mm BV 487.06 40 mm BV 487.07 45 mm BV 487.08 50 mm BV 487.09 55 mm BV 487.10 60 mm BV 487.11 65 mm BV 487.13 75 mm BV 487.15 85 mm



BV 488.06 40 mm BV 488.07 45 mm BV 488.08 50 mm BV 488.09 55 mm BV 488.10 60 mm BV 488.11 65 mm BV 488.12 70 mm

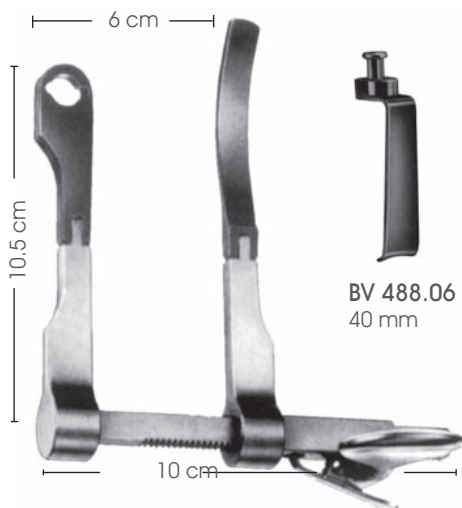

BV 487.01 Sadece ekartör
Retractor only

CASPAR
BV 487.00 Komple/Complete
BV 487.01-BV 487.05-BV
487.15

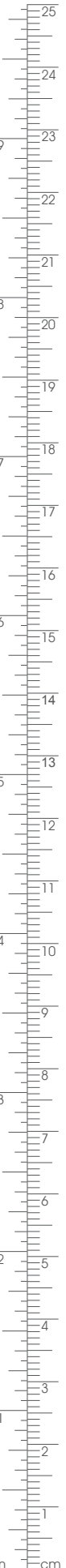

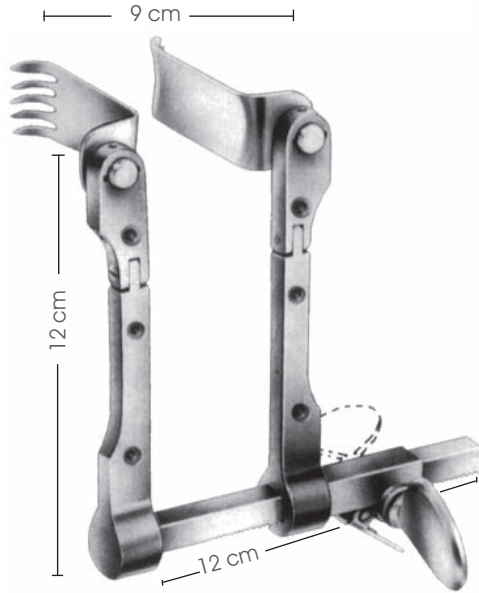

CASPAR
BV 465.00
BV 465.01 Sadece ekartör/Retractor
only (BV 471.00-BV 471.04)

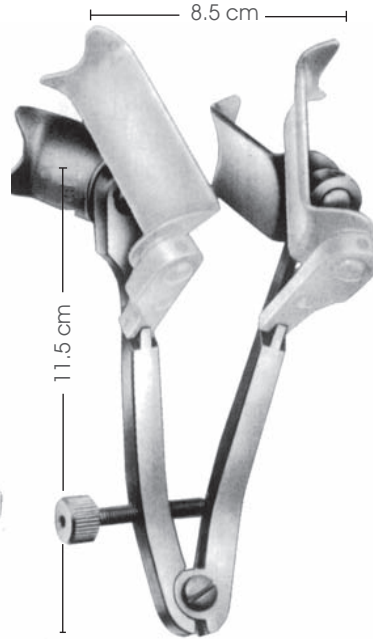

CASPAR
BV 467.00
BV 467.01 Sadece ekartör/Retractor
only (BV 472.00-BV 472.05)



CASPAR
BV 469.00
BV 469.01 Sadece ekartör/Retractor
only (BV 472.00-BV 472.05)



BV 470.00 40 x 23 mm
BV 470.01 45 x 23 mm
BV 470.02 50 x 23 mm
BV 470.03 55 x 23 mm
BV 470.04 60 x 23 mm



BV 471.00 40 x 23 mm
BV 471.01 45 x 23 mm
BV 471.02 50 x 23 mm
BV 471.03 55 x 23 mm
BV 471.04 60 x 23 mm



BV 472.00 40 x 23 mm
BV 472.01 45 x 23 mm
BV 472.02 50 x 23 mm
BV 472.03 55 x 23 mm
BV 472.04 60 x 23 mm
BV 472.05 65 x 23 mm



BV 470.06 40 x 25 mm
BV 470.07 45 x 25 mm
BV 470.08 50 x 25 mm
BV 470.09 55 x 25 mm
BV 470.10 60 x 25 mm



BV 471.06 40 x 25 mm
BV 471.07 45 x 25 mm
BV 471.08 50 x 25 mm
BV 471.09 55 x 25 mm
BV 471.10 60 x 25 mm



BV 472.08T 30 x 24 mm
BV 472.09T 35 x 24 mm
BV 472.10T 40 x 24 mm
BV 472.11T 45 x 24 mm
BV 472.12T 50 x 24 mm
BV 472.13T 55 x 24 mm
BV 472.14T 60 x 24 mm
BV 472.15T 65 x 24 mm
BV 472.16T 70 x 24 mm
BV 472.17T 75 x 24 mm
Titanyum bleyd Titanium
blades



BV 474.10T 25 x 24 mm
BV 474.11T 30 x 24 mm
BV 474.12T 35 x 24 mm
BV 474.13T 40 x 24 mm
BV 474.14T 45 x 24 mm
BV 474.15T 50 x 24 mm
BV 474.16T 55 x 24 mm
BV 474.17T 60 x 24 mm
BV 474.18T 65 x 24 mm
BV 474.19T 70 x 24 mm
Titanyum bleyd Titanium
blades



BV 474.21T 25 x 24 mm
BV 474.22T 30 x 24 mm
BV 474.23T 35 x 24 mm
BV 474.24T 40 x 24 mm
BV 474.25T 45 x 24 mm
BV 474.26T 50 x 24 mm
BV 474.27T 55 x 24 mm
BV 474.28T 60 x 24 mm
BV 474.29T 65 x 24 mm
BV 474.30T 70 x 24 mm
Titanyum bleyd Titanium
blades



BV 474.00 50 x 25 mm
BV 474.01 60 x 25 mm



BD 610.00
Bleyd tutma
pensi
Blade ejector
forceps
11.5 cm

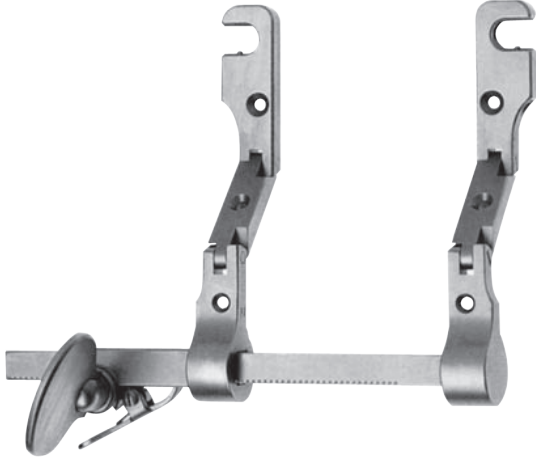

BV 465.05
Çift hareketli servikal ekartör
Double hinged cervical retractor



BV 469.05
Çift hareketli karşı ekartör
Double hinged retractor used for
longitudinal retraction



BV 467.05
Karşı ekartör
Counter retractor



BV 470.50T 30 x 24 mm
BV 470.51T 35 x 24 mm
BV 470.52T 40 x 24 mm
BV 470.53T 45 x 24 mm
BV 470.54T 50 x 24 mm
BV 470.55T 55 x 24 mm
BV 470.56T 60 x 24 mm
BV 470.57T 65 x 24 mm
BV 470.58T 70 x 24 mm
Titanyum orta bleyd
Mediall blades titanium



BV 471.50T 30 x 24 mm
BV 471.51T 35 x 24 mm
BV 471.52T 40 x 24 mm
BV 471.53T 45 x 24 mm
BV 471.54T 50 x 24 mm
BV 471.55T 55 x 24 mm
BV 471.56T 60 x 24 mm
BV 471.57T 65 x 24 mm
BV 471.58T 70 x 24 mm
Titanyum yan bleyd
Lateral blades titanium



BV 472.50T 35 x 24 mm
BV 472.51T 40 x 24 mm
BV 472.52T 45 x 24 mm
BV 472.53T 50 x 24 mm
BV 472.54T 55 x 24 mm
BV 472.55T 60 x 24 mm
BV 472.56T 65 x 24 mm
BV 472.57T 70 x 24 mm
BV 472.58T 75 x 24 mm
Titanyum künt bleyd Blunt
blades titanium



BV 474.50T 30 x 24 mm
BV 474.51T 35 x 24 mm
BV 474.52T 40 x 24 mm
BV 474.53T 45 x 24 mm
BV 474.54T 50 x 24 mm
BV 474.55T 55 x 24 mm
BV 474.56T 60 x 24 mm
BV 474.57T 65 x 24 mm
BV 474.58T 70 x 24 mm
Titanyum orta bleyd
Mediall blades titanium



BV 473.50T 30 x 24 mm
BV 473.51T 35 x 24 mm
BV 473.52T 40 x 24 mm
BV 473.53T 45 x 24 mm
BV 473.54T 50 x 24 mm
BV 473.55T 55 x 24 mm
BV 473.56T 60 x 24 mm
BV 473.57T 65 x 24 mm
BV 473.58T 70 x 24 mm
Titanyum yan bleyd
Lateral blades titanium

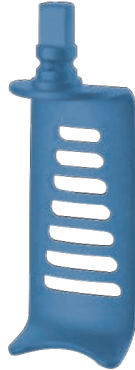

BV 475.50T 35 x 24 mm
BV 475.51T 40 x 24 mm
BV 475.52T 45 x 24 mm
BV 475.53T 50 x 24 mm
BV 475.54T 55 x 24 mm
BV 475.55T 60 x 24 mm
BV 475.56T 65 x 24 mm
BV 475.57T 70 x 24 mm
BV 475.58T 75 x 24 mm
Titanyum künt bleyd Blunt
blades titanium



BV 476.50T 25 x 19 mm
BV 476.51T 30 x 19 mm
BV 476.52T 35 x 19 mm
BV 476.53T 40 x 19 mm
BV 476.54T 45 x 19 mm
BV 476.55T 50 x 19 mm
BV 476.56T 55 x 19 mm
BV 476.57T 60 x 19 mm
Titanyum dişli bleyd Teeth
blades titanium



BV 477.50T 25 x 19 mm
BV 477.51T 30 x 19 mm
BV 477.52T 35 x 19 mm
BV 477.53T 40 x 19 mm
BV 477.54T 45 x 19 mm
BV 477.55T 50 x 19 mm
BV 477.56T 55 x 19 mm
BV 477.57T 60 x 19 mm
Titanyum künt bleyd Blunt
blades titanium



FH 995.00P
Bleyd tutucu elçek
Handle for blades with side load
attachment

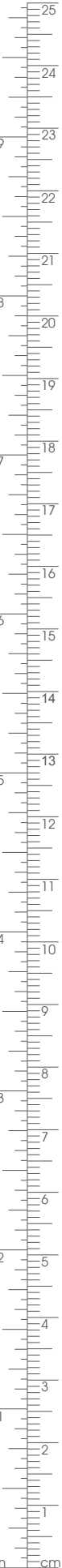



CLOWARD
BV 490.01
 Sadece ekartör
 Retractor only
 25 cm



CLOWARD
BV 491.00
 Sadece ekartör
 Retractor only
 15 cm

CLOWARD
BV 490.00 Komple/Complete
 BV 490.01
 BV 490.05-BV 491.09

CLOWARD
BV 491.01 Komple/Complete
 BV 491.00
 BV 491.05-BV 491.06-BV 491.07
 BV 491.08-BV 491.09

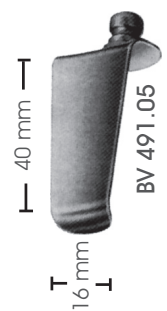
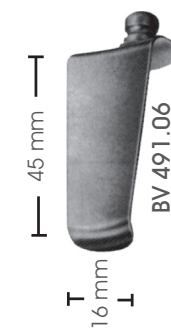
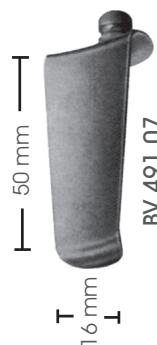
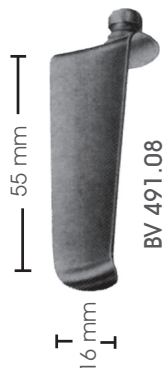
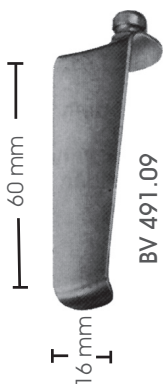
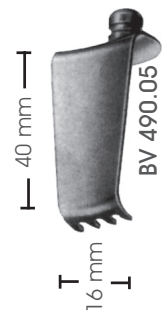
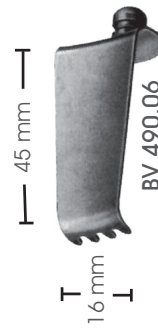
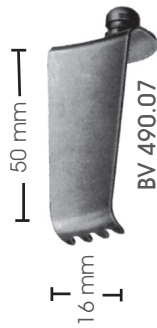
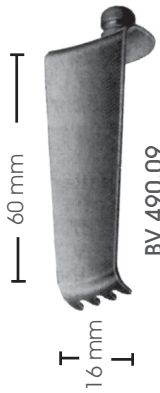

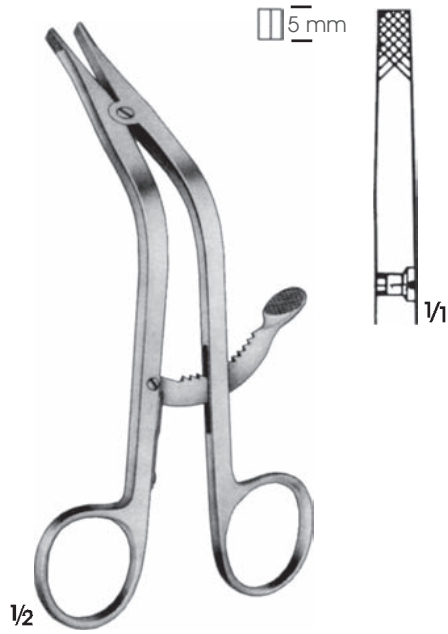

CLOWARD
BV 494.00
15.5 cm



CLOWARD
BV 495.00
13.5 cm



INGE
BV 497.00
17 cm

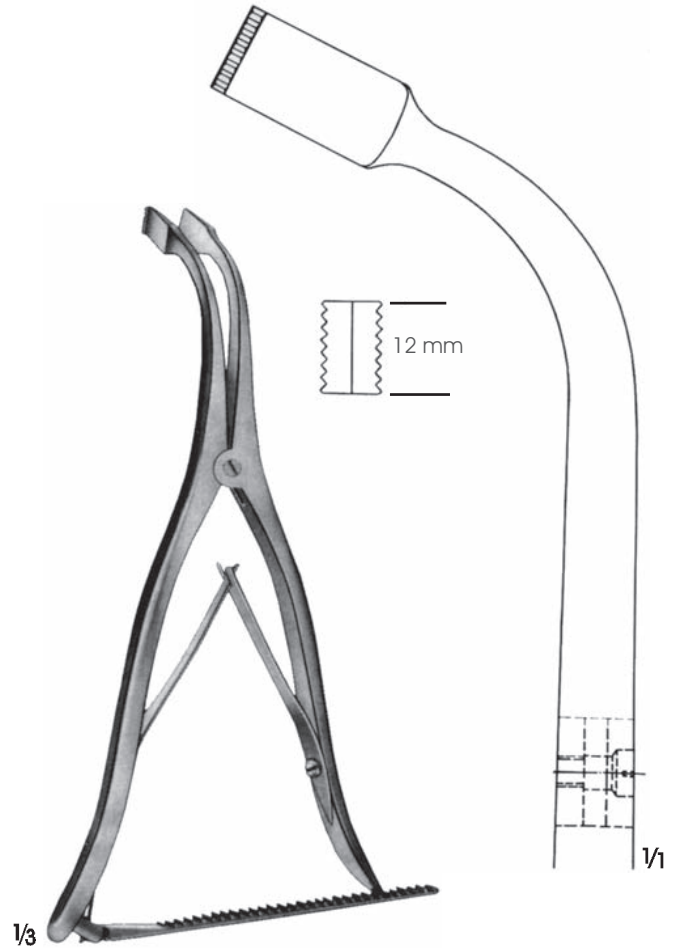

INGE
BV 498.00
27.5 cm

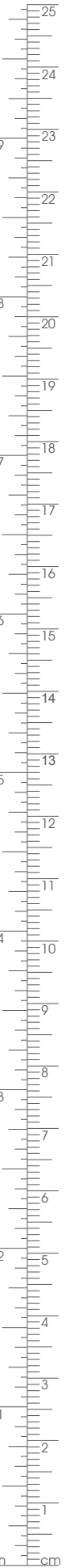



BABY-COLLIN
BV 500.00 Komple/Complette
BV 500.01 Sadece ekartör Retractor only
BV 500.10 18 x 42 mm bleyd çift/blades pair
BV 500.11 28 x 42 mm bleyd çift/blades pair



COLLIN
BV 501.00 Komple/Complette
BV 501.01 Sadece ekartör Retractor only
BV 560.00 Yan bleyd çift Lateral blades pair



COLLIN
BV 503.01-BV 503.03



COLLIN
BV 502.00-BV 502.01

Sadece ekartör Retractor only	BV 503.01 BV 503.06	BV 503.02 BV 503.07	BV 503.03 BV 503.07
Yan bleyd (çift) Lateral blades (pair)	BV 560.00 37 x 62 mm	BV 560.01 37 x 80 mm	BV 560.02 37 x 98 mm
Orta bleyd Center blade	BV 580.03 54 x 55 mm	BV 580.04 54 x 67 mm	BV 580.05 52 x 76 mm

Sadece ekartör Retractor only	BV 502.00 BV 502.04	BV 502.01 BV 502.04
Yan bleyd (çift) Lateral blades (pair)	BV 560.04 48 x 59 mm	BV 560.03 61 x 80 mm
Orta bleyd Center blade	BV 580.00 63 x 74 mm	BV 580.00 63 x 74 mm

32 cm



RICARD
BV 506.00-BV 506.01

Sadece ekartör
Retractor only
Yan bleyd (çift) Lateral
blades (pair) Orta bleyd
Center blade

BV 506.00
BV 506.04

BV 506.01
BV 506.04

BV 560.05
58 x 80 mm
BV 580.10
54 x 70 mm

BV 560.06
72 x 84 mm
BV 580.11
72 x 90 mm

26.5 cm



ROBIN-MASSE
BV 505.00
Komple/Complete

Sadece ekartör
Retractor only
Yan bleyd (çift)
Lateral blades (pair)
Orta bleyd
Center blade

BV 505.01

BV 560.00
37 x 62 mm
BV 580.08
38 x 68 mm

27.5 cm



HOLZBACH
BV 508.00
Komple/Complete

Sadece ekartör
Retractor only
Yan bleyd (çift)
Lateral blades (pair)
Orta bleyd
Center blade

BV 508.01

BV 560.07
59 x 80 mm
BV 580.16
74 x 82 mm



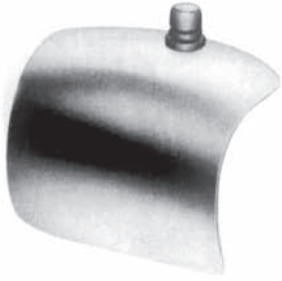

BV 560.04 48 x 59 mm
BV 560.05 58 x 80 mm
BV 560.06 72 x 84 mm
Yan bleyd (çift) Lateral
blades (pair)

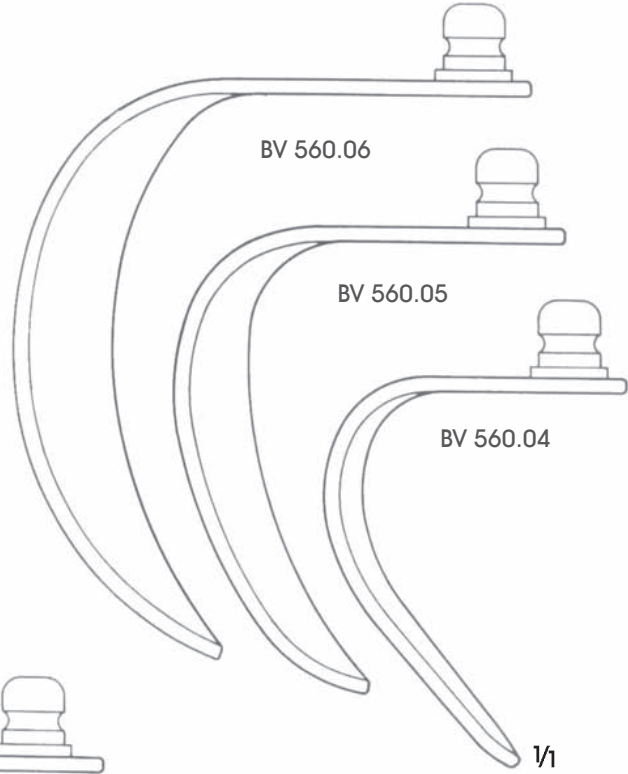

BV 560.07 59 x 80 mm
Yan bleyd (çift) Lateral
blades (pair)



BV 560.00 37 x 62 mm
BV 560.01 37 x 80 mm
BV 560.02 37 x 98 mm
Yan bleyd (çift) Lateral
blades (pair)

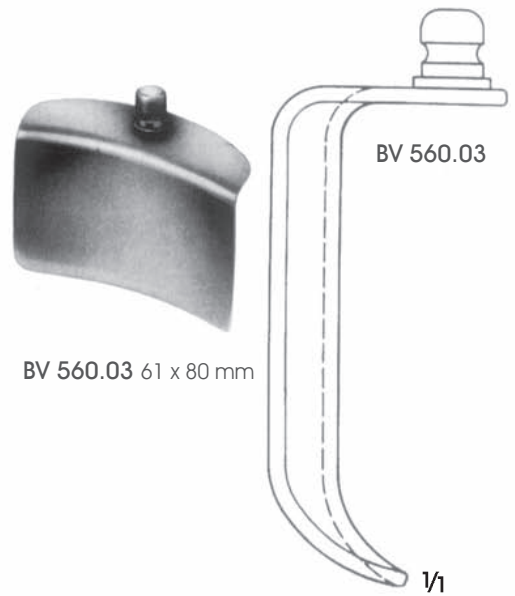
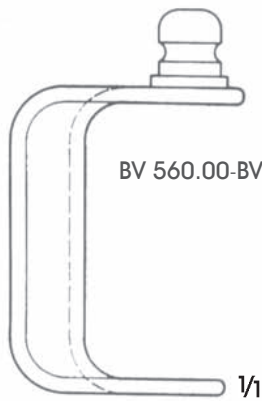

BV 560.03 61 x 80 mm



GOSSET
BV 520.00
Bleyd/Blades 38 mm

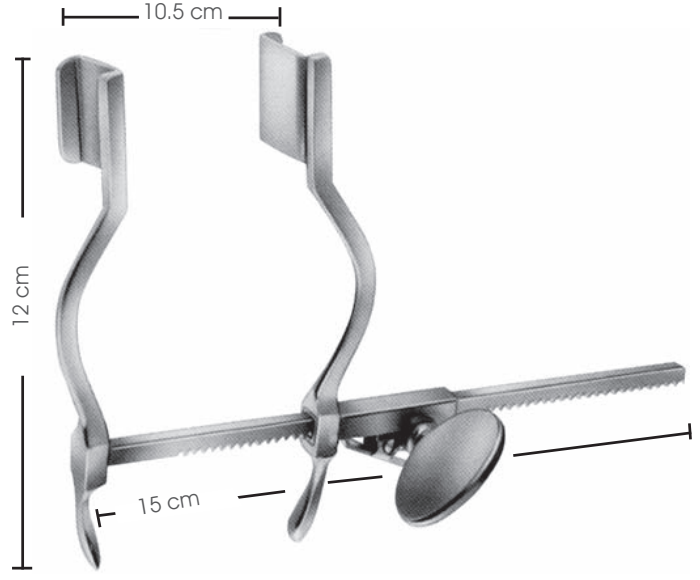

HERTZLER
BV 522.00
Bleyd/Blades
20 x 25 mm

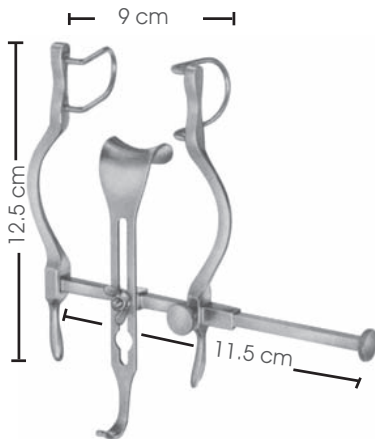

BALFOUR-BABY
BV 524.00
Yan bleyd/Lateral blades 27 mm
Orta bleyd L 580.20
Center blade 21 x 24 mm



GOSSET
BV 525.00
Bleyd/Blades 55 mm





GOSSET
BV 528.00
Yan bleyd/Lateral blades 58 mm
Orta bleyd L 580.22
Center blade 59 x 57 mm

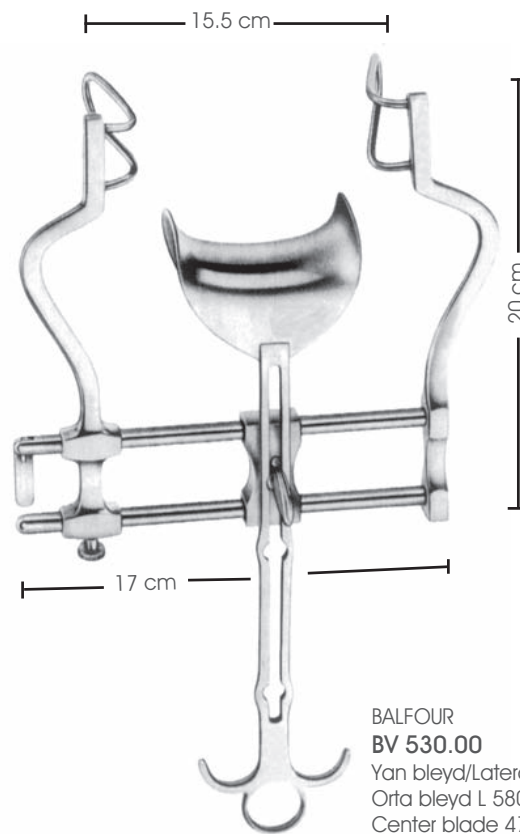

BALFOUR
BV 530.00
Yan bleyd/Lateral blades 60 mm
Orta bleyd L 580.25
Center blade 47 x 80 m

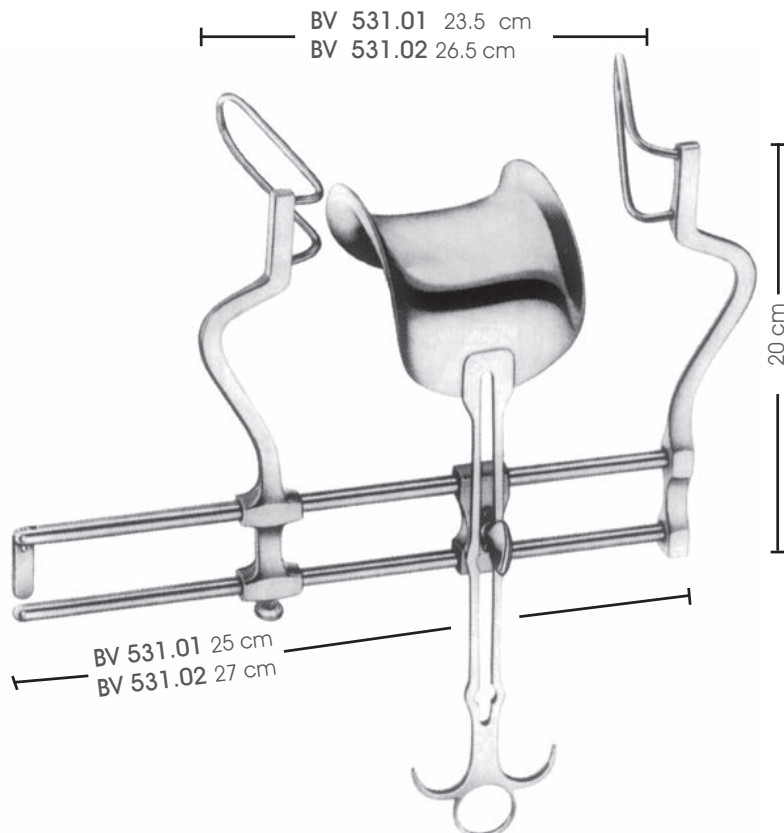

BALFOUR
BV 531.01-BV 531.02

	BV 531.01	BV 531.02
Yan bleyd Lateral blades	60 mm	90 mm
Orta bleyd Center blade	BV 580.26 62 x 76 mm	BV 580.27 80 x 80 mm

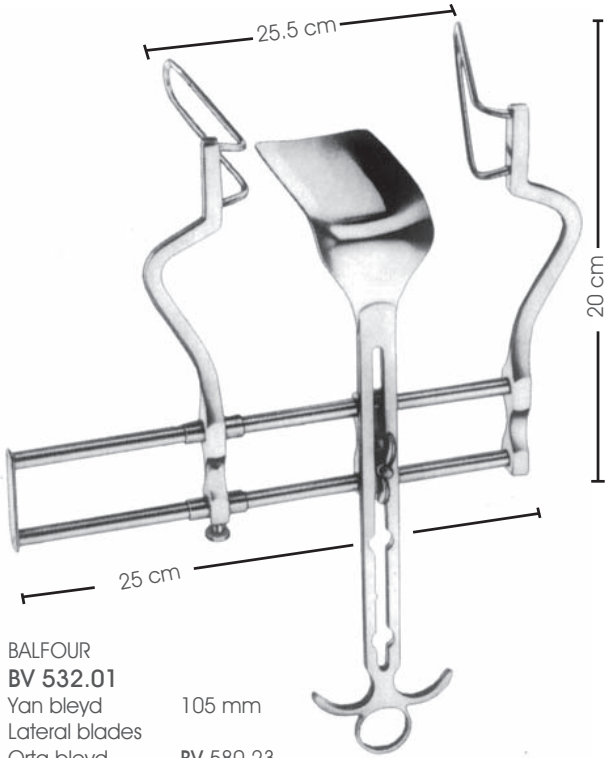

BALFOUR
BV 532.01
Yan bleyd
Lateral blades 105 mm
Orta bleyd
Center blade **BV 580.23**
107 x 59 mm



BV 580.30
Orta bleyd
Center blade
54 x 80 mm



BV 580.40
Orta bleyd, prostatektomi için kanallı 75 x 80 mm
Center blade, slotted for retropubie prostatectomy
75 x 80 mm

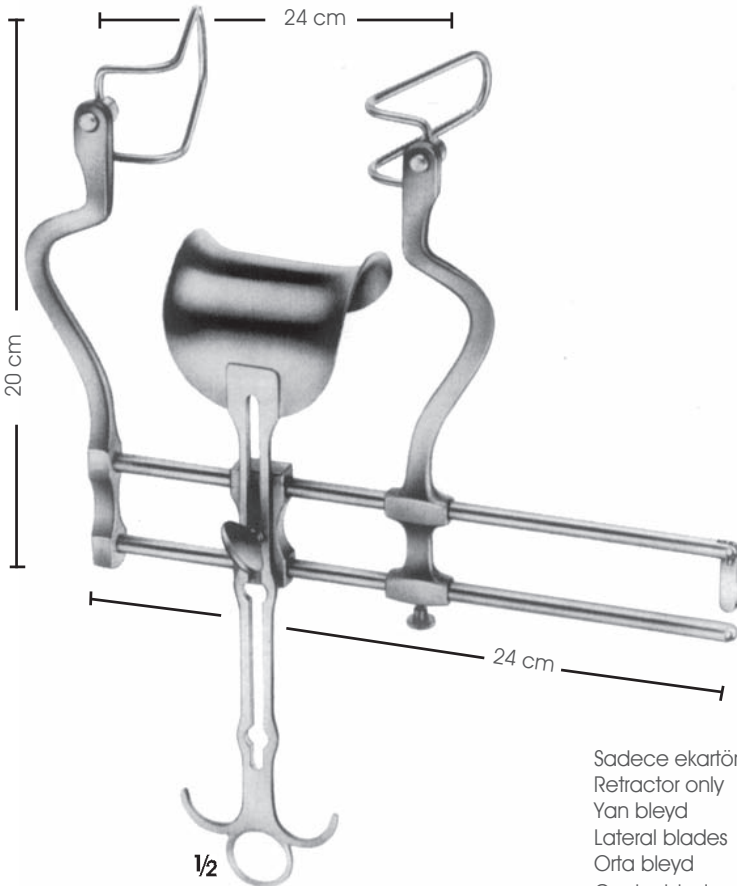

BALFOUR
BV 534.00-BV 534.03
Komple/Complete

Sadece ekartör
Retractor only
Yan bleyd
Lateral blades
Orta bleyd
Center blade

BV 534.00	BV 534.01	BV 534.02	BV 534.03
BV 534.20	BV 534.20	BV 534.20	BV 534.20
BV 560.10	BV 560.11	BV 560.12	BV 560.13
50 mm	60 mm	75 mm	90 mm
BV 580.25	BV 580.26	BV 580.27	BV 580.27
47 x 80 mm	62 x 76 mm	80 x 80 mm	80 x 80 mm



BV 560.10 50 mm
BV 560.11 60 mm
BV 560.12 75 mm
BV 560.13 90 mm
Yan Bleyd/Lateral Blades





GOLIGHER
BV 529.00
Komple/Complete
Orta bleyd/Center blade 51 mm
Orta bleyd/Center blade 102 mm
Yan bleyd(bir çift)/Lateral blades(pair) 51 mm
Yan bleyd(bir çift)/Lateral blades(pair) 102 mm



BV 604.01
Sadece ekartör
Retractor only

O'SULLIVAN-O' CONNOR
BV 604.00 Komple/Complete
BV 604.01
BV 604.10 (2 adet)-L 604.11(1 adet)



O'SULLIVAN-O' CONNOER
BV 604.10
Küçük bleyd/Small blade



O'SULLIVAN-O' CONNOER
BV 604.11
Büyük bleyd/Large blade

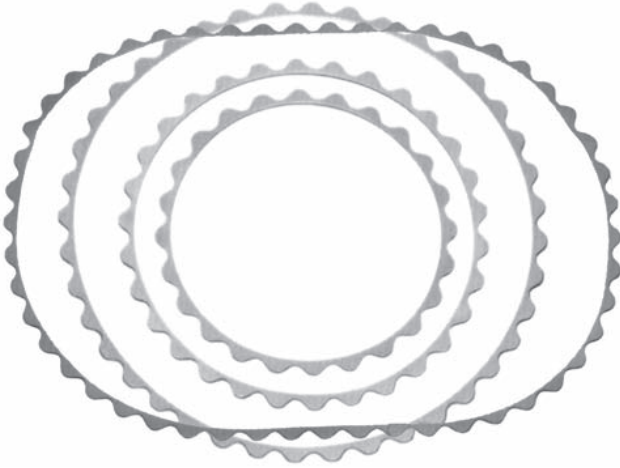

TURNER-WARWICK
BV 605.01 Ø 18 cm
BV 605.02 Ø 23 cm
BV 605.03 Ø 30.5 cm
Ekartör çerçevesi, yuvarlak
Retractor frame, round
BV 605.10
Ekartör çerçevesi, oval
Retractor frame, oval
457 x 330 mm

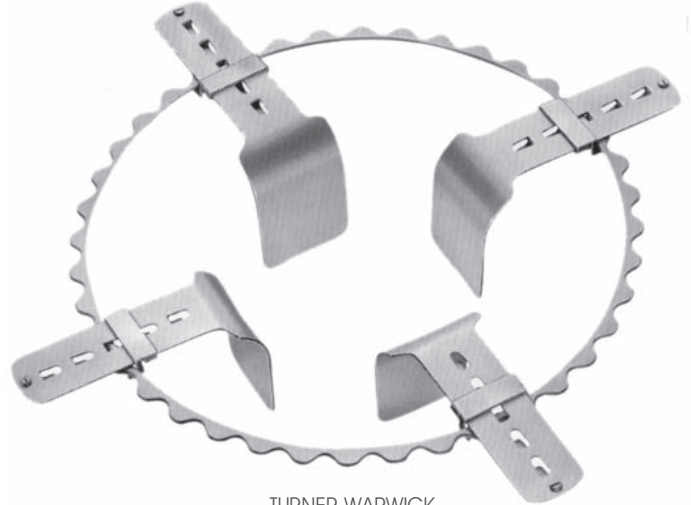

TURNER-WARWICK
BV 605.00 Komple/Complete
BV 605.01 1 adet/1 each
BV 605.03 1 adet/1 each
BV 605.30 2 adet/2 each
BV 605.40 2 adet/2 each
BV 605.22 2 adet/2 each
BV 605.25 2 adet/2 each
BV 605.27 2 adet/2 each
BV 605.28 2 adet/2 each
BV 605.20 2 adet/2 each

BV 605.20
13 mm



BV 605.22
51 x 38 mm



BV 605.25
76 x 60 mm



BV 605.27
89 x 60 mm



BV 605.28
114 x 60 mm



BV 605.30
Bükülebilir/Malleable
76 x 19 mm



BV 605.33
Bükülebilir/Malleable
102 x 38 mm



BV 605.35
Bükülebilir/Malleable
89 x 57 mm



BV 605.40
Bükülebilir/Malleable
114 x 57 mm



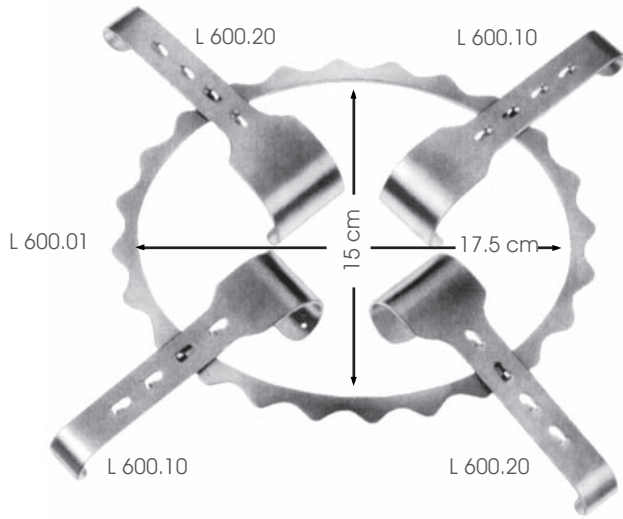

DENNIS-BROWNE
BV 600.00
Komple/Complete

BV 600.01 175 x 150 mm Çember/Frame
BV 600.10 40 x 30 mm 2 adet bleyd/2 each blades
BV 600.20 40 x 40 mm 2 adet bleyd/2 each blades



BV 600.30
1 adet bleyd
1 each blade
20 x 30 mm

BV 600.32
1 adet bleyd
1 each blade
20 x 40 mm

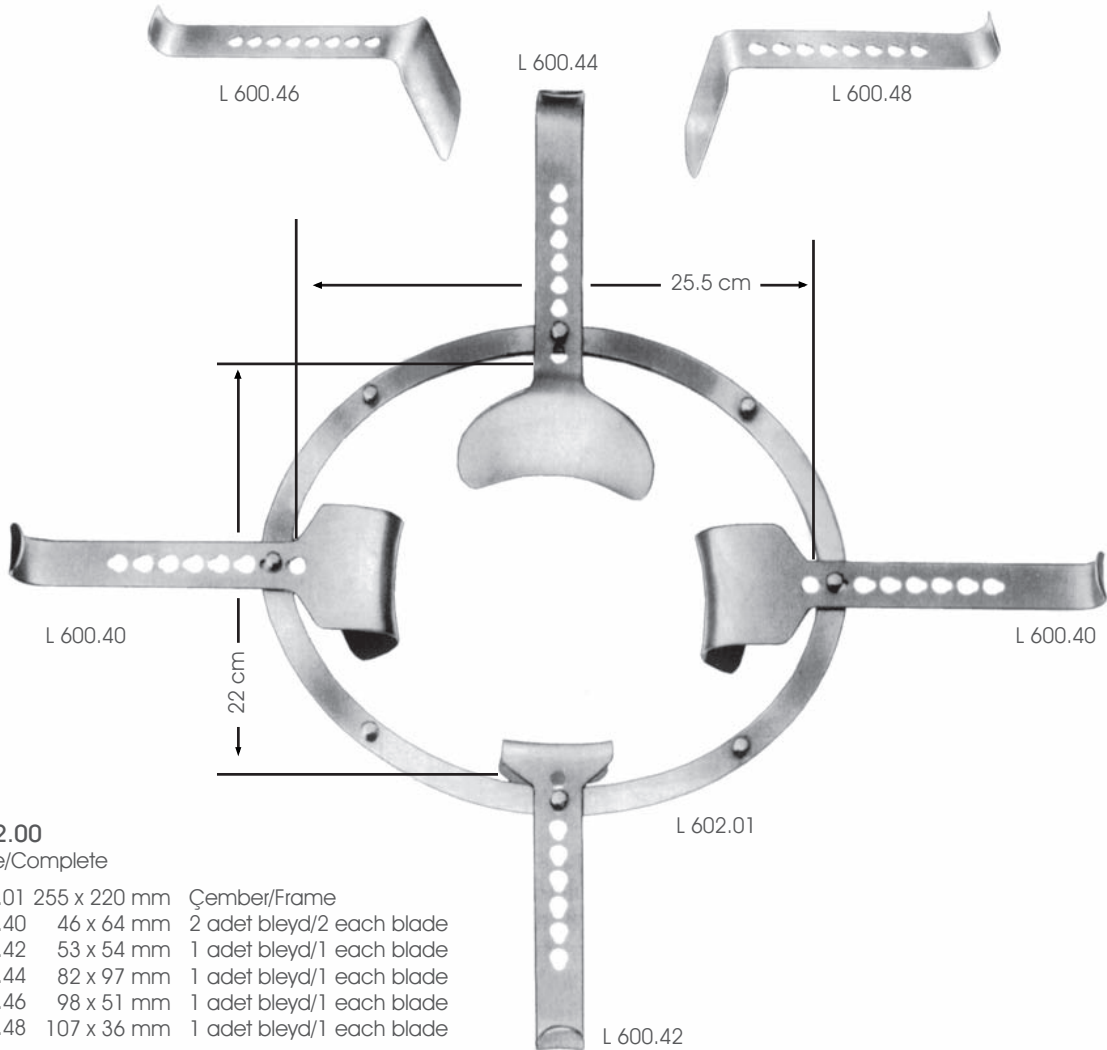

SEMM
BV 602.00
Komple/Complete

BV 602.01 255 x 220 mm Çember/Frame
BV 600.40 46 x 64 mm 2 adet bleyd/2 each blade
BV 600.42 53 x 54 mm 1 adet bleyd/1 each blade
BV 600.44 82 x 97 mm 1 adet bleyd/1 each blade
BV 600.46 98 x 51 mm 1 adet bleyd/1 each blade
BV 600.48 107 x 36 mm 1 adet bleyd/1 each blade

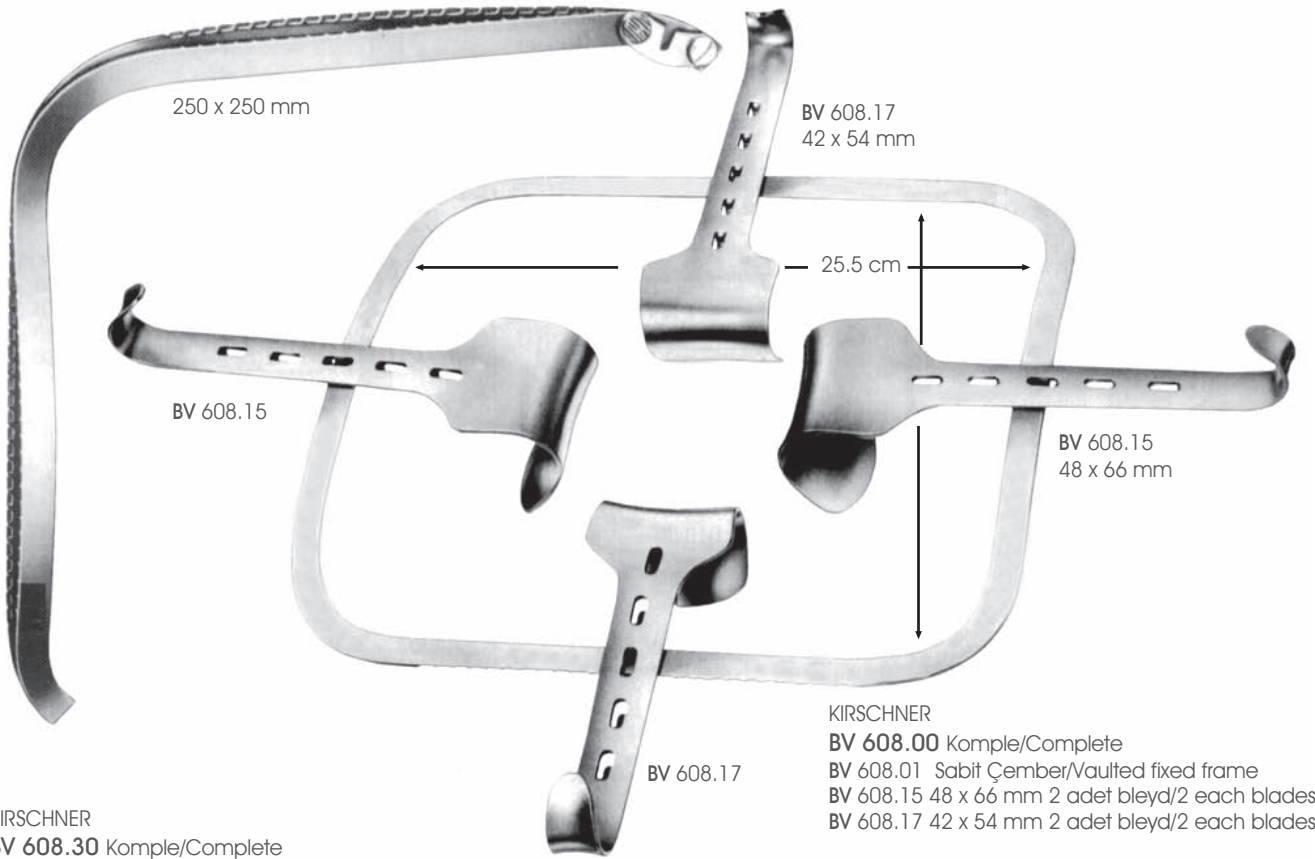

KIRSCHNER

BV 608.30 Komple/Complete

BV 608.31 Katlanabilir/Holding frame

BV 608.15 48 x 66 mm 2 adet bleyd/2 each blades

BV 608.17 42 x 54 mm 2 adet bleyd/2 each blades

KIRSCHNER

BV 608.00 Komple/Complete

BV 608.01 Sabit Çember/Vaulted fixed frame

BV 608.15 48 x 66 mm 2 adet bleyd/2 each blades

BV 608.17 42 x 54 mm 2 adet bleyd/2 each blades

BV 608.04 275 x 355 mm

Büyük ölçekli çerme
Frame only, over-sized

BV 608.06 295 x 275 mm

Sadece Çember/Frame only



KIRSCHNER
BV 608.50
64 x 80 mm



KIRSCHNER-BALFOUR
BV 608.52
80 x 82 mm



KIRSCHNER
BV 608.54 90 x 69 mm
BV 608.56 95 x 95 mm
BV 608.58 78 x 58 mm



KIRSCHNER
BV 608.64 108 x 42 mm
BV 608.66 91 x 55 mm
BV 608.68 120 x 55 mm





BV 403.06
60 x 50 mm



BV 403.03
40 x 35 mm



BV 515.05
57 x 25 mm



BV 403.00 Komple/Complete
Popliteal Ekartör/Popliteal Retractor
BV 403.03 Sadece ekartör/Retractor only
BV 403.06 Bleyd çift, künt 60 x 50 mm
Blades pair blunt 60 x 50 mm
Bleyd çift, yarı sivri, 40 x 35 mm
Blades pair semi-sharp 40 x 35 mm



L 515.06
82 x 25 mm

MILLIN
BV 515.00 Komple/Complete
Mesane Ekartörü/Bladder Retractor
BV 515.02 Sadece ekartör/Retractor only
BV 515.05 Bleyd 57 x 25 mm/Blades 57 x 25 mm
BV 515.06 Bleyd 82 x 25 mm/Blades 82 x 25 mm
BV 515.11 Orta bleyd 105 x 45 mm
Center blade 105 x 45 mm



LEGUEU
BV 723.00
Mesane spatulası
Bladder spatula
26 cm



ALLENBERG
BV 903.01
Sadece ekartör
Retractor only

ALLENBERG
BV 903.00
İliak ekartörü komple
Iliaca retractor complete
BV 903.01 Sadece ekartör/Retractor only
BV 903.03T Yan Bleyd/Lateral Blade 30 x 30 mm
BV 903.04T Orta Bleyd/Medial Blade 90 x 60 mm



ALLENBERG
BV 903.03T
Yan Bleyd/Lateral Blade
Titanyum/Titanium
30 x 30 mm



ALLENBERG
BV 903.04T
Orta Bleyd/Medial Blade
Titanyum/Titanium
90 x 60 mm



ALLENBERG
FM 582.00
Bleyd değiştirmek için penset
Forceps for changing the blades
13 cm

Arteria iliaca communis'e optimum yaklaşım için ekartör.

Bleydleri titanyumdan yapılmıştır ve bu sebeple x ışını geçirgendir. Büyük ekartör bleydi operasyon esnasında kademeli olarak ayarlanabilir. Ekartör bleydlerin kolaylıkla değiştirilebiliyor olması ekartör sisteminin sağ taraftan ve sol taraftan kullanımını sağlar.

Retractor system for optimal approach to the arteria iliaca communis.

The retractor blades are made out of titanium and therefore they are radiotransparent. The big medial retractor blade can be gradually adjusted during the operation. Because of the blades which are easy to exchange the retractor system can be used for the left and the right side.



GC Genel Cerrahi
General Surgery



 **ARGENT**

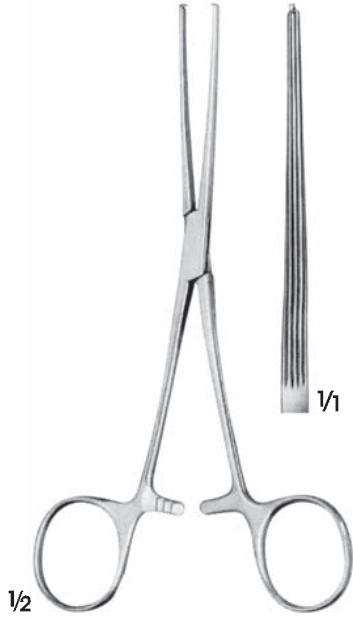

ALLEN
EA 330.00
15.5 cm



BAINBRIDGE
EA 332.00-EA 333.00
15.5 cm



DOYEN
EA 335.00-EA 336.00
Elastik/Elastic
16.5 cm

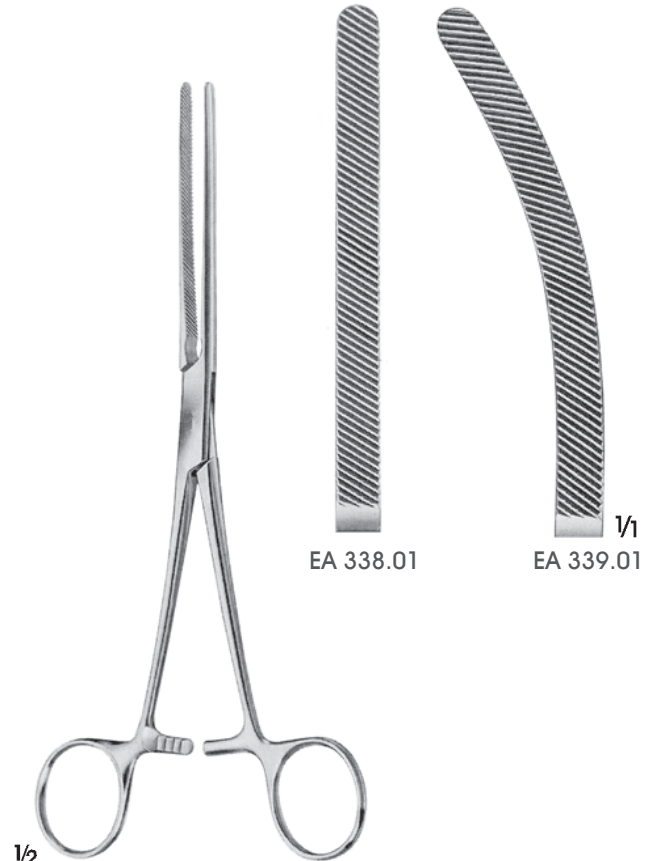

HARTMANN
EA 338.01-EA 339.01
Yumuşak ve elastik Soft
and elastic
20 cm



BABY-KOCHER
EA 345.00-EA 346.00
Çocuklar için/For children
Çok elastik/Very elastic
13 cm

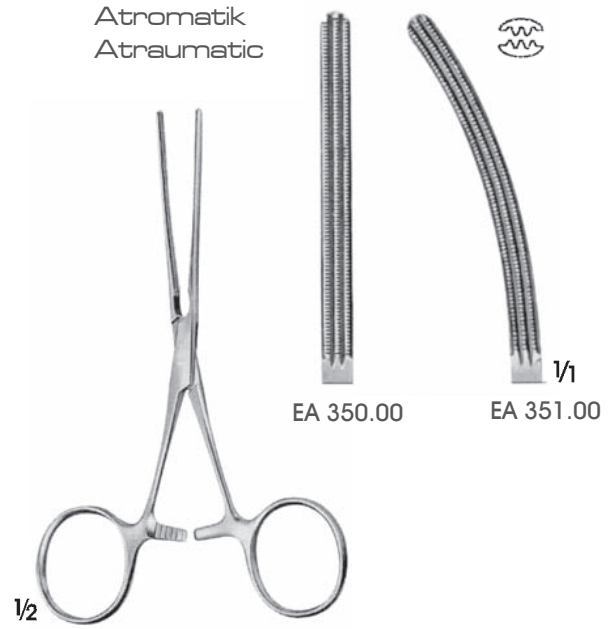

BABY-KOCHER
EA 350.00-EA 351.00
Çocuklar için/For children
Yumuşak ve elastik/ Soft and elastic
13 cm

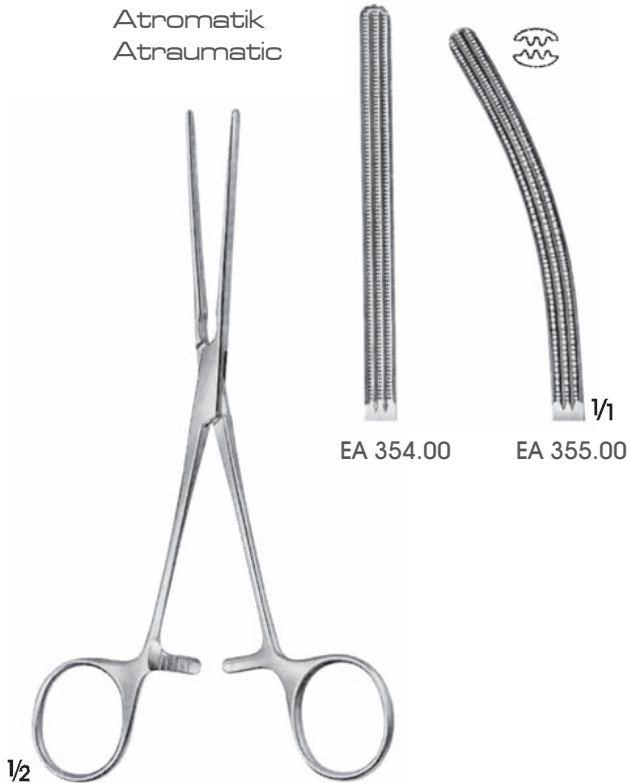

DOYEN
EA 354.00-EA 355.00
Yumuşak ve elastik Soft
and elastic
17 cm

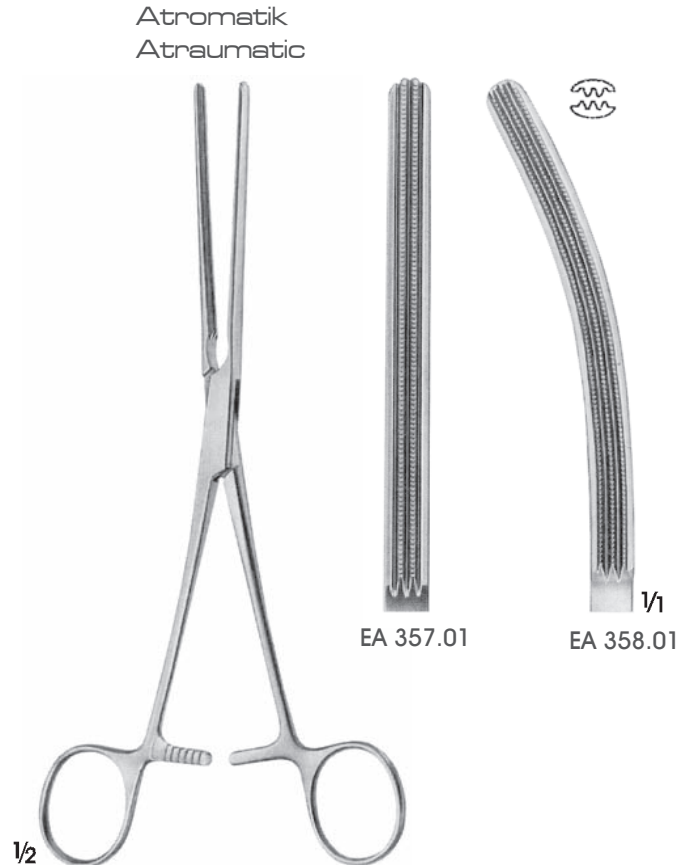

HARTMANN
EA 357.01-EA 358.01
Yumuşak ve elastik Soft
and elastic
20 cm





Atromatik
Atraumatic



EA 365.02

EA 366.02

1/2

DOYEN
EA 365.02-EA 366.02
Yumuşak ve elastik Soft
and elastic
23 cm

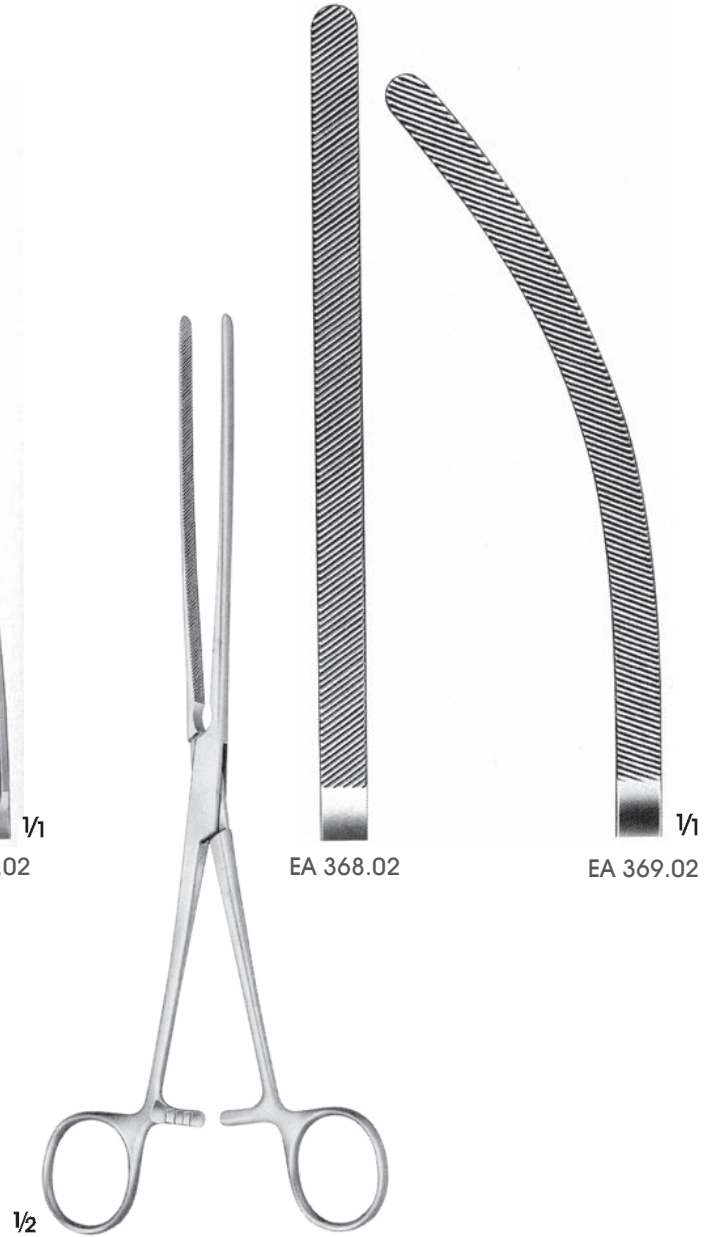

EA 368.02

EA 369.02

1/2

DOYEN
EA 368.02-EA 369.02
Yumuşak ve elastik Soft
and elastic
23.5 cm



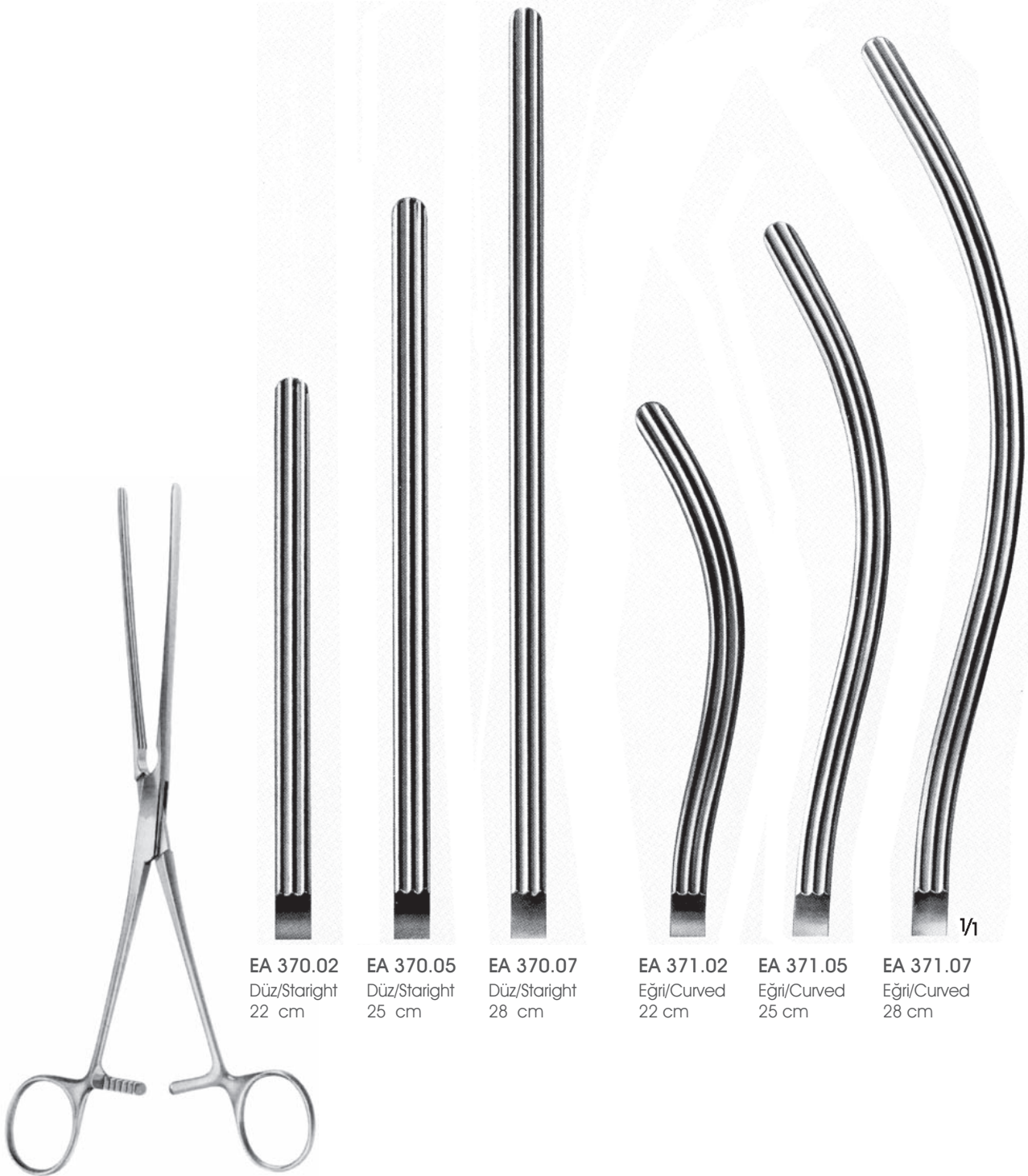

EA 370.02
Düz/Straight
22 cm

EA 370.05
Düz/Straight
25 cm

EA 370.07
Düz/Straight
28 cm

EA 371.02
Eğri/Curved
22 cm

EA 371.05
Eğri/Curved
25 cm

EA 371.07
Eğri/Curved
28 cm

KOCHER
EA 370.02-EA 370.07
EA 371.02-EA 371.07
Yumuşak ve elastik Soft and
elastic



KOCHER
EA 360.02-EA 360.07
EA 361.02-EA 361.07
Yumuşak ve elastik Soft
and elastic



EA 360.02
Düz/Straight
22 cm

EA 360.05
Düz/Straight
25 cm

EA 360.07
Düz/Straight
28 cm

EA 361.02
Eğri/Curved
22 cm

EA 361.05
Eğri/Curved
25 cm

EA 361.07
Eğri/Curved
28 cm

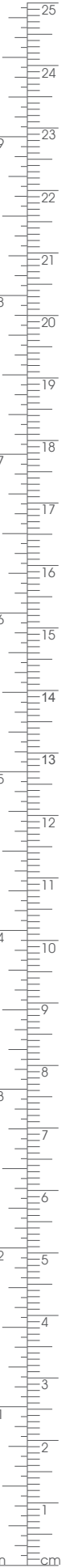

Atromatik
Atraumatic

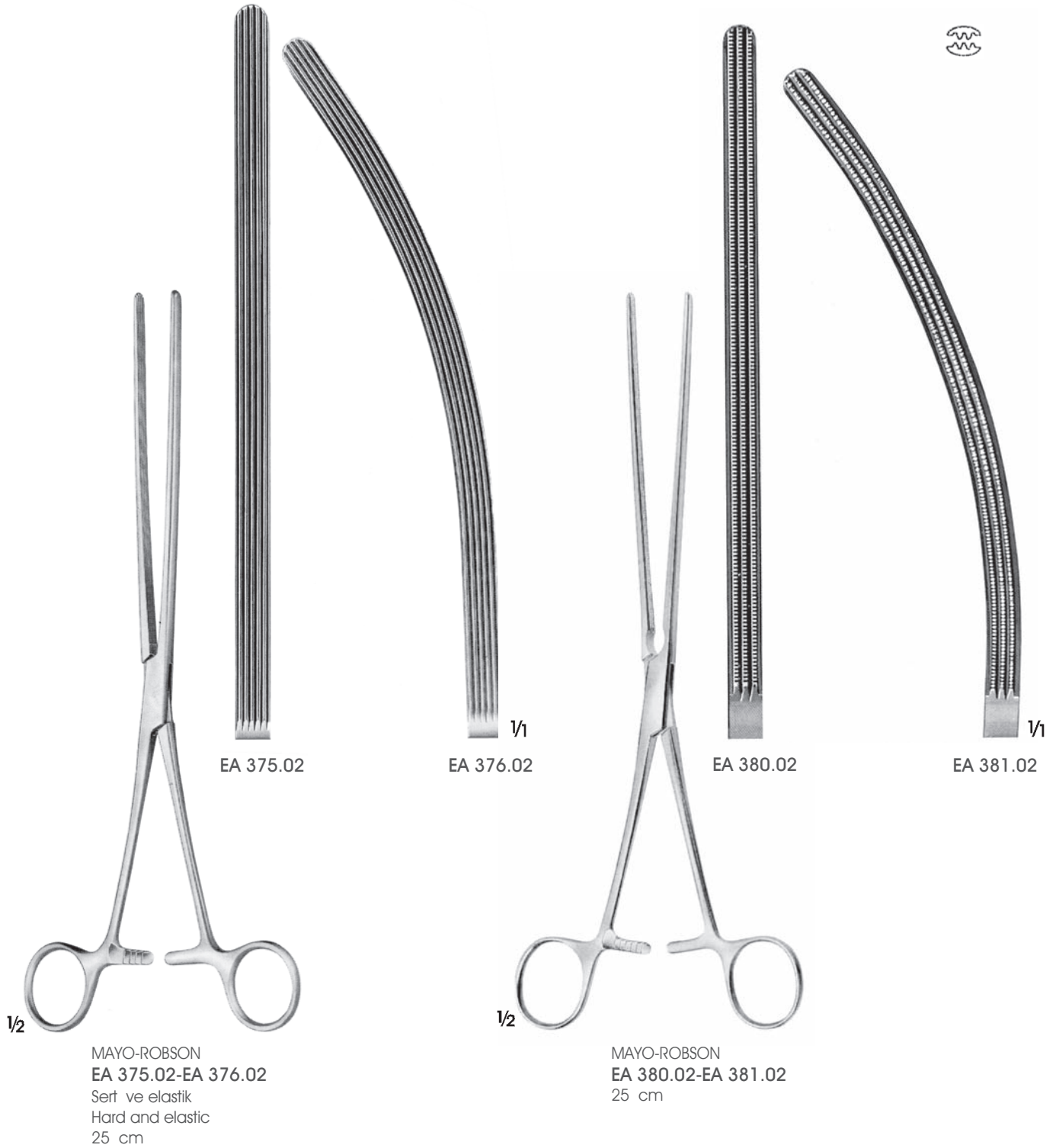

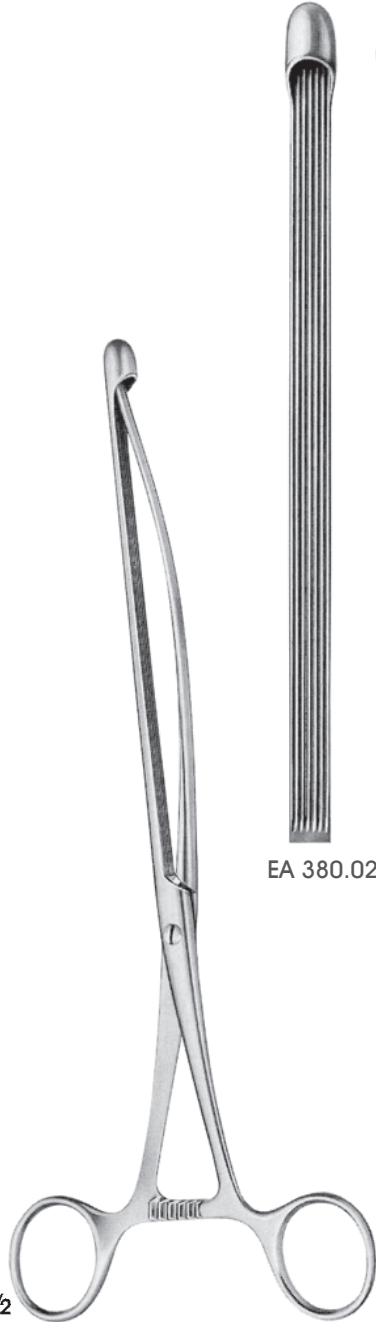

EA 380.02

EA 381.02

1/2

NUSSBAUM
EA 380.02-EA 381.02
Yumuşak ve elastik Soft and
elastic
25 cm

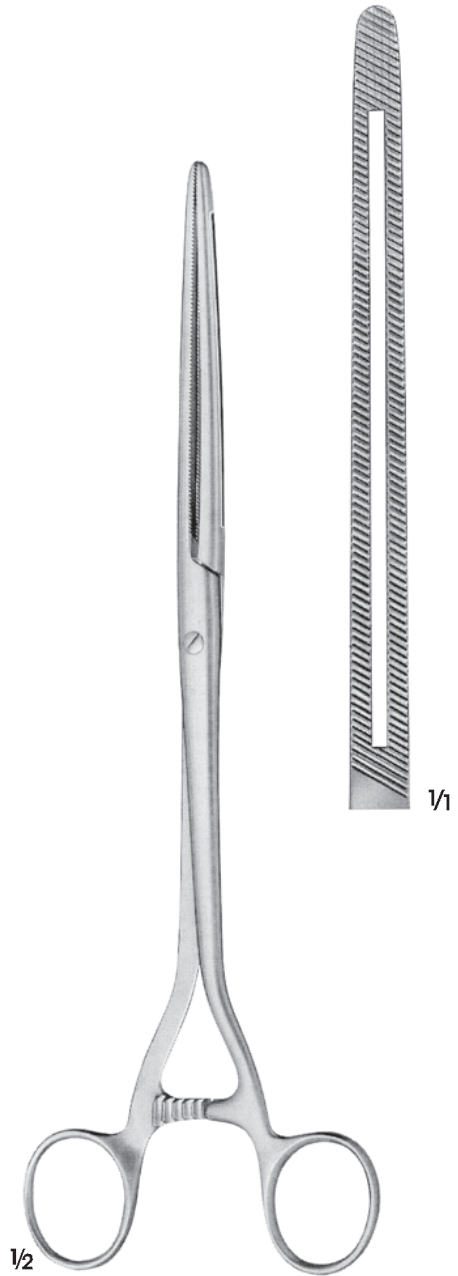

MAYNIHAN
EA 385.02
28 cm

1/2



1/2
SCHOEMAKER
EA 382.00
Kolektomi klempi
Colectomy clamp
20 cm

1/2
LANG-STEVENSON
EA 383.00
Bağırsak klempi
Intestinal clamp
20 cm

1/2
Atromatik
Atraumatic
SCUDDER
EA 385.02
Mide klempi
Stomach clamp
33 cm



PAYR
EA 580.00
Çocuklar için bağırsak klempli
Intestinal clamp light pattern,
for children
18 cm

PAYR
EA 580.02
20 cm

PAYR
EA 580.04
27.5 cm

PAYR
EA 580.06
Pilor Klempli
Pylorus clamp
31.5 cm



Atromatik
Atraumatic

Mide-Bağırsak Pensleri, İkili
Gastro-Intestinal Forceps, Twin

 ARGENT



1/2

HABERER
EA 484.02
36 cm



1/1





BENSON
EA 398.00
Pilor ayırıcı
Pylorus spreader
15.5 cm



KLEINSCHMIDT
EA 350.00
Apendektomi klem
Appendectomy clamp
13 cm



DE MARTEL-WOLFSON
EA 585.00 10 cm
EA 585.01 12 cm
Anastomoz klem, 3'lü set
Anastomosis clamps,
set of 3



EA 587.23 22.5 cm
Klem tutucusu
Clamp holder
(EA 585.00-EA 585.01)



Sert Klem tutucu
Clamp holder with set of clamps

EA 587.08 8 cm
Klem tutucusu
Clamp holder
(EA 585.00-EA 585.01)



1/3
DE MARTEL-WOLFSON
EA 589.00 Kapama
pensi Closing forceps
(EA 585.00-EA 585.01)
25 cm

Atromatik
Atraumatic



FB 200.00
78 mm

FB 200.01
88 mm

FB 200.02
98 mm

1/1

1/1



DICK
FB 200.00 25.5 cm
FB 200.01 26.5 cm
FB 200.02 27.5 cm
Güçlü klempler
Pressure clamps

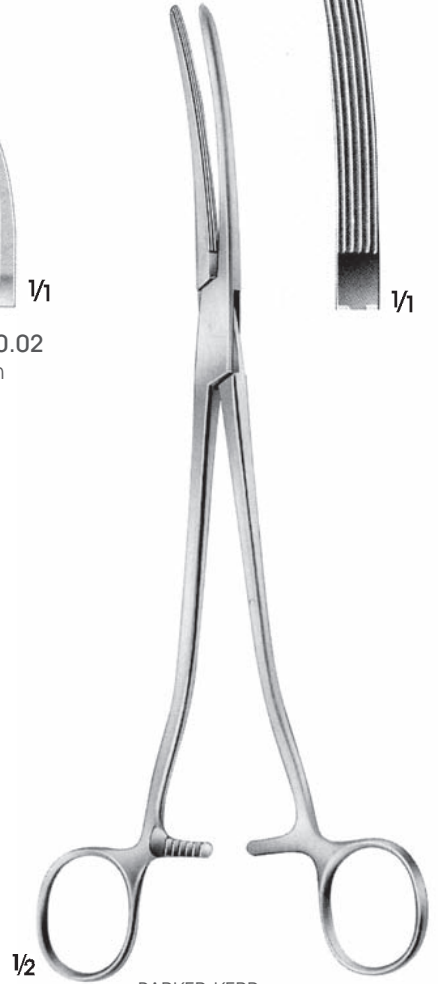

1/2

PARKER-KERR
FB 463.02
Anastomoz pensisi, kolon
rezeksiyonu için
Anastomosis forceps for
colon resection
25 cm

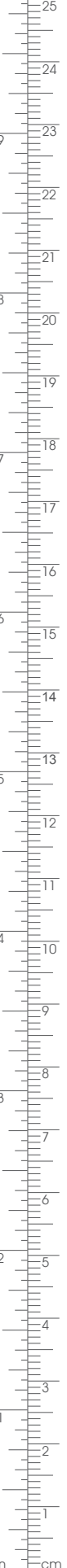

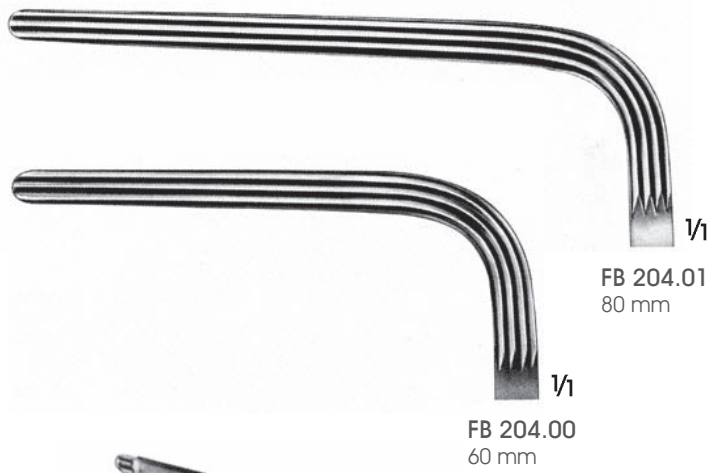

FB 204.00-FB 204.01
23 cm

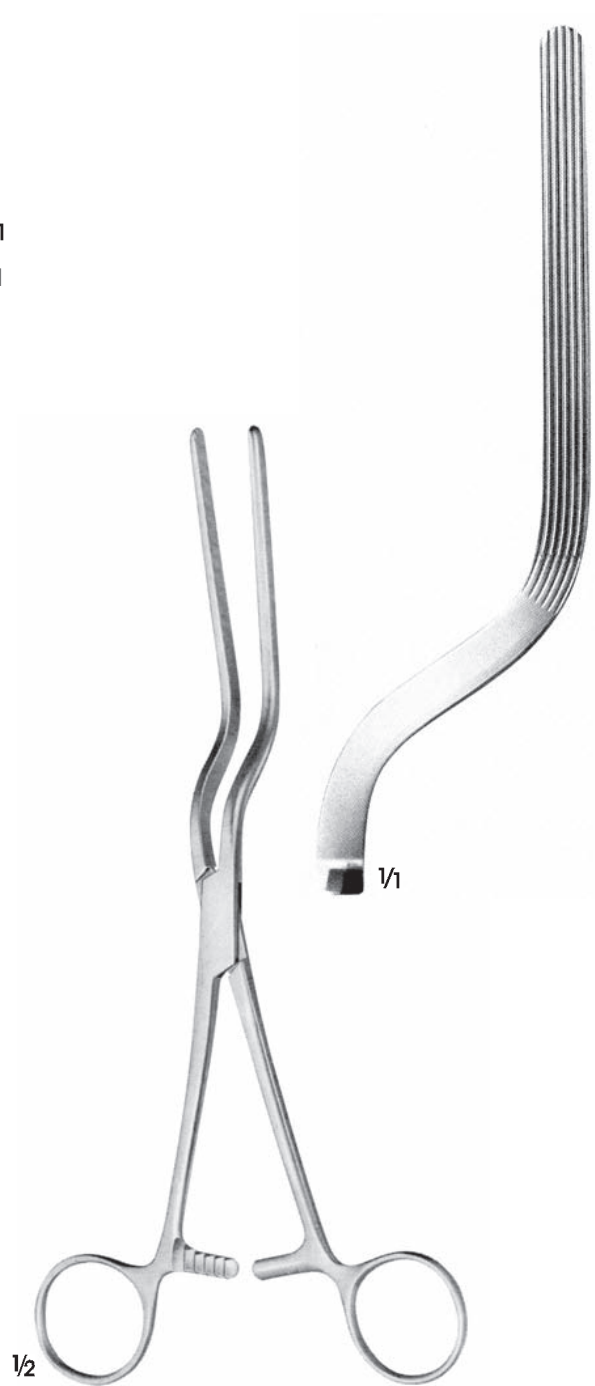



LLOYD-DAVIS
EA 490.02
31.5 cm

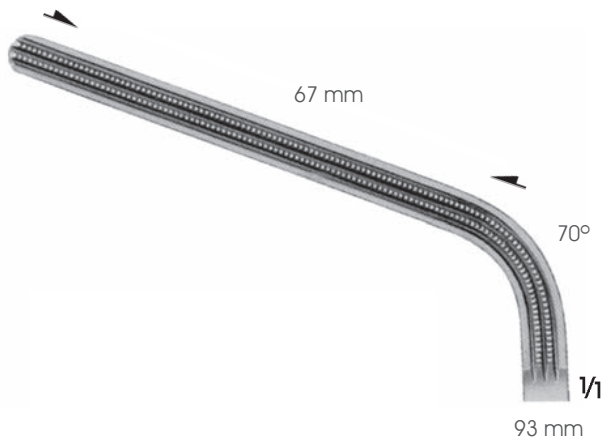

MORRIS
FB 460.00
17.5 cm

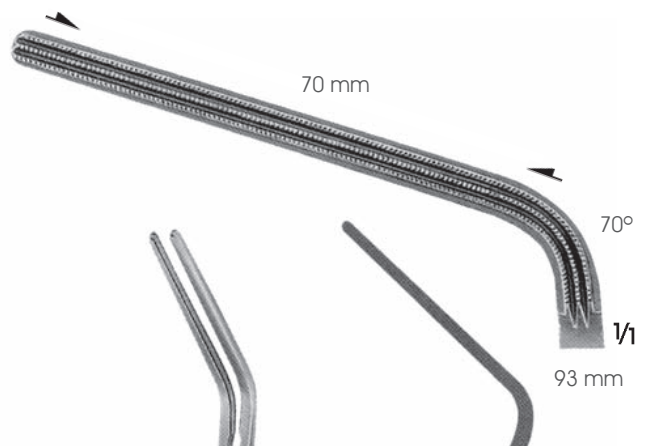

DE BAKEY (MORRIS)
FB 461.00
24 cm

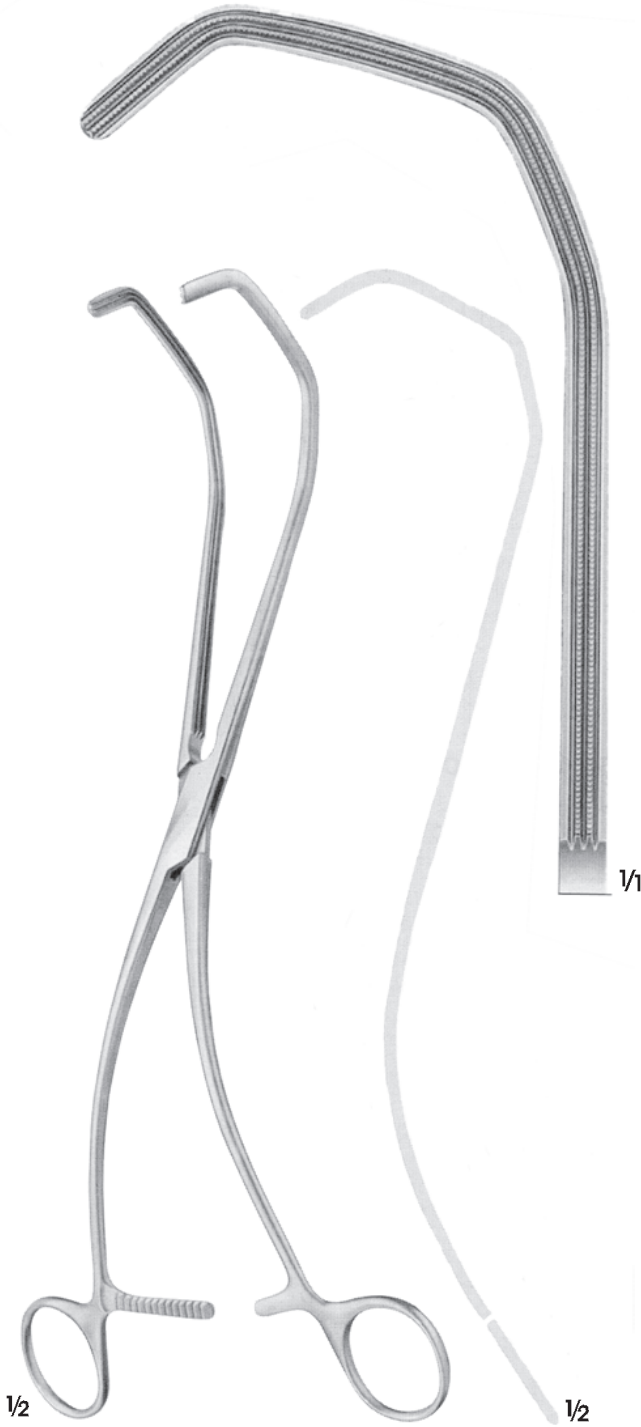
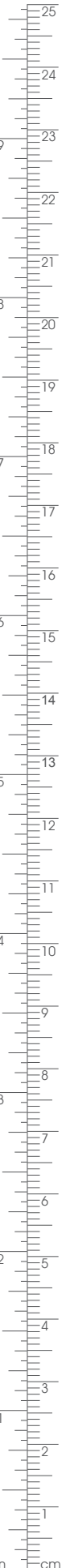

KERSTING
EA 375.03
30 cm



RESONE
EA 377.03
Yumuşak/Elastic
26.5 cm

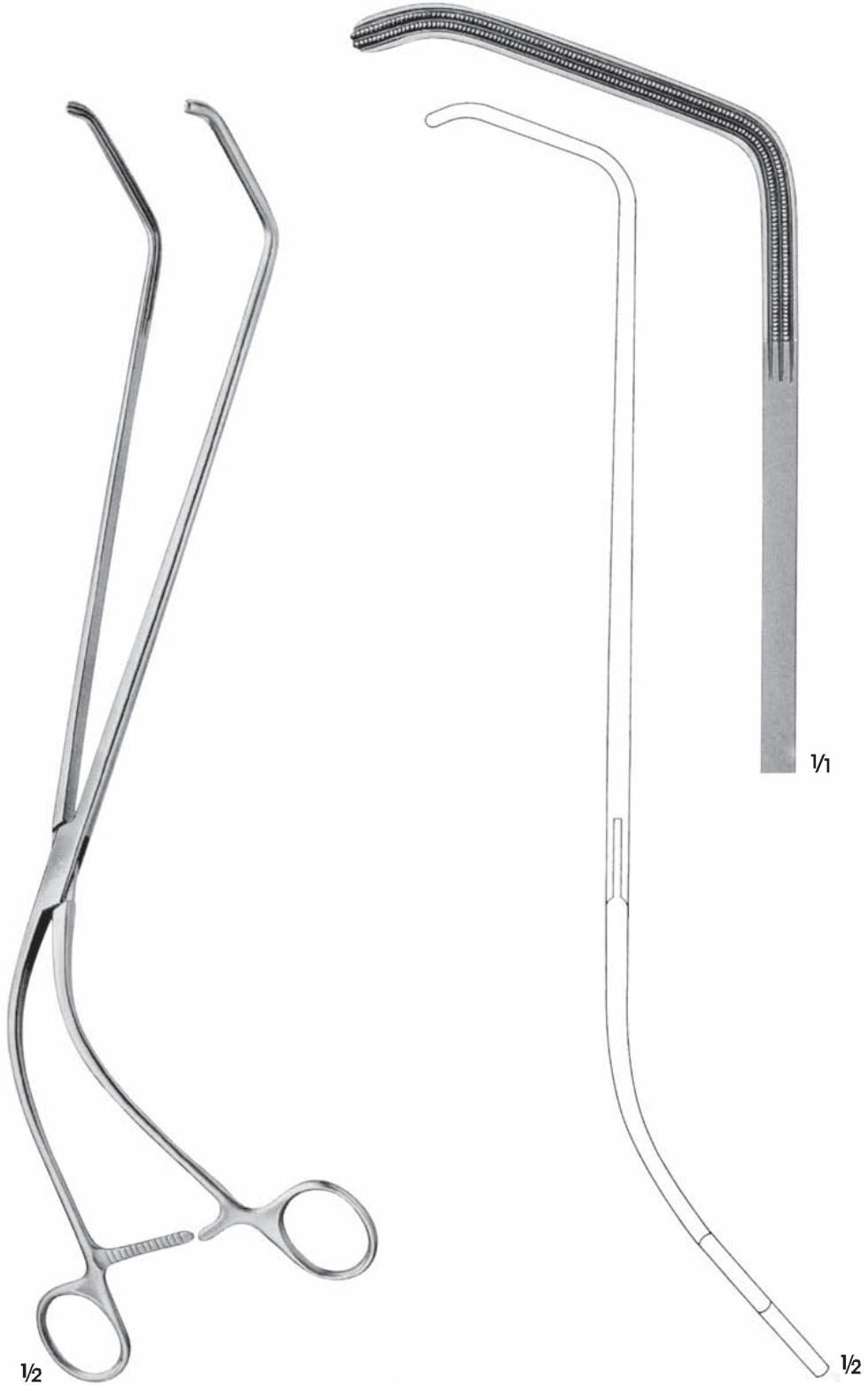

MULLER
EA 378.00
Rektal anastomoz klem
Rectal anastomosis clamp
37.5 cm

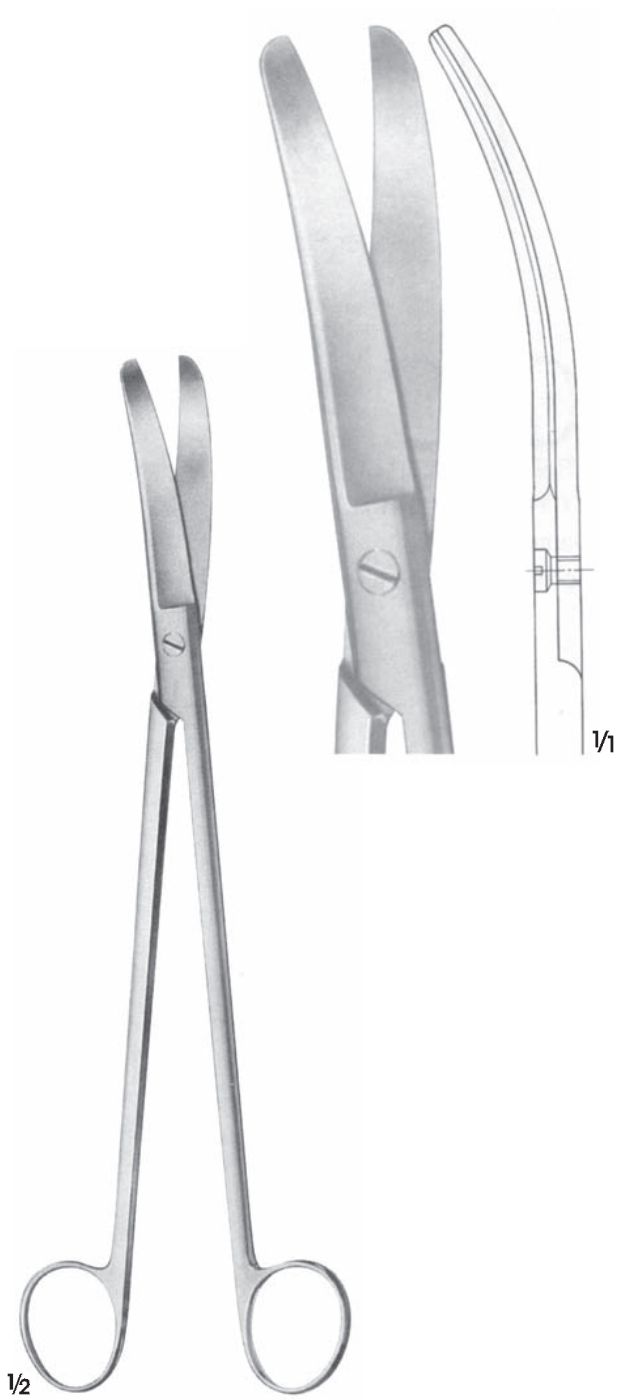

LLOYD-DAVIES (GOLIGHER'S)
BC 571.04
27 cm

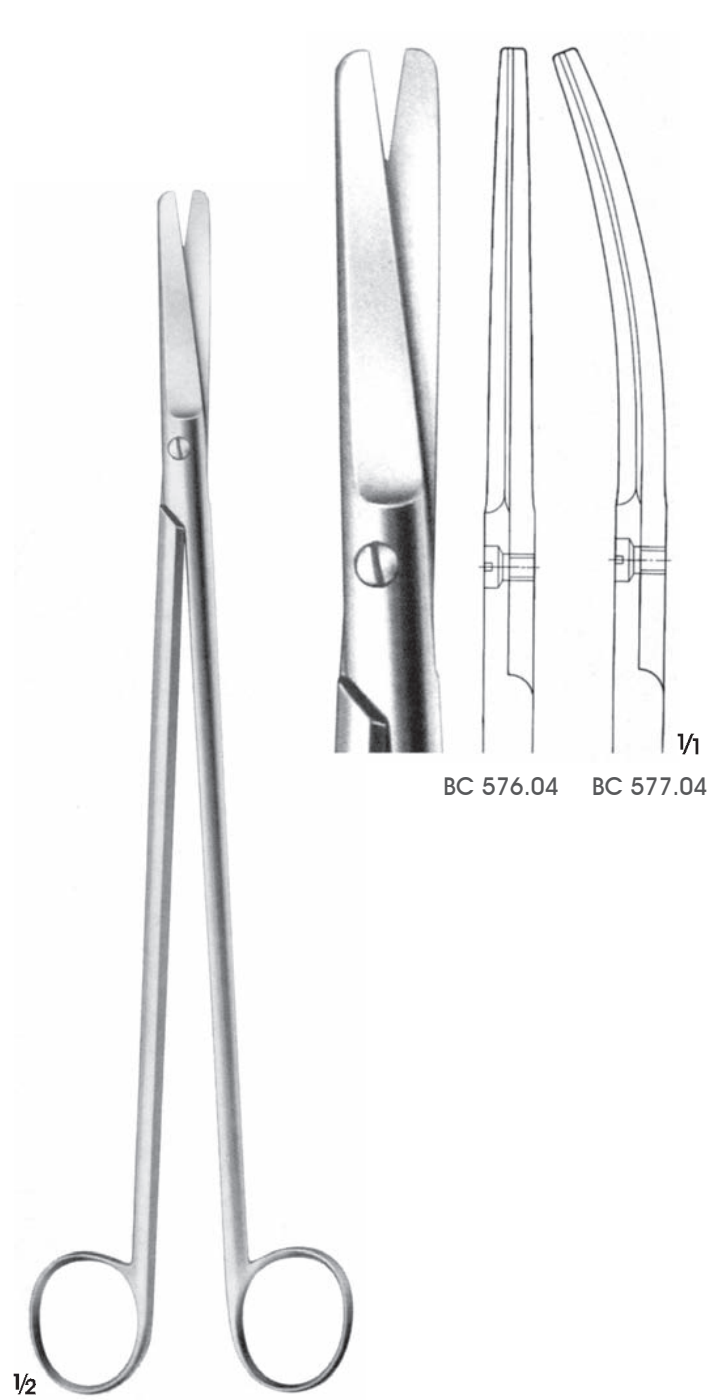

STELZNER
BC 576.04-BC 577.04
31 cm

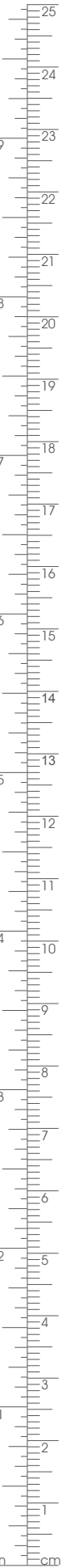

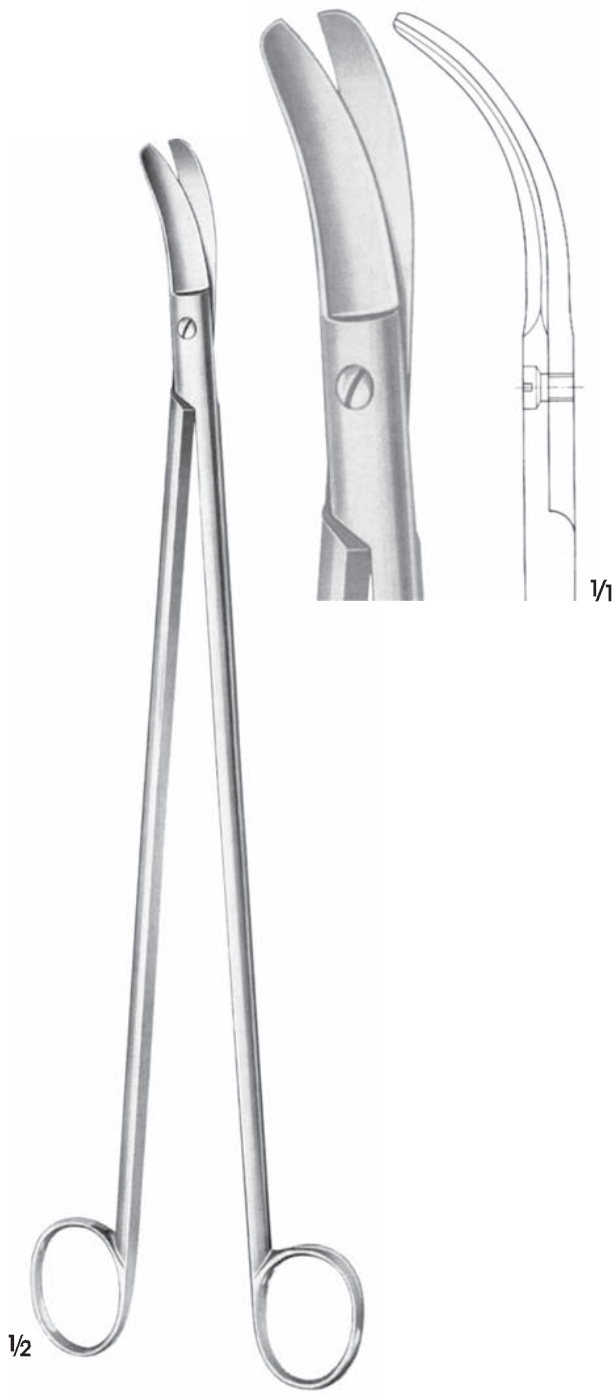

BC 579.04
Rektal makas
Rectal scissors
32.5 cm

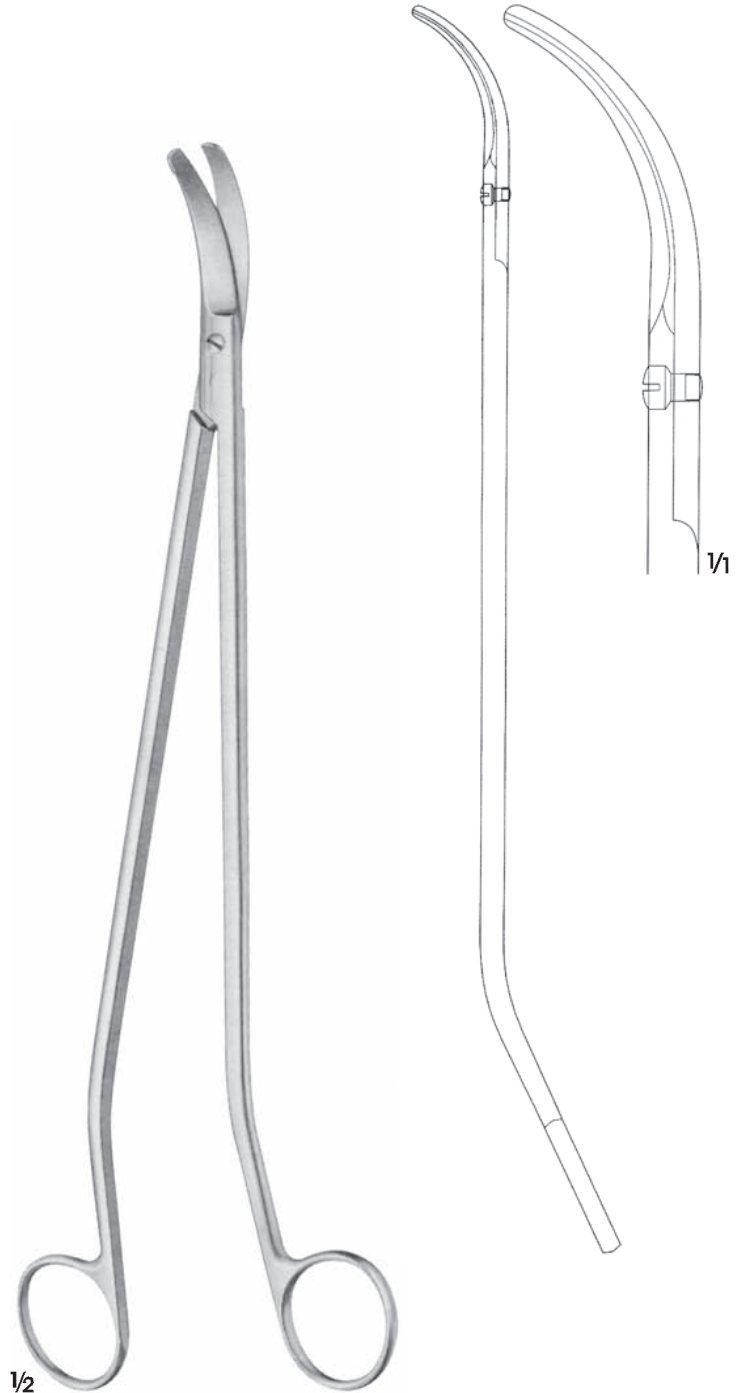

MÜLLER
BC 578.00
Rektum makas s şekli
Rectum scissors s-shaped
32.5 cm



ALLIS
EA 150.10
Tutma pensi
Grasping forceps
29.5 cm

Atromatik
Atraumatic



DE BAKEY
FB 266.03
35 cm



MÜLLER
BM 354.00
Portegü/Needle holder
36 cm

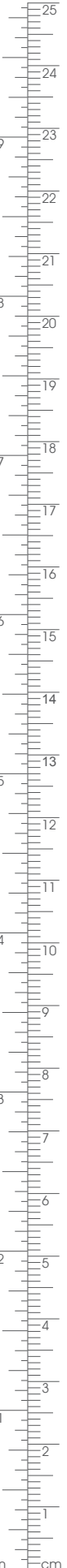

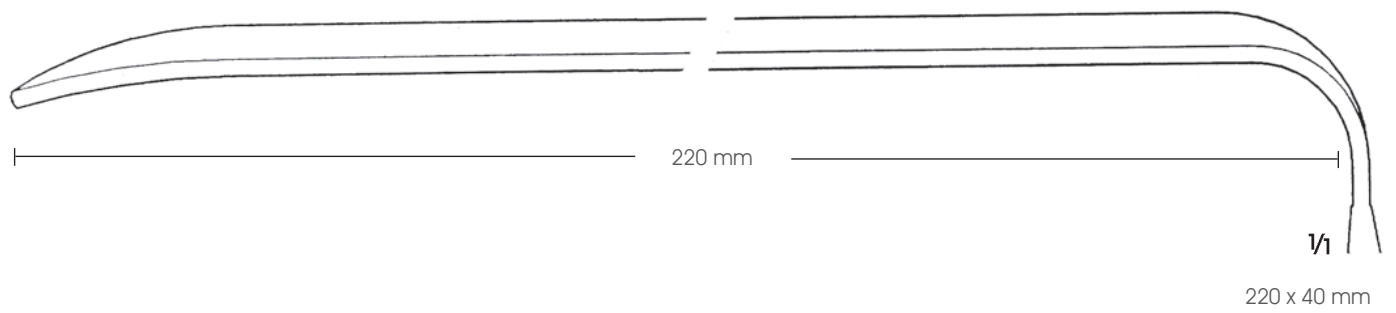

HÖSEL
BT 609.06
Ekartör /Retractor
25 cm

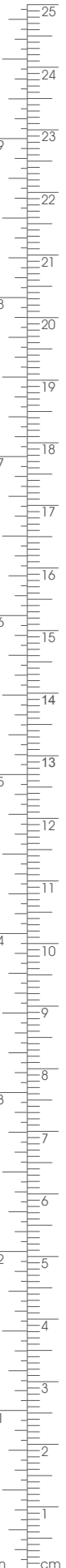
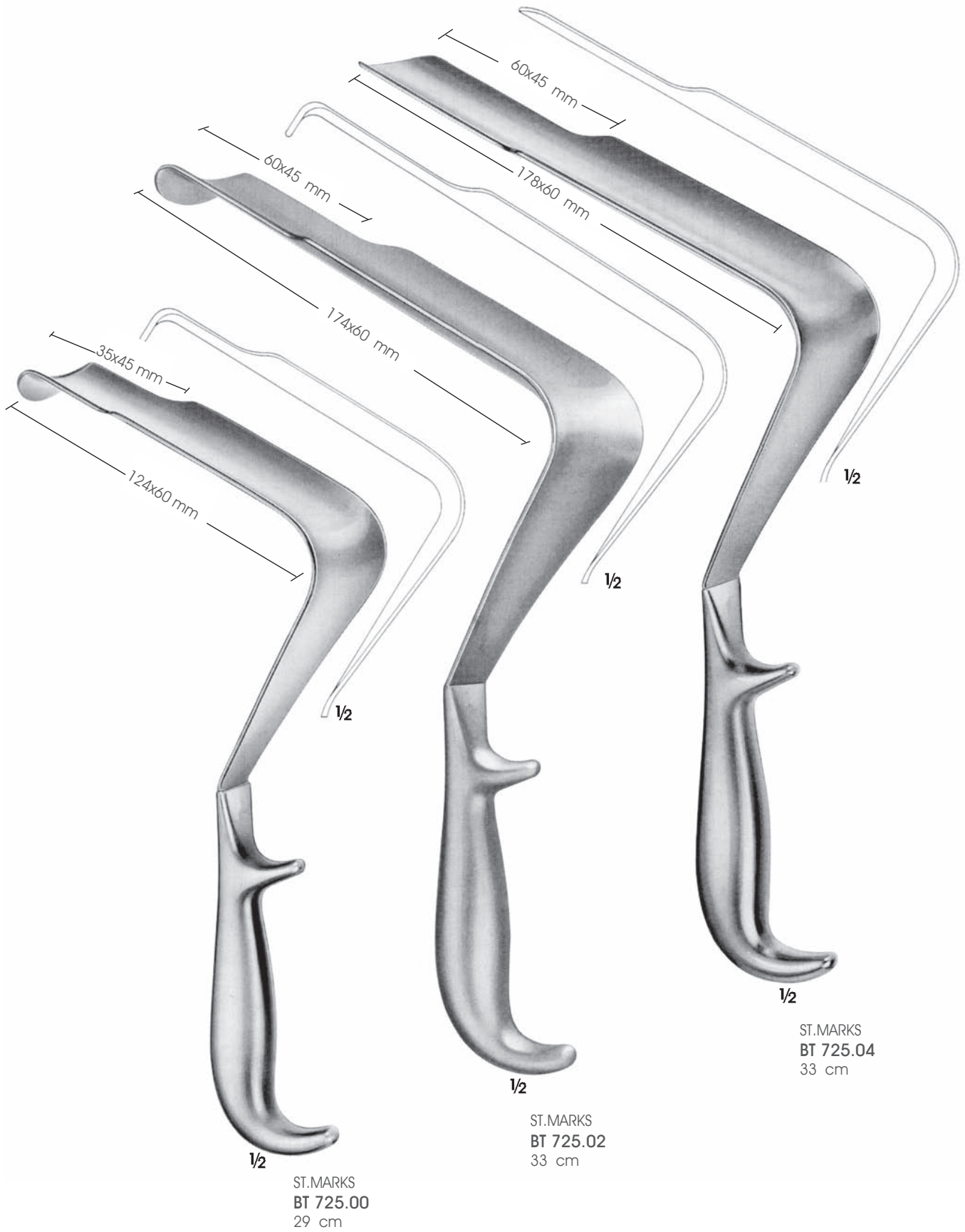

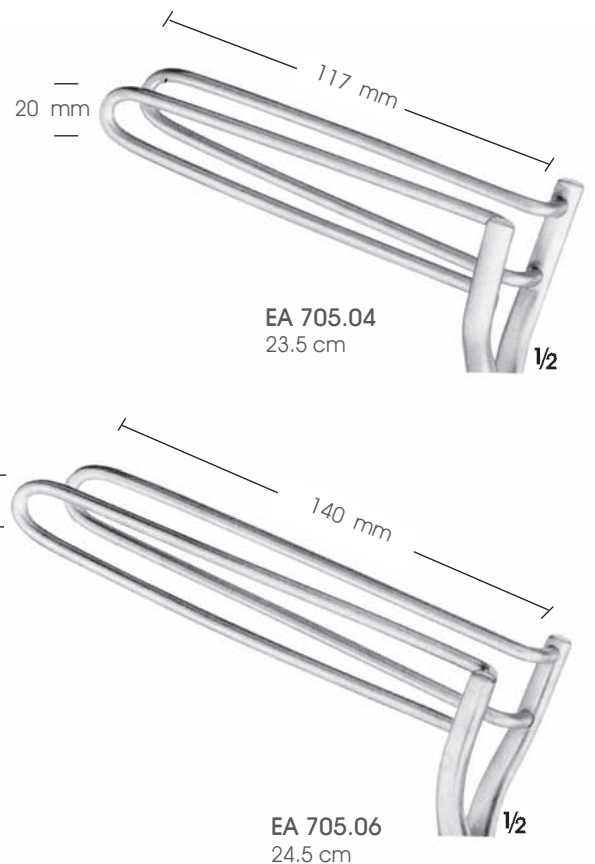
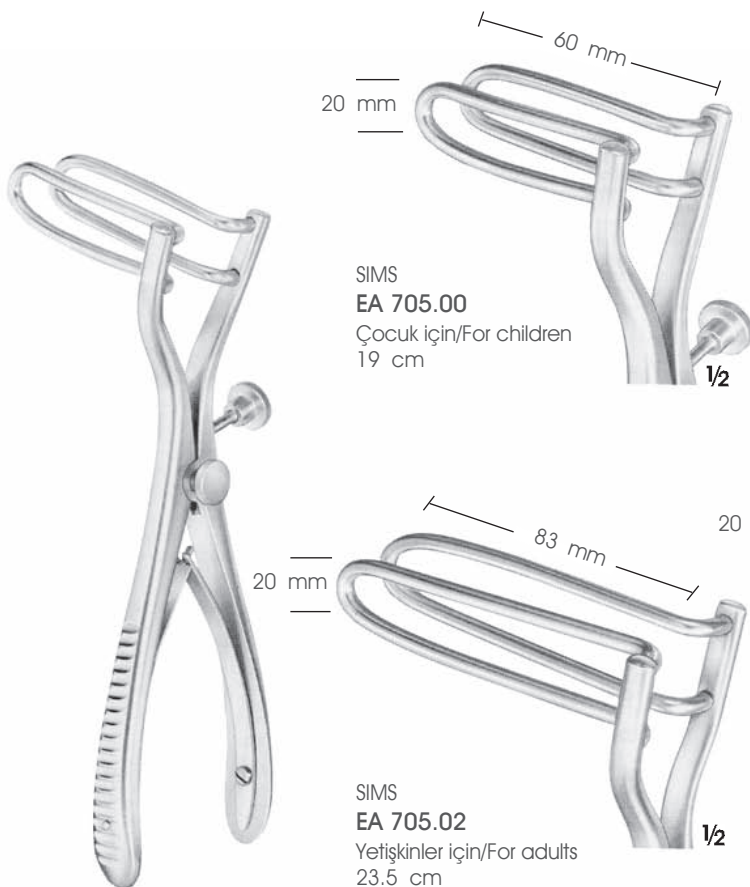
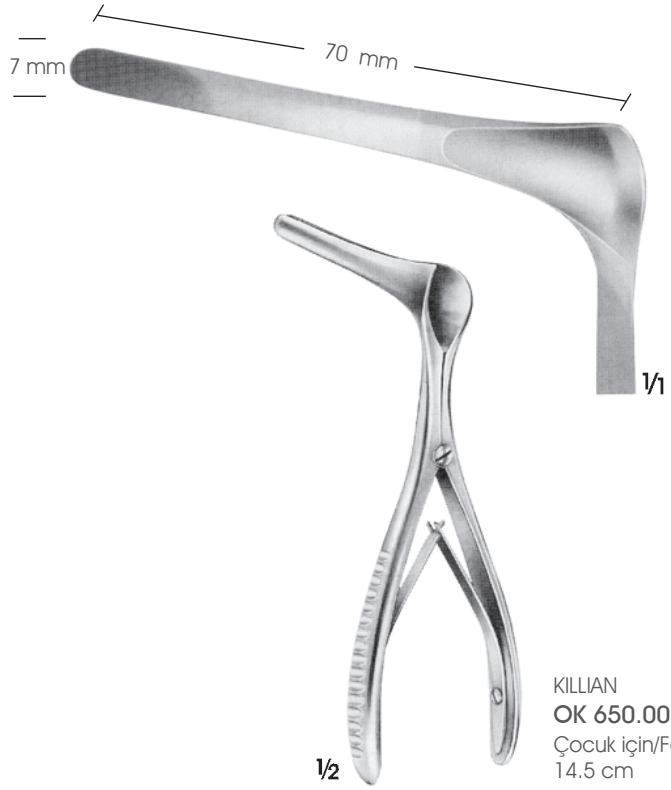



1/2
SIMS
EA 707.00
16 cm



1/2
SIMS
EA 708.00
16 cm

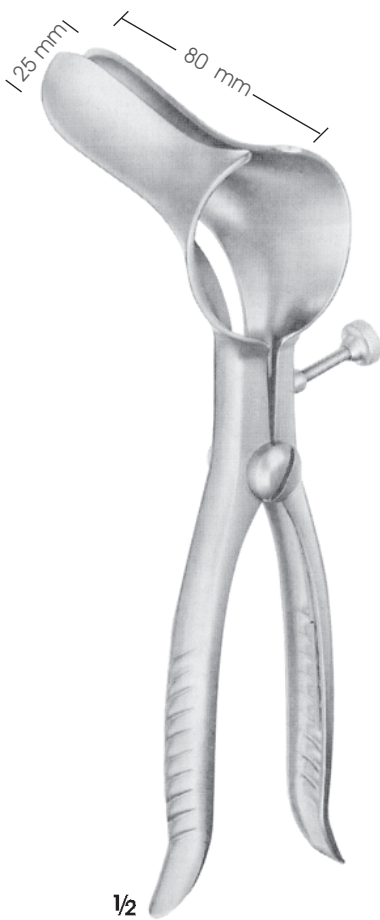

1/2
PRATT
EA 710.00
20.5 cm

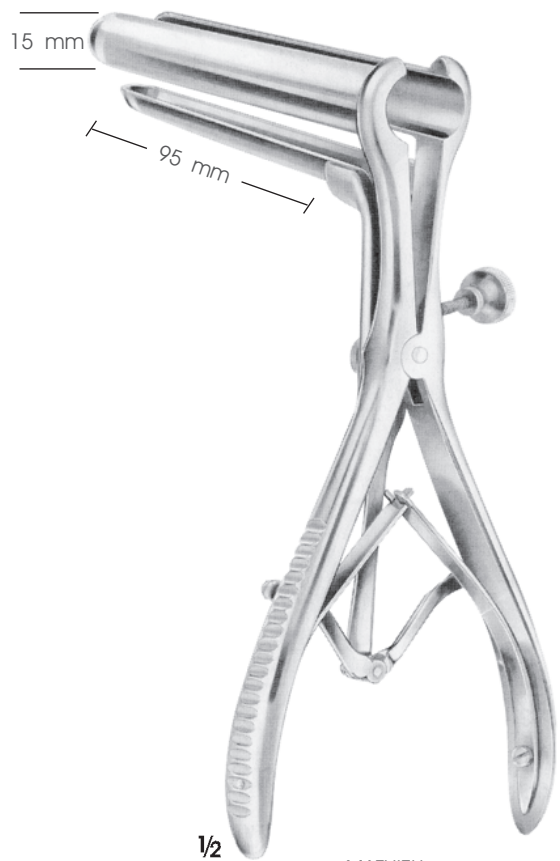

1/2
MATHIEU
EA 712.00
21.5 cm

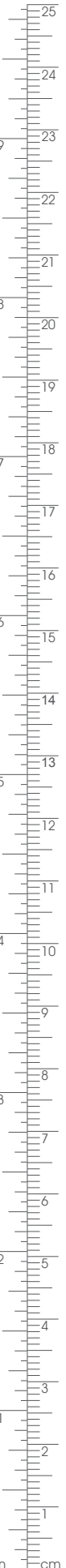



1/2
SIMS
EA 714.00
15 cm

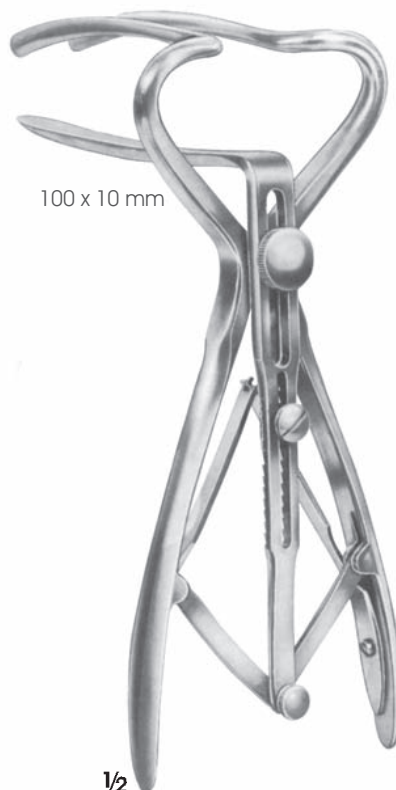

100 x 10 mm

1/2
COCK
EA 716.00
19 cm



HIRSCHMANN
EA 720.00 Ø 16 x 65 mm
EA 720.01 Ø 19 x 65 mm
EA 720.02 Ø 22 x 65 mm



KELLY
EA 721.00 Ø 22 x 50 mm
EA 721.01 Ø 22 x 100 mm
EA 721.02 Ø 22 x 140 mm



1/2
BENSAUDE
EA 725.00 Ø 17 mm
EA 725.01 Ø 20 mm
EA 725.02 Ø 23 mm
Anoskoplar/Anoscopes
18.5 cm



1/2
IVES-FANSLER
EA 728.00 Ø 24
mm Anoskop/
Anoscope 14.5 cm



1/2
KELLY
EA 730.00 Ø 20 mm
Anoskop/Anoscope 16
cm



1/2
KELLY
EA 730.01 Ø 25 mm
Sfinteroskop/Sphincteroscope
16 cm

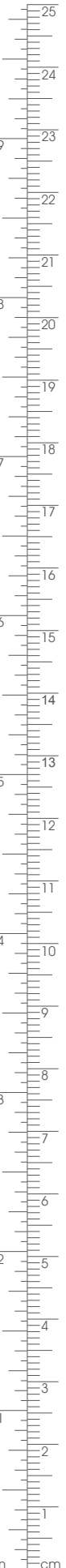

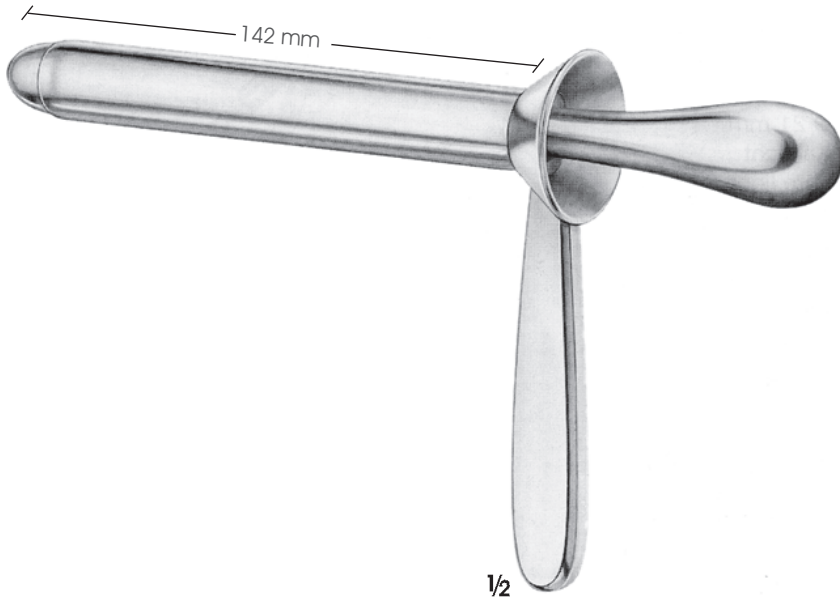

1/2
 KELY
EA 732.00
 Proktoskop
 Proctoscope
 14 cm



1/1
EA 738.10
 ACM İngiliz standardı fiber ışık taşıyıcı
 Fibre light attachment,
 ACM/British standard
 for NAUNTON-MORGAN specula

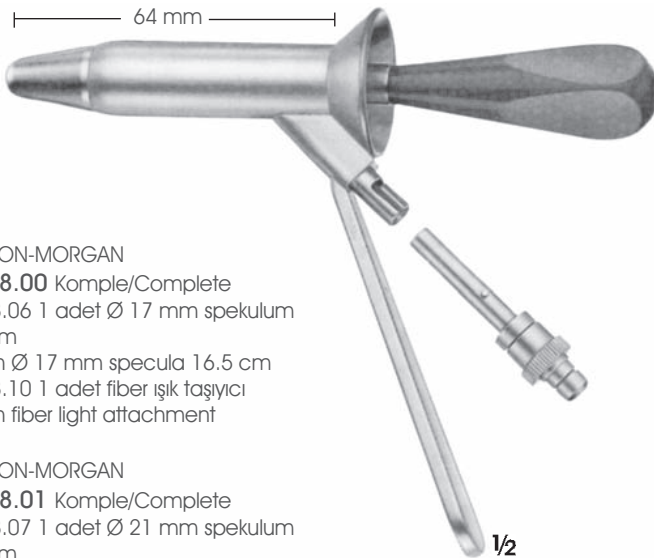

NAUNTON-MORGAN
EA 738.00 Komple/Complete
 EA 738.06 1 adet Ø 17 mm spekulum
 16.5 cm
 1 each Ø 17 mm specula 16.5 cm
 EA 738.10 1 adet fiber ışık taşıyıcı
 1 each fiber light attachment

NAUNTON-MORGAN
EA 738.01 Komple/Complete
 EA 738.07 1 adet Ø 21 mm spekulum
 16.5 cm
 1 each, Ø 21 mm specula 16.5 cm
 EA 738.10 1 adet fiber ışık taşıyıcı
 1 each fiber light attachment

NAUNTON-MORGAN
EA 738.01 Komple/Complete
 EA 738.08 1 adet Ø 24 mm
 spekulum 16.5 cm
 1 each Ø 24 mm specula 16.5 cm
 EA 738.10 1 adet fiber ışık taşıyıcı
 1 each fiber light attachment

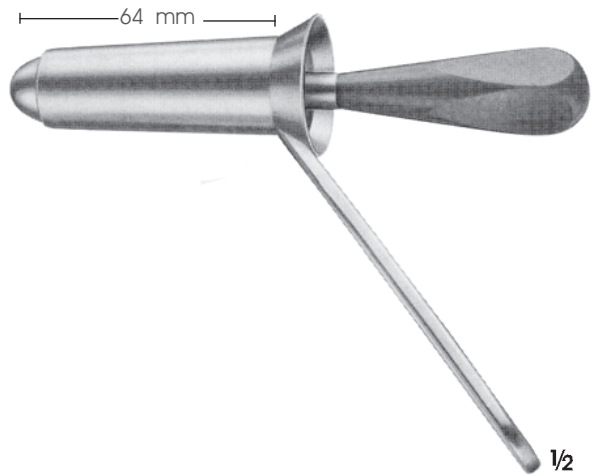

GABRIEL
EA 736.00 Ø 25
 mm Rektal spekulum
 Rectal speculum

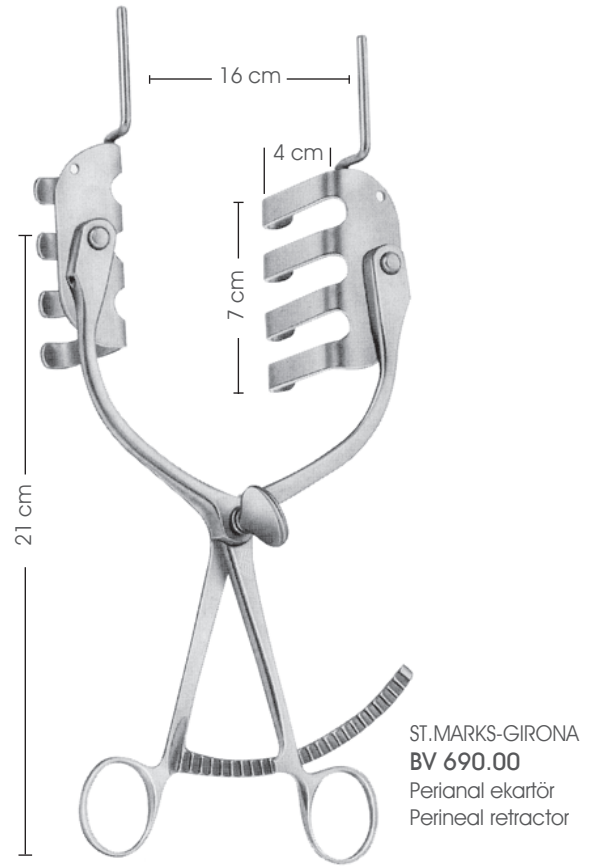
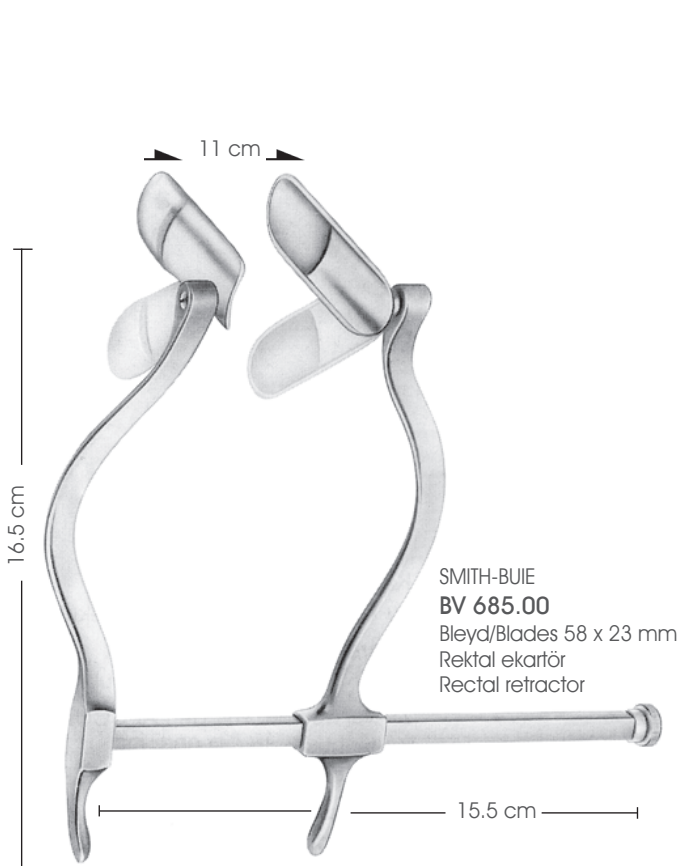
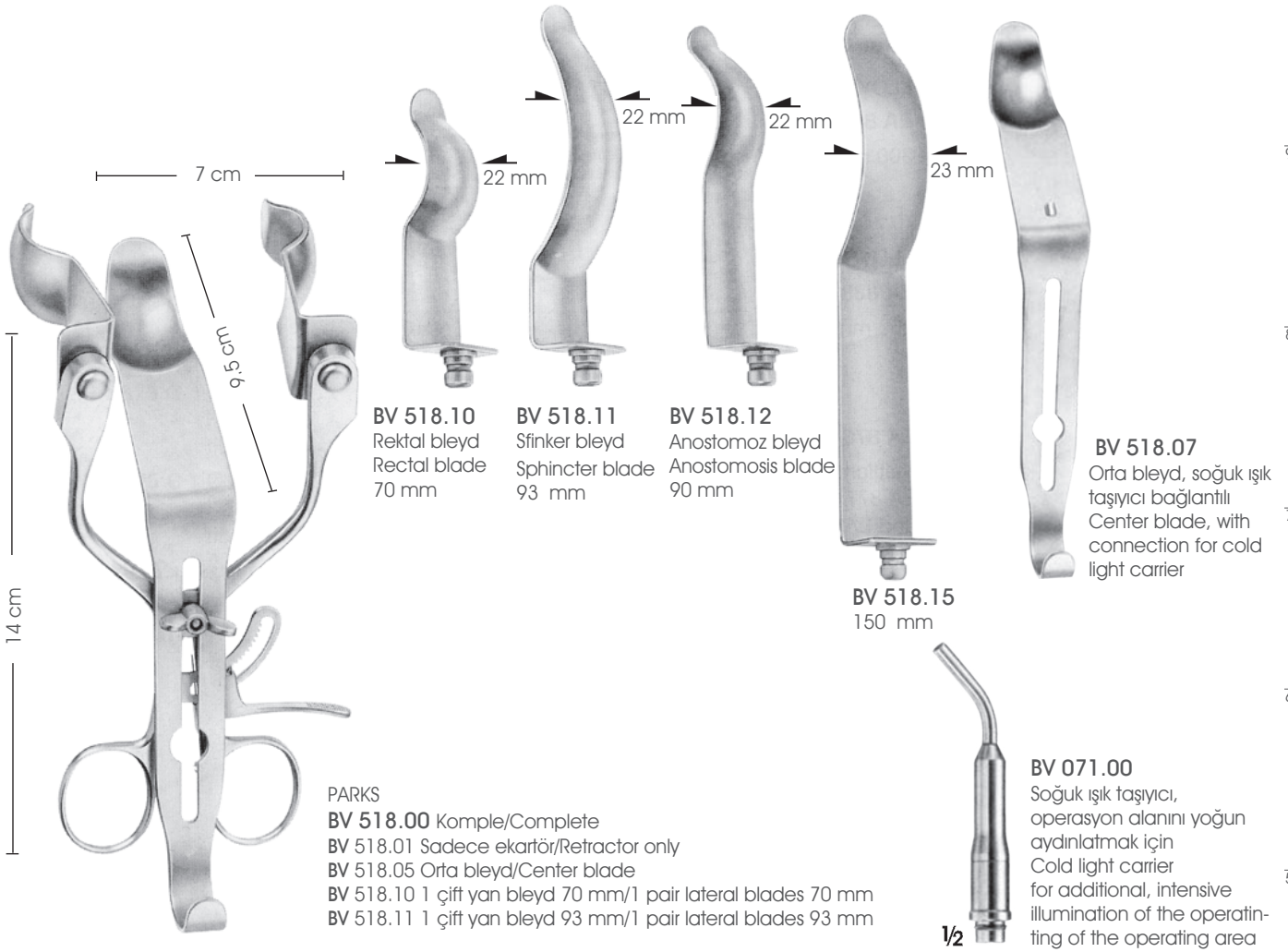

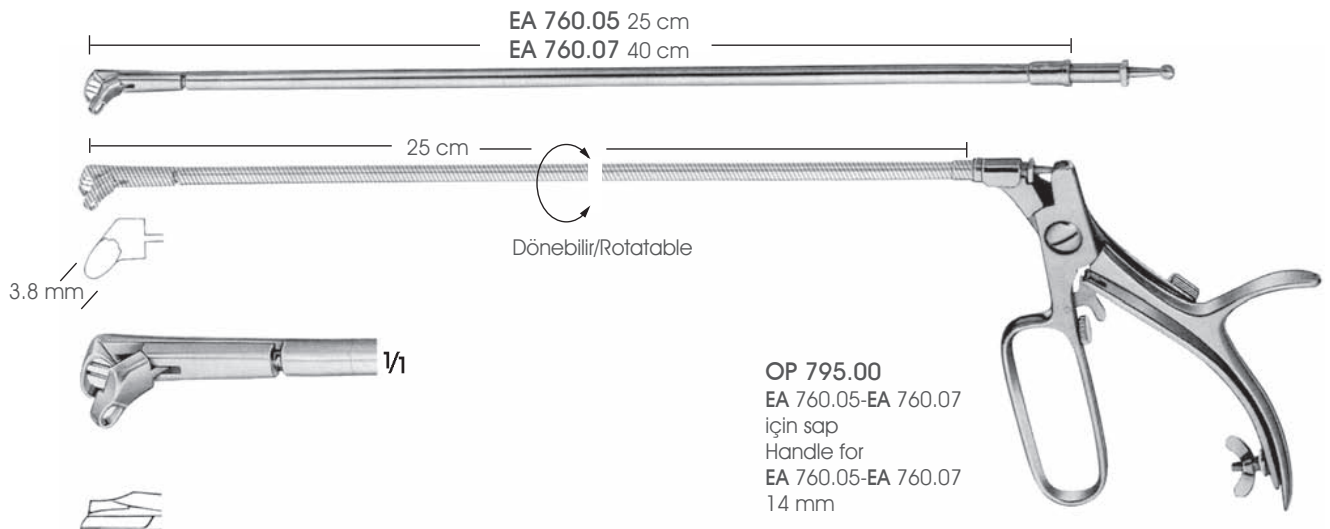
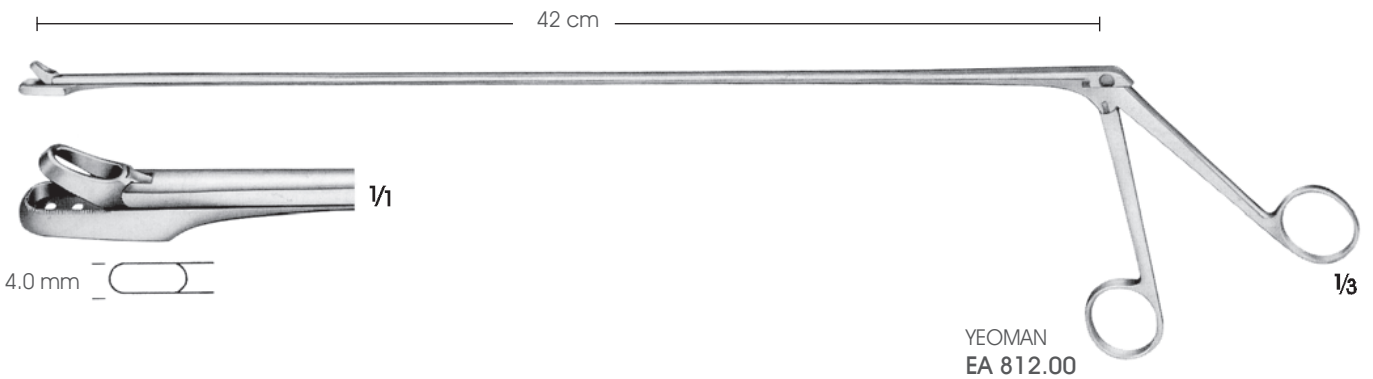
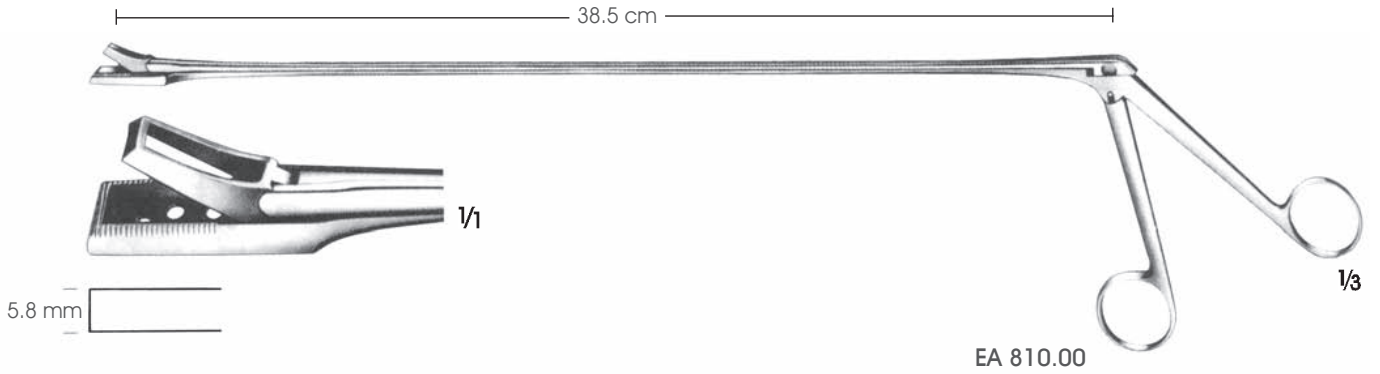
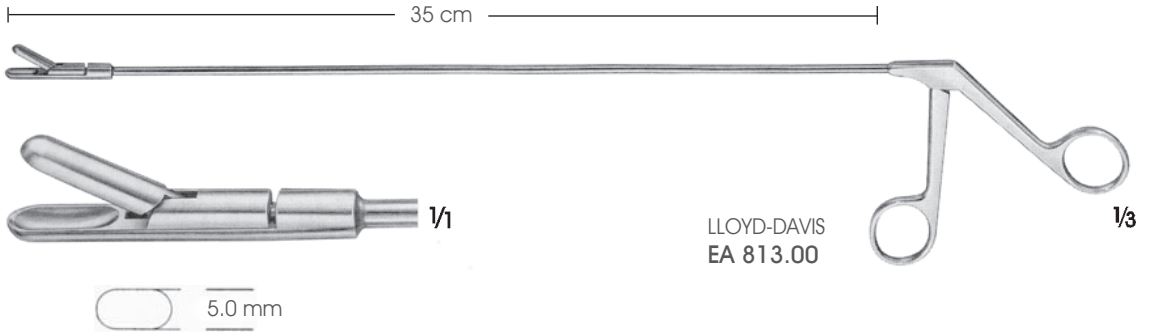

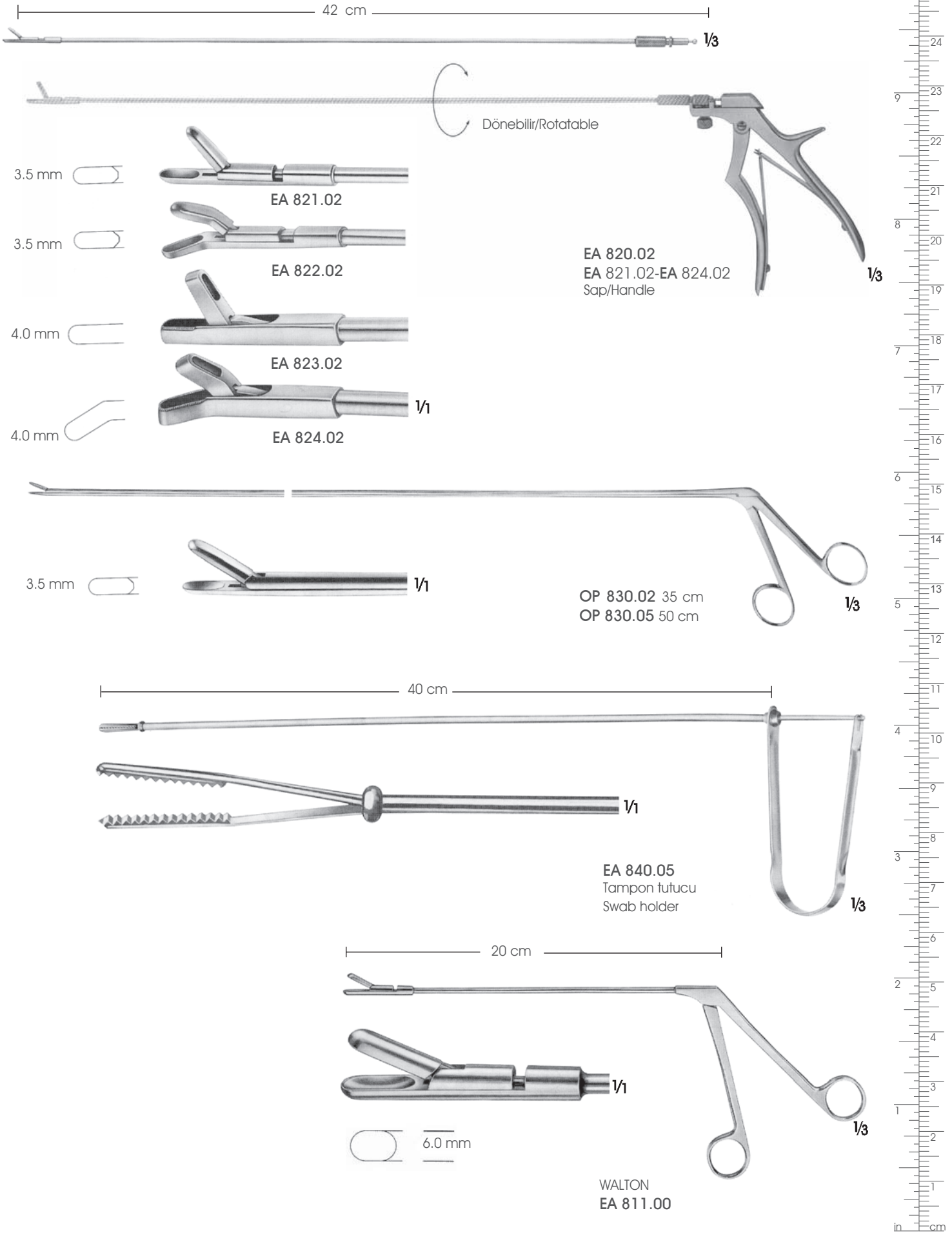

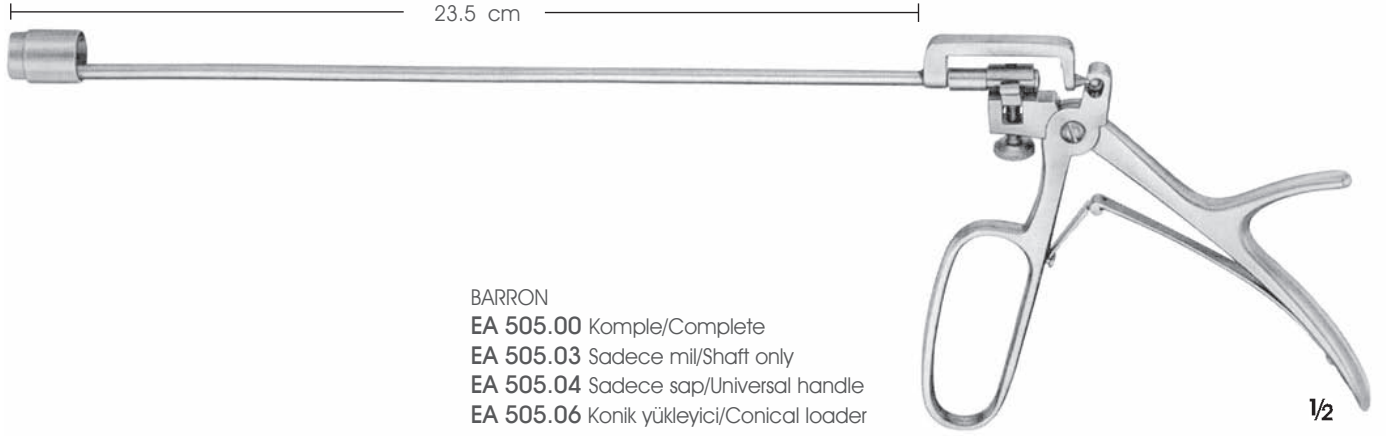

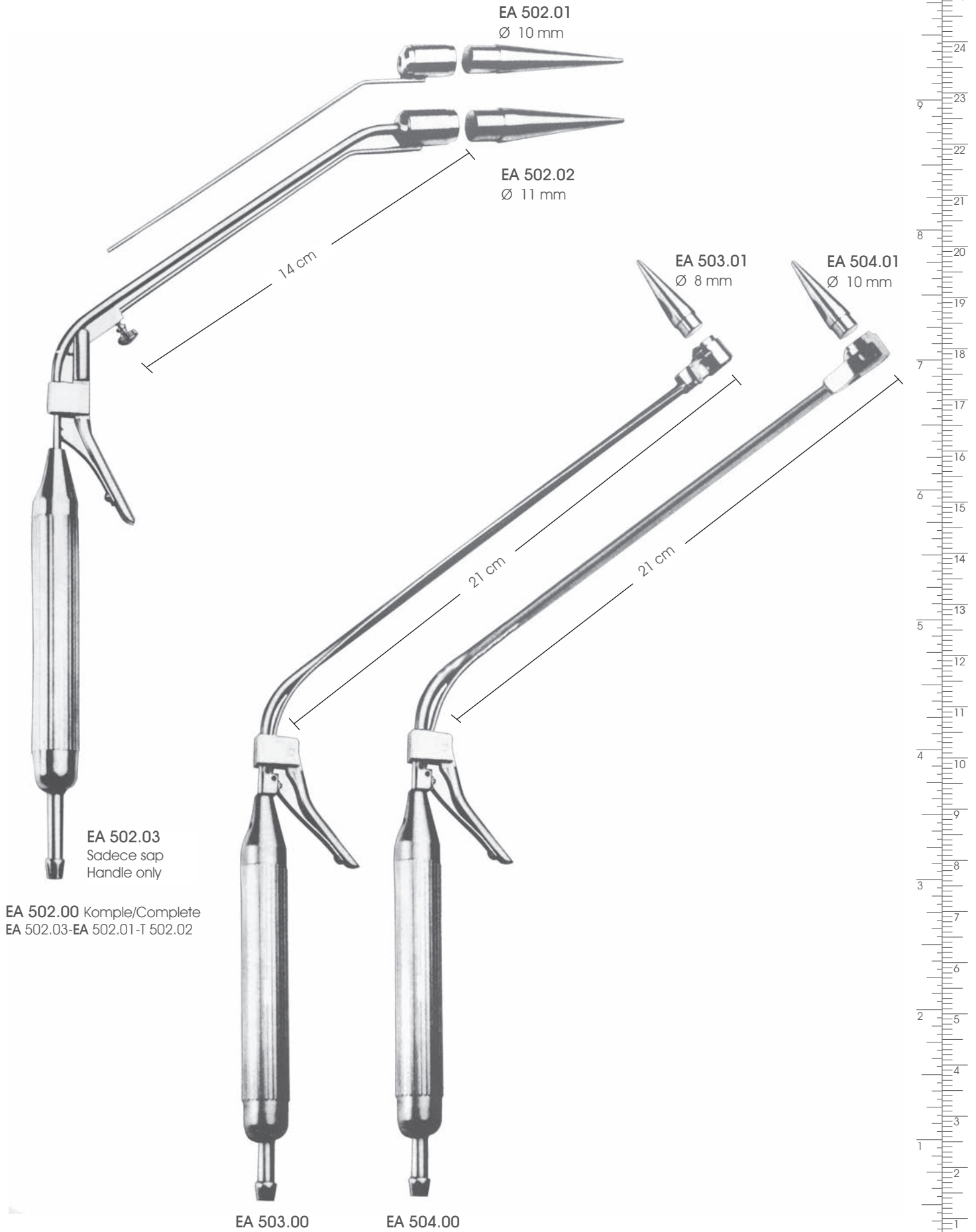

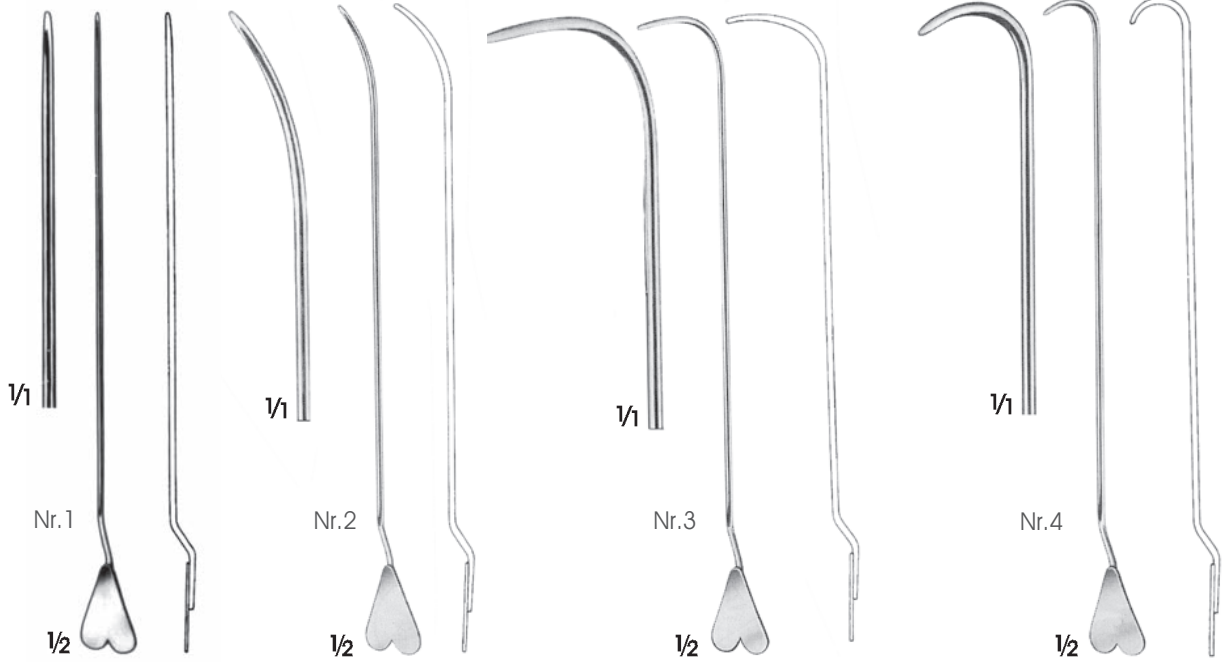

LOCKHART-MUMMERY

Fistül sonda/Fistula probes

BN 020.00 Nr.1 Düz/Straight

BN 020.01 Nr.2 45° Eğri/Curved

BN 020.02 Nr.3 90° Eğri/Curved

BN 020.03 Nr.4 Geriye doğru eğri/Curved

retrograde 16.5 cm

Ø 3.5 mm

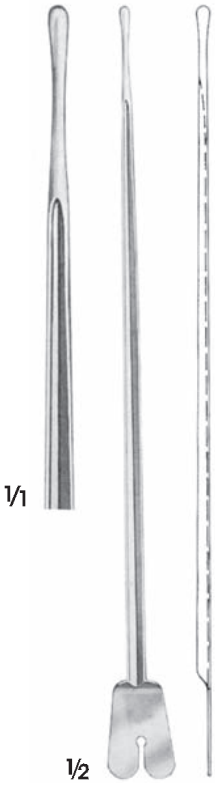

BIRODIE
BN 018.00
20 cm



BN 024.00
Bükülebilir/Malleable
19 cm

Ø 3 mm



BN 037.00
Çift delikli ve uçlu
bükülebilir sonda
Double ended probe,
malleable, with hole
19 cm



BT 227.00
Fistül sonda
Fistula probe
24 cm

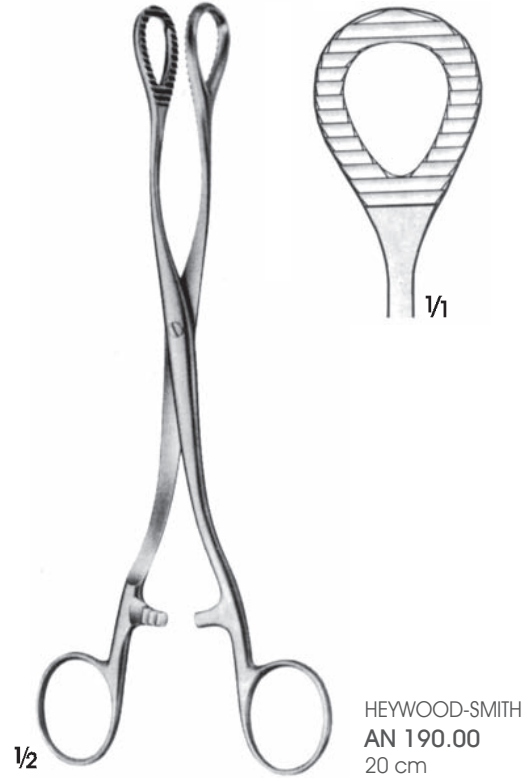
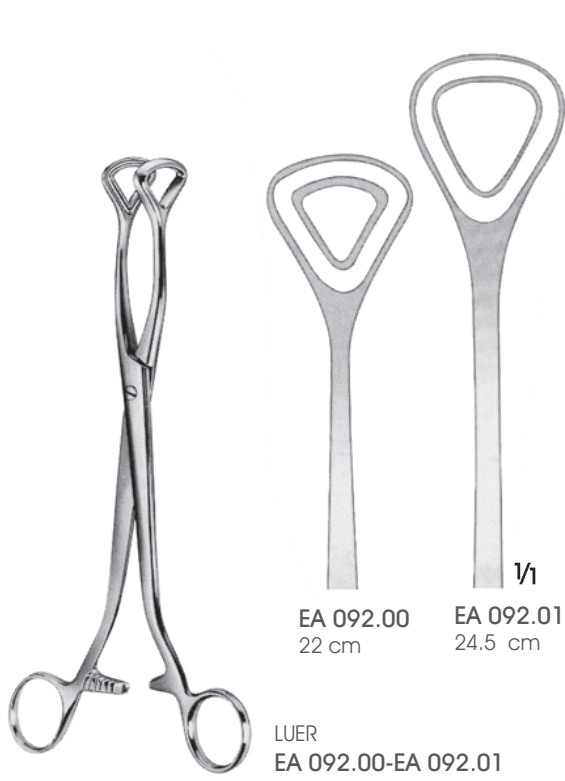

 Atraumatik
Atraumatic

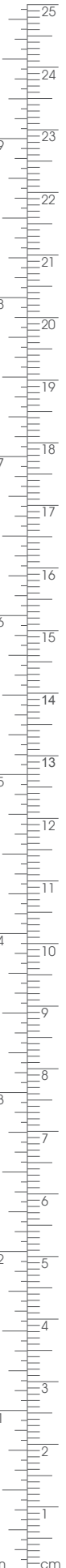
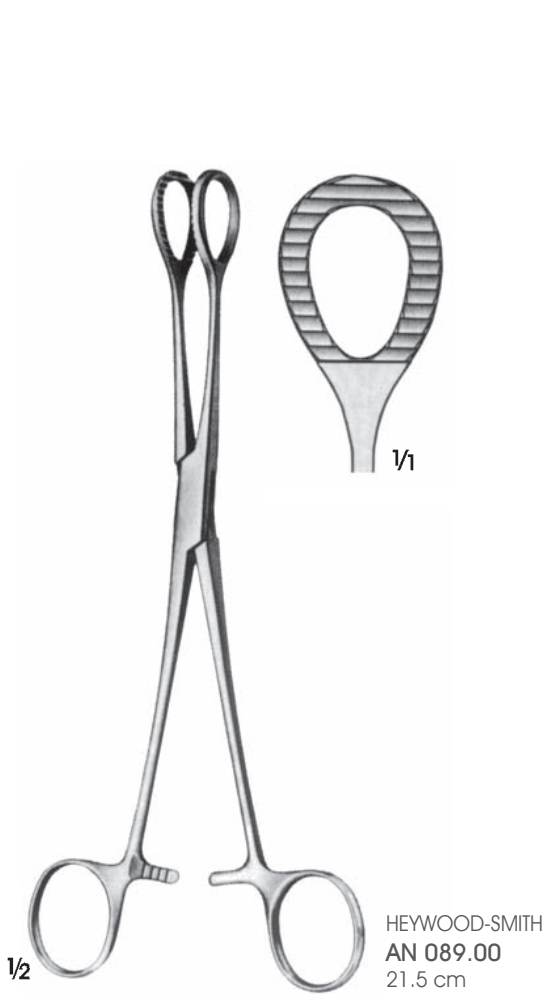

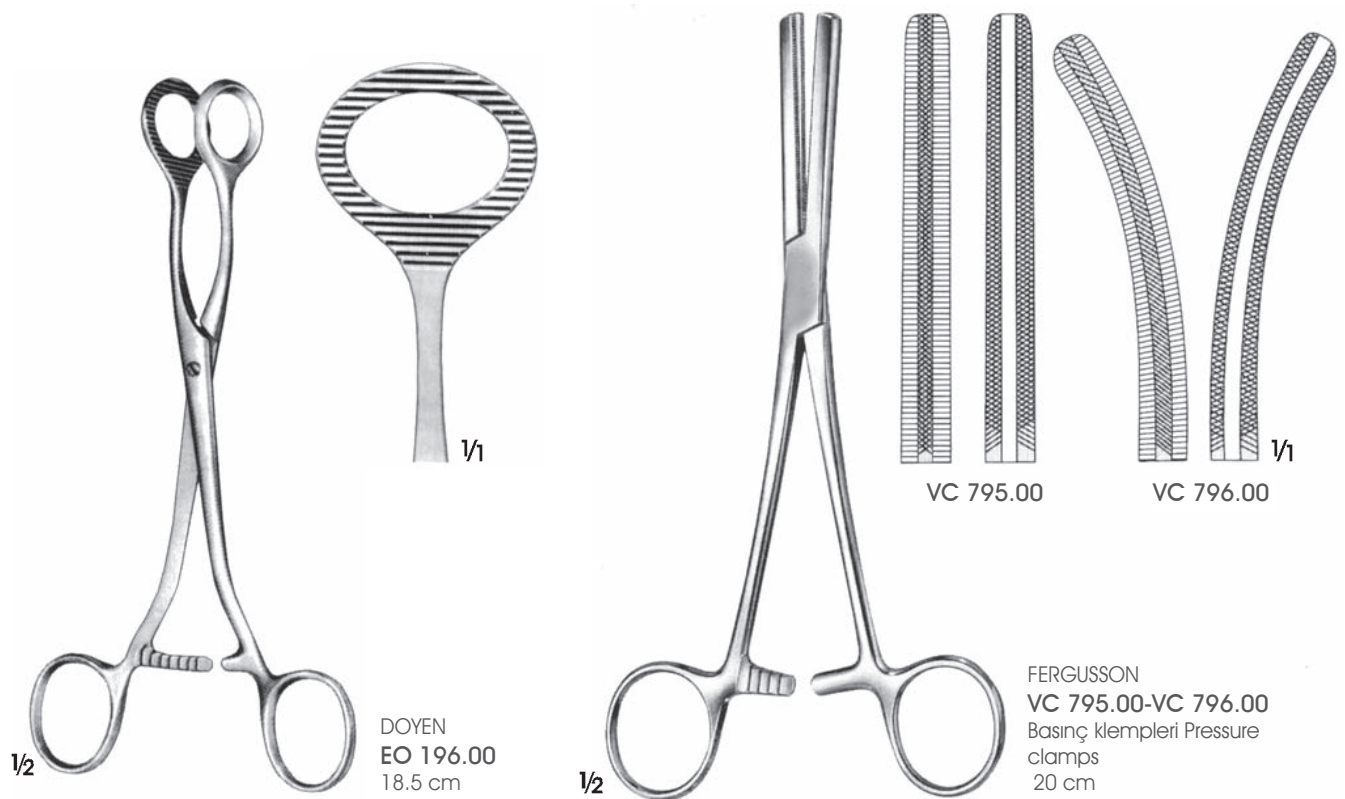
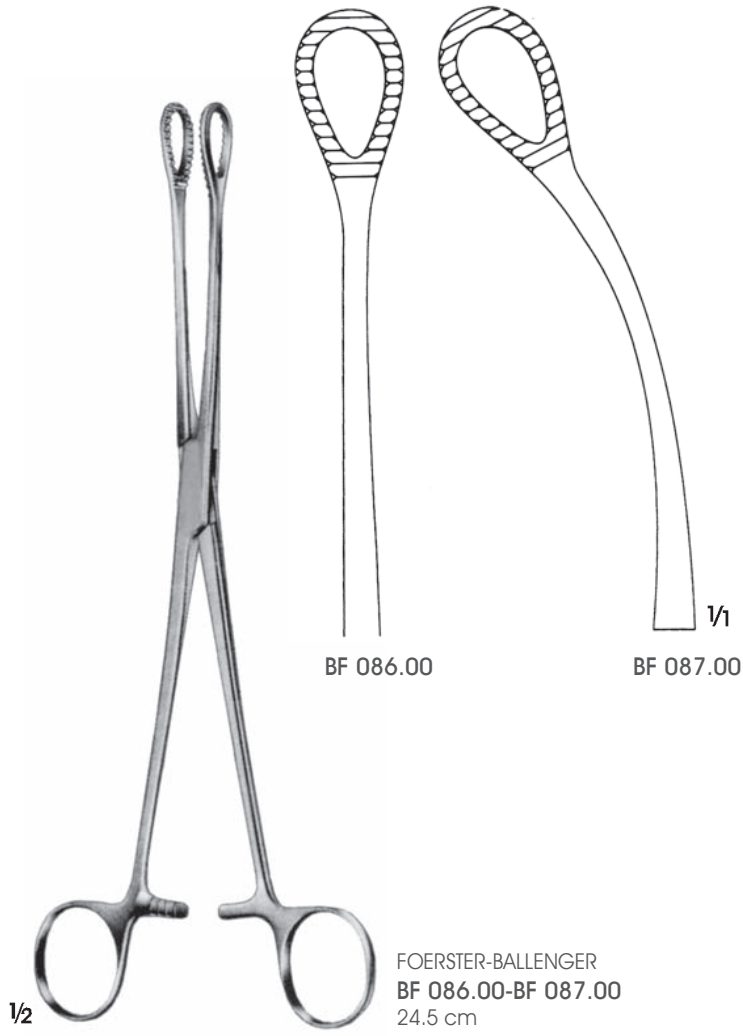

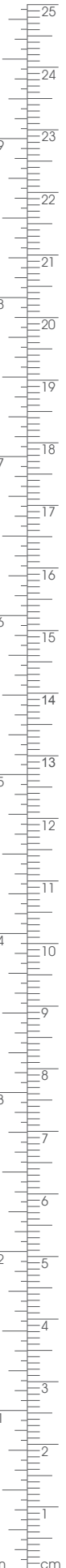
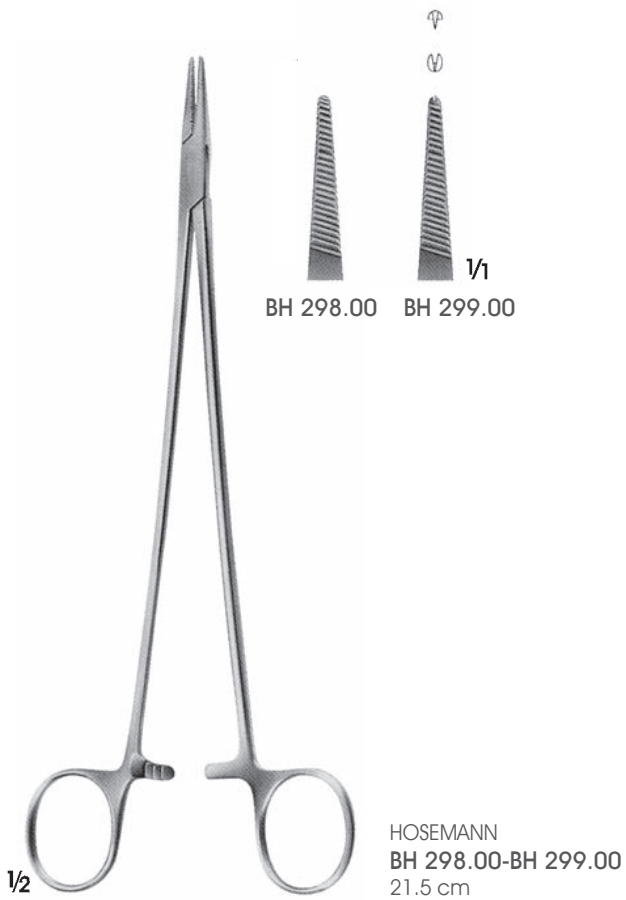
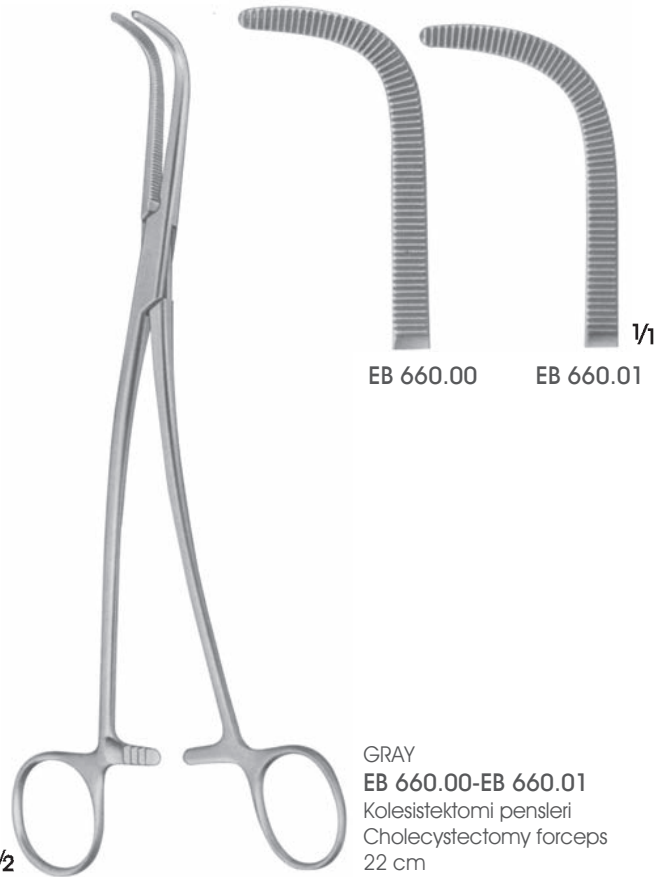

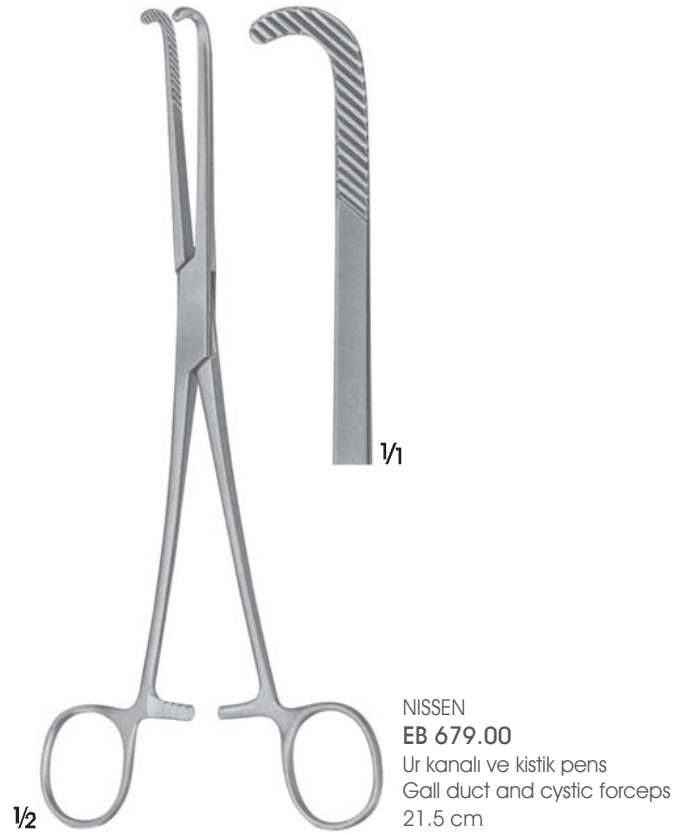
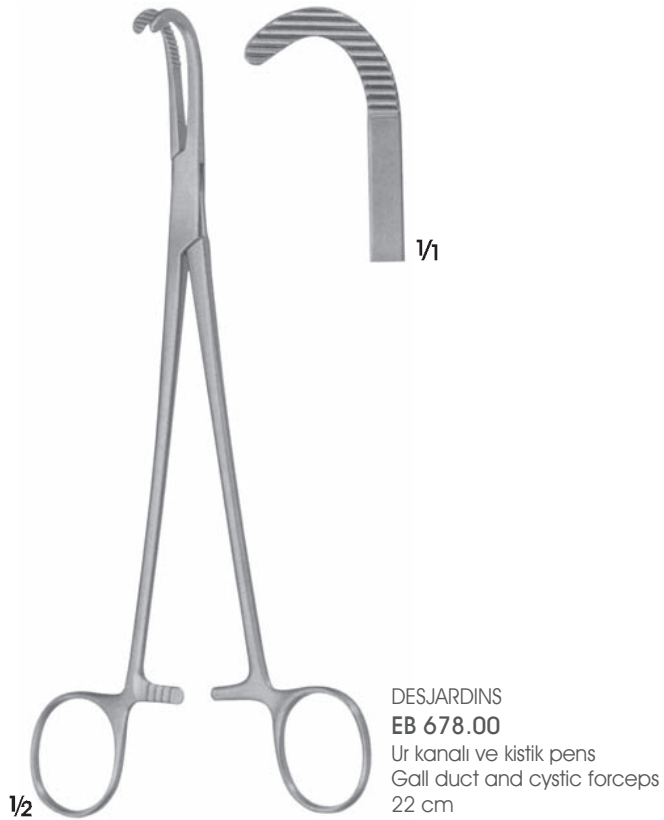
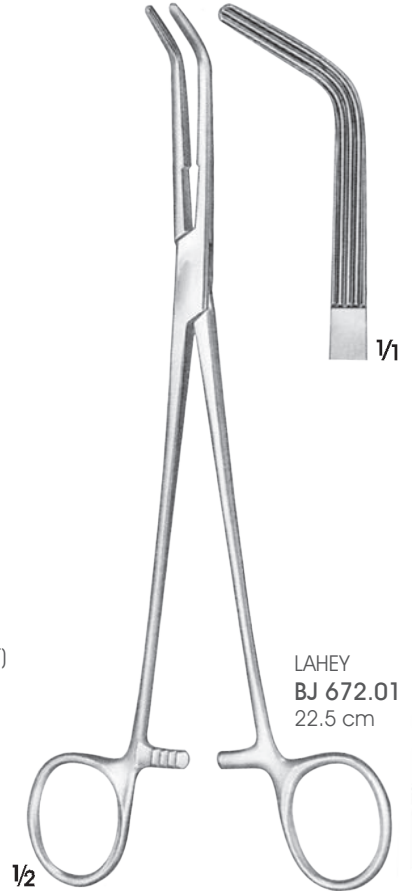

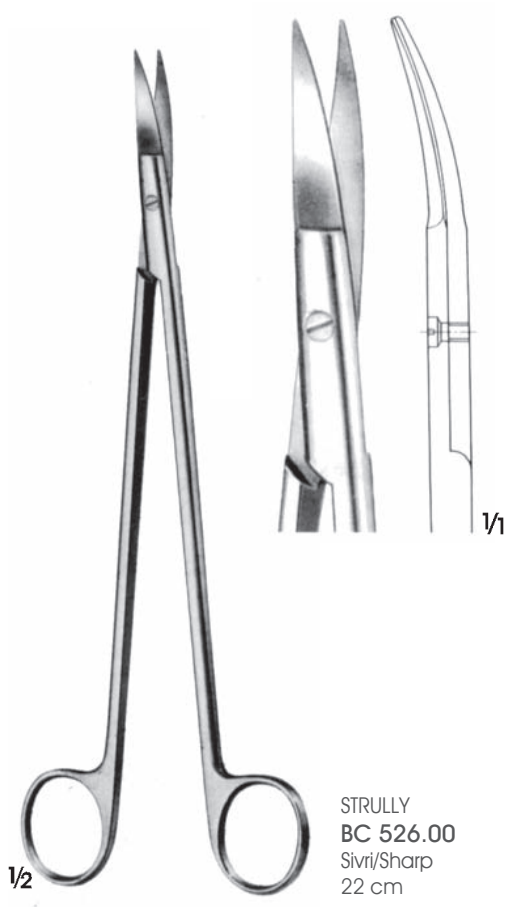

STRULLY
BC 526.00
Sivri/Sharp
22 cm

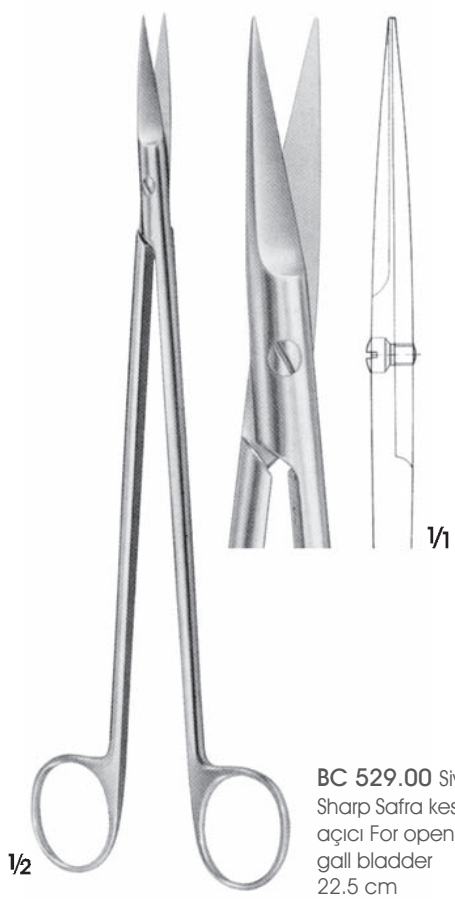

BC 529.00 Sivri/
Sharp Safra kesesi
açıcı For opening the
gall bladder
22.5 cm

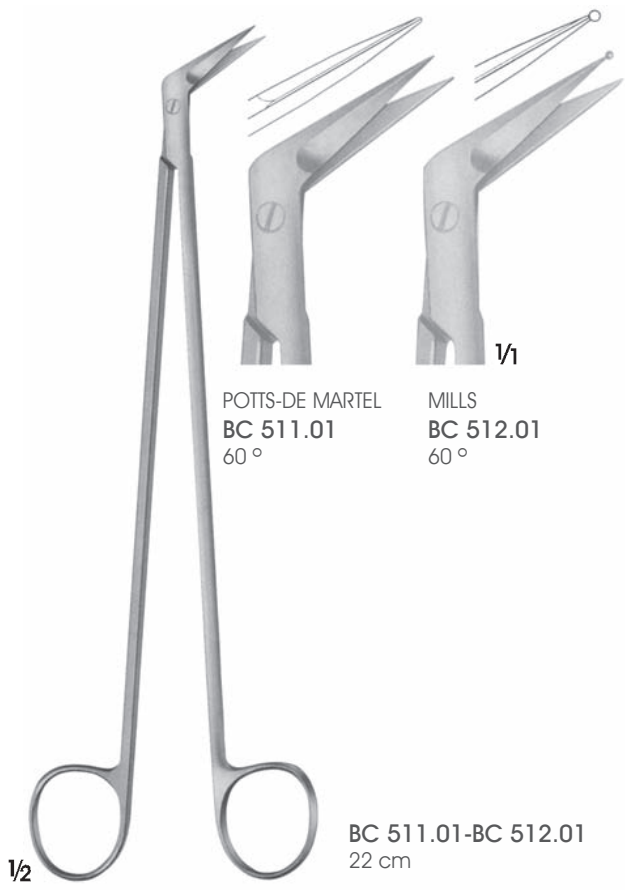

POTTS-DE MARTEL
BC 511.01
60°

MILLS
BC 512.01
60°

BC 511.01-BC 512.01
22 cm



HARDTIPS

60°

DE BAKEY
BC 790.00
22 cm

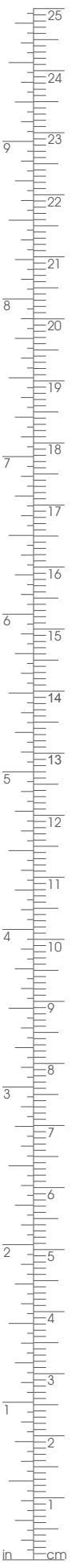



Ø 5 mm

Ø 5 mm

Ø 3.5 mm

Ø 3.5 mm

1/2

1/2

1/2

1/2

1/2

1/2

EB 077.03 EB 077.06 EB 077.09
Ø 3.8 mm Ø 4.3 mm Ø 6.8 mm

1/1

HAJEK
OK 357.01
Sulama kanülü
Irrigating cannula
16.5 cm

DESJARDINS
BE 077.03-BE 077.09
Safra kanalı sondaları, esneyebilir
Gall duct probes, flexible
28.5 cm

MAYNIHAN
EB 070.05
Safra taşı sondası, kaşık ağızlı
bükülebilir
Gall stone probe and-scoop
of tin, malleable
36.5cm

MAYO
EO 650.05
Safra kanalı sonda
bükülebilir
Gall duct probe,
malleable
33 cm

OCHSNER
EB 071.00
Safra kanalı sonda
esneyebilir
Gall duct probe, flexible
40 cm



DESJARDINS
EB 405.02-EB 405.05
Esnek şaft sonda ve yakalayıcı
Probe and catch with flexible shaft
30 cm



LUER-KÖRTE
EB 410.02-EB 410.09
Bükülebilir/Malleable 31
cm

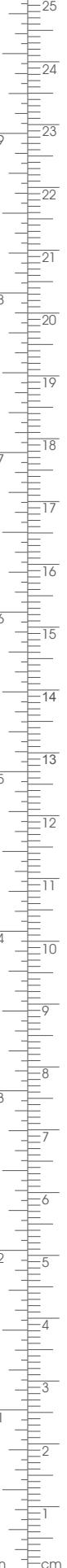
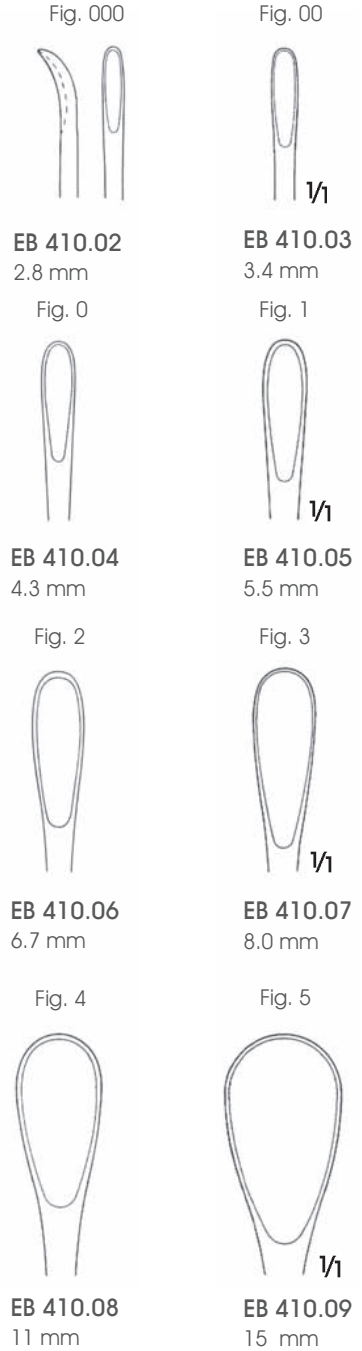

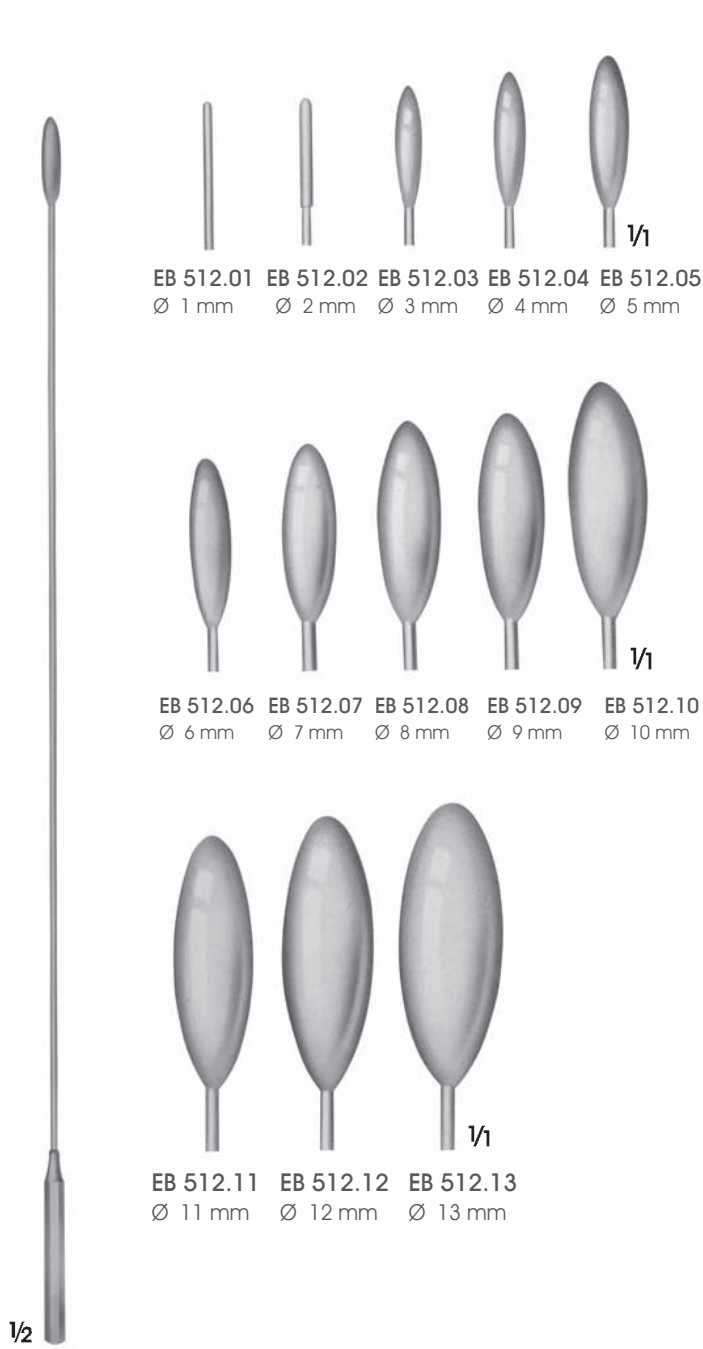

BAKES
EB 512.01-EB 512.13
Safra kanalı için bükülebilir dilatörler
Common bile duct dilators, malleable
31 cm



DITTEL
EF 080.08-EF 080.30
Metal buji ve dilatasyon sondaları
Metal bougies and dilating sounds
34.5 cm

Charr.
(French)

EF 080.08	8
EF 080.09	9
EF 080.10	10
EF 080.11	11
EF 080.12	12
EF 080.13	13
EF 080.14	14
EF 080.15	15
EF 080.16	16
EF 080.17	17
EF 080.18	18
EF 080.19	19
EF 080.20	20
EF 080.21	21
EF 080.22	22
EF 080.23	23
EF 080.24	24
EF 080.25	25
EF 080.26	26
EF 080.27	27
EF 080.28	28
EF 080.29	29
EF 080.30	30

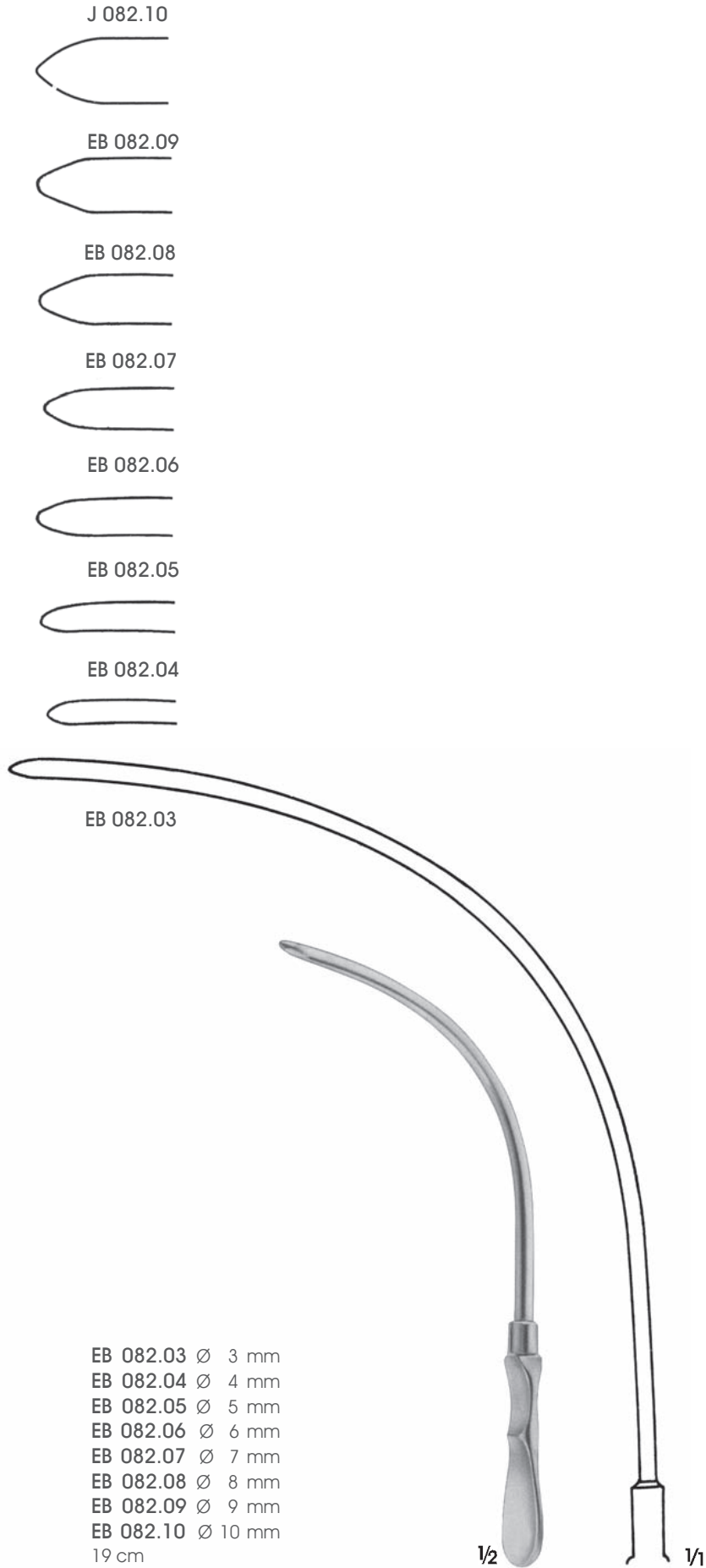

J 082.10

EB 082.09

EB 082.08

EB 082.07

EB 082.06

EB 082.05

EB 082.04

EB 082.03

EB 082.03 Ø 3 mm
EB 082.04 Ø 4 mm
EB 082.05 Ø 5 mm
EB 082.06 Ø 6 mm
EB 082.07 Ø 7 mm
EB 082.08 Ø 8 mm
EB 082.09 Ø 9 mm
EB 082.10 Ø 10 mm
19 cm

1/2

1/1



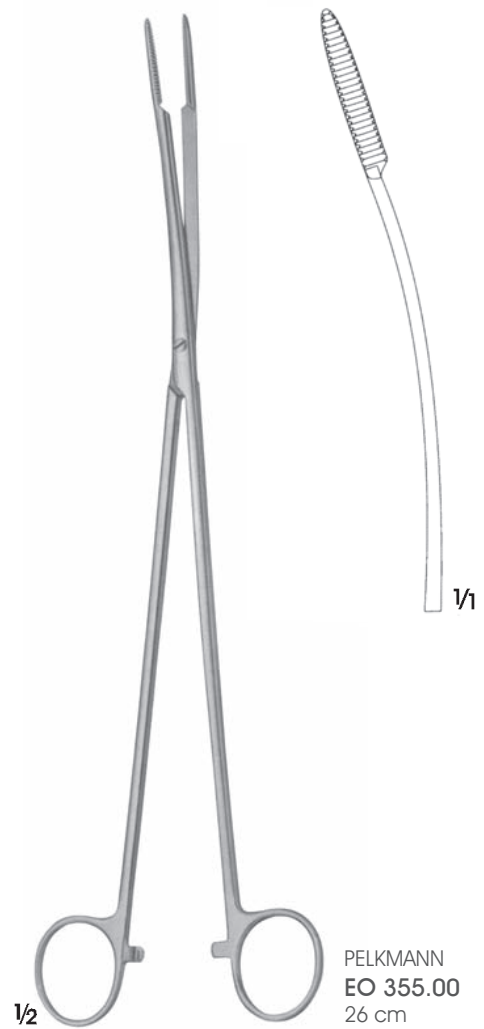
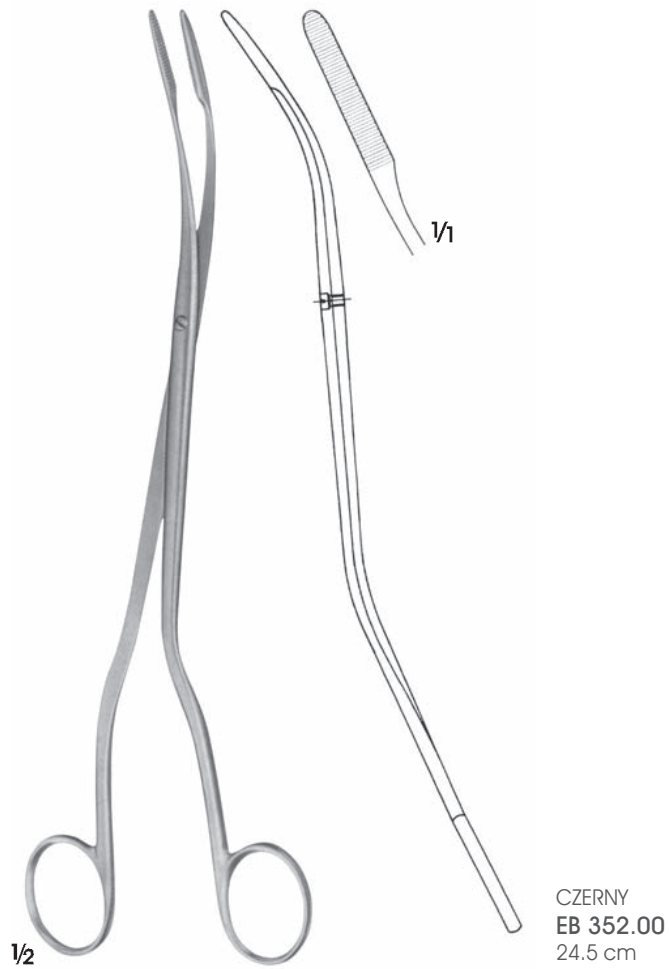
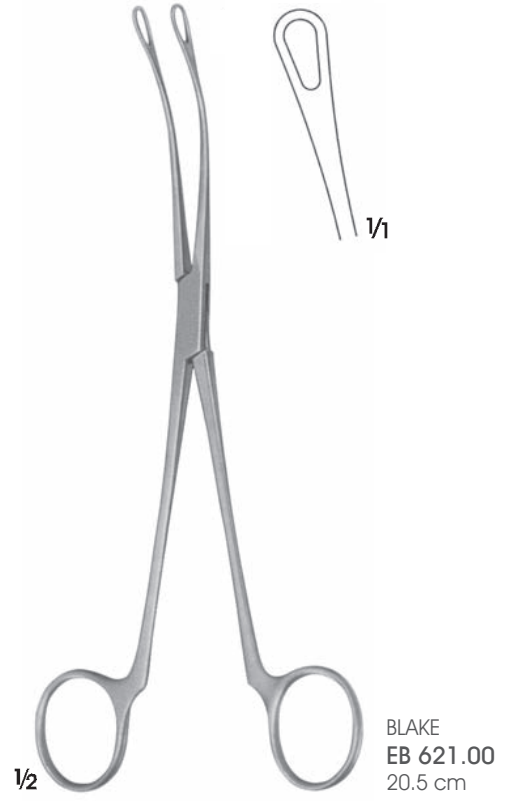
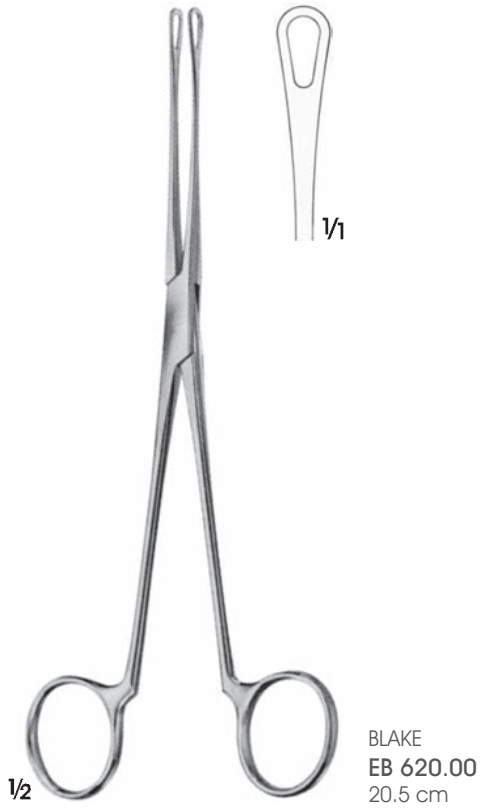



EB 610.02 EB 610.04



EB 610.03 EB 610.05



EB 612.02
24 cm



DESJARDINS
EB 610.02-EB 610.05
22.5 cm



DESJARDINS
EB 612.01-EB 612.02
Hassas model
Extremely delicate patterns

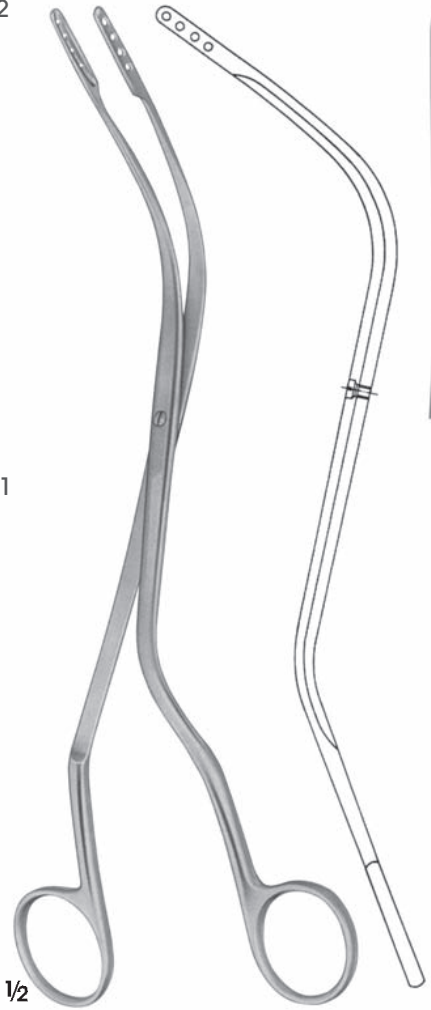

TÜBINGER
EB 613.00
25.5 cm



EB 612.01
22.5 cm

1/1

1/2

1/2

UR Ürolojik Aletler
Genito-Urinary Instruments



 **ARGENT**



PEAN
BH 459.00-BH 459.02



$\frac{1}{2}$

GUYON
EF 468.00
23.5 cm

Atromatik
Atraumatic



1/1



EF 470.04
24 cm



EF 470.02
23 cm

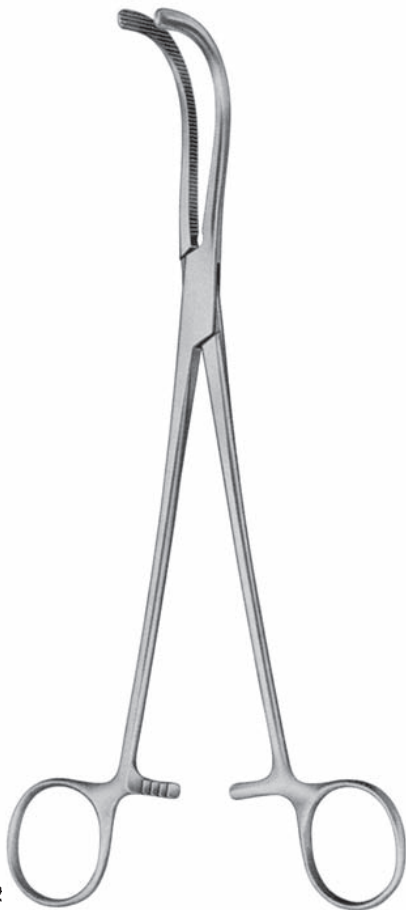

1/2

GUYON
EF 469.02
23 cm



GUYON
EF 470.02-EF 470.05

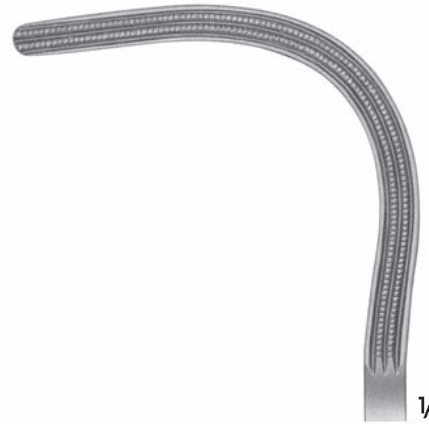

EF 470.05
23 cm

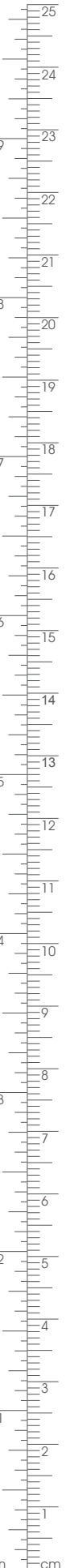



STILLE
EF 475.02
22 cm

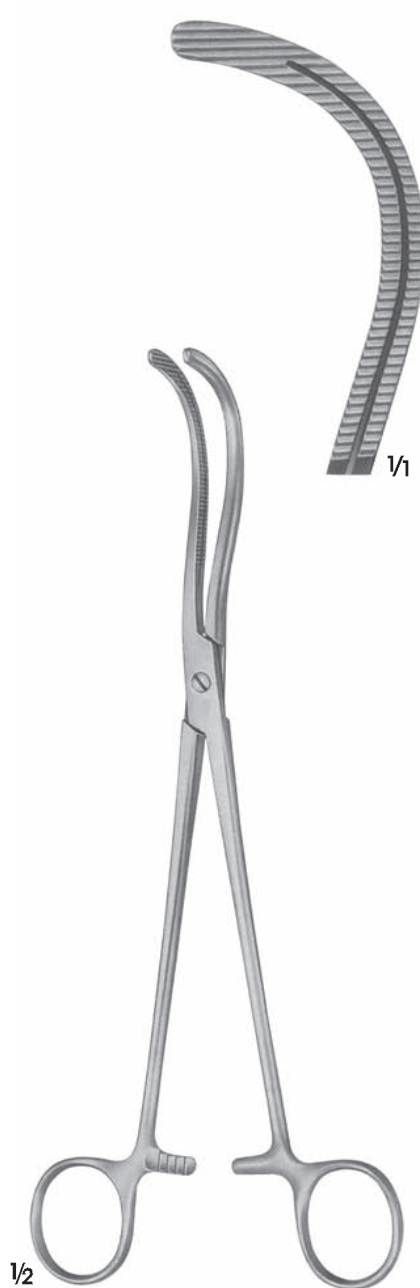

STILLE
EF 476.02
24 cm

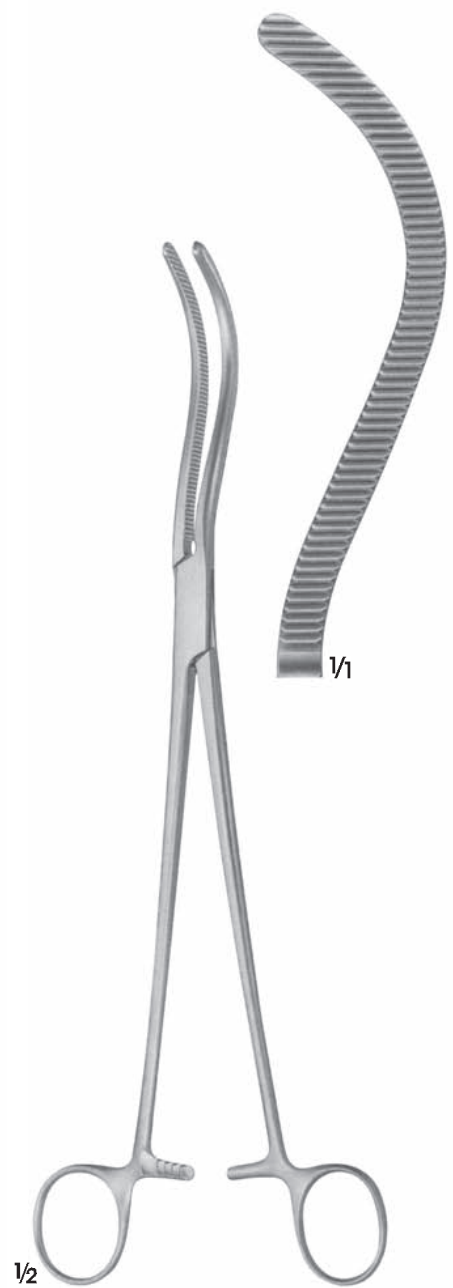

GUYON
EF 478.02
26.5 cm



HERRICK
EF 488.00
22.5 cm



WERTHEIM
BJ 760.00
25.5 cm

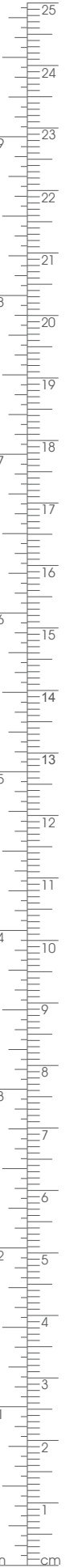

Atromatik
Atraumatic



WERTHEIM - CULLEN
BJ 771.00
Açılı baskı klempi
Angle- and pressure clamp
21.5 cm



WERTHEIM
BJ 770.00
Açılı baskı klempi
Angle- and pressure clamp
25 cm



1/2

DARTIGUES
EO 575.02
25.5 cm



1/2

COLLIN
EO 577.02
28.5 cm

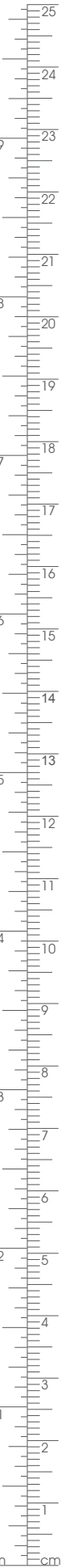

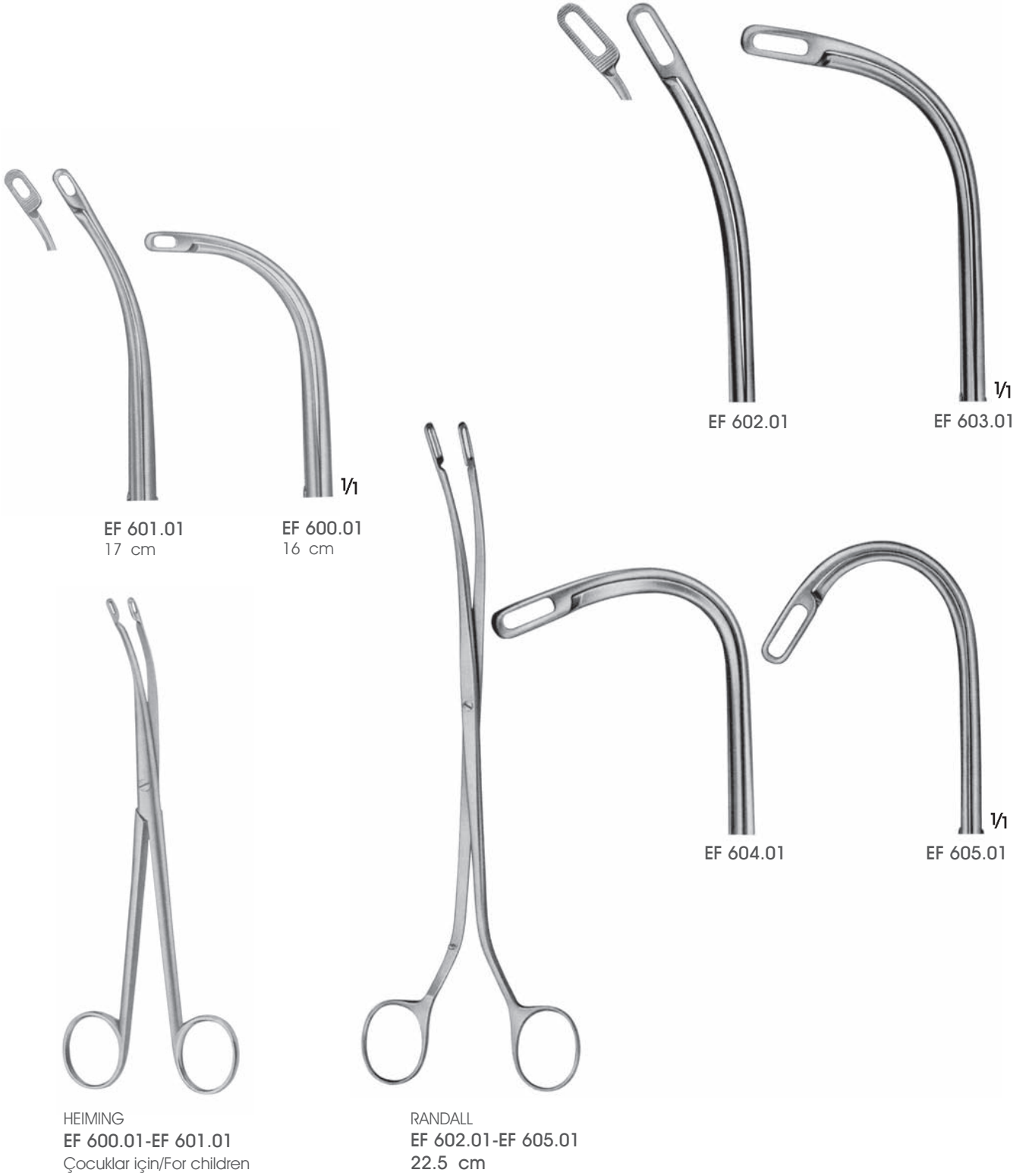



$\frac{1}{1}$
EF 608.01

$\frac{1}{1}$
EF 609.01

$\frac{1}{2}$
RANDALL
EF 608.01-EF 609.01
19 cm

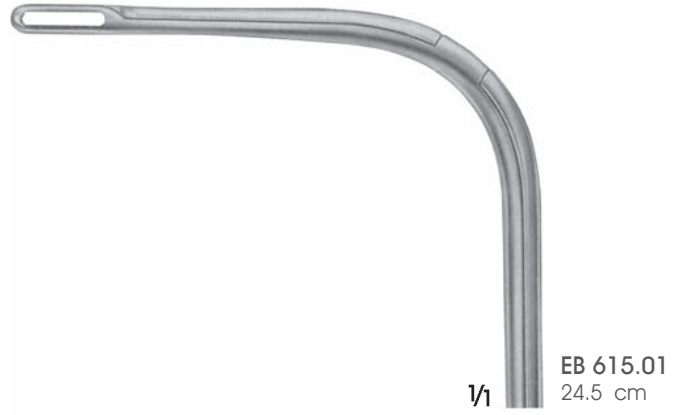

$\frac{1}{1}$
EB 615.01
24.5 cm



$\frac{1}{1}$
EB 614.01
23 cm

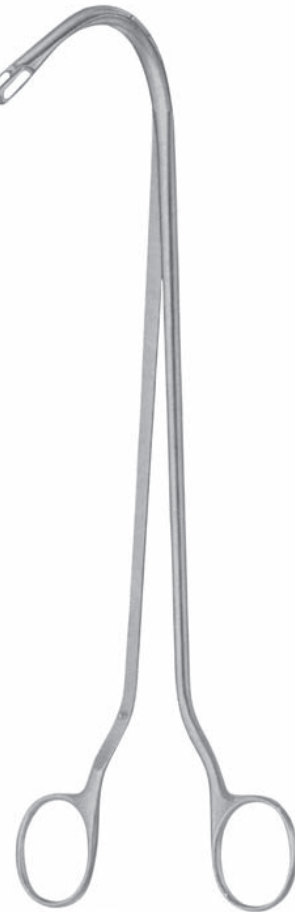

RANDALL
EB 614.01-EB 615.01
Çok hassas model
Extremely delicate patterns



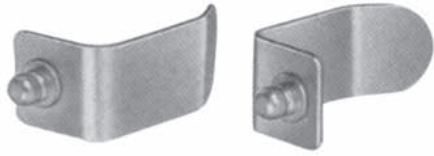

BV 515.05
57 x 25 mm

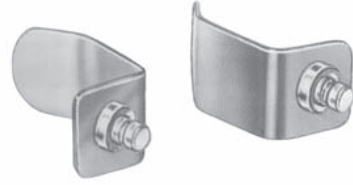

BV 515.05
57 x 25 mm



BV 515.06
82 x 25 mm

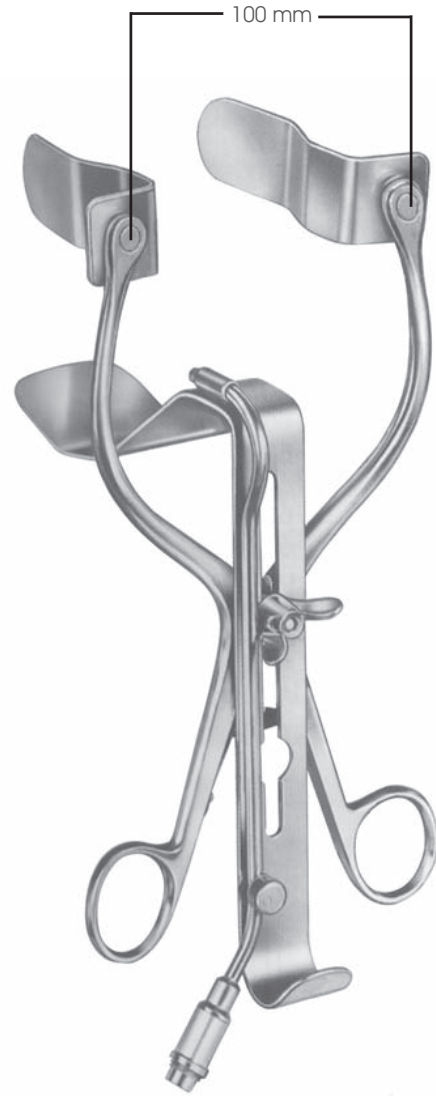

BV 515.06
82 x 25 mm

MILLIN

BV 515.00 Komple/Complete

BV 515.02 Sadece ekartör/Retractor only

BV 515.05 Bleyd 57 x 25 mm/Blades 57 x 25 mm

BV 515.06 Bleyd 82 x 25 mm/Blades 82 x 25 mm

BV 515.11 Orta bleyd 105 x 45 mm/Center blade 105 x 45 mm

MILLIN

BV 515.01 Komple/Complete

Işık taşıyıcılı/With light carrier

BV 515.02 Sadece ekartör/Retractor only

BV 515.05 Bleyd 57 x 25 mm/Blades 57 x 25 mm

BV 515.06 Bleyd 82 x 25 mm/Blades 82 x 25 mm

BV 515.12 Orta bleyd 105 x 45 mm/Center blade 105 x 45 mm



KOCHER
BV 722.00
Mesane ekartör
Bladder retractor
26 cm

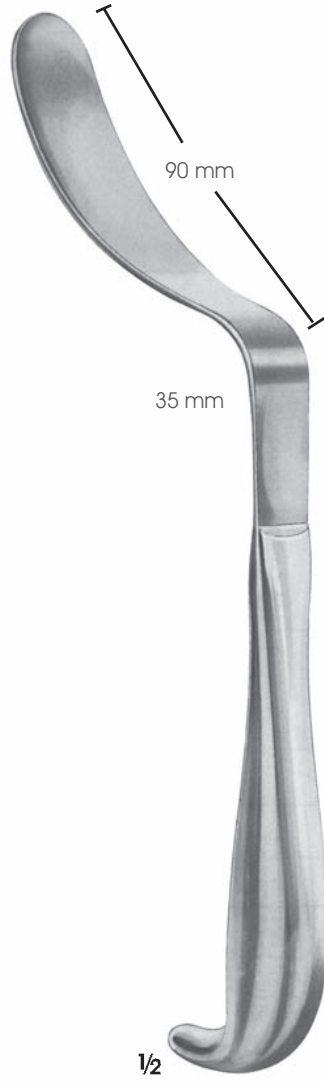

LEGUEU
BV 723.00
Mesane spatula
Bladder spatula
26 cm



MILLIN
EF 558.01
Mesane ayırıcı
Bladder neck spreader
28.5 cm

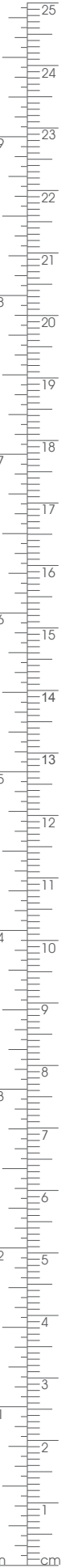

Atromatik
Atraumatic



Atromatik
Atraumatic

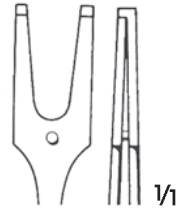

MILLIN
EF 534.00
Lobe yakalama pensi
Lobe grasping forcecp
23.5 cm



MILLIN
EF 536.00
Lobe tutma pensi
Lobe grasping forcecp
24.5 cm



MILLIN
EF 408.00
Bağ tutucu pens
Ligature holding forcecp
24.5 cm

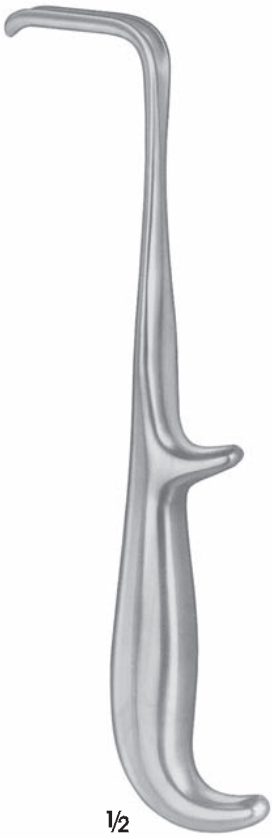

1/2
YOUNG
BT 765.00
21 cm



1/2
YOUNG
BT 767.00
21 cm



1/2
BT 726.00
Prostat ekartör
Prostate retractor
36 cm



1/2
BT 726.01
Üretral ekartör
Urethral retractor
39 cm

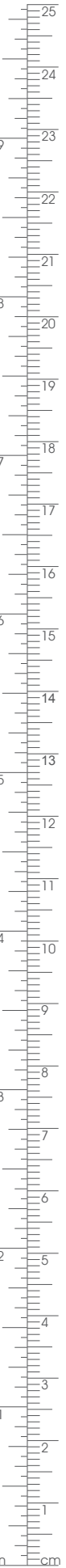

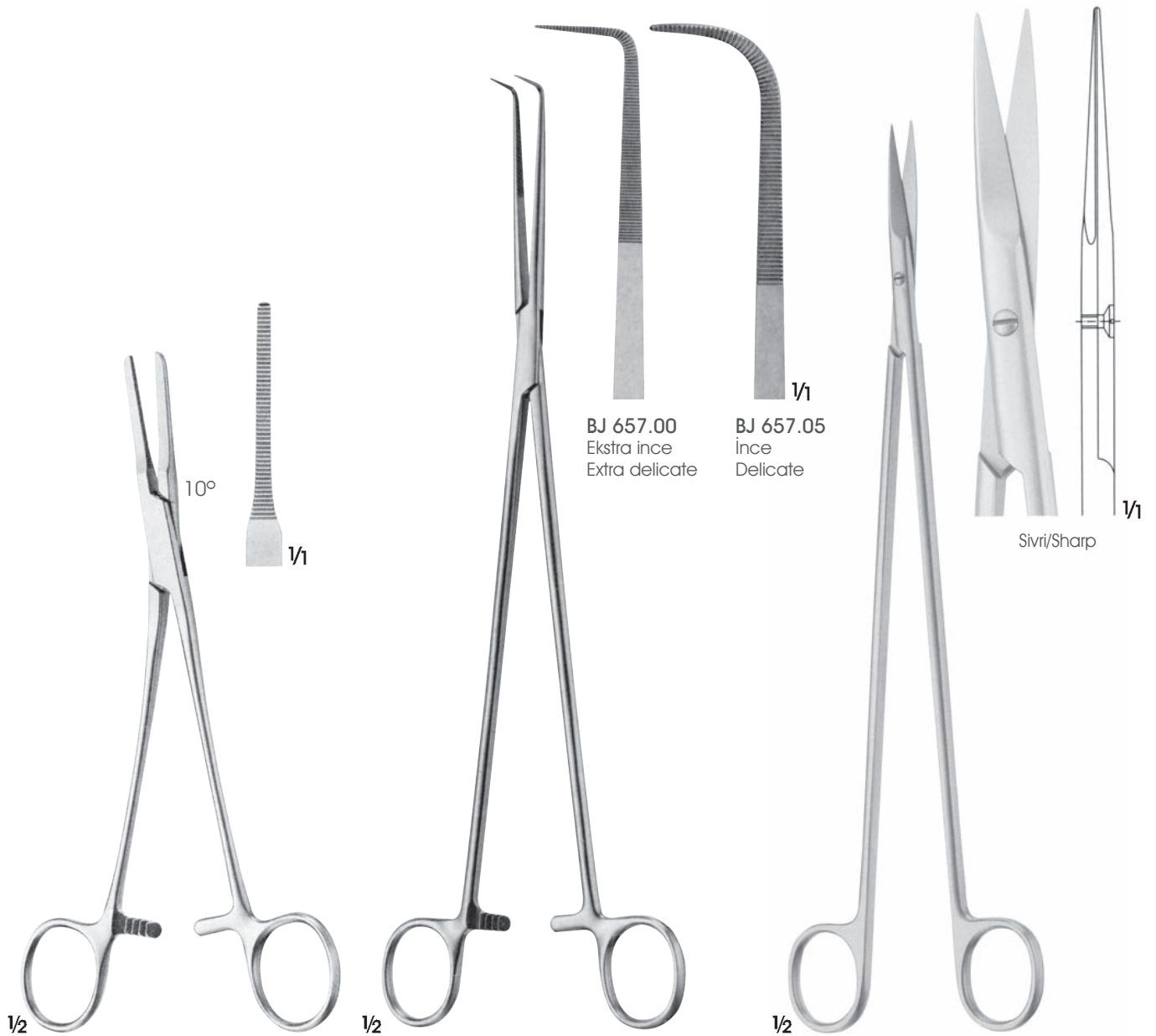

EF 443.01
Venöz plexus klemp
Venous plexus clamp
21 cm

BARRE
BJ 657.00-BJ 657.05
Diseksiyon penleri
Dissecting forceps 28
cm

BARRE
BC 521.00
Diseksiyon makası
Dissecting scissors
28 cm



BARRE
BB 035.00
No.3 XL
Sol el için
For left hand
25 cm



BARRE
BB 036.00-BB 036.01
No.3 XL
Sol el için
For left hand
25 cm



BB 036.00 BB 036.01
12° 25°



BM 400.00



BM 400.01



BM 400.02



1/2
YOUNG-HRYNTSCHAK
BM 406.00
1 iğne ile F 400.00
With 1 needle F 400.00
24 cm



BARRE
GK 135.01
Bipolar penset
Bipolar forceps
26 cm





EF 543.00
Ø 4.8 mm
Glans ve sünnnet derisi
tutma pensi
Forceps for grasping the glans
and the foreskin
12.5 cm



EF 545.00
Testis sabitleme klempi
Fixation clamp for the
spermatic cord
14.5 cm

Atromatik
Atraumatic



BT 171.00
Testis bağlayıcı huk
Hook for the spermatic cord
16.5 cm

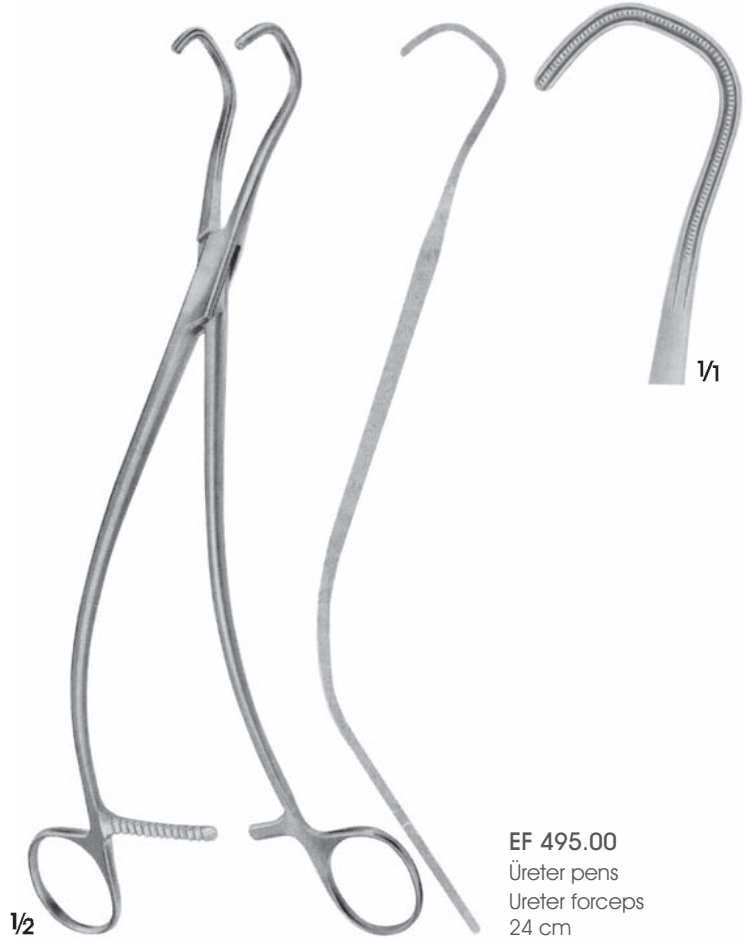

EF 495.00
Üreter pens
Ureter forceps
24 cm

- İki adet hemostatik veya ligatür pens yardımı ile sünnet derisi çan şeklindeki koruma çubuğu üzerine çekilir ve glans yuvaya yerleştirilir.
 - Bu şekilde, kelebek somun sıkılarak, olabildiğince kapama sağlanır. Böylelikle sünnet derisi halka şeklinde sıkıştırılır. Sünnet derisi bistüri yardımı ile sıkma çemberinin hemen kenarından kesilir.
 - Sünnet çanı kanamayı önlemek amacı ile bir kaç dakika bekletilir. Özellikle frenular arter damarının büyük olması ve kesilmesi gerektiği durumlarda dikiş takımı hazır bulundurulmalıdır.
 - Tanımlanan metodun avantajı, küçük ölçü dokunun bıraktığı yara izinin estetik olarak uygun olmasıdır.
-
- Foreskin is pushed over the bell-shaped protection rod with the help of two hemostatic or ligature forceps and the glans is placed into cavity on the rod.
 - In this position, wing nut is tightened as close as possible for guaranteeing annular copression on the foreskin. Then foreskin is cut off with scalpel, right next to the compression ring.
 - The circumcision clamp is kept in compressed position for few minutes for avoiding bleeding. In case of large vein of frenular artery is cut artery is cut through, the ligature set should be kept ready.
 - The advantage of the method described is aesthetically favorable scar after operation.

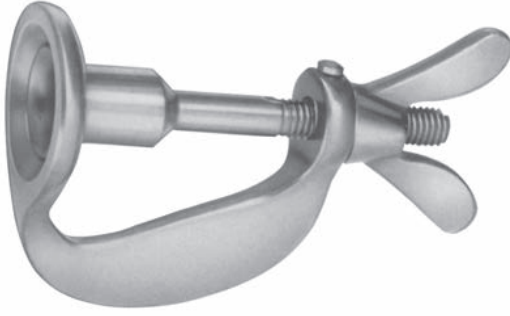

WINKELMANN
EF 465.00 Ø 12 mm
EF 465.01 Ø 16 mm
EF 465.02 Ø 20 mm
Sünnet klempleri
Circumcision clamps

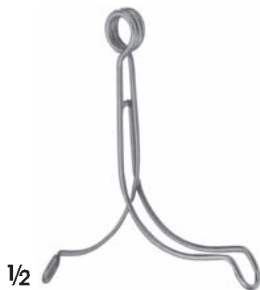

STOCKMANN
EF 460.00
Penis klempe
Penis clamp
7 cm



STRAUSS
EF 461.00
Penis klempe
Penis clamp
13 cm





MATHIEU
EF 800.00
Yabancı cisim pensi
Foreign body forceps
19 cm



PITHA
EF 351.00
Yabancı cisim pensi
Foreign body forceps
22 cm



ASCH
EF 585.01
Uterin kaşık küret, künt
Uterine secretion scoop, blunt
20 cm



EF 090.03-090.06
Uterin sonda Uterine
probe
33 cm

	Charr.
EF 090.03	3
EF 090.04	4
EF 090.05	5
EF 090.06	6



1/2

	Charr.
EF 094.08	8
EF 094.10	10
EF 094.12	12
EF 094.14	14
EF 094.16	16
EF 094.18	18
EF 094.20	20

EF 094.08-EF 094.20

Erkekler için metal katater
Male catheters, metal
29 cm



1/1

	Charr.
EF 095.06	6
EF 095.07	7
EF 095.08	8
EF 095.09	9
EF 095.10	10
EF 095.11	11
EF 095.12	12
EF 095.13	13
EF 095.14	14
EF 095.15	15
EF 095.16	16
EF 095.18	18
EF 095.20	20

EF 095.06-EF 095.20

Bayanlar için metal katater
FEMALE catheters, metal
15.5 cm



1/4

EF 097.10

Katater kılavuz
Catheter guide
49 cm





1/3

GUYON
EF 098.02
Katater klavuz
Catheter guide
36.5 cm



1/3

EF 099.02
Katater için uygulayıcı
Introducer for catheters
46 cm



1/2

DITTEL
EF 080.08-EF 080.30
Üretral dilatasyon bujileri
Urethral dilating bougies
34.5 cm

Charr.

EF 080.08	8
EF 080.09	9
EF 080.10	10
EF 080.11	11
EF 080.12	12
EF 080.13	13
EF 080.14	14
EF 080.15	15
EF 080.16	16
EF 080.17	17
EF 080.18	18
EF 080.19	19
EF 080.20	20
EF 080.21	21
EF 080.22	22
EF 080.23	23
EF 080.24	24
EF 080.25	25
EF 080.26	26
EF 080.27	27
EF 080.28	28
EF 080.29	29
EF 080.30	30



1/2

GUYON
EF 092.24-EF 092.60
Üretral dilatasyon bujileri
Urethral dilating bougies
25.5 cm

- EF 092.24 Ben 24/ Charr.12
- EF 092.25 Ben.25
- EF 092.26 Ben 26/ Charr.13
- EF 092.27 Ben.27
- EF 092.28 Ben 28/ Charr.14
- EF 092.29 Ben.29
- EF 092.30 Ben 30/ Charr.15
- EF 092.31 Ben.31
- EF 092.32 Ben 32/ Charr.16
- EF 092.33 Ben.33
- EF 092.34 Ben 34/ Charr.17
- EF 092.35 Ben.35
- EF 092.36 Ben 36/ Charr.18
- EF 092.37 Ben.37
- EF 092.38 Ben 38/ Charr.19
- EF 092.39 Ben.39
- EF 092.40 Ben 40/ Charr.20
- EF 092.41 Ben.41
- EF 092.42 Ben 42/ Charr.21
- EF 092.43 Ben.43
- EF 092.44 Ben 44/ Charr.22
- EF 092.45 Ben.45
- EF 092.46 Ben 46/ Charr.23
- EF 092.47 Ben.47
- EF 092.48 Ben 48/ Charr.24
- EF 092.49 Ben.49
- EF 092.50 Ben 50/ Charr.25
- EF 092.51 Ben.51
- EF 092.52 Ben 52/ Charr.26
- EF 092.53 Ben.53
- EF 092.54 Ben 54/ Charr.27
- EF 092.55 Ben.55
- EF 092.56 Ben 56/ Charr.28
- EF 092.57 Ben.57
- EF 092.58 Ben 58/ Charr.29
- EF 092.59 Ben.59
- EF 092.60 Ben 60/ Charr.30



1/2

TURNER WARWICK
EF 093.00
Gerici buji
Retrograde bougie
18 cm

JN Jinekolojik Aletler
Gynaecological Instruments



 **ARGENT**

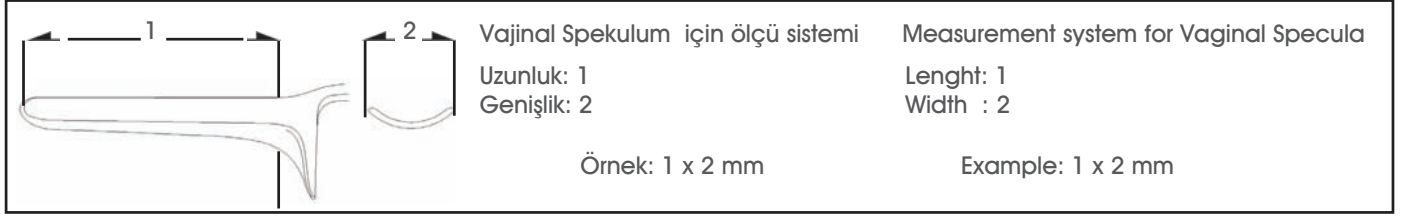

COLLIN
EL 750.01
53 x 10 mm
Çocuklar için/For children



COLLIN
EL 752.01
95/85 x 18 mm
Bakireler için/For virgins

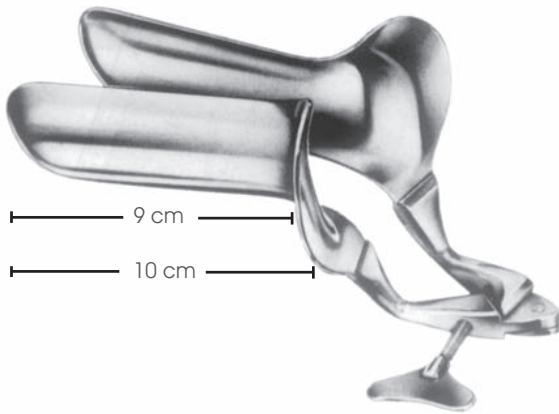

COLLIN	Tam boy/Çalışma boy Total length/Working length	En Width
EL 754.01	100/90 mm	28 mm
EL 754.02	100/90 mm	32 mm
EL 754.03	105/95 mm	35 mm
EL 754.04	115/105 mm	40 mm



TRELAT	
EL 785.01	85 x 33 mm
EL 785.02	95 x 35 mm
EL 785.03	115 x 43 mm

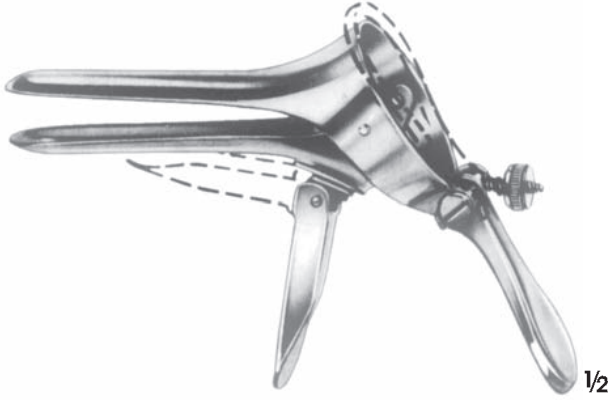

CUSCO
EL 760.01
75 x 17 mm
Bakireler için/For virgins



CUSCO
EL 770.01
75 x 17 mm
Bakireler için/For virgins



CUSCO STANDARD
EL 762.01 80 x 24 mm
EL 762.02 80 x 32 mm
EL 762.03 90 x 36 mm
EL 762.04 110 x 37
mm Standart model
Standard patterns



İsviçre örneği
Özellikleri: Uzun ve dar
Swiss patterns
Fatures: Long and narrow

CUSCO
EL 763.01 92 x 23 - 25 mm
EL 763.02 100 x 25 - 27 mm
EL 763.03 110 x 27 - 30 mm





CUSCO
EL 765.01 80 x 32 mm
EL 765.02 90 x 37 mm
EL 765.04 115 x 37 mm
mm Yassı (Ördek gagası) Flat (Duck beak)

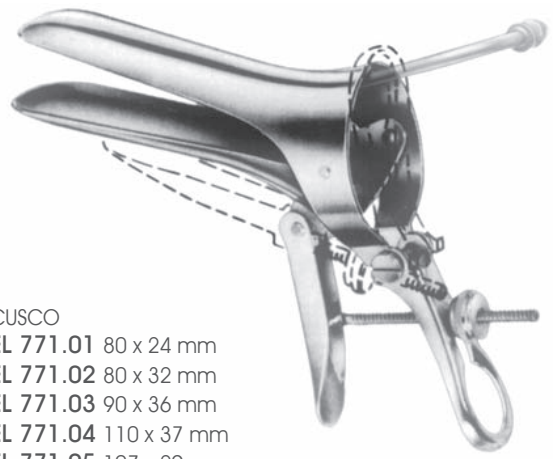

CUSCO
EL 771.01 80 x 24 mm
EL 771.02 80 x 32 mm
EL 771.03 90 x 36 mm
EL 771.04 110 x 37 mm
EL 771.05 107 x 29 mm
EL 771.06 115 x 35 mm
Aspiratör uęlu/With suction tube



GRAVE
EL 790.01 75 x 20 mm
EL 790.02 95 x 30 mm
EL 790.03 105 x 33 mm



PEDERSON
EL 791.01 100 x 22 mm
EL 791.02 120 x 25 mm



Parmak baskısıyla açılıp kapanan çift işaretili
With double ratchet, closing and opening of
ratchet by pressure of thumb

SEMM
EL 780.01
90 x 14 -18 mm
Çocuk ve bakireler için
For children and virgins

1/2



Parmak baskısıyla açılıp kapanan çift işaretili
With double ratchet, closing and opening of
ratchet by pressure of thumb

SEMM
EL 781.01 100 x 20 - 24 mm
EL 781.05 100 x 30 - 34 mm
18.5 cm

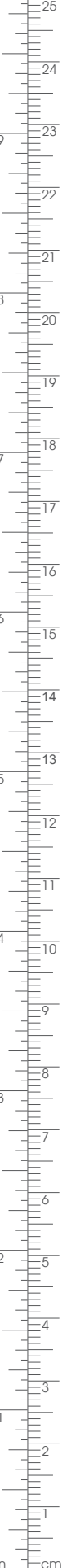

SEYFFERT
EL 782.01 100 x 17 mm
EL 782.05 100 x 33 mm
23 cm

Alet ve kataterleri çıkarmak için bir tarafı açık
One side open for faking up instruments and
catheters



SEYFFERT
EL 783.01 110 x 33 mm
23 cm

1/2



SEIDL
EL 804.01 80 x 8 mm
EL 804.02 80 x 10 mm
EL 804.03 90 x 14 mm
Çocuklar ve bebekler için
For children and infants
17 cm



KRISTELLER
EL 806.01 70 x 15
mm Çocuklar için
For children
17 cm



KRISTELLER
EL 807.01 70 x 27 mm
EL 807.02 75 x 30 mm
EL 807.03 90 x 36 mm
17.5 cm



KRISTELLER
EL 809.02 110 x 18 mm
EL 809.03 110 x 20 mm
EL 809.04 110 x 27 mm
EL 809.05 110 x 30 mm
EL 809.06 110 x 36 mm
22 cm

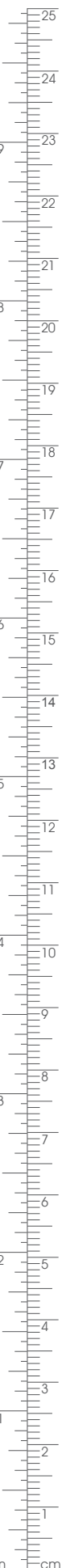

KRISTELLER
EL 814.00-EL 814.03
Üst bleyd/Upper blades

EL 814.00
75 x 10 mm
17.5 cm



EL 814.01
75 x 23 mm
18 cm



EL 814.02
80 x 25 mm
18 cm



EL 814.03
100 x 32 mm
18.5 cm



1/2



KRISTELLER
EL 812.00-EL 812.03
Alt bleyd/Lower blade

EL 812.00
70 x 15 mm
17.5 cm



EL 812.01
70 x 27 mm
18 cm



EL 812.02
75 x 30 mm
18 cm



EL 812.03
90 x 36 mm
18.5 cm



1/2



KRISTELLER
 EL 814.04-EL 814.08
 Üst bleyd/Upper blades



KRISTELLER
 EL 812.04-EL 812.08
 Alt bleyd/Lower blades

EL 814.04
 115 x 14 mm
 21.5 cm



EL 814.05
 115 x 23 mm
 21.5 cm

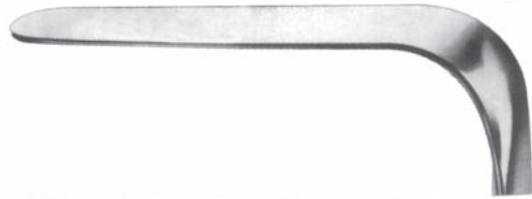

EL 814.06
 115 x 16 mm
 22 cm

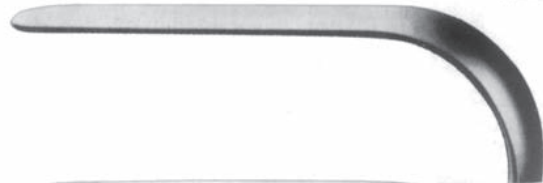

EL 814.07
 115 x 26 mm
 22 cm



EL 814.08
 120 x 30 mm
 22.5 cm



1/2

EL 812.04
 110 x 18 mm
 21.5 cm



EL 812.05
 110 x 27 mm
 21.5 cm

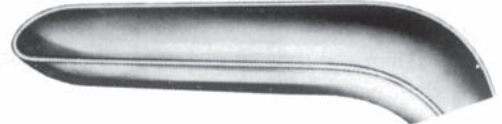

EL 812.06
 110 x 20 mm
 22 cm



EL 812.07
 110 x 30 mm
 22 cm

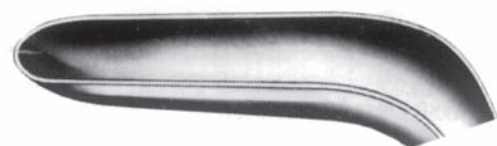

EL 812.08
 110 x 36 mm
 22.5 cm

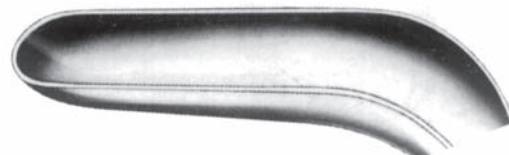

1/2



KRISTELLER
EL 817.02-EL 817.04
Üst bleyd/Upper blades
20.5 cm

1/2

EL 817.02
80 x 28 mm



EL 817.03
85 x 35 mm



EL 817.04
85 x 40 mm



1/2



JACKSON
EL 819.02-EL 819.04
Alt bleyd/Lower blades

1/2

EL 819.02
76 x 38 mm



EL 819.03
89 x 38 mm



EL 819.04
110 x 38 mm



1/2





KALLMORGEN
EL 825.01 Set/
Set 75 x 39 mm
17 cm

1/2



KALLMORGEN
EL 826.01 Set/
Set 95 x 39 mm
20 cm

1/2

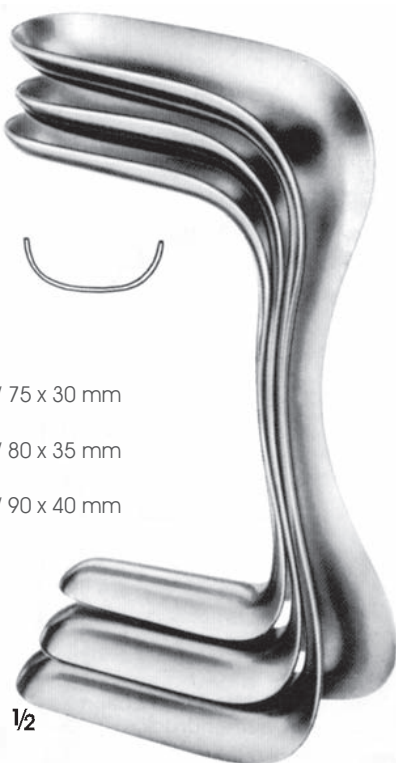

SIMS
EL 832.01 70 x 26 / 75 x 30 mm
12.5 cm
EL 832.05 75 x 30 / 80 x 35 mm
15 cm
EL 832.08 80 x 36 / 90 x 40 mm
17.5 cm

1/2



BREISKY
EL 830.01 72 x 25 / 77 x 30 mm
14 cm
EL 830.05 75 x 30 / 92 x 38 mm
17 cm

1/2

EL 841.03
110 x 20 mm



EL 841.04
110 x 30 mm



EL 841.05
110 x 36 mm



EL 841.03-EL 841.05
Alt bleyd/Lower blade
21.5 cm

EL 841.06
115 x 18 mm



EL 841.07
115 x 26 mm



EL 841.08
115 x 32 mm



KRISTELLER
EL 841.06-EL 841.08
Üst bleyd/Upper blade
22 cm

KRISTELLER
EL 841.00 110 x 20 mm
EL 841.01 110 x 30 mm
EL 841.02 110 x 36 mm
Viyana model set Vienna
patterns sets

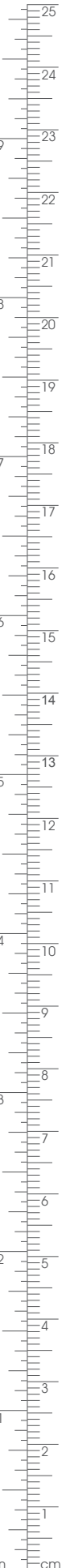



1/2
BRAUN
EL 850.01
56 x 13 mm
18 cm



1/2
BRAUN
EL 851.01
60 x 10 mm
18 cm



1/2
HEANEY
BT 815.00
89 x 29 mm
17 cm



1/2
EASTMAN
BT 818.00
89 x 38 mm
17.5 cm



1/2
LONDON
EL 854.00
89 x 25 mm
19.5 cm



1/2
MATHIEU
EL 843.01
İç bleyd/Inner blade
95 x 17 - 30 mm
21 cm



1/2
MATHIEU
EL 844.01
Üst bleyd/Upper blade
95 x 17 - 26 mm
(İç bleyd/Inner blade K 843.01)
21 cm

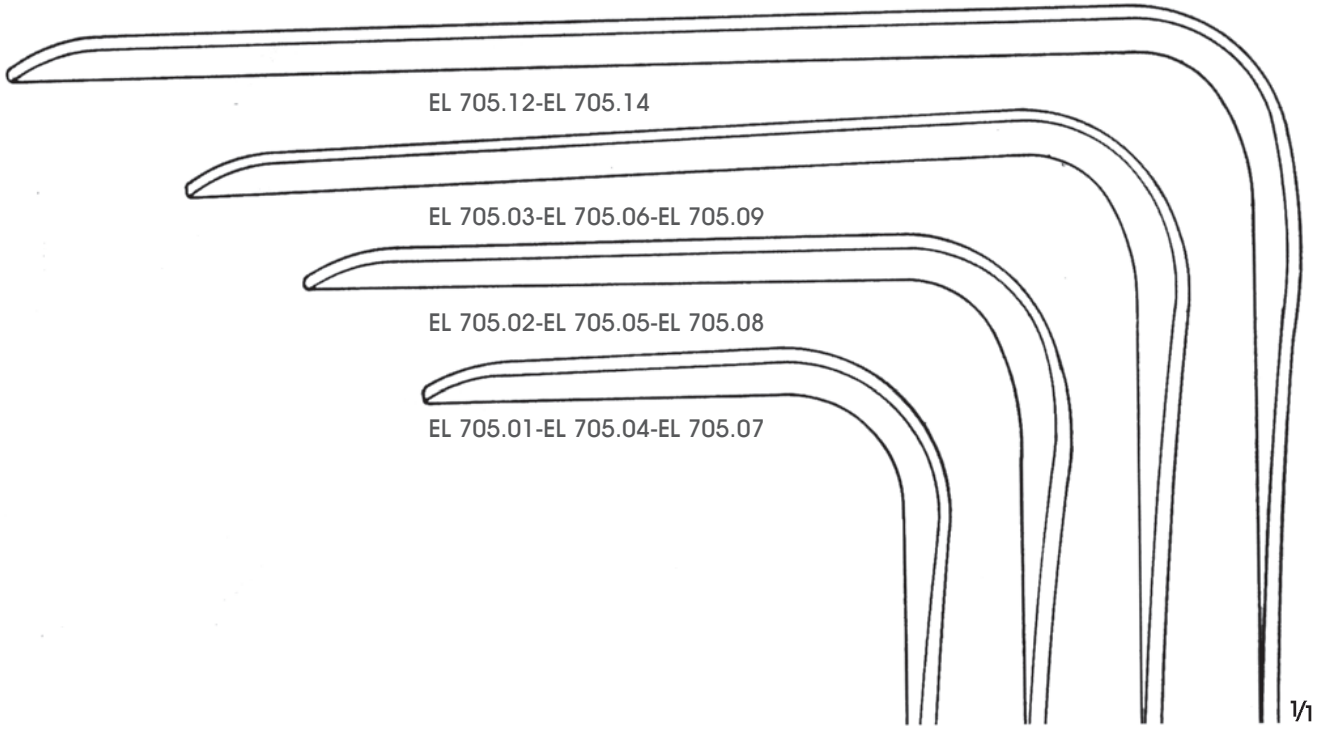

1/2

DOYEN
EL 705.01-EL 705.14
24 cm

Ağız uzunlukları
Length of blades

Ağız genişlikleri
Width of blades

	35 mm	45 mm	60 mm
60 mm	EL 705.01	EL 705.04	EL 705.07
90 mm	EL 705.02	EL 705.05	EL 705.08
120 mm	EL 705.03	EL 705.06	EL 705.09
160 mm	-	EL 705.12	EL 705.14



LANDAU
EL 680.02 100 x 28 mm
EL 680.04 110 x 38 mm
29 cm

1/2



BREISKY
EL 682.02 100 x 20 mm
EL 682.03 100 x 25 mm
EL 682.04 100 x 30 mm
EL 682.05 100 x 35 mm
EL 682.06 100 x 40 mm
Viyana Model
Vienna patterns
30 cm

1/2



BREISKY
EL 683.02 130 x 20 mm
EL 683.03 130 x 25 mm
EL 683.04 130 x 30 mm
EL 683.05 130 x 35 mm
EL 683.06 130 x 40 mm
Viyana Model
Vienna patterns
32 cm

1/2



BREISKY
EL 684.02 160 x 40 mm
EL 684.03 180 x 40 mm
Viyana Model
Vienna patterns
35 cm

1/2





DOYEN
EL 706.01-EL 706.03
23.5 cm

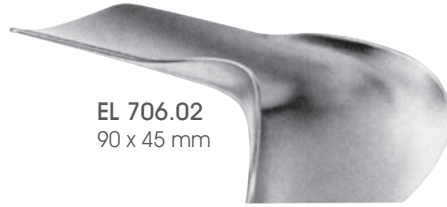
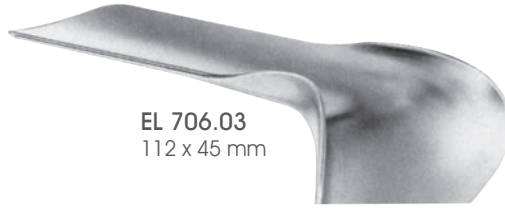

DOYEN
EL 856.01
Yanal spekulum
Lateral speculum
23 cm



DOYEN
EL 857.01
Yanal spekulum
Lateral speculum
25 cm



WEISSBARTH
EL 868.01 80 x 28 mm
EL 868.02 85 x 42 mm
21 cm

K 868.03
Sökülebilir süzgeçli
Removable strainer only

1/2



AUVARD
EL 864.00
65 x 38-28 mm
1.530 gr.
Sökülebilir ağırlıklı
With detachable weight
23 cm

1/2



AUVARD
EL 863.01 75 x 42-40 mm
EL 863.02 105 x 43-40 mm
1.470 gr. sökülebilir ağırlıklı
With detachable weight
23 cm

1/2



AUVARD
EL 862.01
65 x 38-28 mm
1.530 gr.
Sabit ağırlık
Fixed weight
23 cm

1/2

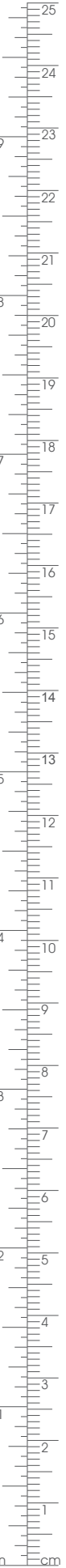

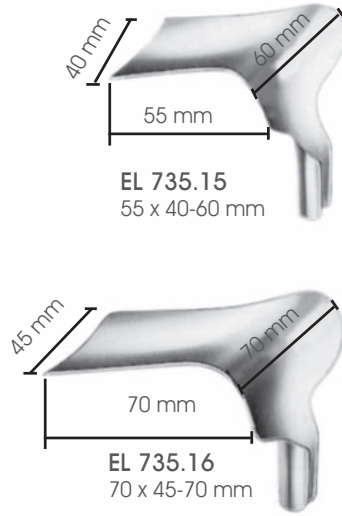

(EL 735.10-EL 735.16 ve EL 735.20-K 735.27) birbirleriyle deđiřtirilebilir.(EL 735.08 ve EL 735.09) saplarına olduđu gibi (EL 735.01)'yada uyar. The mentioned blades (EL 735.10-EL 735.16 and EL 735.20-EL 735.27) can be exchanged. They fit handle EL 735.01 as well as handles EL 735.08 and EL 735.09.

SCHERBACK

EL 791.00 Komple/Complete
(EL 735.01) Sap/Handle
(EL 790.00) Ađırlık/Weight
(EL 735.10-K 735.15)4 Bleyd/4 Blades

1/3

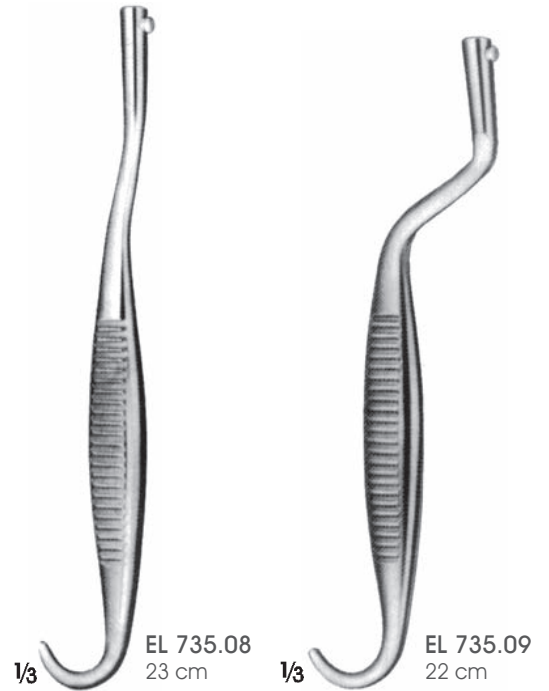

BOZEMANN

EL 735.30 Set/Set
(EL 735.08-K 735.09) 2 Sap/2 Handles
(EL 735.20-K 735.27) 8 Bleyd/8 Blades



GELPI
BV 408.00
13.5 cm

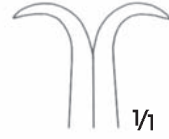

GELPI
BV 409.00
17.5 cm



RICHTER
BV 412.00
17 cm



JOLL (FRIEDMANN)
BV 417.00
15.5 cm





HEGAR
EM 750.01-EM 751.17
Sivri uçlu dilatörler With
very conical point
18.5 cm

EM 750.01	1 mm	EM 750.14	14 mm	EM 751.01	1.5 mm	EM 751.14	14.5 mm
EM 750.02	2 mm	EM 750.15	15 mm	EM 751.02	2.5 mm	EM 751.15	15.5 mm
EM 750.03	3 mm	EM 750.16	16 mm	EM 751.03	3.5 mm	EM 751.16	16.5 mm
EM 750.04	4 mm	EM 750.17	17 mm	EM 751.04	4.5 mm	EM 751.17	17.5 mm
EM 750.05	5 mm	EM 750.18	18 mm	EM 751.05	5.5 mm		
EM 750.06	6 mm	EM 750.19	19 mm	EM 751.06	6.5 mm		
EM 750.07	7 mm	EM 750.20	20 mm	EM 751.07	7.5 mm		
EM 750.08	8 mm	EM 750.21	21 mm	EM 751.08	8.5 mm		
EM 750.09	9 mm	EM 750.22	22 mm	EM 751.09	9.5 mm		
EM 750.10	10 mm	EM 750.23	23 mm	EM 751.10	10.5 mm		
EM 750.11	11 mm	EM 750.24	24 mm	EM 751.11	11.5 mm		
EM 750.12	12 mm	EM 750.25	25 mm	EM 751.12	12.5 mm		
EM 750.13	13 mm	EM 750.26	26 mm	EM 751.13	13.5 mm		



HEGAR
EM 754.01-EM 754.09
19.5 cm

EM 754.01	1 + 2 mm
EM 754.02	3 + 4 mm
EM 754.03	5 + 6 mm
EM 754.04	7 + 8 mm
EM 754.05	9 + 10 mm
EM 754.06	11 + 12 mm
EM 754.07	13 + 14 mm
EM 754.08	15 + 16 mm
EM 754.09	17 + 18 mm



PRATT
EM 756.01-EM 756.08
29 cm

EM 756.01	13 - 15 Charr.
EM 756.02	17 - 19 Charr.
EM 756.03	21 - 23 Charr.
EM 756.04	25 - 27 Charr.
EM 756.05	29 - 31 Charr.
EM 756.06	33 - 35 Charr.
EM 756.07	37 - 39 Charr.
EM 756.08	41 - 43 Charr.

EM 790.00

Set (EM 750.04-J 750.17) 14 parça
Set (EM 750.04-J 750.17) 14 piece
EM 310.10WV 1 adet, EM 380.03F 1 adet, EM 840.00 15 adet, EM 841.01 1 adet, EM 842.00 2 adet dahildir.
With EM 310.10WV 1 each, EM 380.03F 1 each, EM 840.00 15 each, EM 841.01 1 each, EM 842.00 2 each.

EM 790.01

Set (EM 751.04-EM 751.17) 14 parça
Set (EM 751.04-EM 751.17) 14 piece
EM 310.10WV 1 adet, EM 380.03F 1 adet, EM 840.00 15 adet, EM 841.01 1 adet, EM 842.00-2 adet dahildir.
With EM 310.10WV 1 each, EM 380.03F 1 each, EM 840.00 15 each, EM 841.01 1 each, EM 842.00 2 each.

EM 792.00

Tam set 28 parça/Full set 28 piece
Set (EM 750.04-EM 750.17)+(EM 751.04-EM 751.17)
EM 110.10WV 1 adet, EM 181.05F 1 adet, EM 840.00 31 adet, EM 841.01 1 adet, EM 842.01 2 adet dahildir.
With EM 110.10WV 1 each, EM 181.05F 1 each, EM 380.03F 1 each, EM 840.00 15 each, EM 841.01 1 each, EM 842.00 2 each.

JG 841.00 230 mm
JG 841.01 470 mm
JG 840.00 bölücü için sürgülü ray, güvenlik vidaları ile
Sliding rails with securing screws, for divider JG 840.00

JG 842.00 230 mm
JG 842.01 470 mm
Sınırlayıcı kalıp, güvenlik vidaları ile özellikle depolama dilatörleri için uygun
Limiting bars with securing screws, particularly useful for storing dilators

JG 840.00
Bölücü, JG 841.00 için
Divider, to be used with JG 841.00

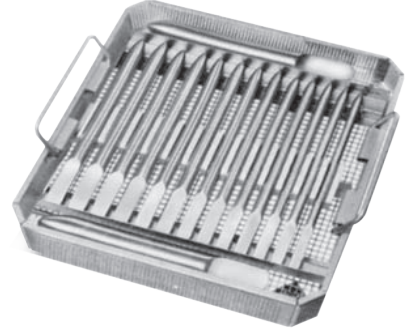

Konteyner/Container



JG 310.10WV 285 x 280 x 100 mm
JG 310.13WV 285 x 280 x 135 mm
JG 310.15WV 285 x 280 x 150 mm
JG 310.20WV 285 x 280 x 200 mm
JG 310.26WV 285 x 280 x 260 mm

Konteyner/Container



JG 110.10WV 580 x 280 x 100 mm
JG 110.13WV 580 x 280 x 135 mm
JG 110.15WV 580 x 280 x 150 mm
JG 110.20WV 580 x 280 x 200 mm
JG 110.26WV 580 x 280 x 260 mm

Tel sepetler/Wire baskets



JG 380.03F 242 x 252 x 40 mm
JG 380.05F 242 x 252 x 60 mm
JG 380.07F 242 x 252 x 80 mm
JG 380.10F 242 x 252 x 110 mm

Tel sepetler/Wire baskets



JG 181.03F 539 x 252 x 40 mm
JG 181.05F 539 x 252 x 60 mm
JG 181.07F 539 x 252 x 80 mm
JG 181.10F 539 x 252 x 110 mm

Tel taban/Wire Base



JG 393.00 258 x 258 x 30 mm

Tel taban/Wire Base



JG 193.00 545 x 255 x 30 mm

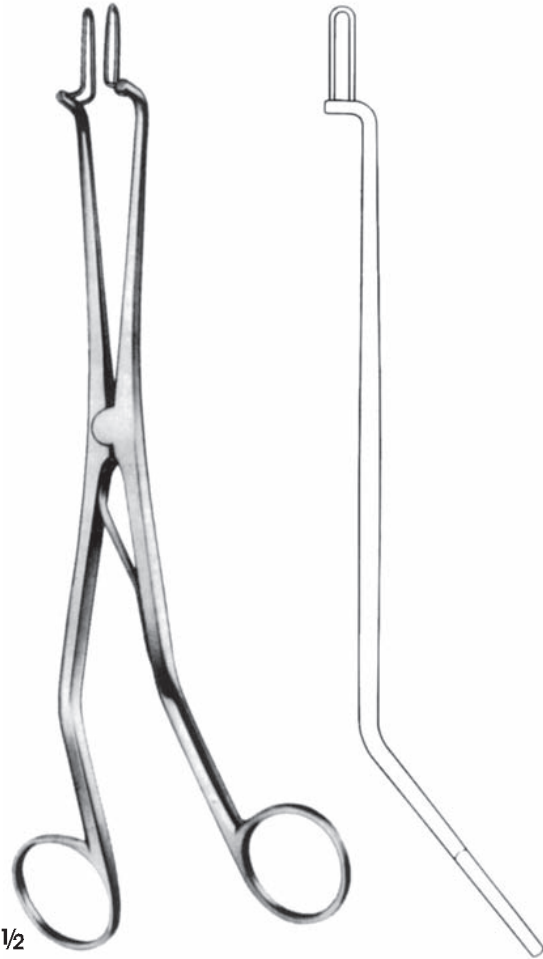

KOGAN
EM 400.01
Kilitsiz/Without ratchet
24 cm

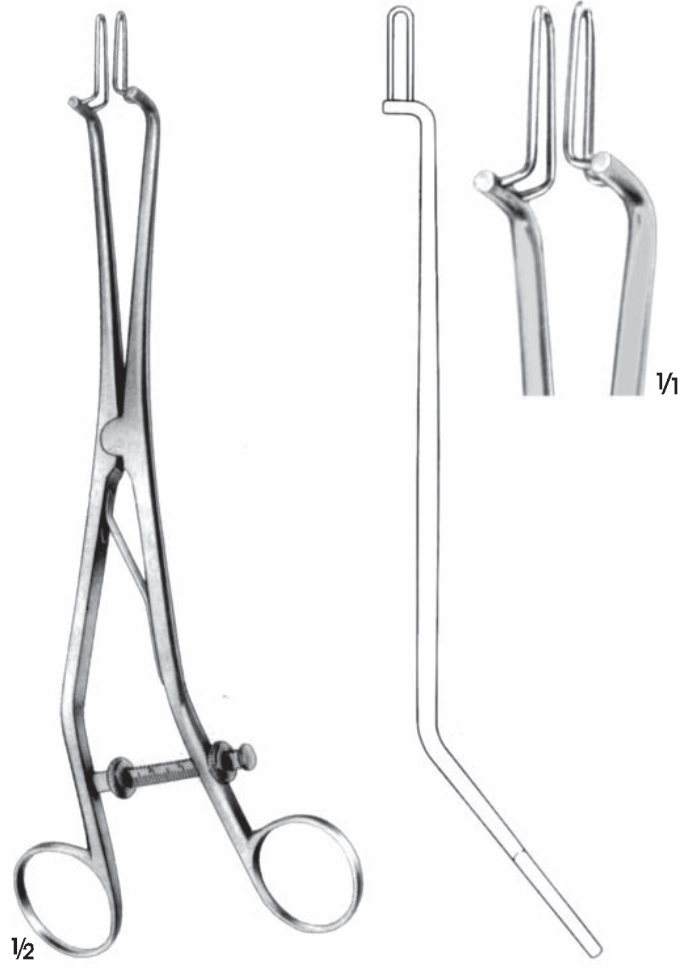

KOGAN
EM 401.01
Ölçülü sabitleyici ayar vidası
With scale-ratchet and fixing screw
24 cm



Ø 5 mm



1/2

MAYO
EO 650.05
Bükülebilir/Malleable
33 cm

Ø 4 mm



1/2

SIMS
EO 652.05 33 cm
EO 652.08 33 cm
Bükülebilir/Malleable

Ø 3 mm



1/2

EO 653.05
30 cm

Ø 4 mm



1/2

SIMPSON
EO 656.05
Bükülebilir, gümüş kaplama
Malleable, silver-plated
31 cm

Ø 3.6 mm



1/2

**GALABINS
EO 654.00**
Ölçütü mil, bükülebilir
Shaft graduated in cm, malleable
29.5 cm

Ø 4 mm



1/2

**VALLEIX
EO 658.05**
Ölçü kaydırıcı, göstergeli
Graduated, with slider
25 cm

24 mm



1/2

**BRAUN
EO 390.03**
Uterin bastırıcı
Uterine depressor
27 cm







BOZEMANN
EO 364.02-EO 365.02



EO 364.02
26 cm



EO 365.02
25 cm

1/1



BOZEMANN-DOUGLAS
EO 367.02
26 cm

1/2

1/1

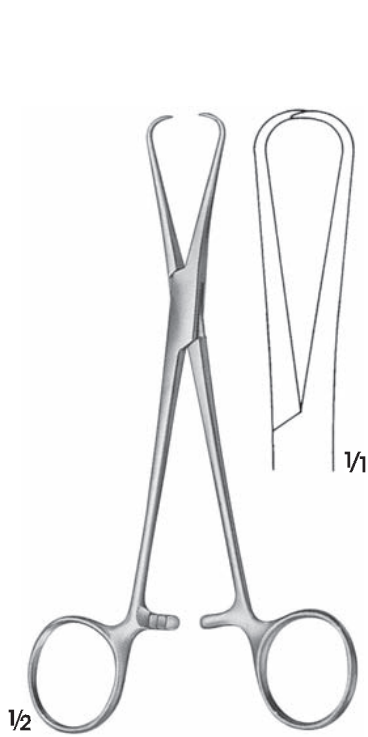

BERNHARD
 BF 444.00
 16 cm



POZZI
 EO 445.01
 17.5 cm

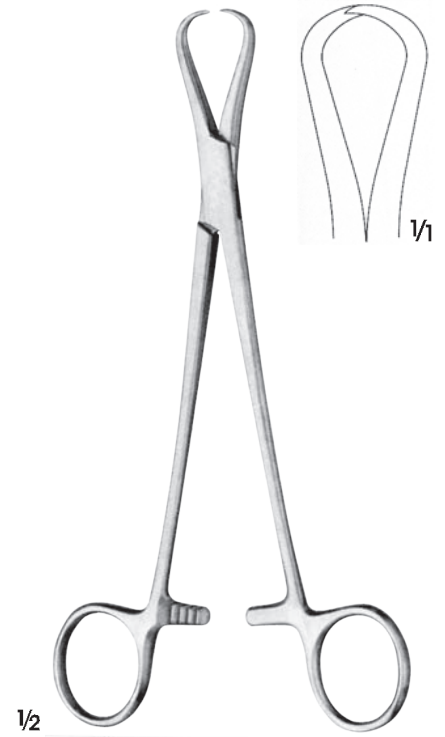

ADAIR
 BF 443.00
 19 cm



BRAUN
 EO 258.01
 Narin Model/Slender pattern
 25 cm

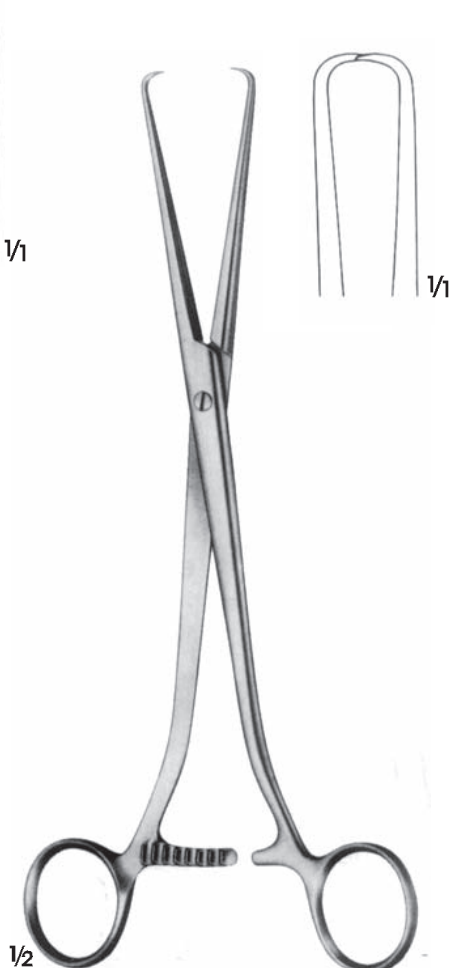

COLLIN-POZZI
 EO 270.01
 25 cm

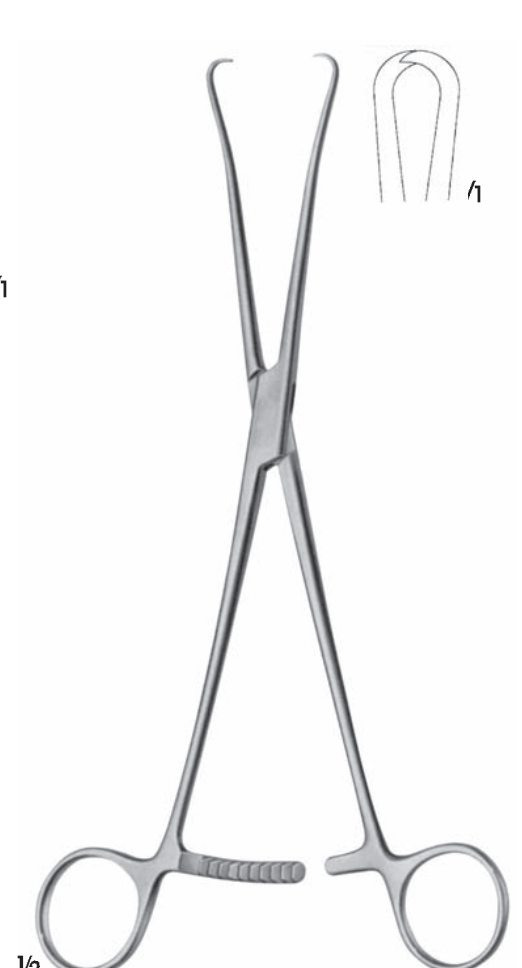

WILSON
 EO 252.00
 24 cm



1/1



1/1



1/1



1/2

SCHRÖDER
EO 251.00
Standart Model
Standart pattern
25 cm



1/2

SCHRÖDER
EO 253.01
25 cm



1/2

POZZI
EO 255.01
Zorlu operasyon için
Heavy pattern
25.5 cm



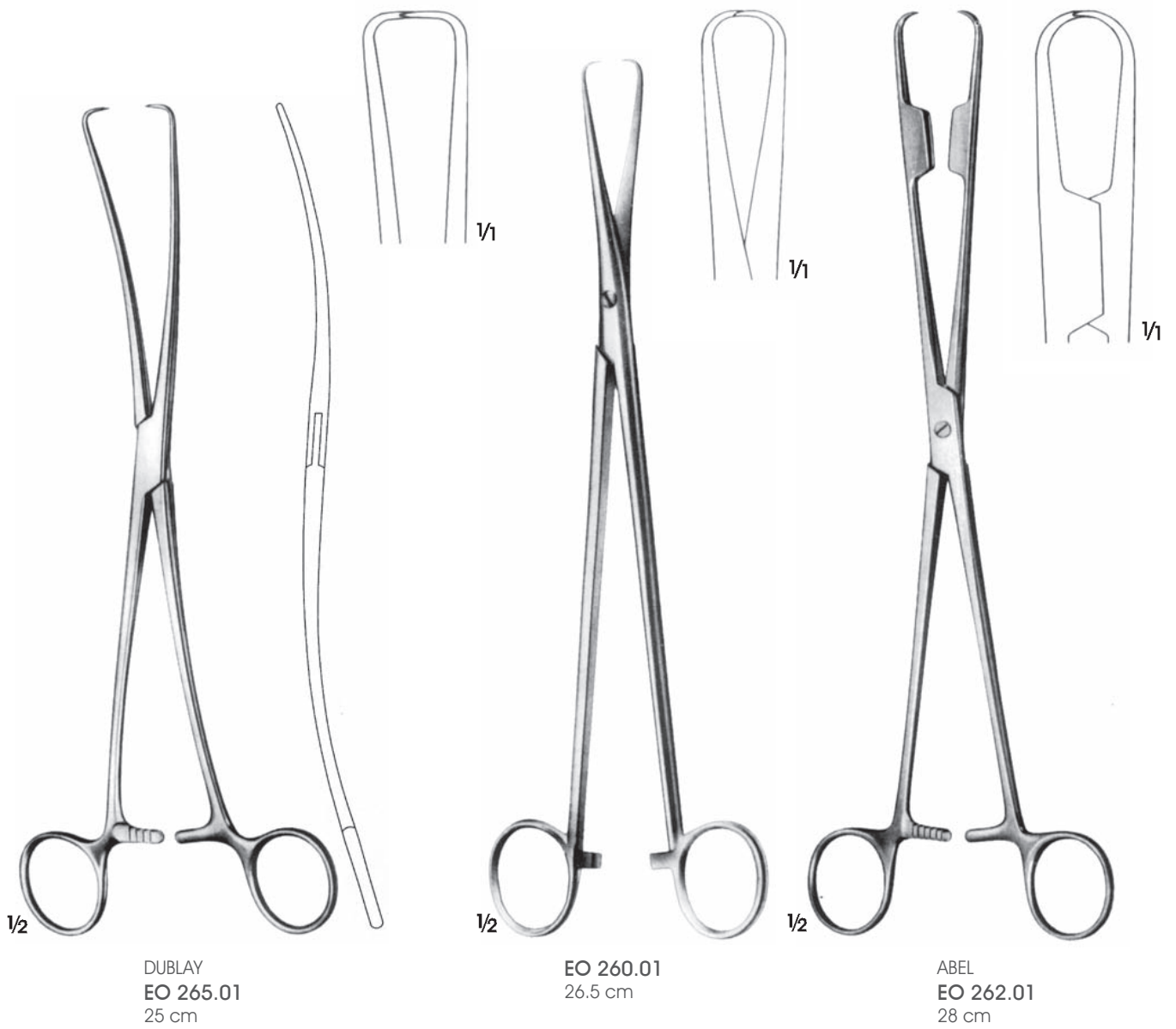



MUSEUX
 EO 375.01
 20 cm



JACOBS
 EO 376.01
 21.5 cm



MUSEUX
 EO 380.02-EO 380.04
 24 cm



MUSEUX
 EO 381.02-EO 381.04
 26.5 cm

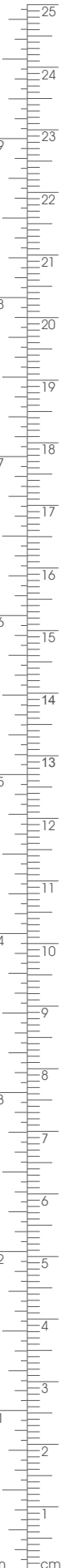

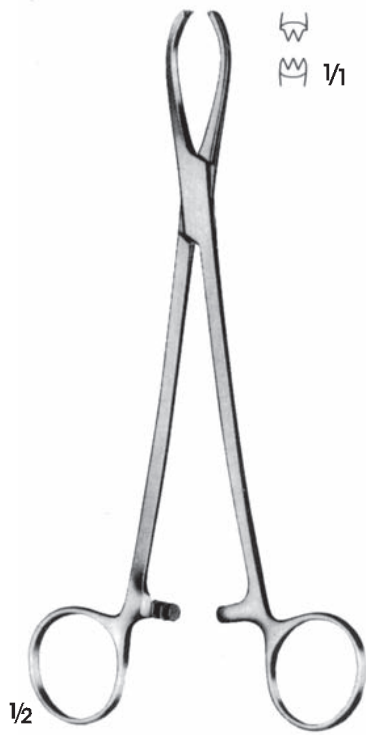

LITTLEWOOD
EO 378.02
18.5 cm



TEALE
EO 379.02
22.5 cm



MUSEUX
EO 382.02-EO 382.04
Yana eđri
Curved to side
24 cm



KÜSTNER
EO 383.02
25 cm

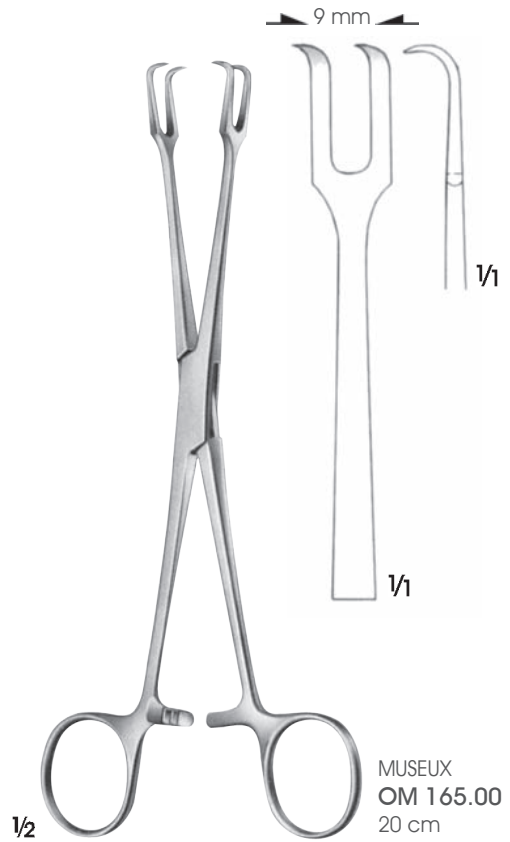
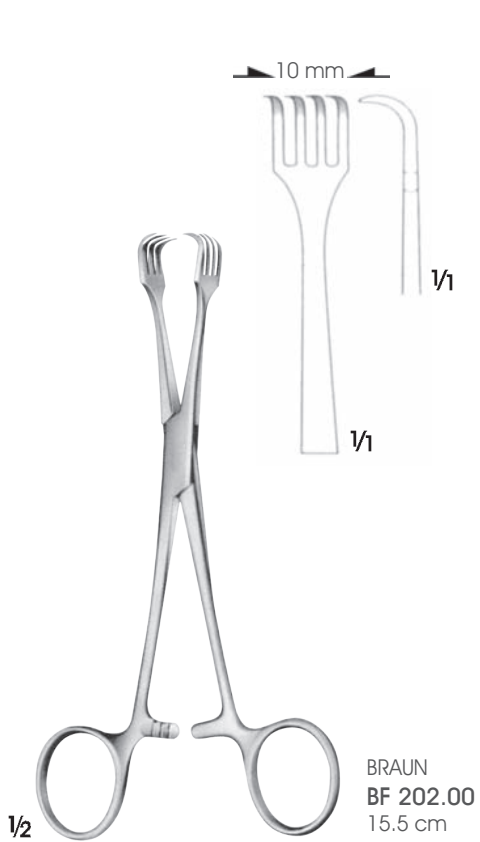
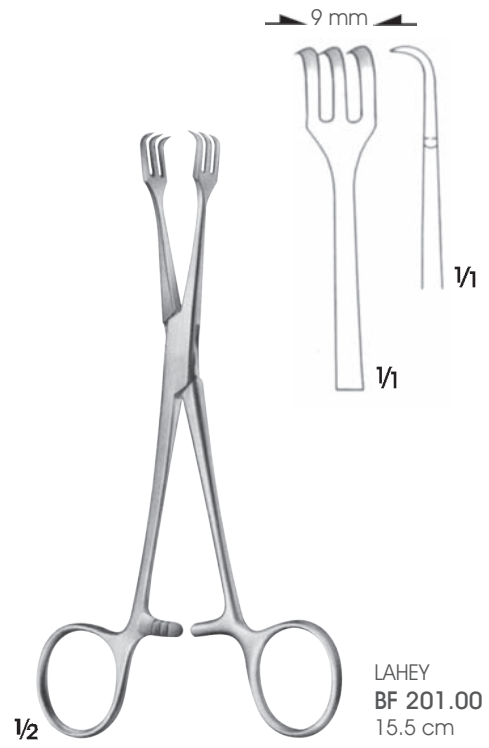
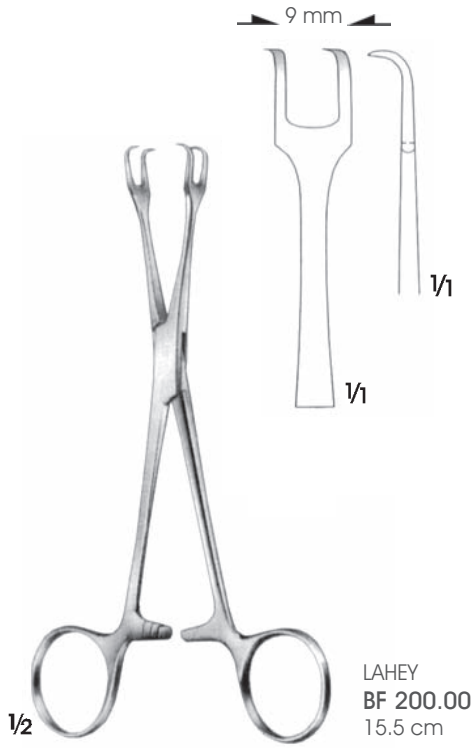

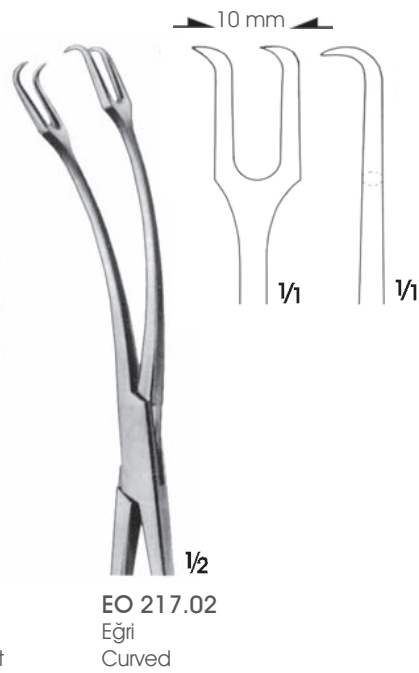
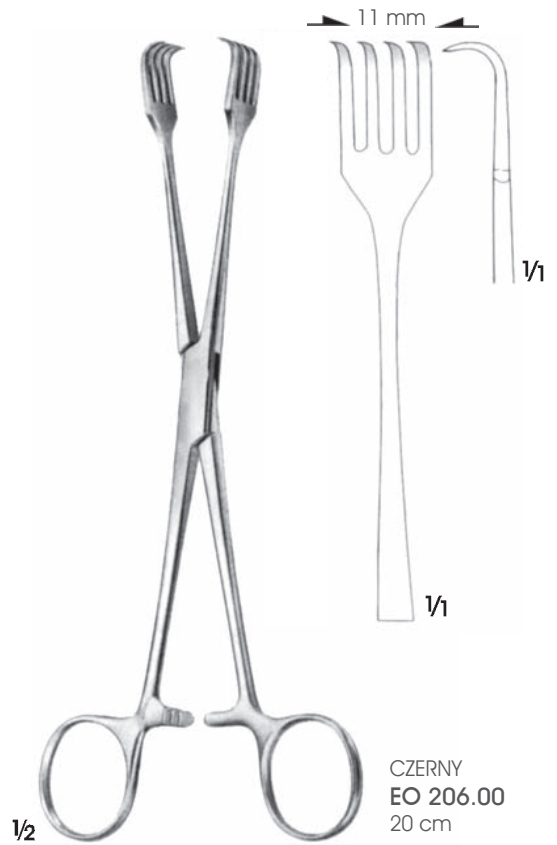
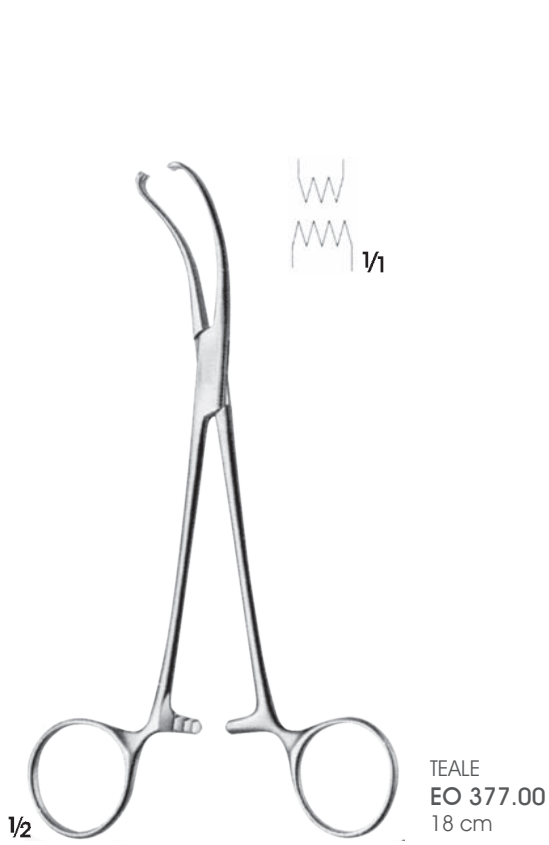

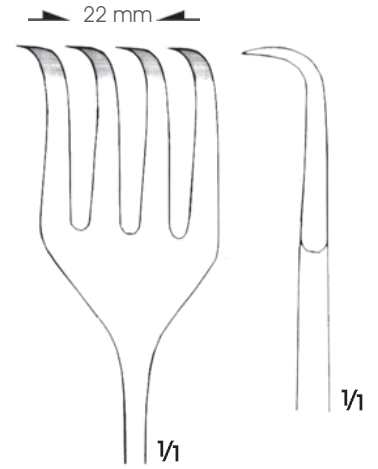
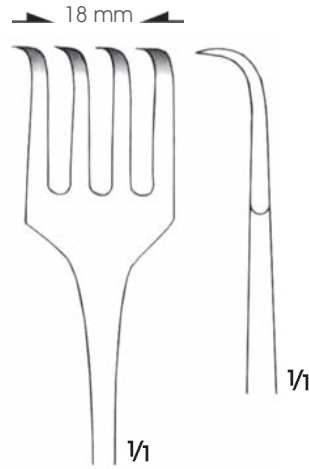
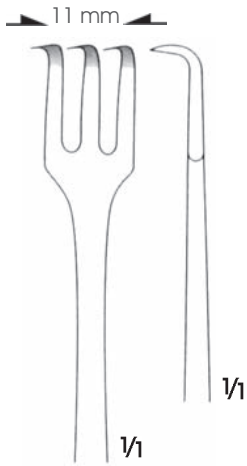

SCHRÖDER
EO 208.00
27 cm



PRATT
EO 210.00
26 cm



PRATT
EO 211.00
27 cm

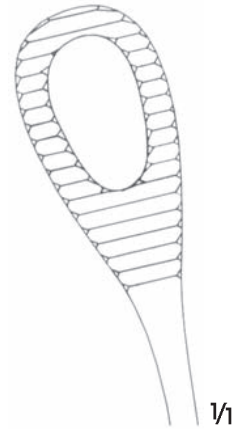

1/2

HEYWOOD-SMITH
EO 198.00
25 cm

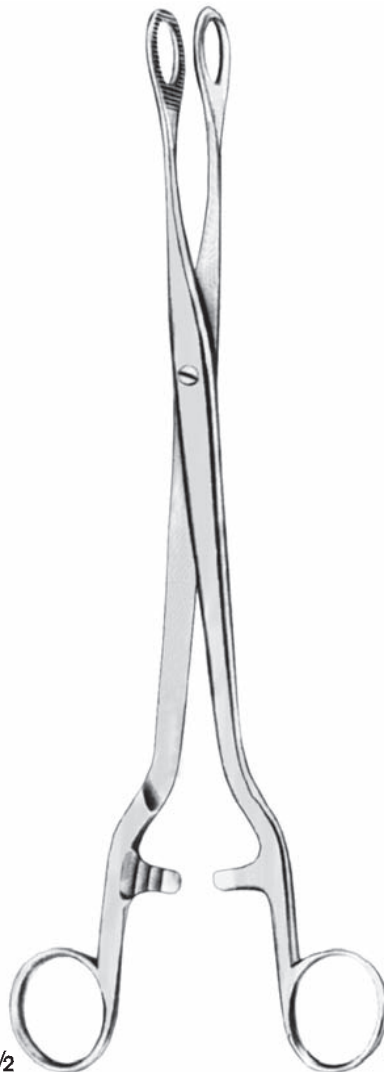

1/2

NOTO
EO 120.00
28 cm

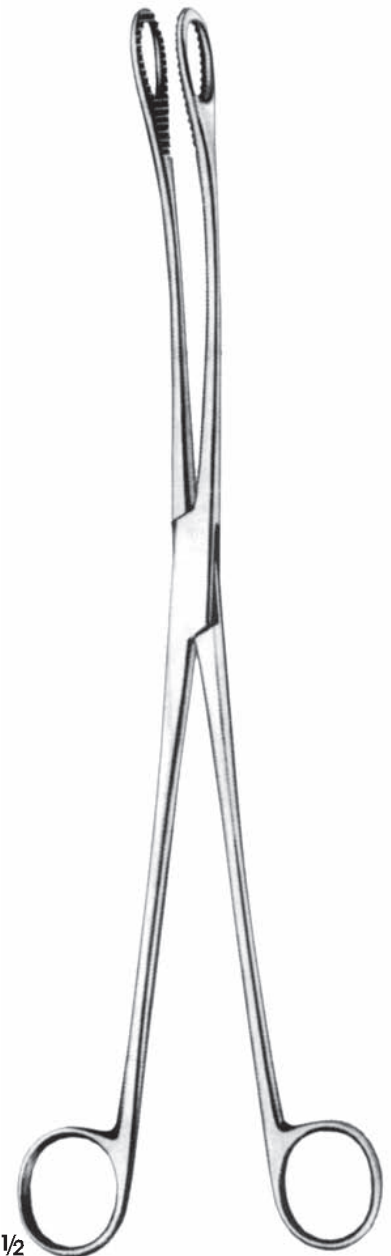

1/2

KELLY
BF 122.00
32 cm

Atromatik
Atraumatic

21 mm

27 mm

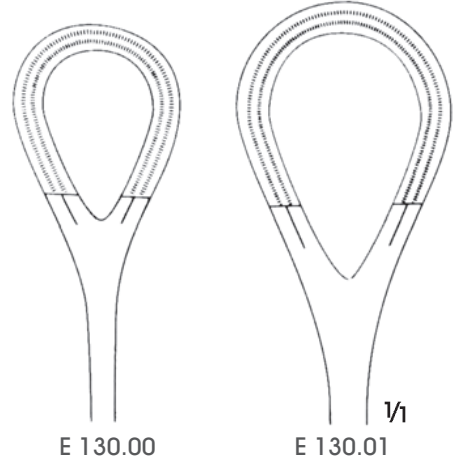

1/2

HEYWOOD-SMITH
AN 190.00
20 cm



1/2

DOYEN
EO 196.00
18.5 cm



EO 130.00 25 cm
EO 130.01 27 cm





1/2
SOMER
EO 560.01
23.5 cm



1/2
DARTIGUES
EO 575.02
25.5 cm



Hareketli çeneli
With movable jaws

1/2
COLLIN
EO 550.01
26.5 cm

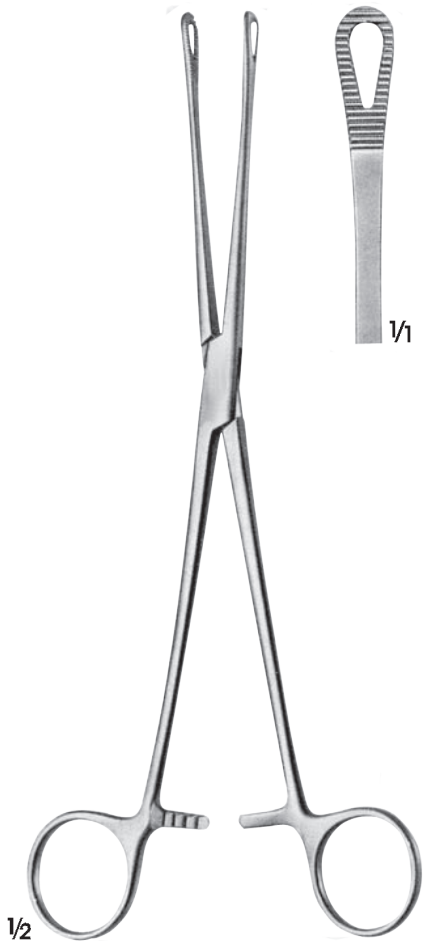

BONNEY
EO 088.00
24 cm



COLLIN
EO 570.01
25 cm



COLLIN
EO 577.02
28.5 cm



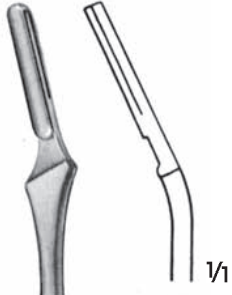

1/1

BB 034.01
Açılı bistüri sapı
Scalpel handle, angular curved
22.5 cm



1/2

DOYEN
EO 420.00
Myoma burgusu
Myoma screw
15 cm



1/2

DOYEN
EO 421.00
Myoma burgusu
Myoma screw
19 cm

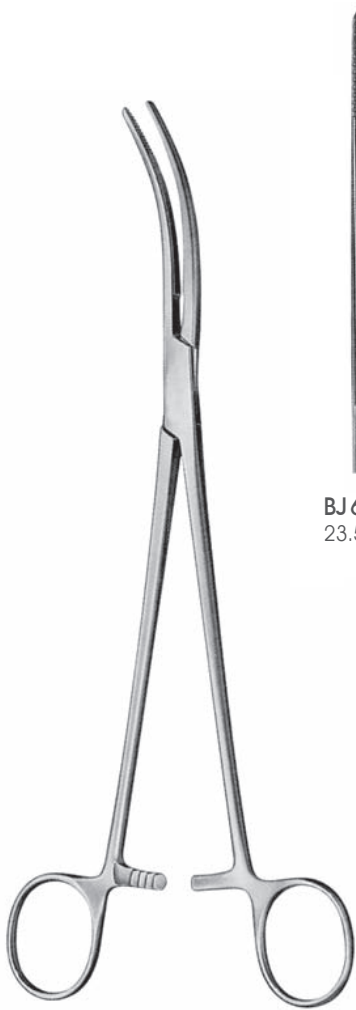

BJ 675.00
23.5 cm



BJ 675.02
35 cm

1/1

KEIBACK
BJ 675.00 23.5 cm
BJ 675.02 35 cm
Yan kavisli üretral tünel pensleri
Ureteral tunnel clamps, curved to side



UCHIDA
ET 428.00 27 cm
ET 428.03 35 cm
Kaşıklar/Spoons





KIEBACK
BC 614.00-BC 614.02
Parametrium makaslar
Parametrium scissors

KEIBACK
BC 615.00-BC 615.02
Parametrium makaslar
1 bleydi küre uclu, yana eğri
Parametrium scissors, curved to side,
with 1 probe pointed blade

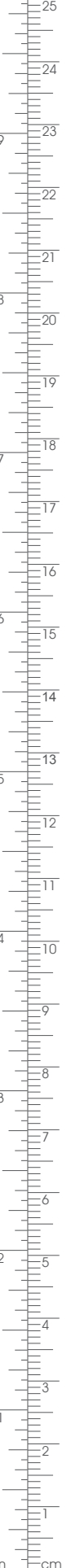

BURKE
BJ 775.00-BJ 775.02
Parametrium pensler, kısa ağızlı
Parametrium clamps, short jaw part



BURKE
BJ 776.00-BJ 776.02
Parametrium pensler, uzun ağızlı
Parametrium clamps, long jaw part

Bükülebilir
Malleable



ASCH
ER 585.01
Kaşık/Scoop
20 cm



RANDALL
ER 580.02
Biyopsi küreti
Biopsy curette
24 cm



NOVAK-SCHOECKAERT
ER 581.02
Biyopsi küreti
Biopsy curette
24 cm



BERLIN
ER 595.04
Biyopsi küreti
Biopsy curette
27 cm



MÜNCHEN
ER 595.05
Biyopsi küreti
Biopsy curette
27 cm

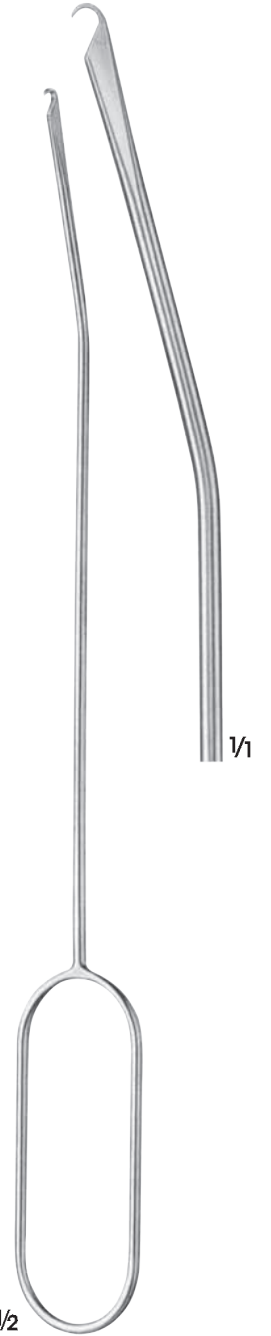

SAUNDERS
ER 598.00
Çıkarma huk
Removing hook
32 cm

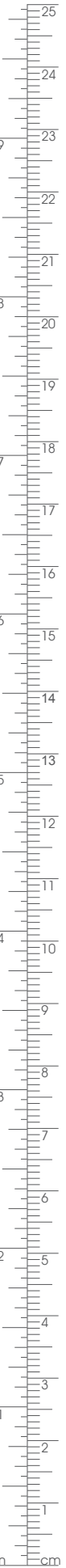
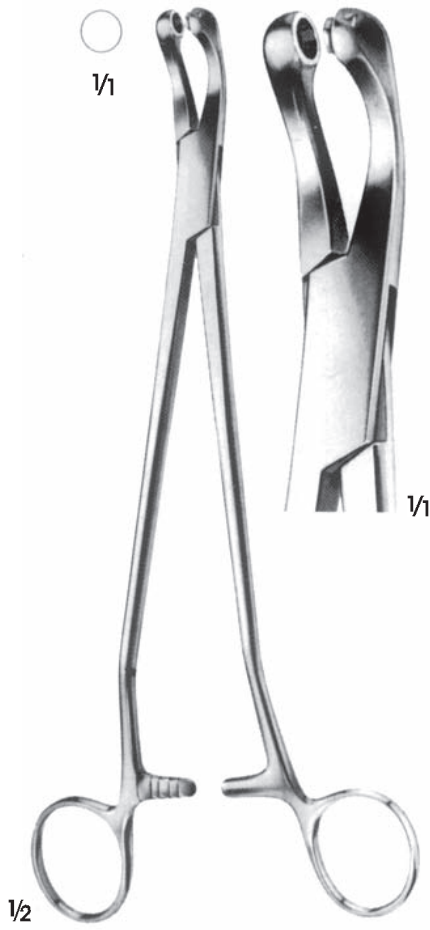

Çengel ağız ile daha güvenilir tutuş sağlar.
Ağız geniş açılabilir.
Düzgün ve uygun kesme sağlar.
Deforme olmamış ezilmemiş parça alınmasına imkan verir.
Travma'ya neden olmaması nedeni ile iyileşme çabuk olur.
More reliable grip on the tissue due to 'hooking' effect.
Wide angle of opening.
Smooth, steady cut.
Specimens are not squashed.
Not painful; self-wound, heals well.

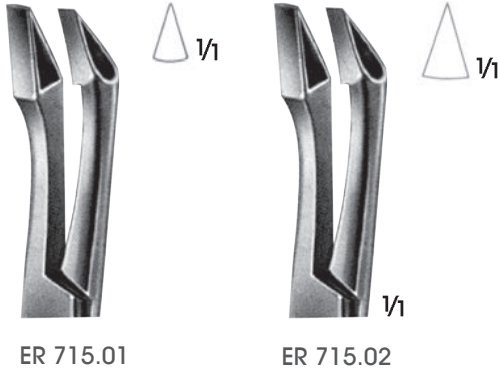

SCHUMACHER
ER 715.01-ER 715.02
24 cm

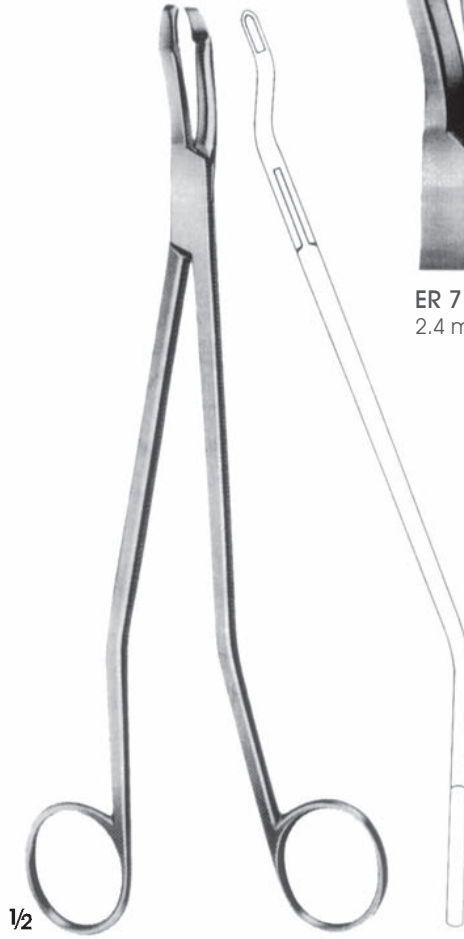
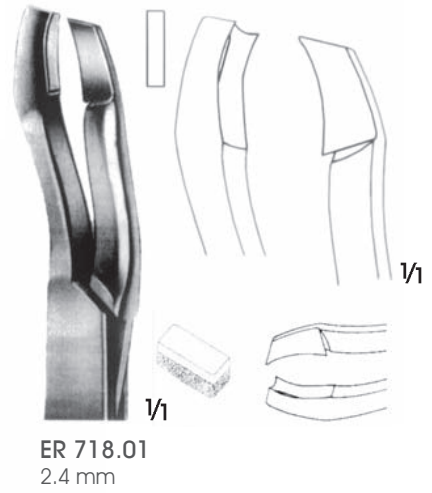
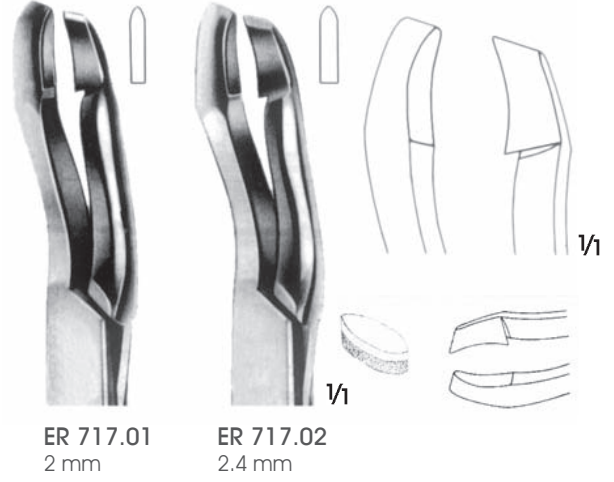

SEIDL DBP
ER 717.01-ER 718.01
Bayonet biyopsi pensleri Bayonet-
Shaped biopsy forceps 24 cm

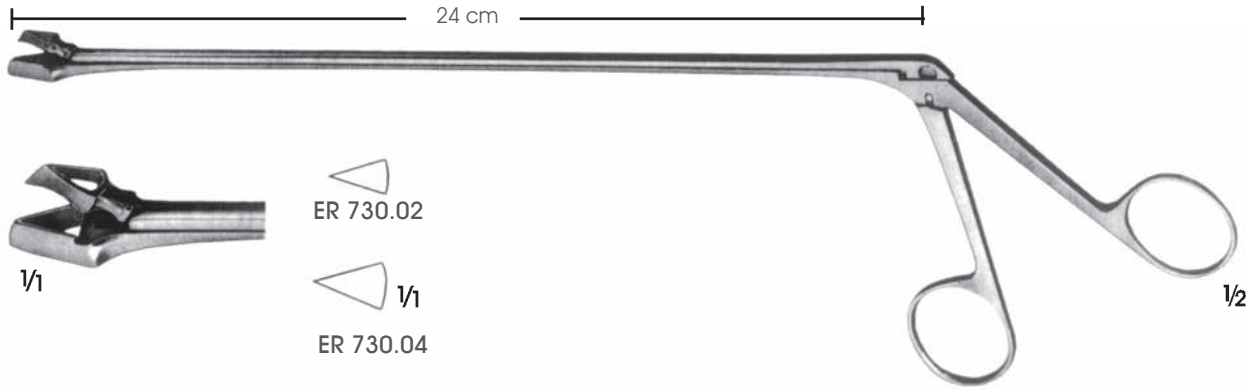

SCHUMACHER
ER 730.02-ER 730.04
Kolkoskopi için uygun
Suitable for colposcopy
24 cm



EPPENDORF
ER 732.02
Kolkoskopi için uygun
Suitable for colposcopy
20 cm



BERGER
ER 734.02
21 cm



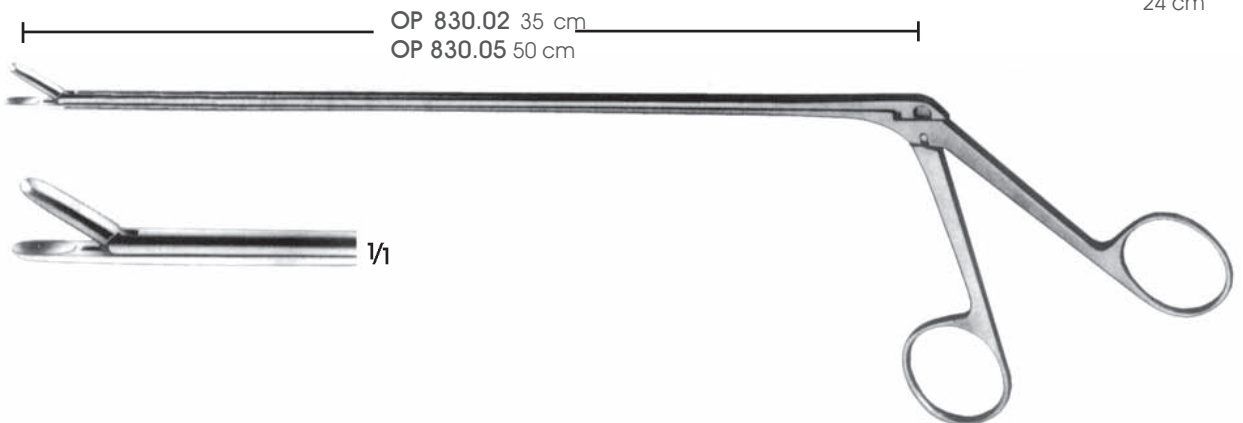
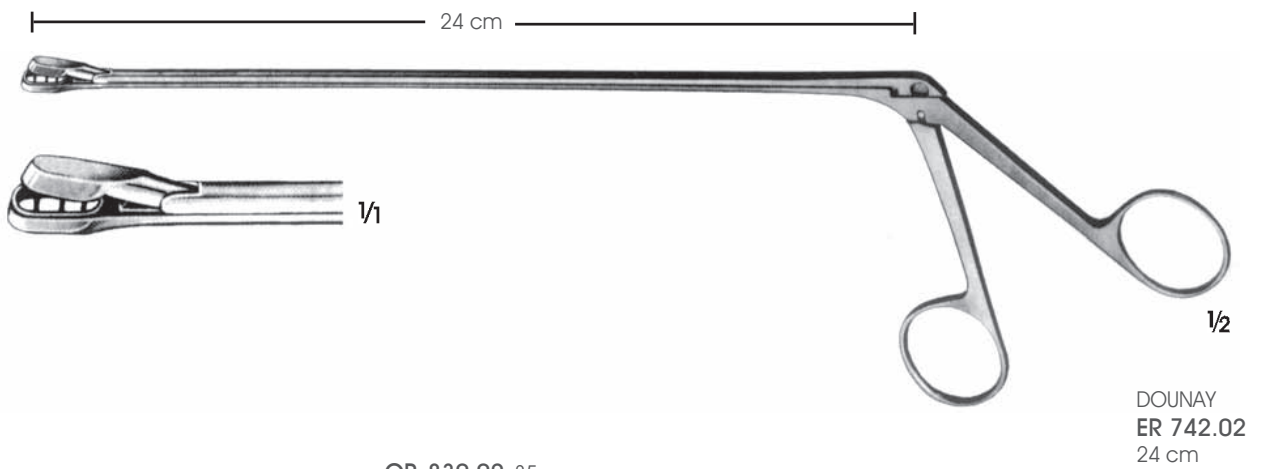
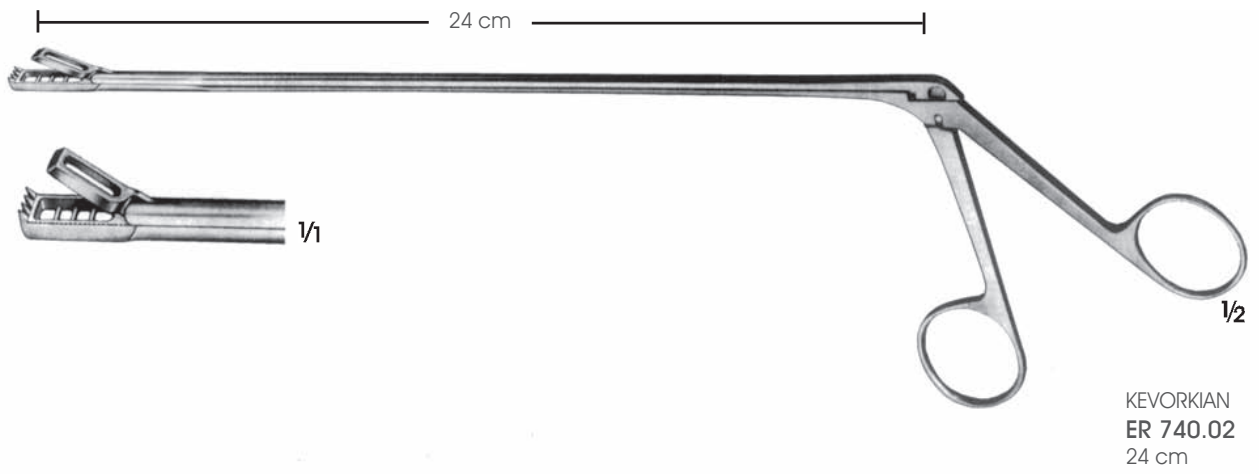
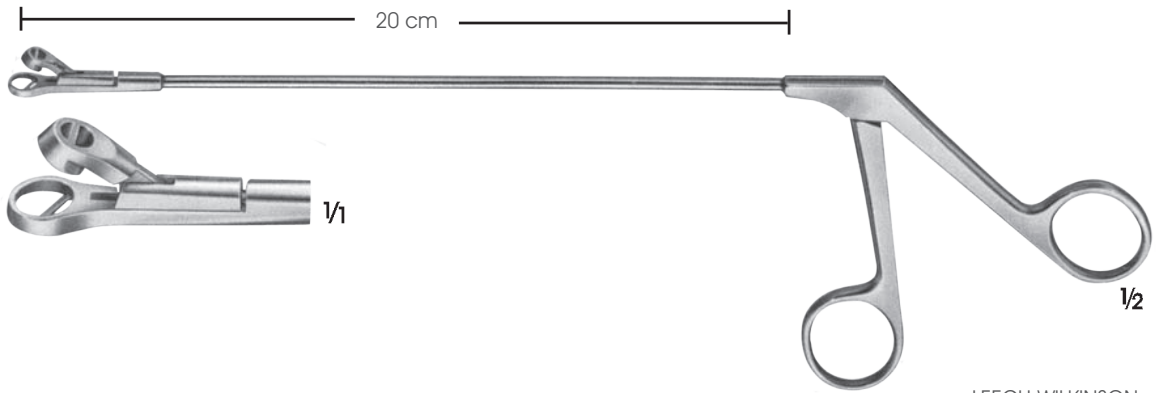

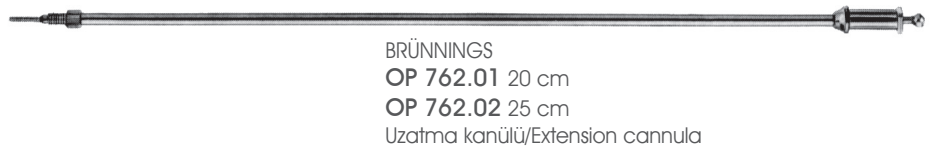
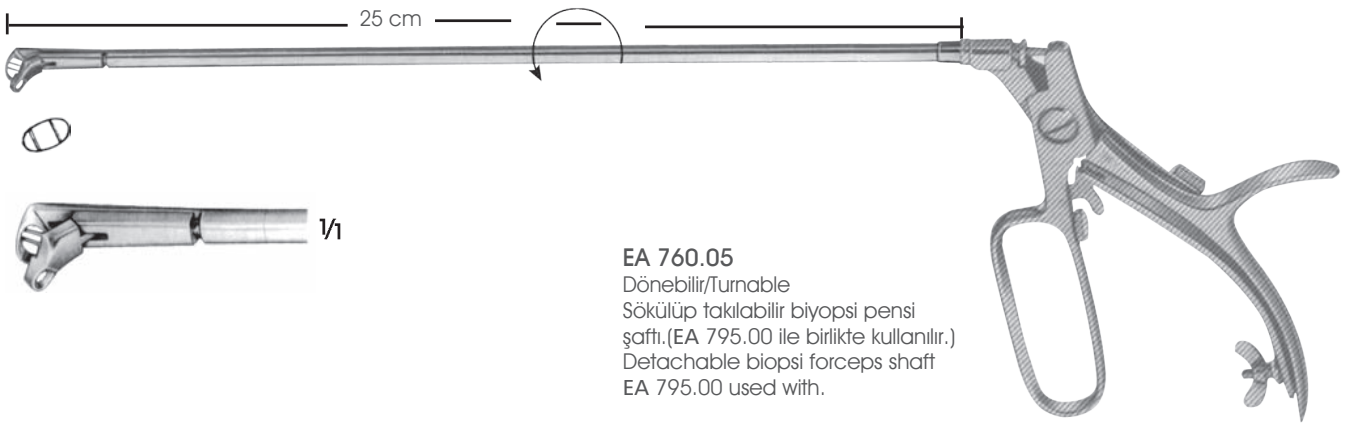
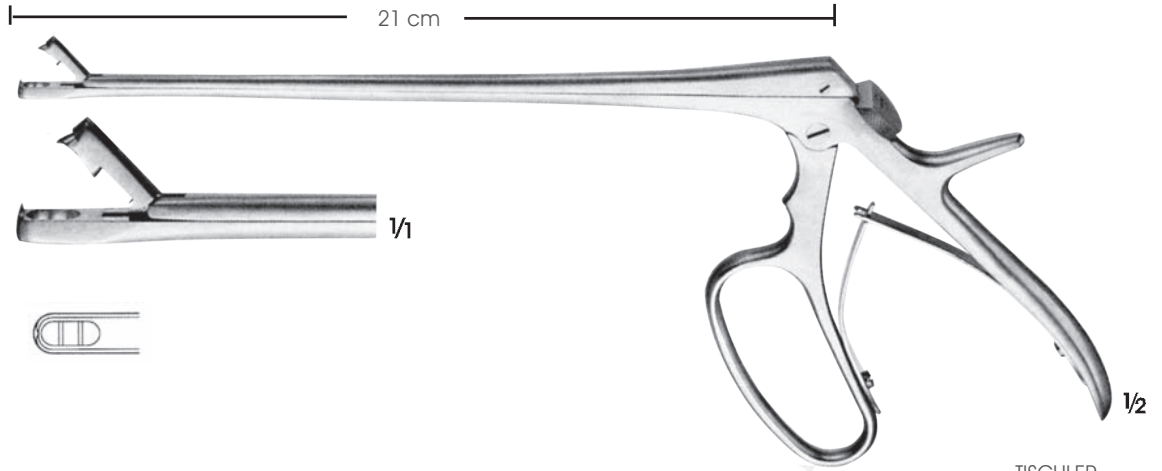

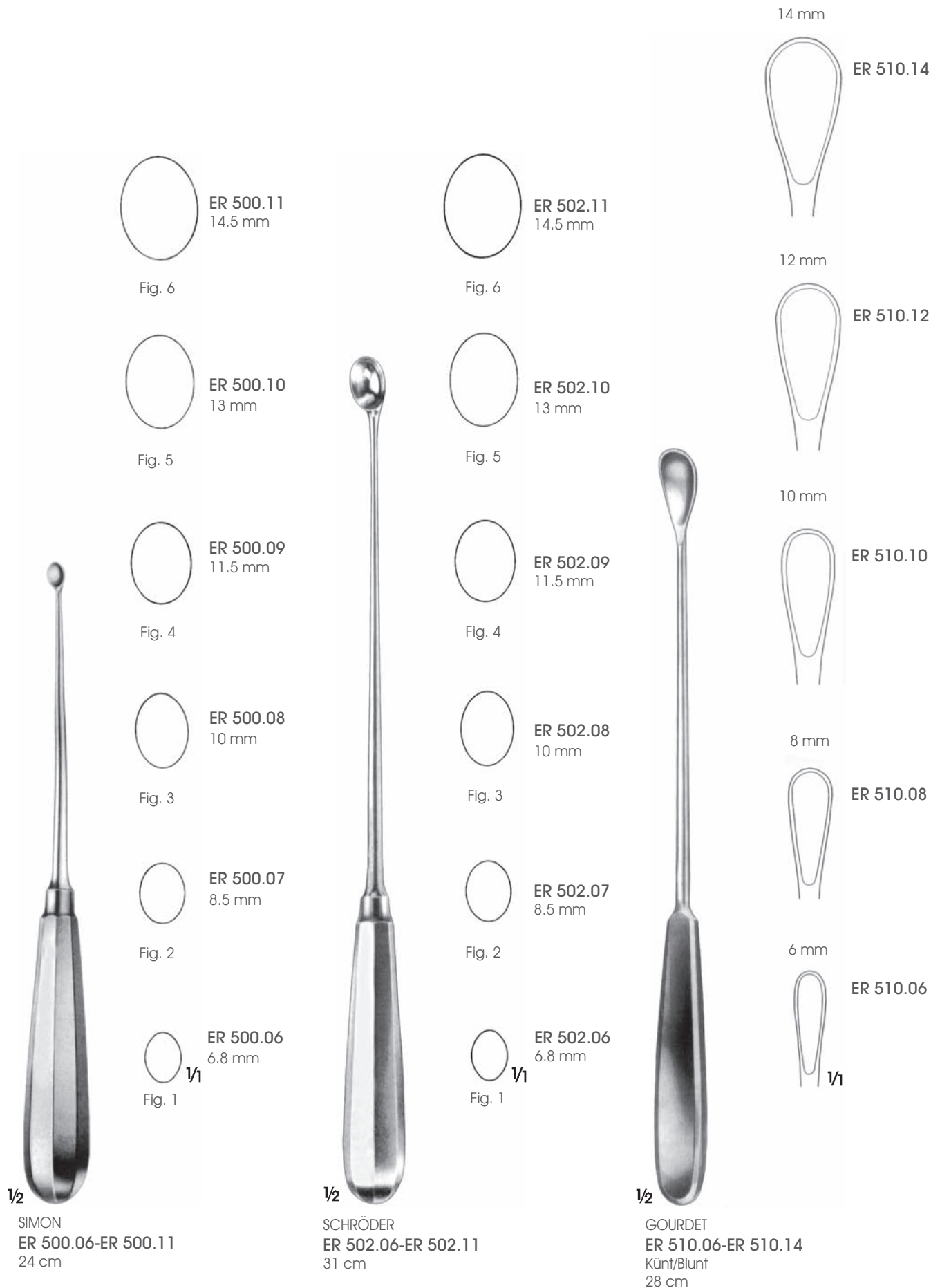



RECAMIER
ER 520.04-ER 520.38
Sivri-Rijid/Sharp-Rigid
ER 525.09-ER 525.30
Sivri-Bükülebilir/Sharp-Malleable
ER 528.08-ER 528.38
Künt-Rijid/Blunt-Rigid
30 cm



ER 520.34
ER 528.34
21.5 mm

Fig. 9



ER 520.27
ER 525.27
ER 528.27
18 mm

Fig. 7



ER 520.21
ER 525.21
ER 528.21
15 mm

Fig. 5



ER 520.15
ER 525.15
ER 528.15
12 mm

Fig. 3



ER 520.09
ER 525.09
ER 528.09
8.5 mm

Fig. 1



ER 520.04
4.5 mm

Fig. 00

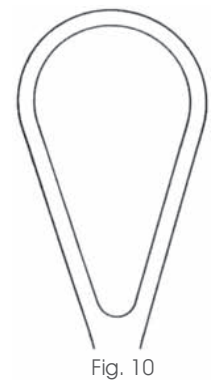

ER 520.38
ER 528.38
23.5 mm

Fig. 10



ER 520.30
ER 525.30
ER 528.30
19.5 mm

Fig. 8



ER 520.24
ER 525.24
ER 528.24
16.5 mm

Fig. 6



ER 520.19
ER 525.19
ER 528.19
14 mm

Fig. 4



ER 520.12
ER 525.12
ER 528.12
10.5 mm

Fig. 2



ER 520.08
ER 528.08
7.5 mm

Fig. 0

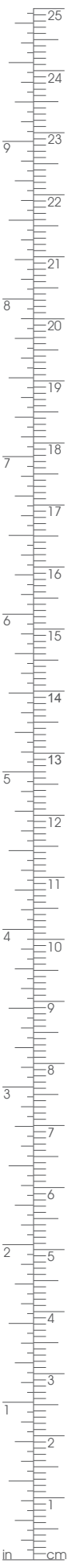



ER 530.21
ER 532.21
ER 534.21
15 mm

Fig 6

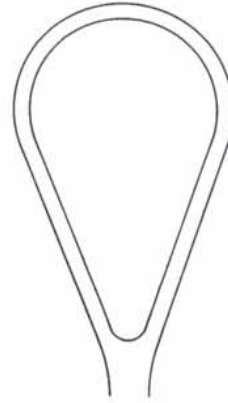

ER 540.41
28.5 mm

Fig 6



ER 530.19
ER 532.19
ER 534.19
14 mm

Fig 5

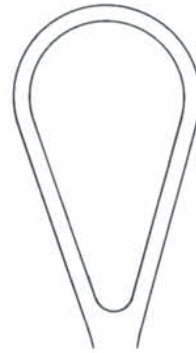

ER 540.31
23.5 mm

Fig 4

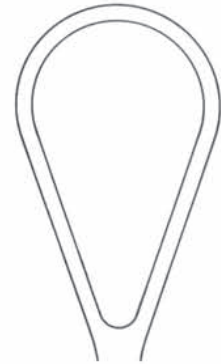

ER 540.36
26 mm

Fig 5



ER 530.15
ER 532.15
ER 534.15
12 mm

Fig 4



SIMS
ER 530.07-ER 530.21
Sivri-Rijid/Sharp-Rigid
ER 532.07-ER 532.21
Sivri-Bükülebilir/Sharp-Malleable
ER 534.07-ER 534.21
Künt-Rijid/Blunt-Rigid
25.5 cm

1/2



ER 540.23
19.5 mm

Fig 2



ER 540.27
21.5 mm

Fig 3



ER 530.12
ER 532.12
ER 534.12
10.5 mm

Fig 3



ER 530.09
ER 532.09
ER 534.09
8.5 mm

Fig 2



ER 530.07
ER 532.07
ER 534.07
7.5 mm

Fig 1



ER 540.16
16 mm

Fig. 0



ER 540.20
18 mm

Fig. 1

BUMM
ER 540.16-ER 540.41
Künt-Bükülebilir/Blunt-Malleable
29 cm

1/2



1/2

RECAMIER
ER 550.34-ER 550.44
Künt-Rijid/Blunt-Rigid 36
cm

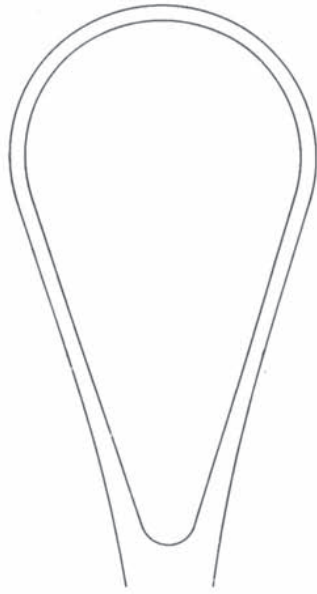

Fig. 2

ER 550.44
39.5 mm

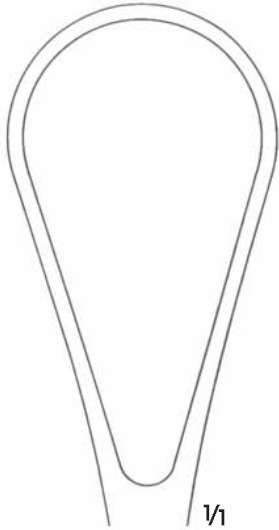

Fig. 1

ER 550.34
34.5 mm

1/1



Fig. 3

ER 552.35
ER 554.35
28.5 mm



1/2

BUMM
ER 552.24-ER 552.35
Sivri-bükülebilir/Sharp-malleable
ER 554.24-ER 554.35
Künt-bükülebilir/Blunt-malleable
31 cm



Fig. 2

ER 554.30
26 mm

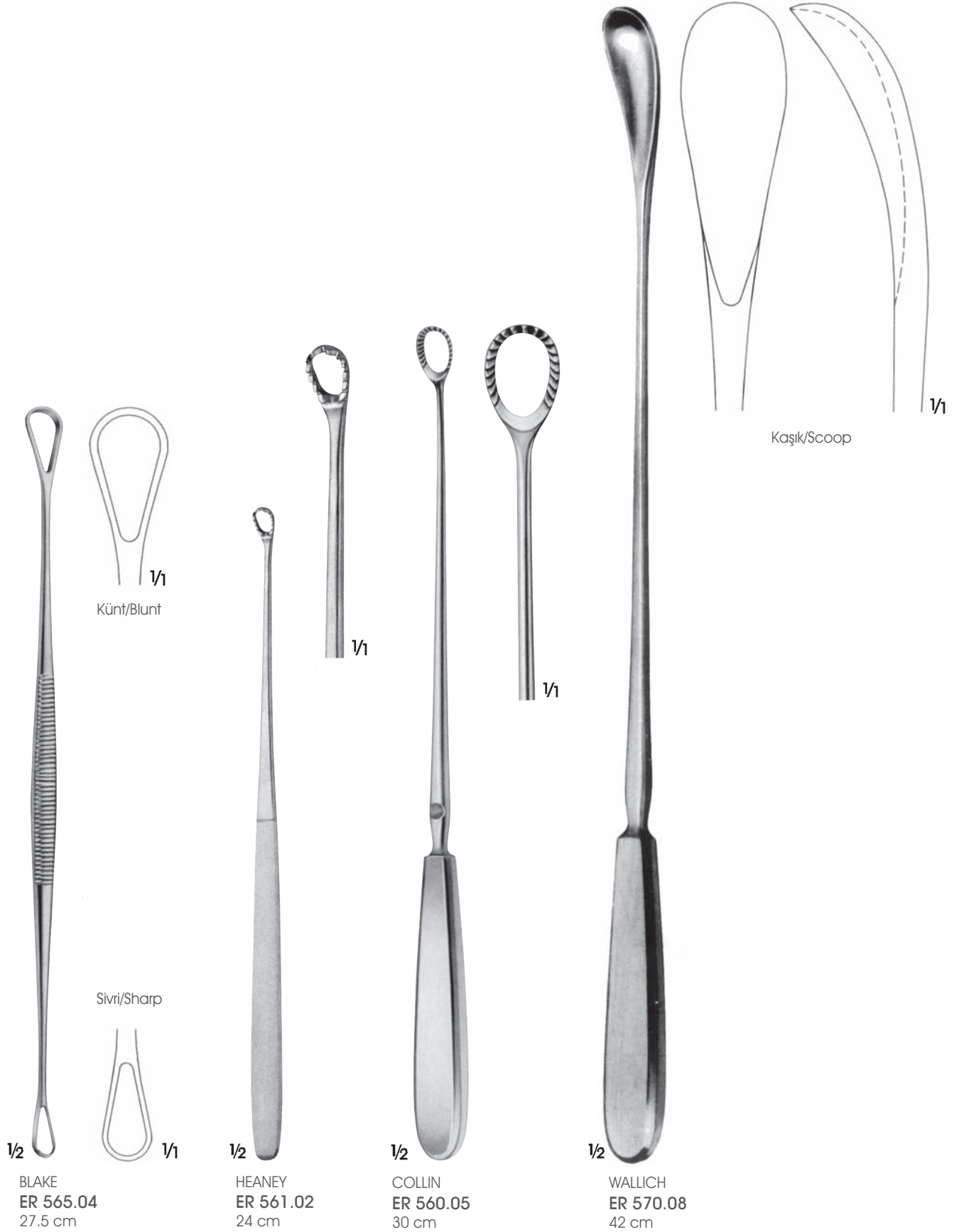

Fig. 1

ER 552.24
ER 554.24
23.5 mm

1/1





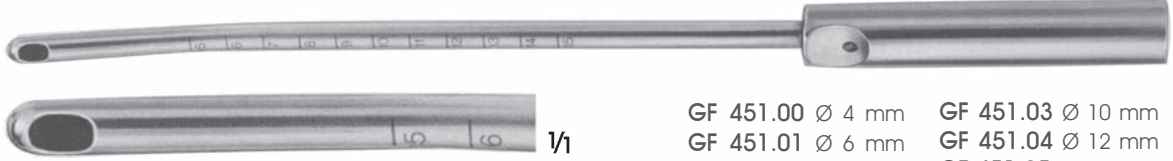

GF 451.00 Ø 4 mm GF 451.03 Ø 10 mm
GF 451.01 Ø 6 mm GF 451.04 Ø 12 mm
GF 451.02 Ø 8 mm GF 451.05 Ø 14 mm

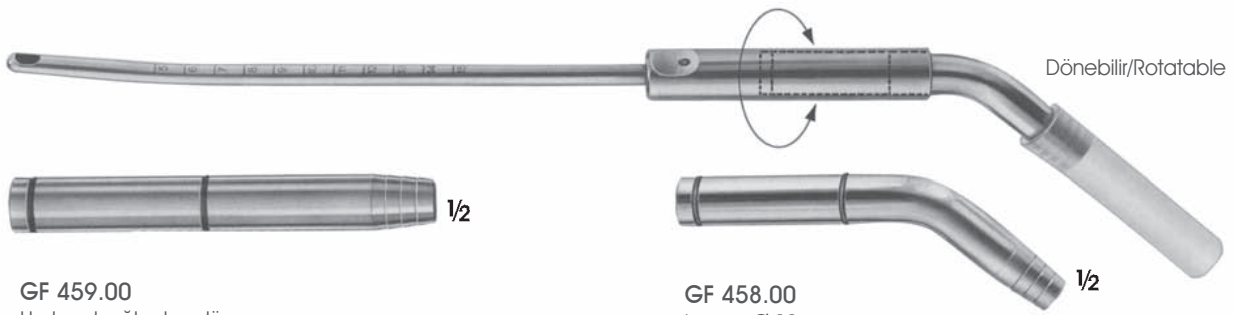

GF 459.00
Hortum bağlantısı, düz
Hose connection, straight
iç çap Ø 11 mm
inside diam Ø 11mm

GF 458.00
iç çap Ø 11 mm
inside diam Ø 11mm

Çalışması :

Arzu edilen (ihtiyaç duyulan) vakum miktarı ayarlama vidası ile sürekli olarak istenilen değere ayarlanabilir. Vakum oluştuğunda bu vakumun emme kafalarına uygulanması için hızlı-kesme düğmesinin sağa veya sola basılması ile sağlanır. Ayarlanan vakum değeri vakum ayar vidası ile değiştirilebilir. Emme işleminin aniden durdurulması isteniyorsa hızlı-kesme düğmesi kapatılır. Böylece emme kafasına gelen vakum kesilmiş ve emme kavanozuna akış durdurulmuş olur.

Function:

The vacuum required can be constantly preset by the adjusting screw. This vacuum exists then up to the closed quick-shutter, thus the vacuum in the suction head is pressed from the left to the right, the nounted suction head is immediately put under the preset vacuum. In case the preset vacuum has to be changed, this can be done with the adjusting screw. For immediate removal of the suction head simply close the quick-shutter, thus the vacuum in the suction head is eliminated at once whereas the vacuum in the suction jar remains unchanged.

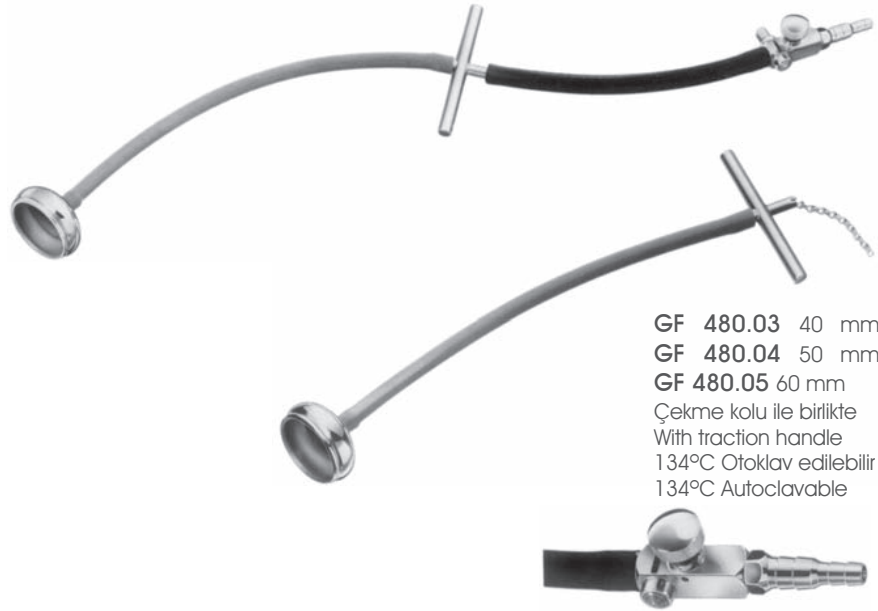

GF 480.03 40 mm
GF 480.04 50 mm
GF 480.05 60 mm
Çekme kolu ile birlikte
With traction handle
134°C Otoklav edilebilir
134°C Autoclavable

GF 480.10
El vanası ve bağlantı borusu
20 cm uzunluğunda bağlantı borusu
Hand valve with connection hose
20 cm long connection hose

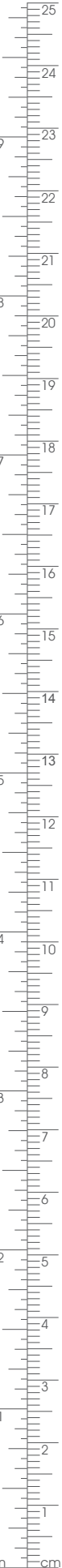

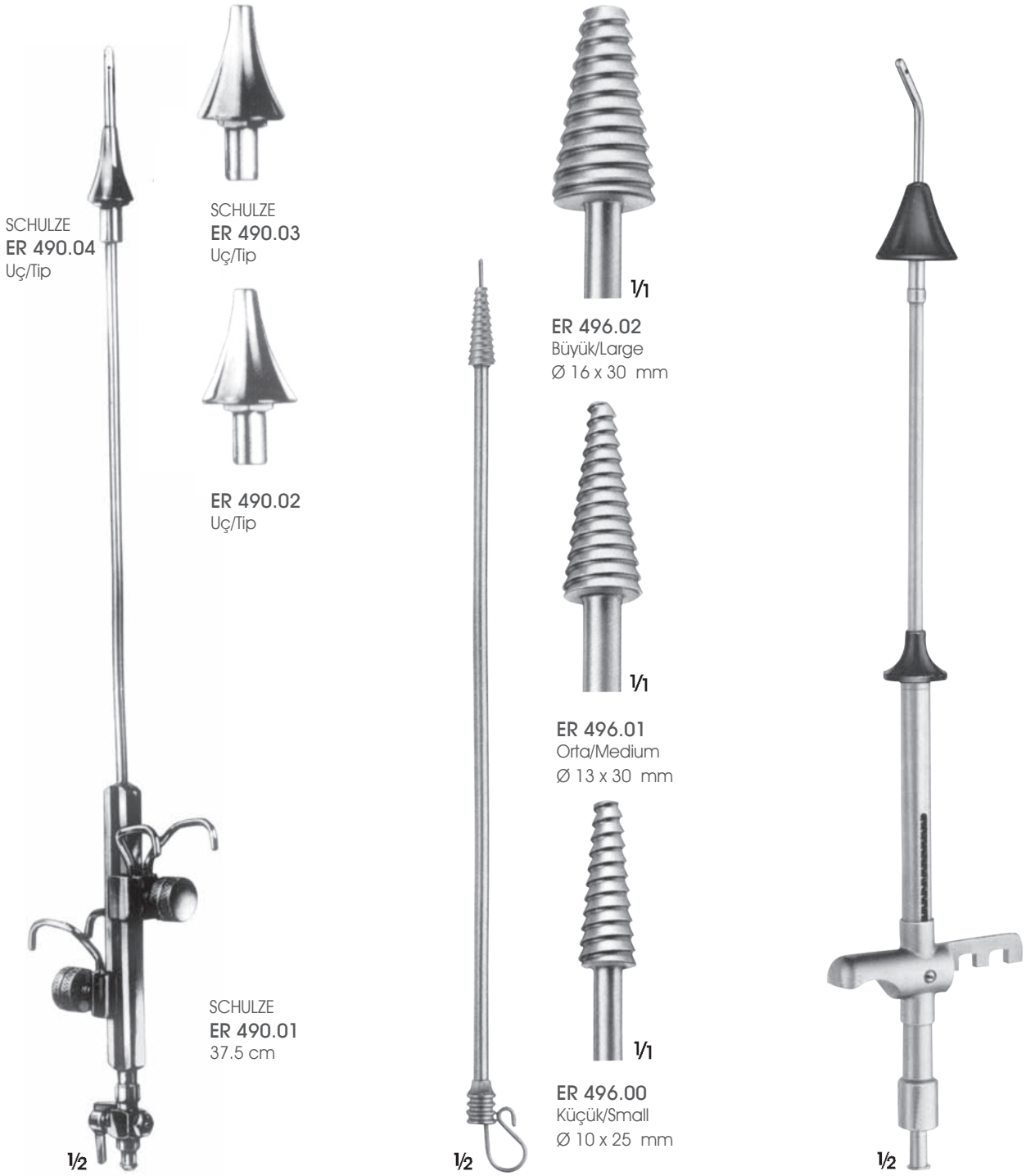

SCHULZE
ER 490.04
Uç/Tip



SCHULZE
ER 490.03
Uç/Tip



ER 490.02
Uç/Tip



ER 496.02
Büyük/Large
Ø 16 x 30 mm



ER 496.01
Orta/Medium
Ø 13 x 30 mm



ER 496.00
Küçük/Small
Ø 10 x 25 mm

SCHULZE
ER 490.01
37.5 cm

1/2

1/2

1/2

SCHULZE
ER 490.00 Komple/Complete
ER 490.01
ER 490.02-ER 490.03-ER 490.04
Salpingografi için uterin kanül
Salpingography uterine cannula

LEECH-WILKINSON
ER 496.00-ER 496.02
Uterin kanül
Uterine cannula 26.5 cm

ER 952.00
Rahim kanülü, büyük ve küçük
2 adet değiştirilebilir konik uçları ile
Uterine cannula with spring
connector, self-retaining complete with
2 interchangeable cones large and small
25 cm



SPACKMAN
ER 493.00
Ayarlanabilir plaka ile
vulsulum pensi
With adjustable plate for
vulsulum forceps
36 cm



BEHRMAN
ER 495.00
Konik ucu çıkartılabilir
uterin kanülü
Uterine cannula with
detachable cone
30.5 cm



ROTUNDA
ER 497.00
İrigasyon kanül
Irrigation cannula
20 cm



Özel Set transvajinal paraservikal ve
pupendus anestezi Enjeksiyonu için
Special set for transvaginal injection for
paracervical anestheisa as well as
anestheisa of the pudendus



EJ 133.00
Kılavuz kılıfı
Guide sheath
17.5 cm

EJ 134.00
Enjeksiyon iğnesi
Injection needle
Luer-lock
1,0 x 18.5 cm



DE LEE
AC 610.01
Pelvimetre santimetre ve inç ölçülü
Pelvimeter centimeters and inches
measured



MARTIN
AC 620.01
Santimetre ölçülü
Graduated in centimeters



BEACHAM
ET 295.02
Amniyotom/Amniotome
24 cm



OF 610.01
Poş Açıcı/Pouch opener
44 cm



HERFF
ET 387.02
Zar delici pens
Membrane puncturing forceps
25.5 cm



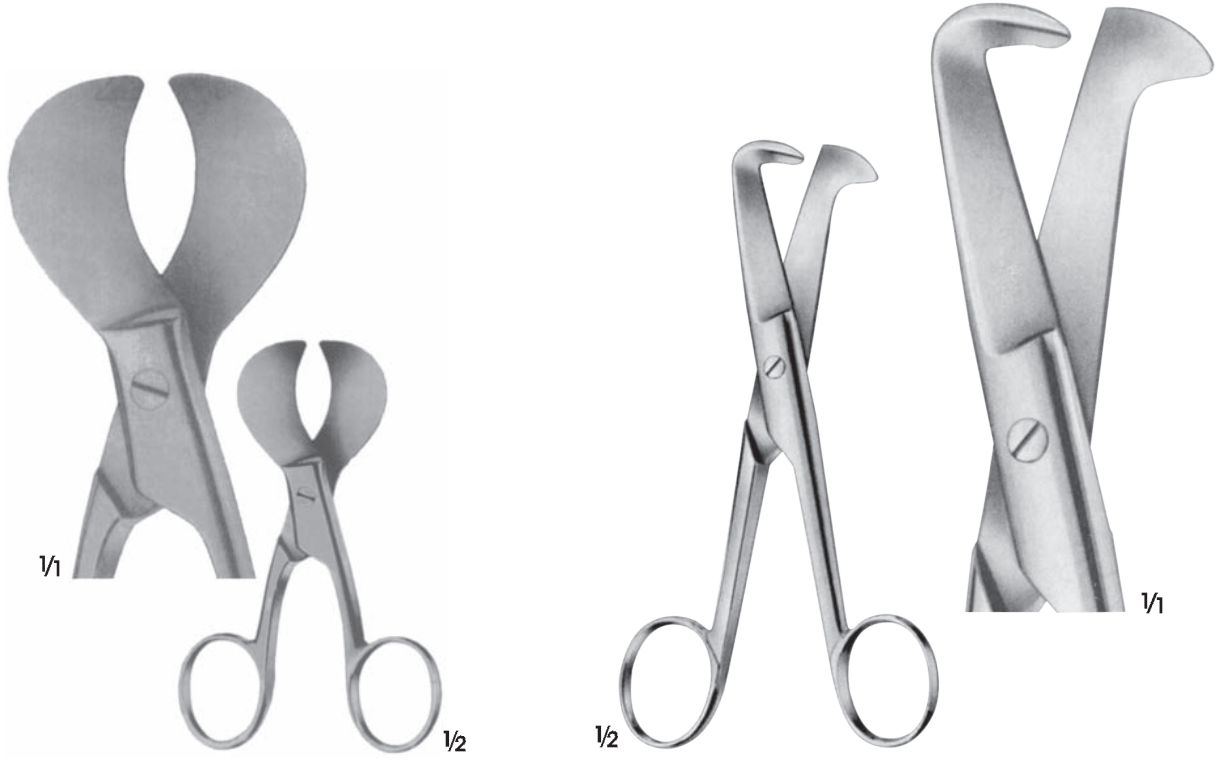

1/1

1/2

1/2

1/1

ET 600.00
Göbek bağı makası
Umbilical cord scissors
10.5 cm

**SCHUMACHER
ET 602.00**
Göbek bağı makası
Umbilical cord scissor
15.5 cm

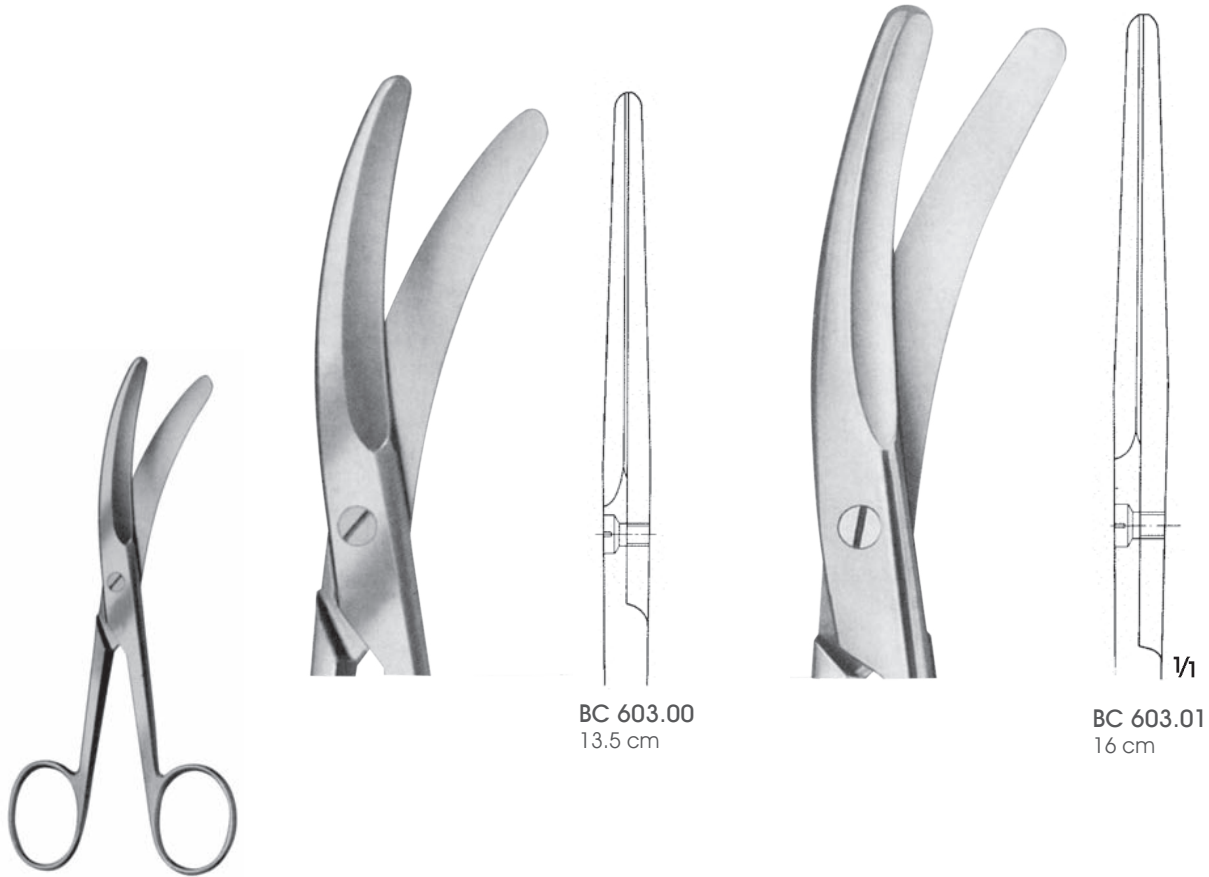

BC 603.00
13.5 cm

BC 603.01
16 cm

BC 603.00-CB 603.01
Göbek bağı makaları
Umbilical cord scissors



BRAUN-STADLER
ET 604.00-ET 604.01
Epizyotomi makasları
Episiotomy scissors



ET 604.00
14.5 cm



ET 604.01
20 cm



ET 610.00
Epizyotomi makas
Episiotomy scissors
24 cm

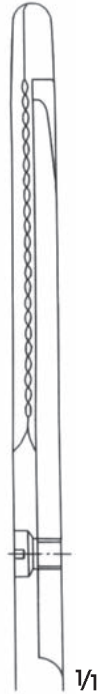

1/1

EB 085.00
Göbek dilatörü
Umbilical dilator
9.5 cm



1/2

COLLIN
ET 425.00
Göbek kordonu klomp
Umbilical cord clamp
8.5 cm





1/3

SIMPSON
ET 558.02
Sezeryan ameliyatı için
For caesarean section
23.5 cm



1/3

SIMPSON-BRAUN
ET 555.00
30.5 cm



1/3

SIMPSON-BRAUN
ET 556.00
35 cm



1/3

NAGELE
ET 557.02
35.5 cm



WRIGLEY
ET 559.02
Sezeryan ameliyatı için
For caesarean section
25 cm



SELHEIM
ET 573.02
Obstetrik levye
Obstetric lever
30 cm



KIELLAND
ET 565.02
42 cm



PIPER
ET 567.02
44.5 cm





TARNIER
ET 578.04
Çekme çubuklu
With traction rod
40 cm



BARNES-NEVILLE
ET 579.04
Çekme sapları
With traction handle
43.5 cm

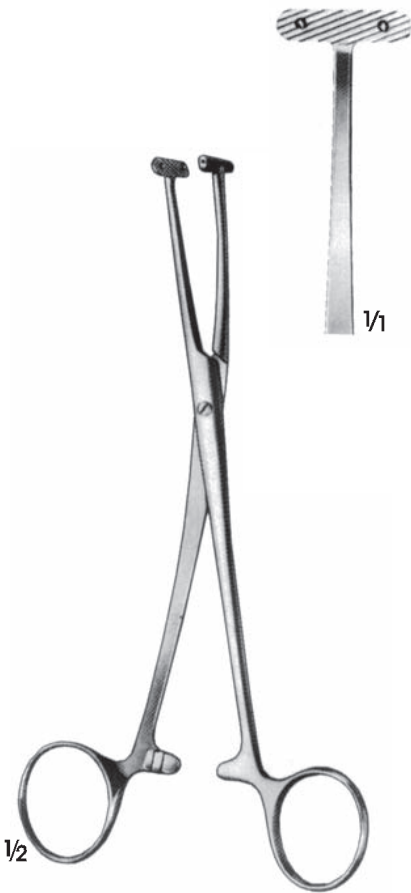

WILLETT
FF 590.01
Kafa derisi tutucu pens
Scalp flap forceps
18.5 cm

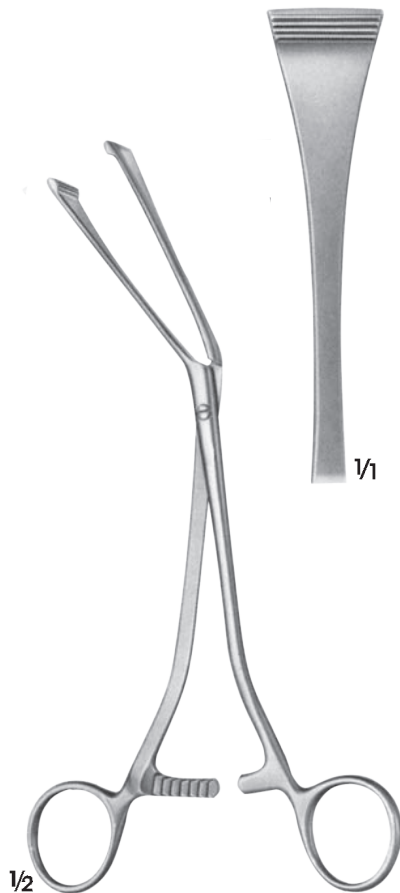

GREEN-ARMYTAGE
ET 593.01
Sezeryan hemostatik pens, açılı
Caesarean hemostatic forceps,
angled
19.5 cm

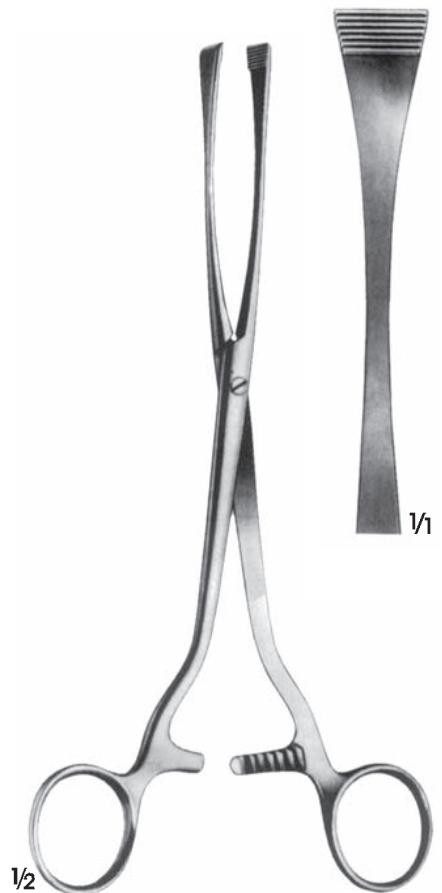

GREEN-ARMYTAGE
ET 594.02
Sezeryan hemostatik pens düz
Caesarean hemostatic forceps,
straight
22 cm



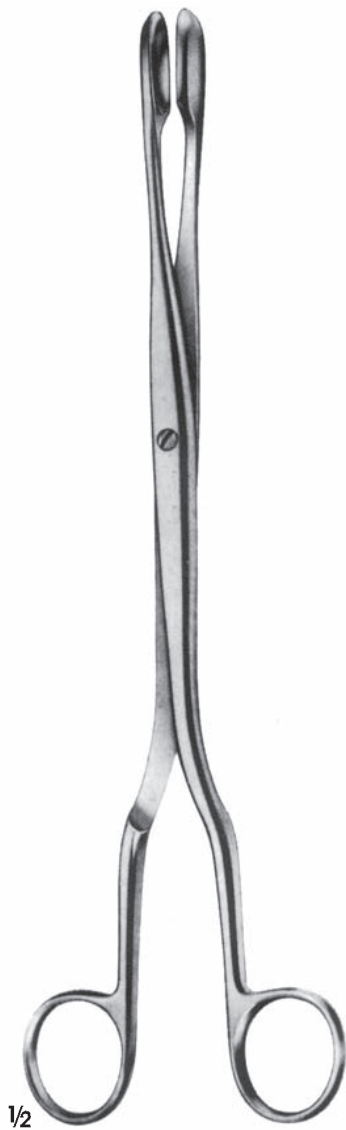
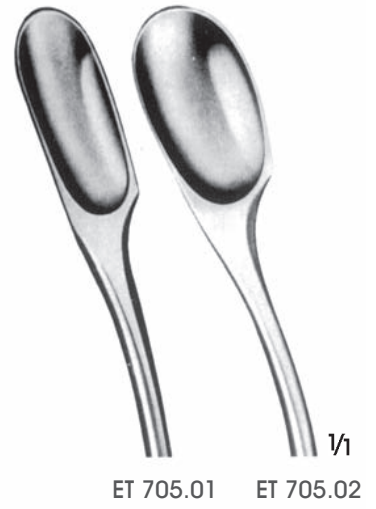

WINTER
ET 700.01-ET 700.02
29 cm



WINTER
ET 702.01-ET 702.03
29 cm



WINTER
ET 705.01-ET 705.02
Kilitli/With ratchet
29 cm



SAENGER
ET 720.02
26.5 cm



SAENGER
ET 721.02
27.5 cm

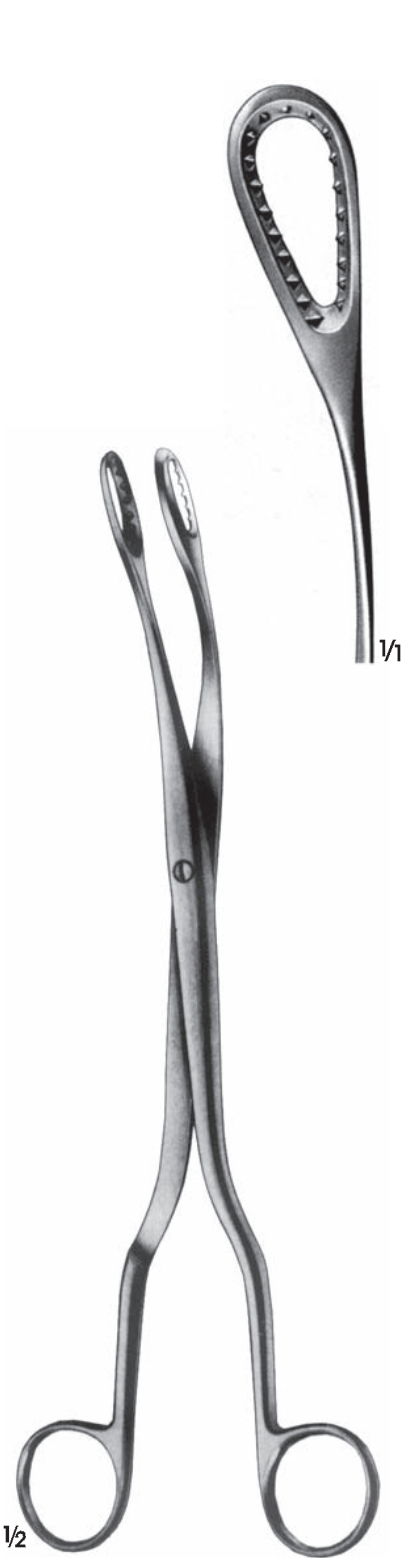

SAENGER
ET 722.02
28.5 cm

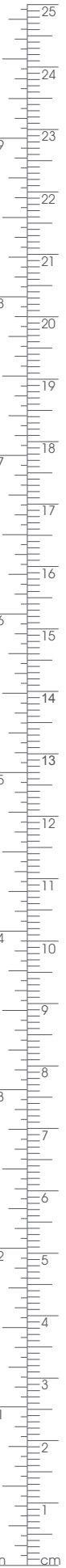



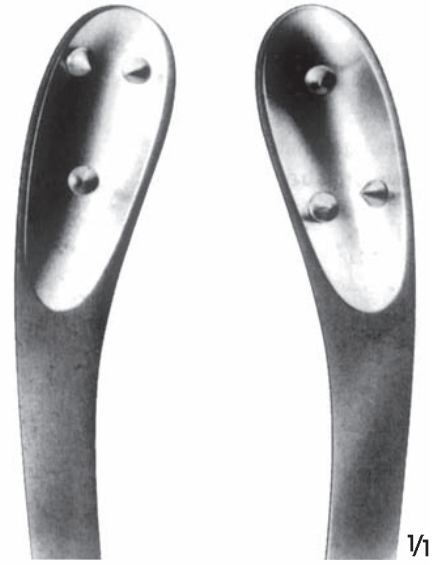

SMELLIE
ET 430.01
27 cm



LEWKOWITZ
EF 730.02-EF 731.02
24.5 cm



BOER
ET 735.02
29 cm

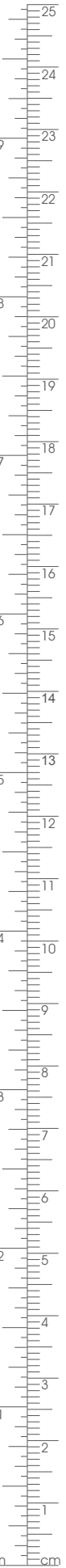

KR Kalp ve Damar Cerrahi
Cardiovascular and Thoracic Surgery



 **ARGENT**

Küçük(sarı)
Small(yellow)



Orta(mavi)
Medium(blue)



Orta-büyük(yeşil)
Medium-large(green)



Büyük(turuncu)
Large(orange)



Küçük(sarı)
Small(Yellow)



FB 070.03 25°
28 cm



FB 071.03 65°
28 cm

Orta(mavi)
Medium(blue)



FB 072.03 25°
28 cm



FB 073.03 65°
28 cm

Orta-büyük(yeşil)
Medium-large(green)



FB 074.03 25°
28 cm



FB 075.05 65°
28 cm



FB 076.03 90°
28 cm

Büyük(turuncu)
Large(orange)



FB 077.03 25°
28 cm



FB 078.03 65°
28 cm



FB 079.03 90°
28 cm

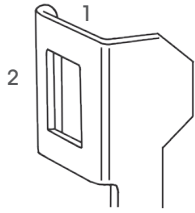

	Göğüs ekartörü bleydleri için ölçü sistemi Derinlik : 1 Genişlik : 2 Örnek: 1 x 2 mm	Measurement system for rib retractor blades Depth : 1 Width : 2 Example: 1 x 2 mm
---	--	---



STRUCK
FB 800.00 Komple/Complete
FB 800.02 Sadece Ekartör/Retractor Only
FB 800.05-FB 800.09 Bleydler(çift)/Blades(pairs)

Bleyd(çift)/Blade(pair)

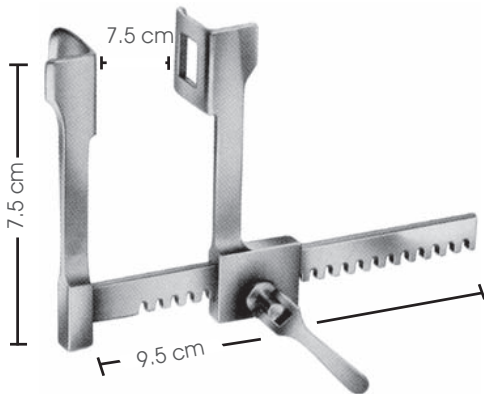

FINOCHIETTO
FB 802.00
Bleydler/Blades
18 x 21 mm

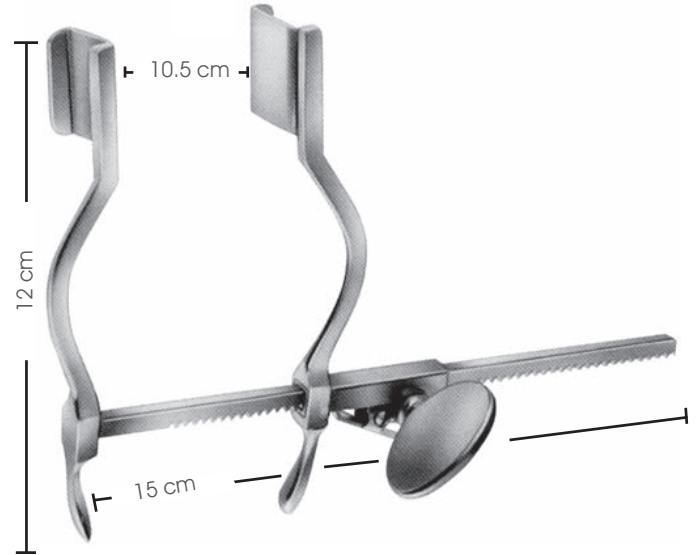

HERTZLER
BV 522.00
Bleydler/Blades
20 x 25 mm

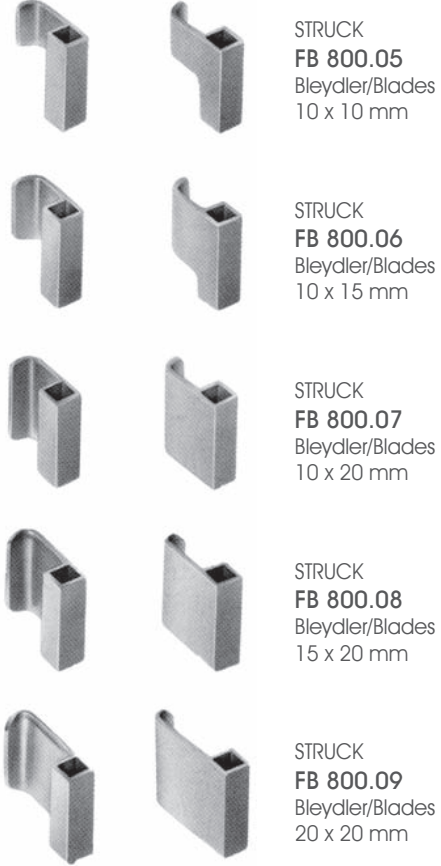

STRUCK
FB 800.05
Bleydler/Blades
10 x 10 mm

STRUCK
FB 800.06
Bleydler/Blades
10 x 15 mm

STRUCK
FB 800.07
Bleydler/Blades
10 x 20 mm

STRUCK
FB 800.08
Bleydler/Blades
15 x 20 mm

STRUCK
FB 800.09
Bleydler/Blades
20 x 20 mm

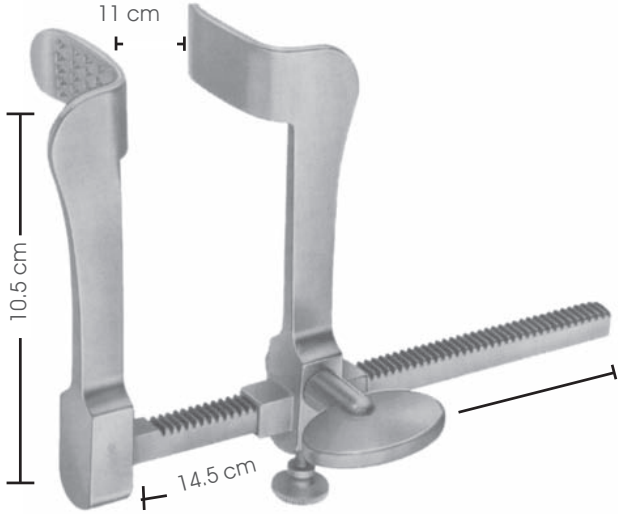

TUFFIER
FB 803.00
Bebekler için göğüs ekartörü
Rib retractor for infants
Bleydler/Blades
32 x 19 mm

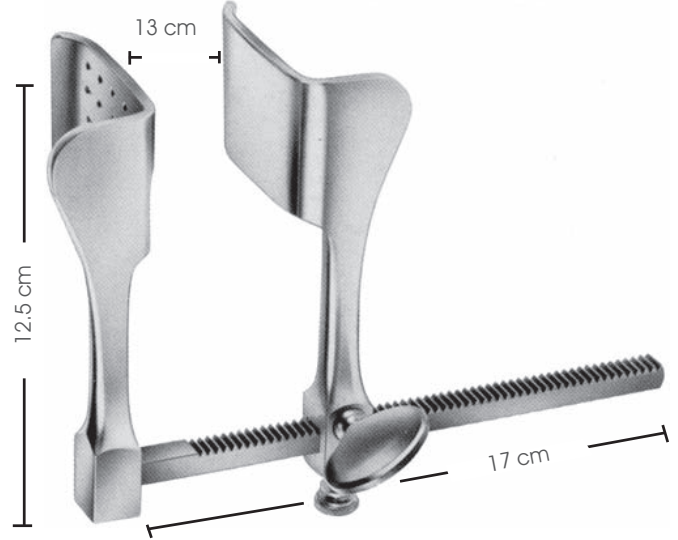

TUFFIER
FB 804.00
Göğüs ekartörü/Rib Retractor
Bleydler/Blades
43 x 53 mm

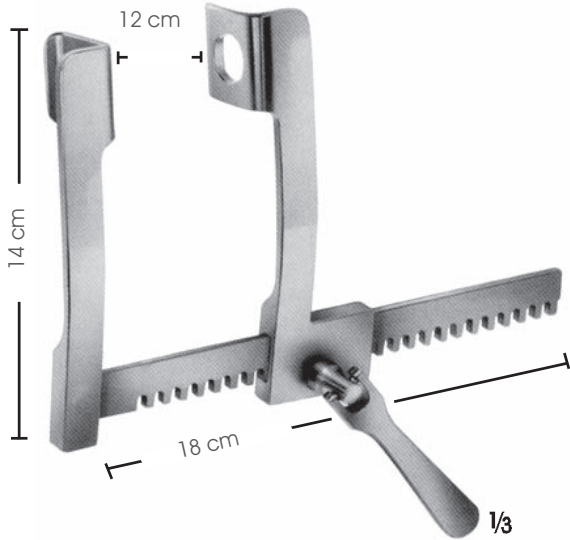

FINOCHIETTO
FB 807.00
Göğüs ekartörü/Rib retractor
Bleydler/Blades
28 x 32 mm

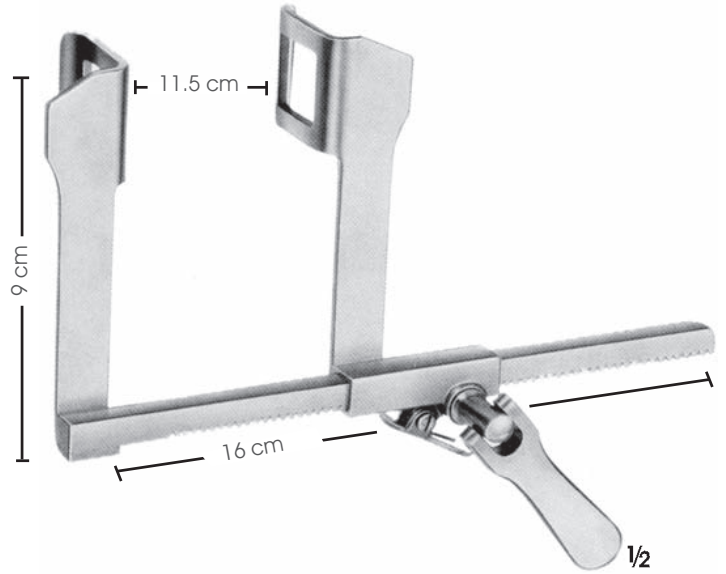

HAIGHT
FB 806.00
Göğüs ekartörü/Rib retractor
Bleydler/Blades
30 x 30 mm

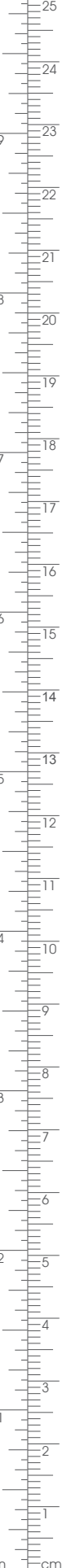

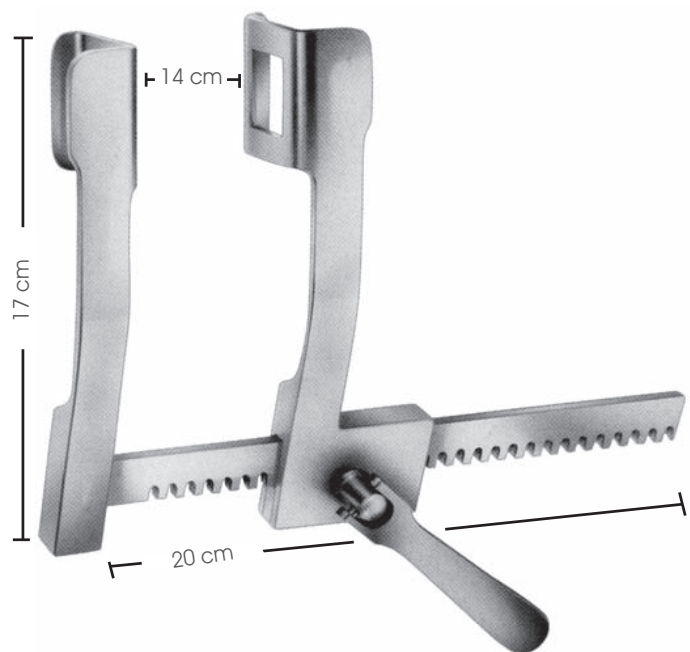

FINOCHIETTO
FB 808.00
Bleydler/Blades
36 x 45 mm

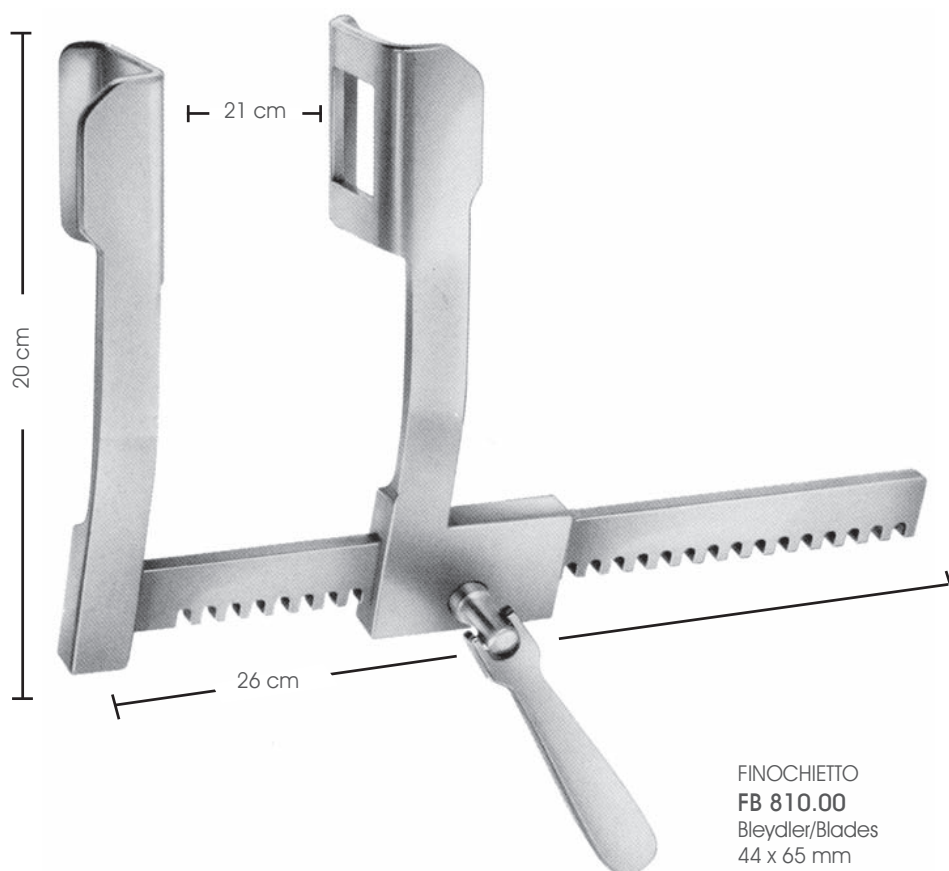

FINOCHIETTO
FB 810.00
Bleydler/Blades
44 x 65 mm

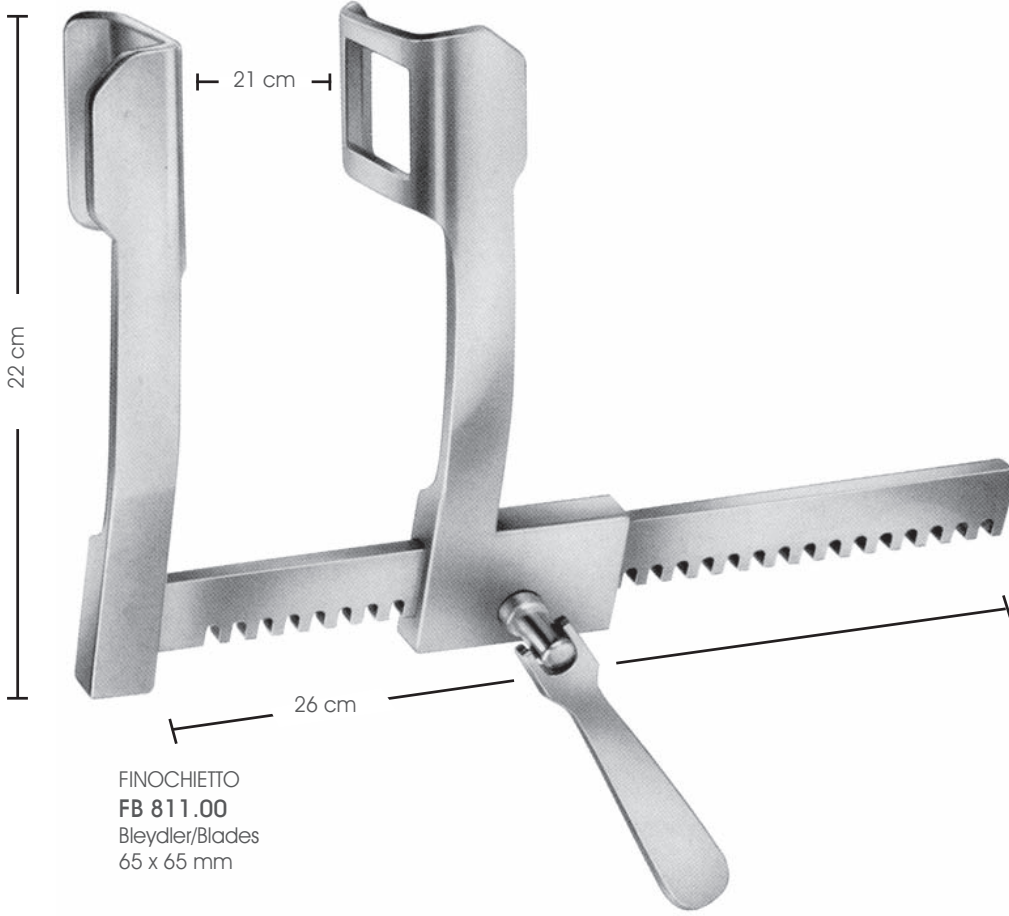

FINOCHIETTO
FB 811.00
Bleydler/Blades
65 x 65 mm

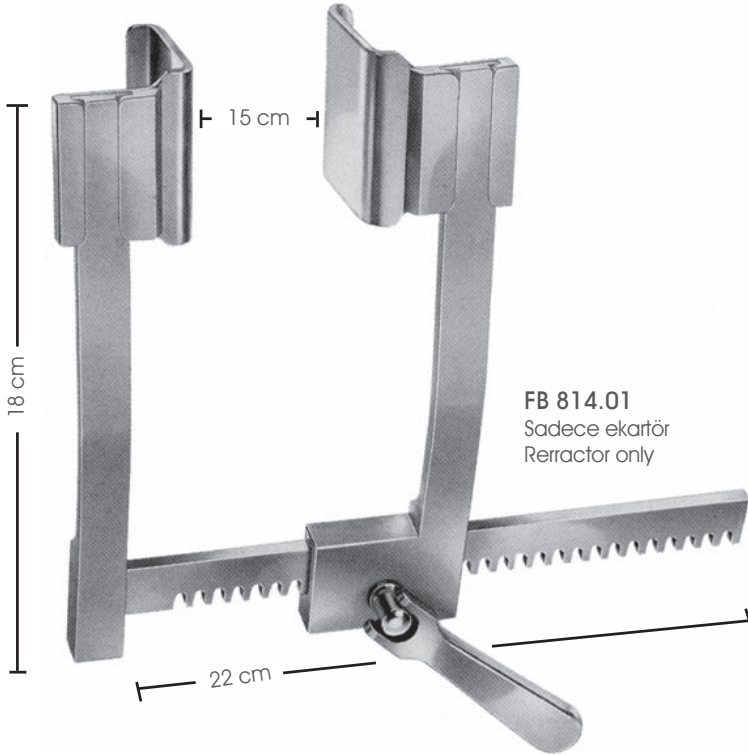

DE BAKEY
FB 814.00 Komple/Complete
FB 814.01 Sadece ekartör/Retractor only
FB 814.05-FB 814.06-814.07 Bleydler(çift)/Blades(pair)

DE BAKEY
FB 814.05
Bleydler/Blades
30 x 30 mm



DE BAKEY
FB 814.06
Bleydler/Blades
40 x 40 mm

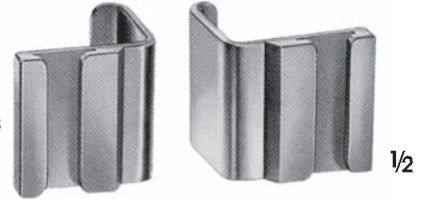

DE BAKEY
FB 814.07
Bleydler/Blades
50 x 50 mm

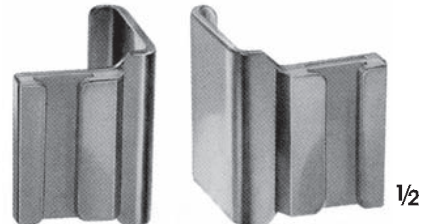

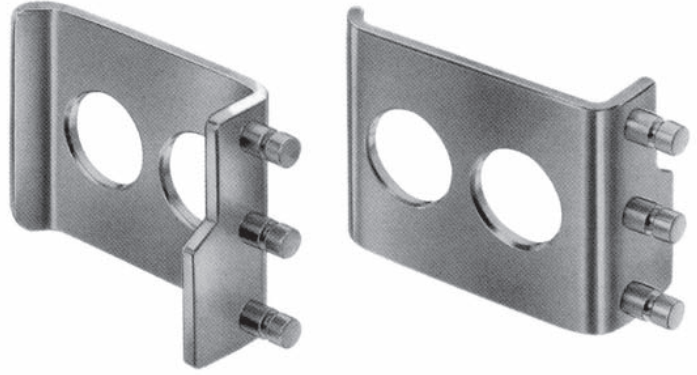

FINOCHIETTO-BURFORD
FB 812.10
Bleydler/Blades
75 x 64 mm

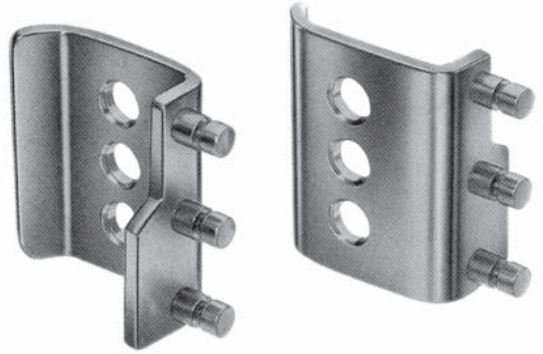

FINOCHIETTO-BURFORD
FB 812.05
Bleydler/Blades
45 x 64 mm

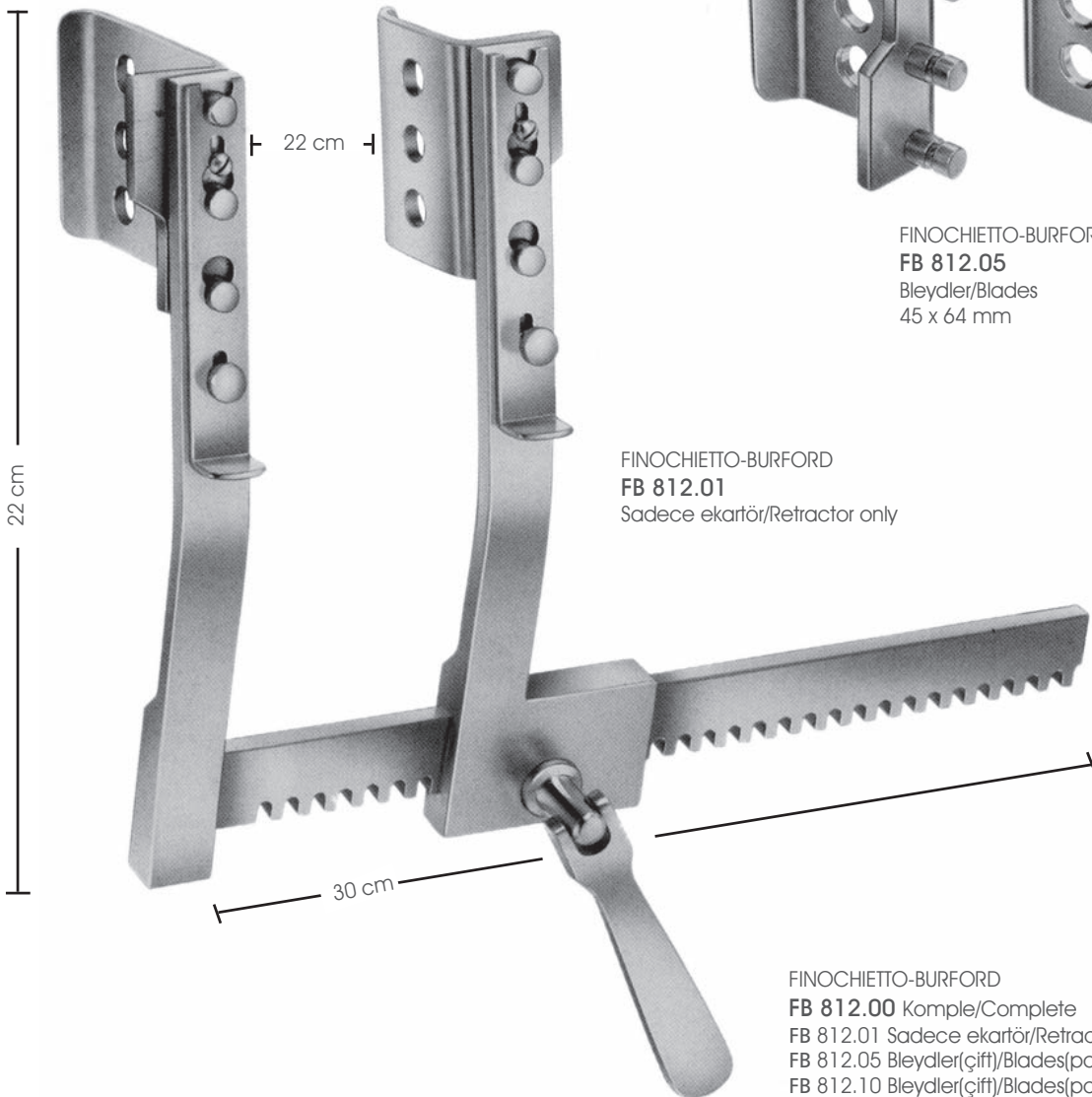

FINOCHIETTO-BURFORD
FB 812.01
Sadece ekartör/Retractor only

FINOCHIETTO-BURFORD
FB 812.00 Komple/Complete
FB 812.01 Sadece ekartör/Retractor only
FB 812.05 Bleydler(çift)/Blades(pairs)
FB 812.10 Bleydler(çift)/Blades(pairs)

Özel Avantajlar:
Değiştirilebilir bleydler için geliştirilmiş sabitleme sistemi
Avantaj Special Advantages :
Improved fixing system for interchangeable blades

DE BAKEY
FB 815.09
Bleydler/Blades
60 x 60 mm

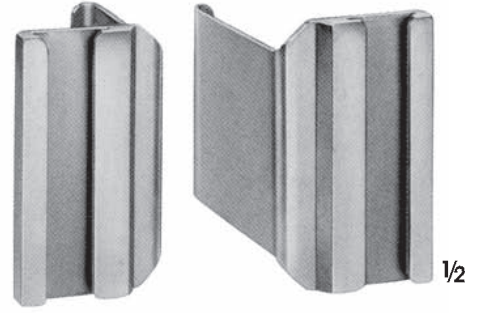

DE BAKEY
FB 815.08
Bleydler/Blades
50x 80 mm

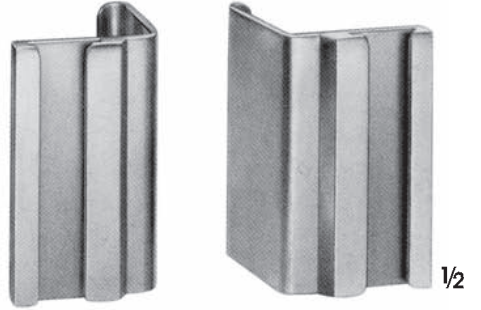

DE BAKEY
FB 815.07
Bleydler/Blades
40 x 100 mm

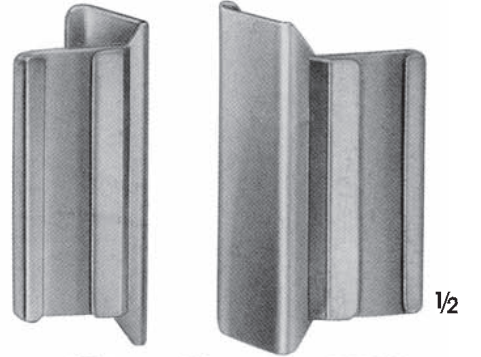

DE BAKEY
FB 815.06
Bleydler/Blades
80 x 60 mm

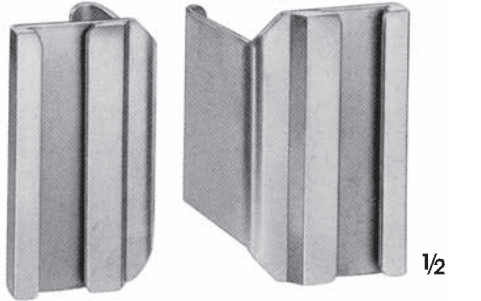

DE BAKEY
FB 815.05
Bleydler/Blades
50 x 66 mm

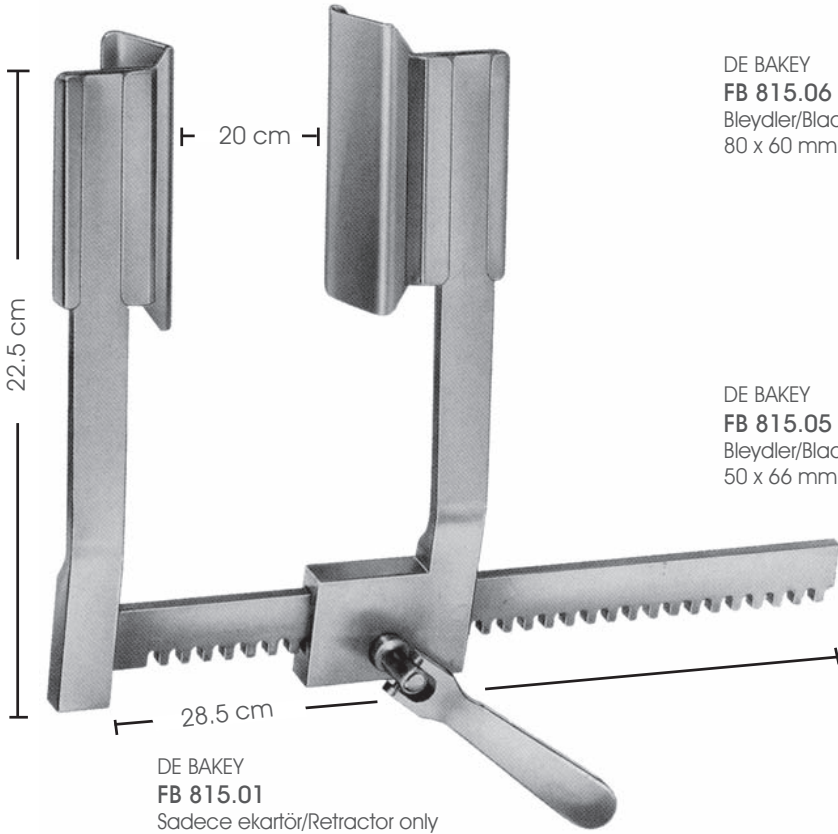
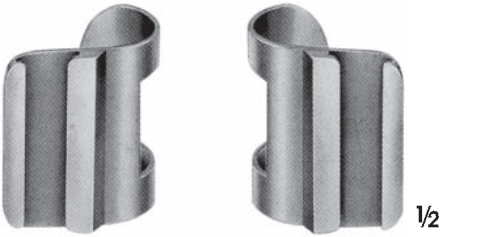

DE BAKEY
FB 815.01
Sadece ekartör/Retractor only

DE BAKEY
FB 815.00 Komple/Complete
FB 815.01 Sadece ekartör/Retractor only
FB 815.07 Bleydler(çift)/Blades(pair)
FB 815.08 Bleydler(çift)/Blades(pair)
FB 815.09 Bleydler(çift)/Blades(pair)

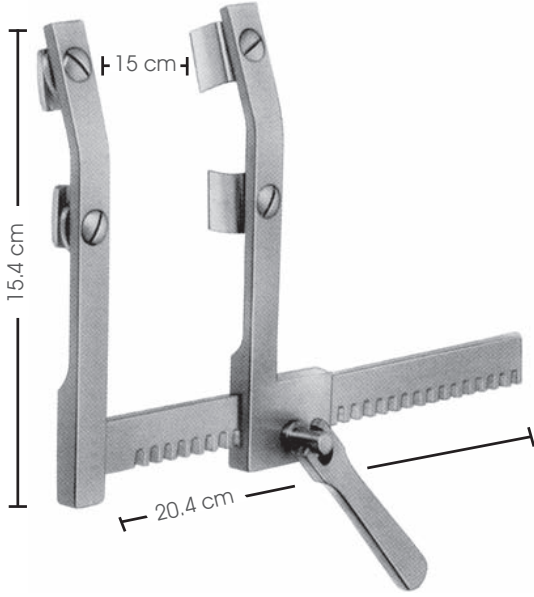

MORSE
FB 820.00
Sternum ayırıcı/Sternum spreaders
Çocuklar için, hareket ettirilebilir çift bleydli
For children with movable double blades
Bleyd/Blade 12 x 20 mm

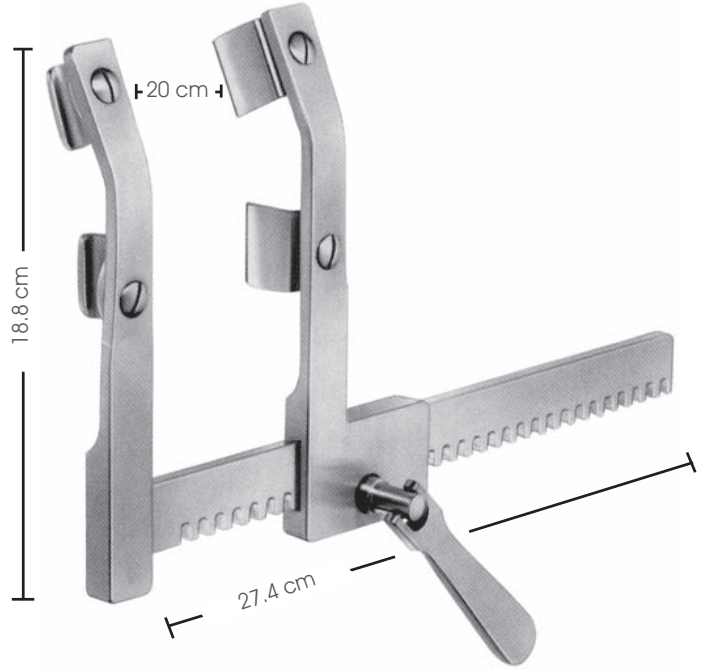

MORSE
FB 820.01
Sternum ayırıcı/Sternum spreaders
Büyükler için, hareket ettirilebilir çift bleydler
For adults with movable double blades
Bleyd/Blade 19 x 29 mm

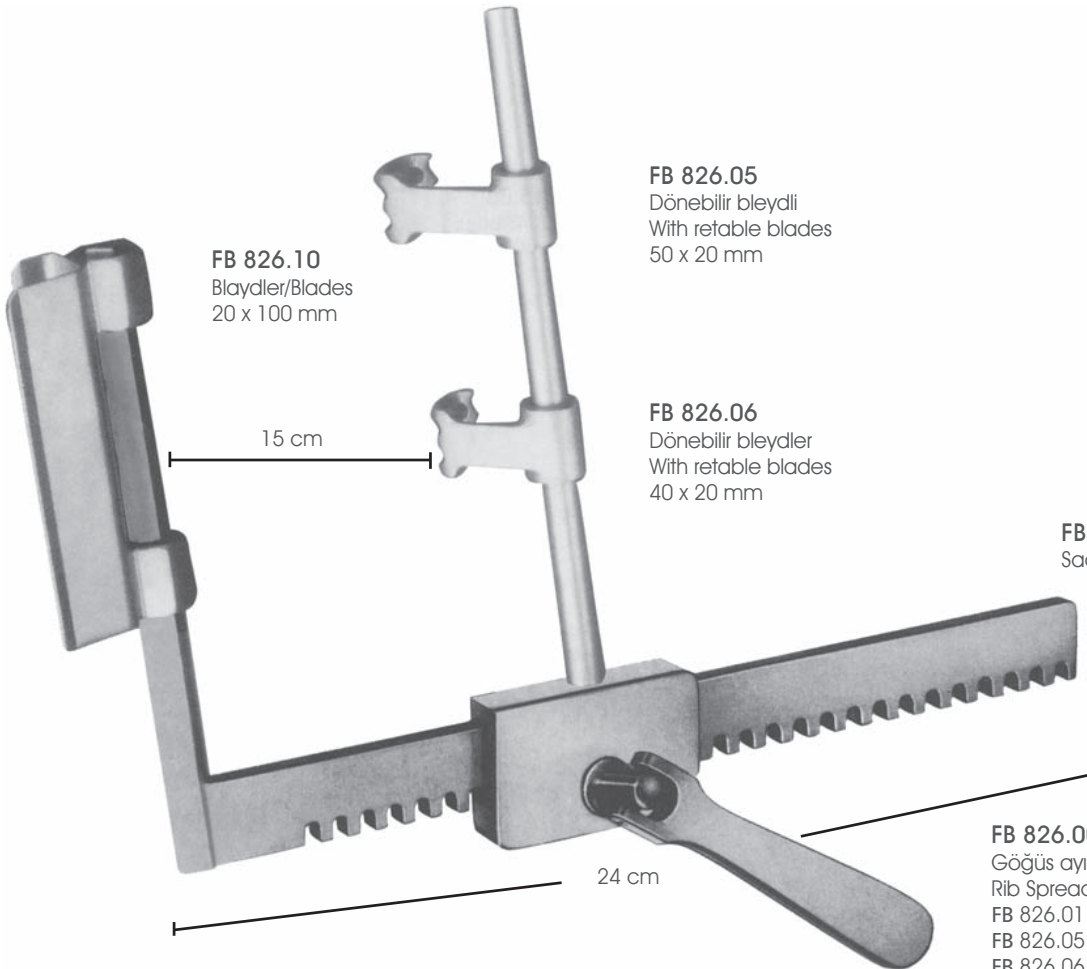

FB 826.10
Blaydler/Blades
20 x 100 mm

FB 826.05
Dönebilir bleydli
With retractable blades
50 x 20 mm

FB 826.06
Dönebilir bleydler
With retractable blades
40 x 20 mm

FB 826.01
Sadece ekartör/Retractor only

FB 826.00
Göğüs ayırıcı komple
Rib Spreader complete
FB 826.01 Sadece ekartör/Retractor only
FB 826.05 Bleyd(çift)/Blade(pair)
FB 826.06 Bleyd(çift)/Blade(pair)
FB 826.10 Bleyd(çift)/Blade(pair)

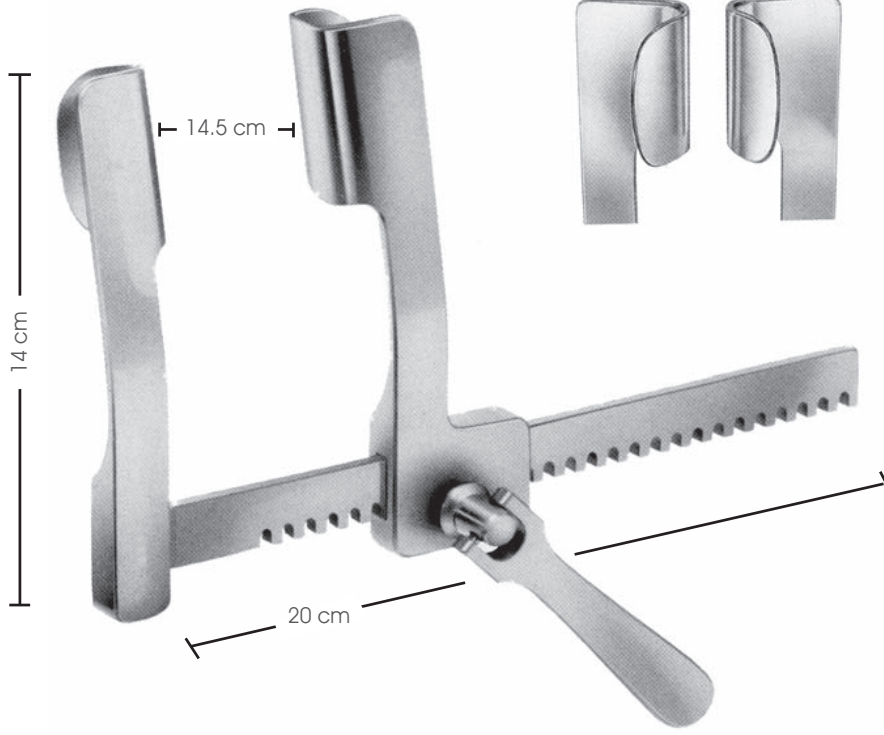

COOLEY
FB 828.02
Bleydler/Blades 21 x 45 mm
Çocuklar için/For children

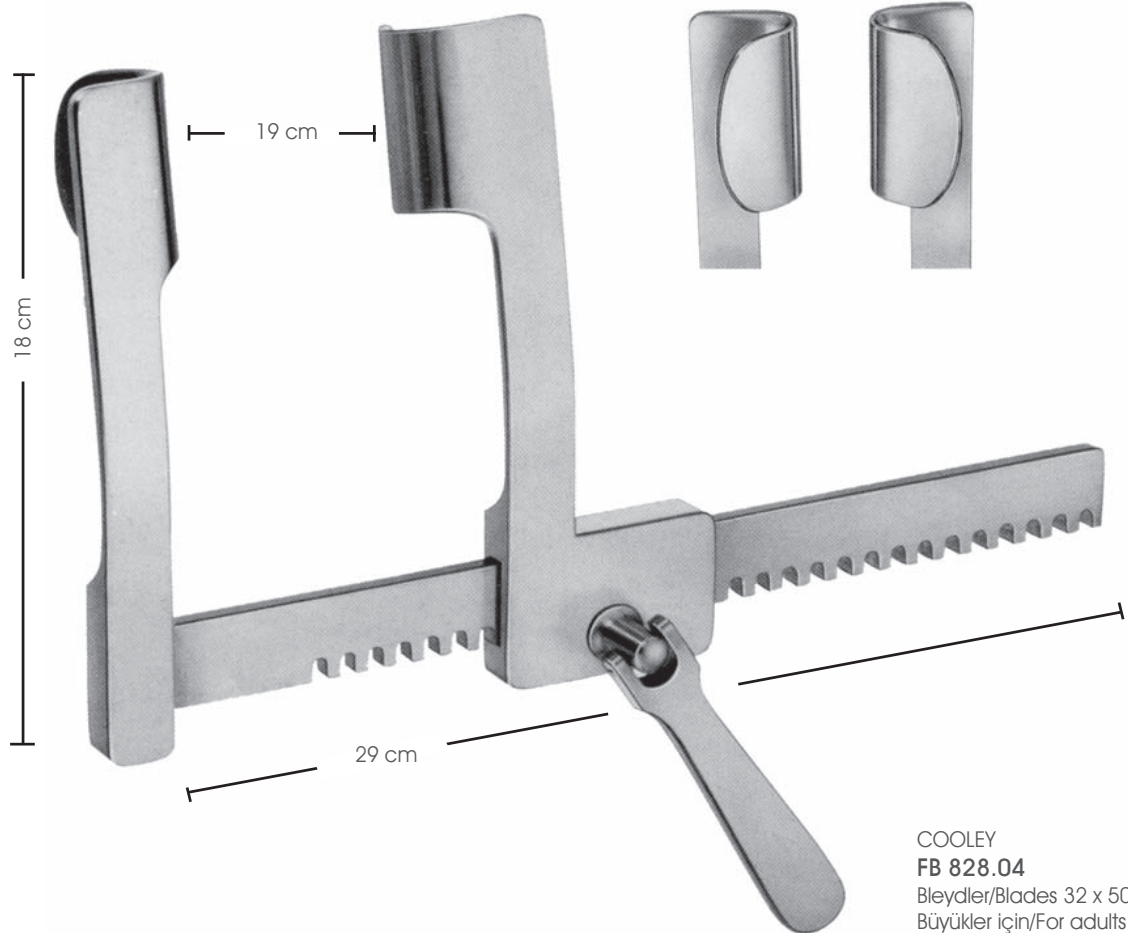

COOLEY
FB 828.04
Bleydler/Blades 32 x 50 mm
Büyükler için/For adults

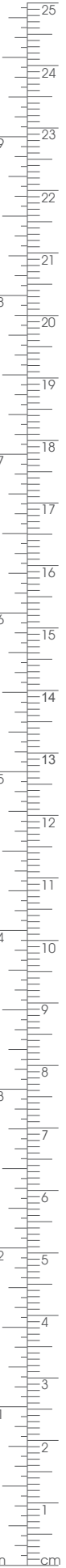

Sternum ekartör veya mamma interna'nın operasyonuna hazırlanması için kullanılır.
Used as Sternum retractor or used for preparation of the arteria mamma interna.

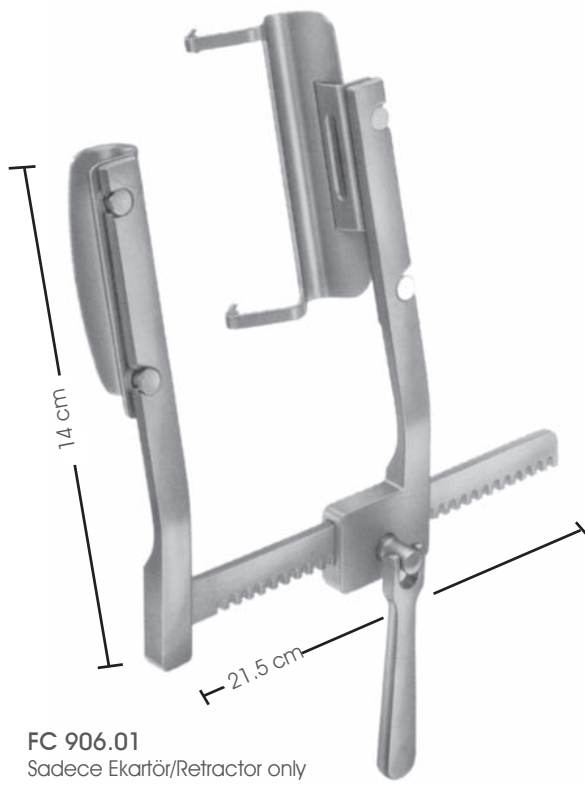

FC 906.01
Sadece Ekartör/Retractor only

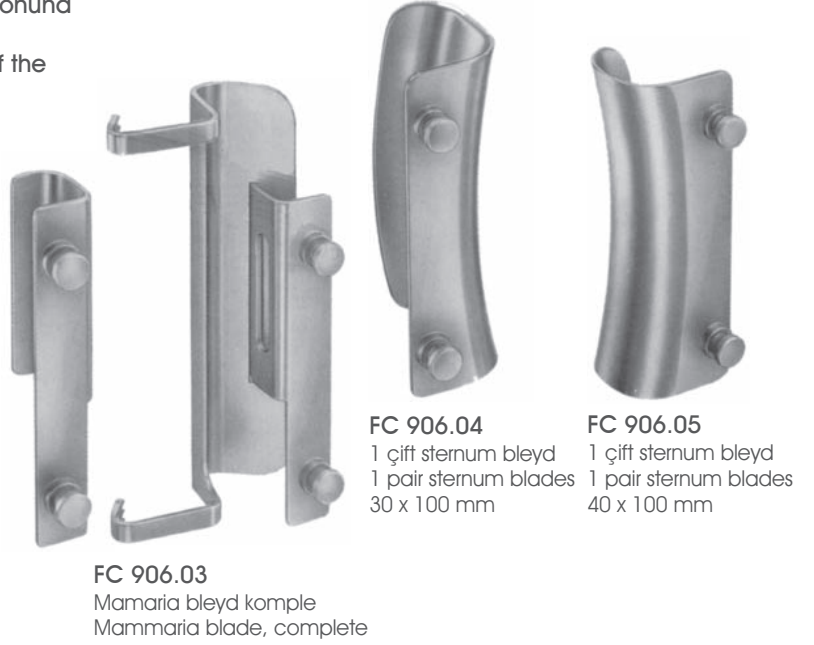

FC 906.03
Mamma bleyd komple
Mammaria blade, complete

FC 906.04
1 çift sternum bleyd
1 pair sternum blades
30 x 100 mm

FC 906.05
1 çift sternum bleyd
1 pair sternum blades
40 x 100 mm

FC 906.00
Mamma ekartörü komple/Mammaria retractor complete
FC 906.01 Sadece ekartör/Retractor only
FC 906.03 Mamma bleyd komple/Mammaria blade complete
FC 906.04 Sternum bleydler(Çift)/Sternum blades(Pair)
FC 906.05 Sternum bleydler(Çift)/Sternum blades(Pair)

IMA Bleyd/IMA Blade

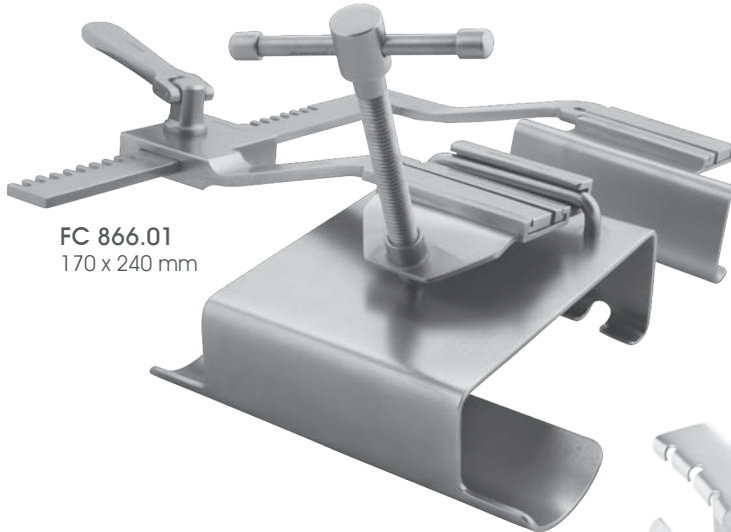

FC 866.01
170 x 240 mm



FC 866.09



FC 866.10

FC 866.20
Torasik Ekartör komple/Thoracic retractor complete
FC 866.01 Sadece ekartör/Retractor only
FC 866.05 Bleyd 1 adet/Blade 1 Piece
FC 866.06 Bleyd 1 adet/Blade 1 Piece
FC 866.08 Bleyd 1 adet/Blade 1 Piece
FC 866.09 Bleyd 1 adet/Blade 1 Piece
FC 866.10 Bleyd 1 adet/Blade 1 Piece



FC 866.05
80 x 100 mm



FC 866.06
100 x 120 mm



FC 866.08
38 x 100 mm

Valf ekartör Sistemi

- Düşük operasyon platformu operasyon alanında cerrahın hareketleri için serbestlik sağlar.
- Aksesuar ve hukların sağlam tesbiti ve mükemmel uygulaması hızlı bağlantı konforu ile birleştirilmiştir.
- Taşıyıcılar kolların ve ayırıcı barların üzerine istenilen pozisyonda takılabilir veya sabitlenebilir.
- Yeni derin valf ekartör dizaynı derin göğüs kafesine sahip hastalarda çalışmak için uygundur.

Valve Retractor System

- The low operating platform provides freedom for surgeon movements in operation area.
- Strong fixation of accessories and hooks and excellent application combined with fast connection comfort.
- Carriers, can be fitted or fixed in any position on the arms and distinctive bars.
- The new deep-valve design of retractor is optimized to work on patients with deep rib cage.

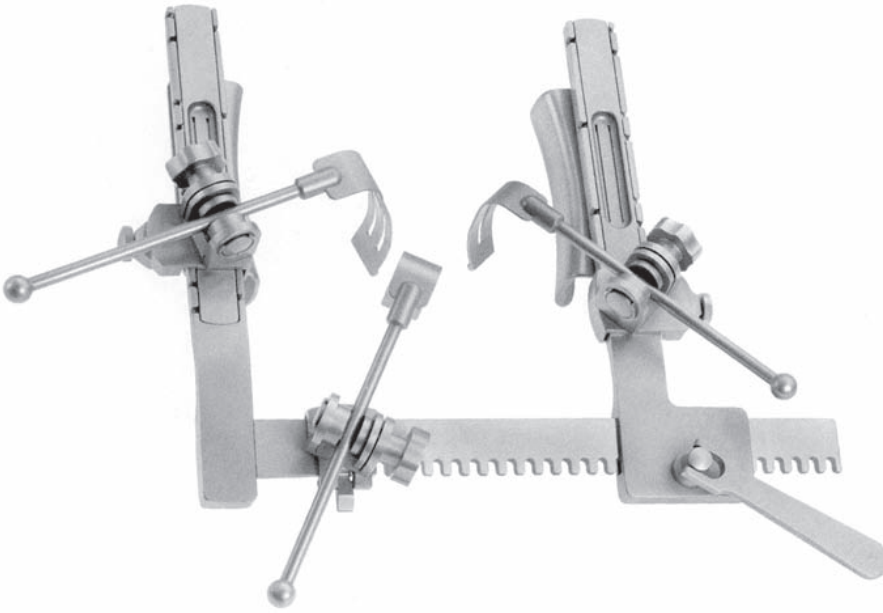

FC 864.05 21 x 20 cm
Sadece Ekartör/Retractor only

- FC 864.00 Komple/Complete
FC 864.05 Sadece ekartör/Retractor only
FC 864.06 Bleyd 2 adet/Blade 2 piece
FC 864.07 Bleyd 2 adet/Blade 2 piece
FC 864.08 Bleyd 4 adet/Blade 4 piece
FC 864.09 Bleyd 4 adet/Blade 4 piece
FC 864.11 Bağlantı klemp 3 adet/Fixation clamp 3 piece
FC 864.13 Ekartör 2 adet/Retractor 2 piece
FC 864.14 Ekartör 2 adet/Retractor 2 piece
FC 864.15 Ekartör 2 adet/Retractor 2 piece



FC 864.11
Bağlantı elmanı
Joint piece



FC 864.08 30 x 28 mm
FC 864.09 40 x 28 mm



FC 864.06 30 x 100 mm
FC 864.07 40 x 100 mm



FC 864.13 Küçük/Small 18 x 52 mm
FC 864.14 Orta/Medium 18 x 80 mm
FC 864.15 Büyük/Large 22 x 80 mm





FB 830.06
Bleydler/Blades 75 x 75 mm



FB 830.05
Bleydler/Blades 42 x 65 mm

FB 830.02
Sadece Ekartör/Retractor only

- FB 830.01** Komple/Complete
FB 830.02 Sadece ekartör/Retractor only
FB 830.05 Bleyd(çift)/Blade(pair)
FB 830.06 Bleyd(çift)/Blade(pair)

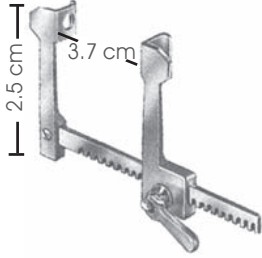

MINI FINOCHIETTO
FC 875.00A
Bleydler/Blades 6 x 7 mm

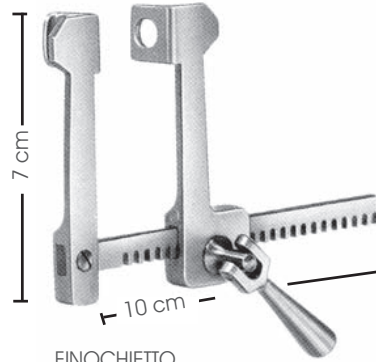

FINOCHIETTO
FC 875.02A
Bleydler/Blades
12 x 15 mm

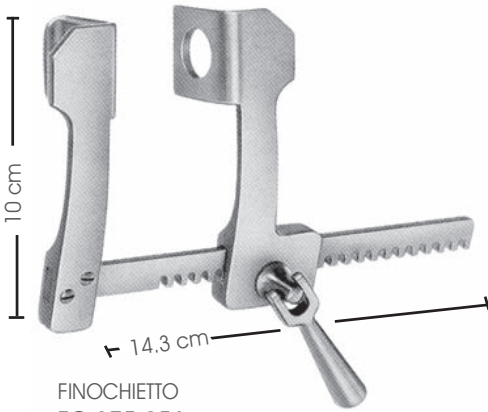

FINOCHIETTO
FC 875.05A
Bleydler/Blades
28 x 30 mm

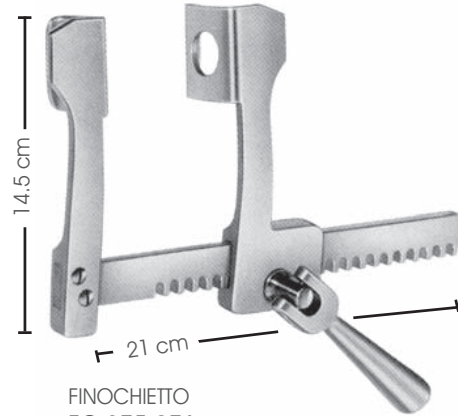

FINOCHIETTO
FC 875.07A
Bleydler/Blades
31 x 45 mm

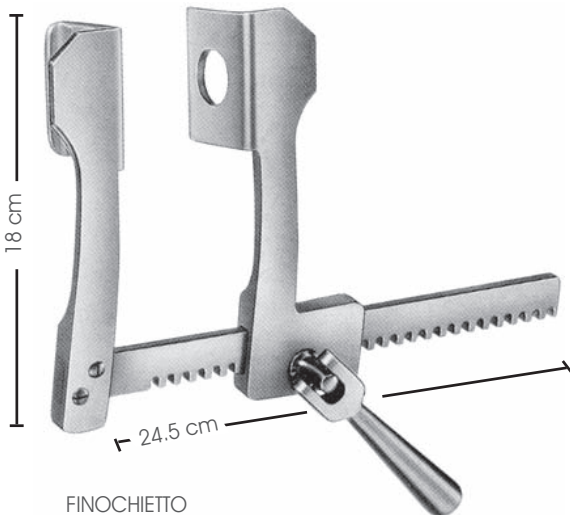

FINOCHIETTO
FC 875.10A
Bleydler/Blades
42 x 61 mm

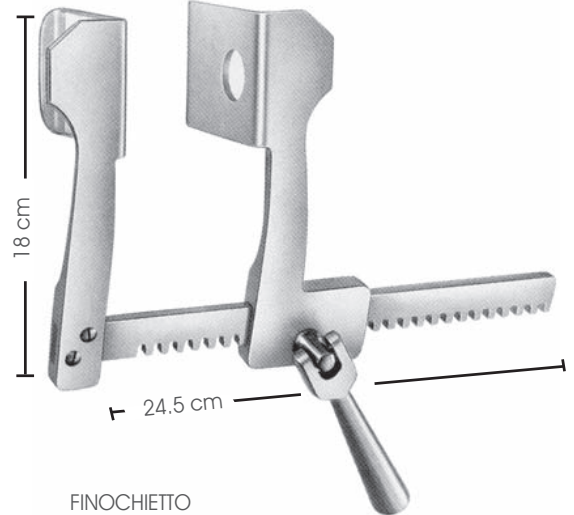

FINOCHIETTO
FC 875.13A
Bleydler/Blades
74 x 64 mm





45 x 30 mm

1/2

COOLEY
FB 695.00P
Ince dişli/Slightly serrated
26.5 cm



45 x 35 mm

1/2

COOLEY
FB 695.01P
Ince Dişli/Slightly serrated
26.5 cm



45 x 48 mm

1/2

COOLEY
FB 695.02P
Sağ ince dişli/Right, slightly serrated
27 cm



45 x 48 mm

1/2

COOLEY
FB 696.02P
Sağ/Right
27 cm



25 x 46 mm

1/2

COOLEY
FB 697.02P
Sol/Left
28 cm

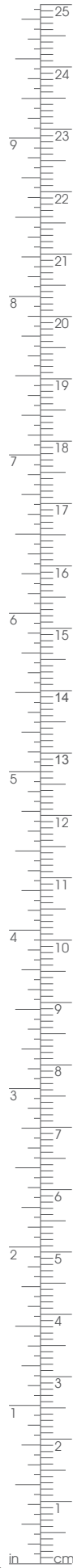



COOLEY
FB 695.00 45 x 30 mm
FB 695.01 45 x 35 mm
FB 695.02 45 x 48 mm
İnce dişli/Slightly serrated
26.5 cm



COOLEY
FB 696.00 45 x 30 mm
FB 696.01 45 x 35 mm
FB 696.02 45 x 48 mm
Dişsiz/Unserrated
24.5 cm



COOLEY
FB 697.02 25 x 46
mm Sol/Left
28 cm



FB 694.00
17 x 21 mm



$\frac{1}{1}$
FB 694.01
16 x 23 mm



FB 694.02
20 x 25 mm



$\frac{1}{1}$
FB 694.03
24 x 27 mm



FB 694.04
28 x 20 mm



$\frac{1}{1}$
FB 694.05
28 x 29 mm



$\frac{1}{2}$
BOROWSKI
FB 694.00-FB 694.05
Bükülebilir şaft/Malleable shaft
27 cm



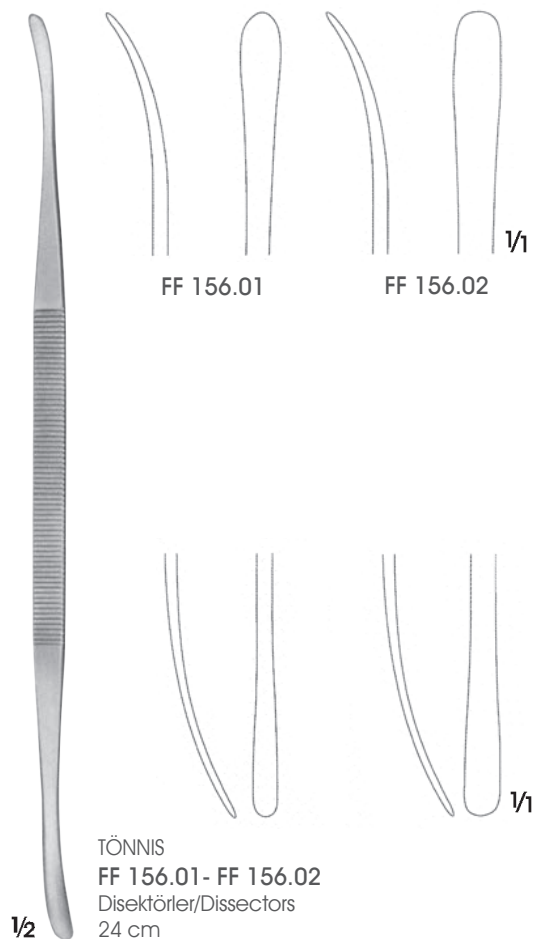
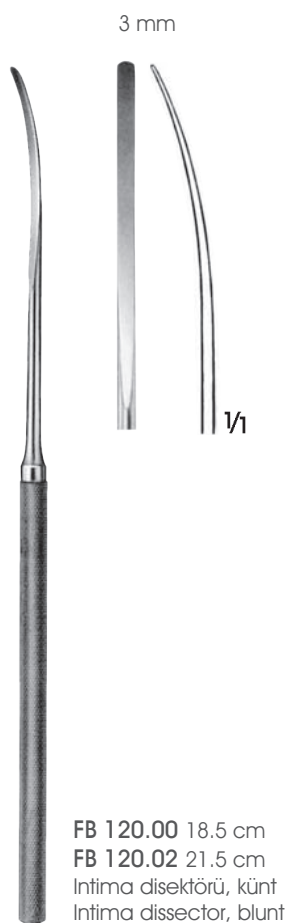
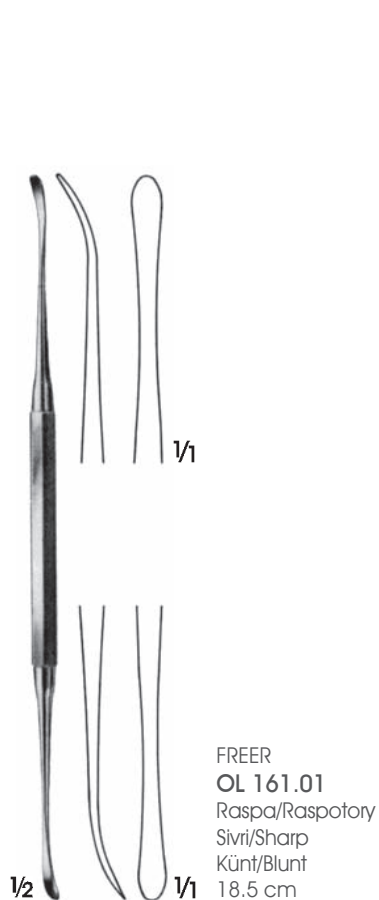
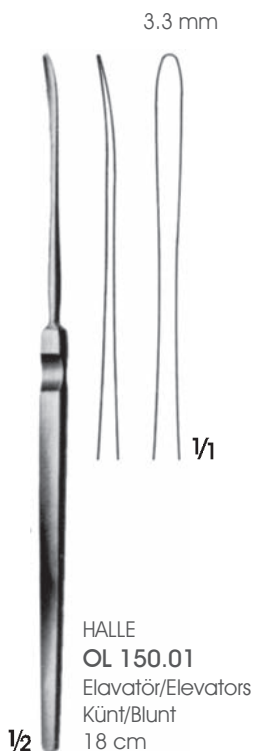
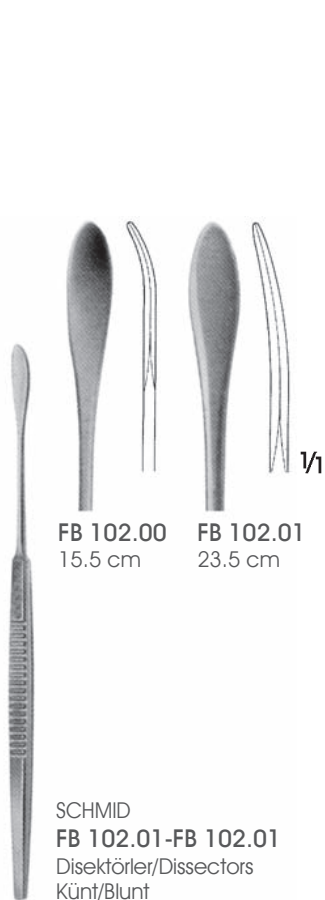

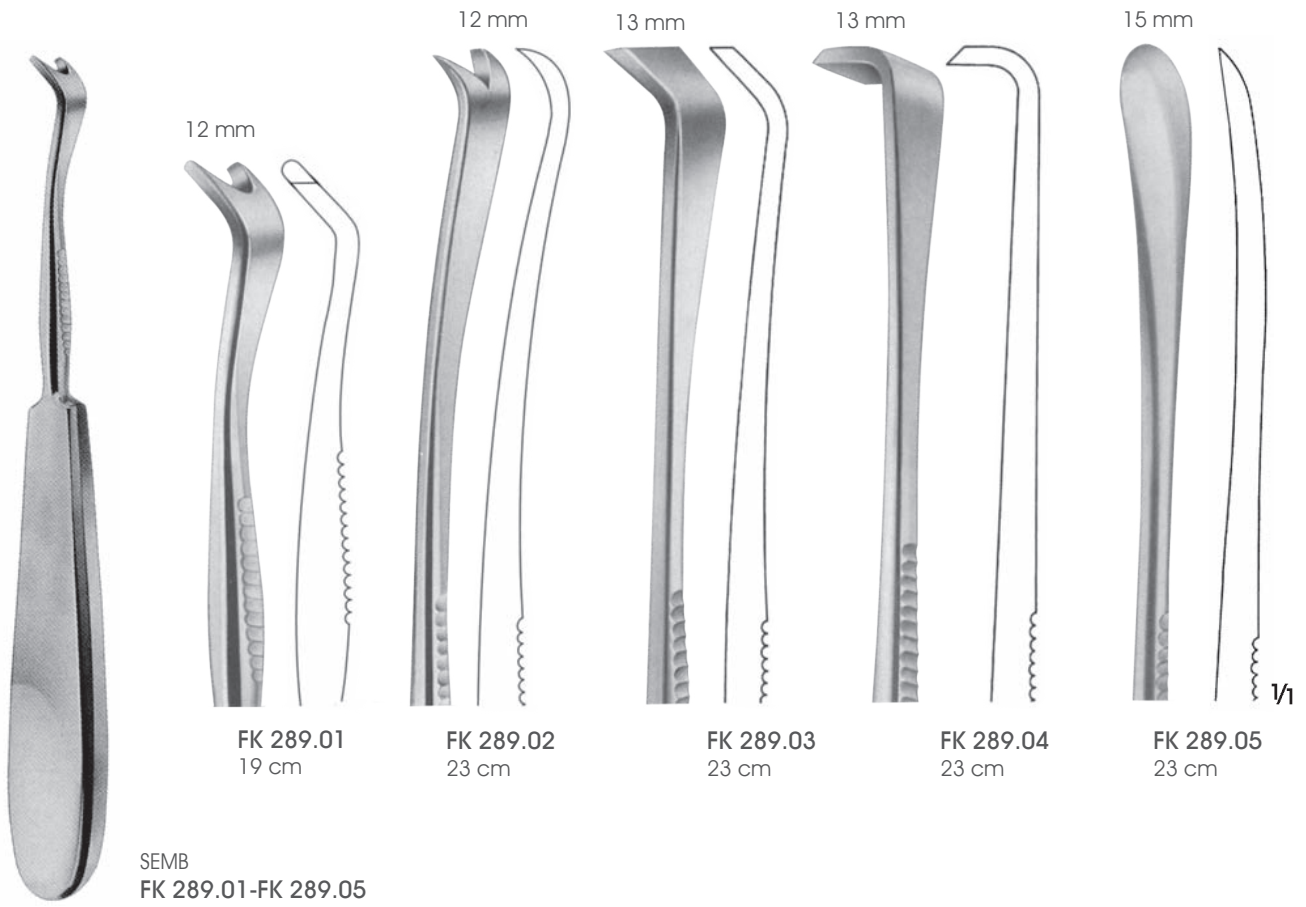

SEMB
FK 289.01-FK 289.05

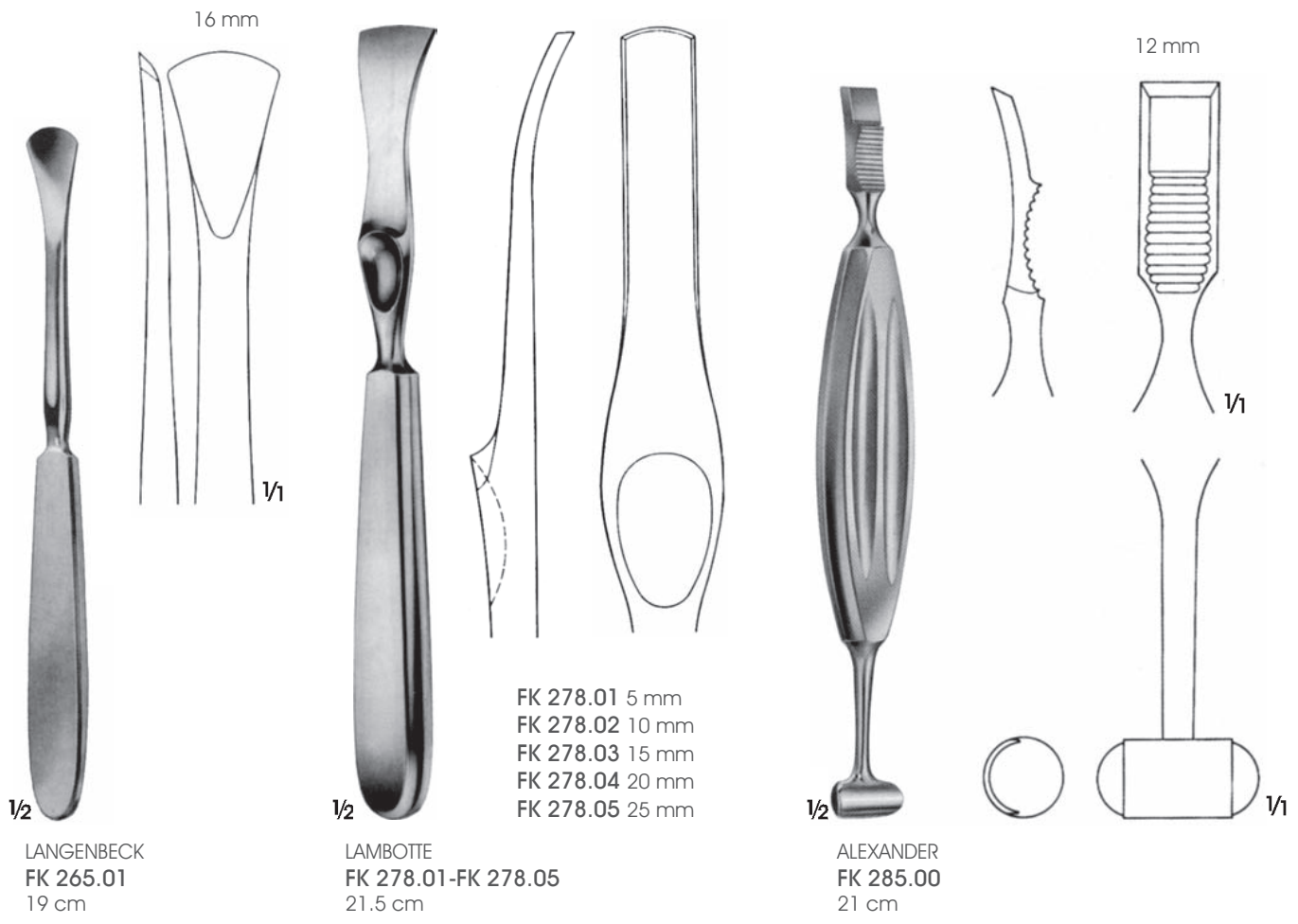

$\frac{1}{2}$
LANGENBECK
FK 265.01
19 cm

$\frac{1}{2}$
LAMBOTTE
FK 278.01-FK 278.05
21.5 cm

$\frac{1}{2}$
ALEXANDER
FK 285.00
21 cm



DOYEN
FK 290.01-FK 291.01
Çocuklar için/For children
17.5 cm

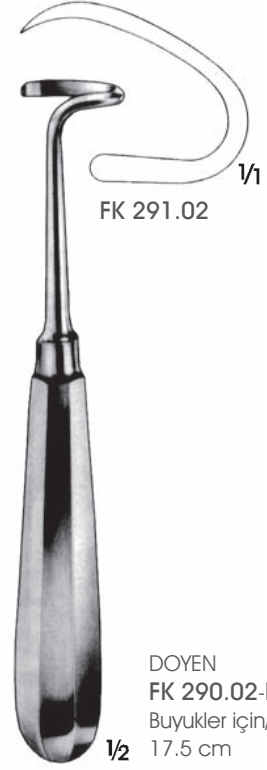

DOYEN
FK 290.02-FK 291.02
Büyükler için/For adults
17.5 cm



DOYEN
FK 292.01-FK 293.01
24 cm



FB 500.03
Esnek plastik sonda ucu
Flexible plastic probe tip



FB 500.04
Ø 3 mm
Metal sonda ucu
Metal Probe tip



FB 500.05
Ø 6 mm



FB 500.06
Ø 9 mm



FB 500.07
Ø 12 mm



FB 500.08
Ø 15 mm



**NABATOFF
FB 500.10**
Sadece sap
Handle only

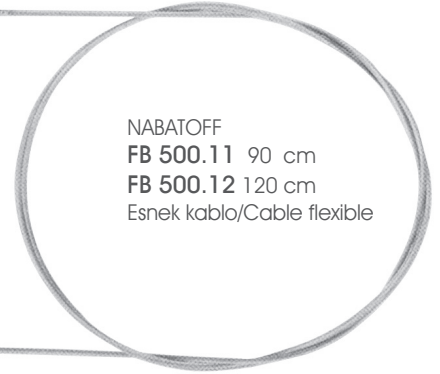

**NABATOFF
FB 500.11** 90 cm
FB 500.12 120 cm
Esnek kablo/Cable flexible

NABATOFF

- FB 500.00** Damar temizleme seti/Vein stripper set, consisting of
FB 500.01 Metal kutu/Metal case
FB 500.11 Esnek kablo 90 cm/Flexible cable 90 cm
FB 500.03 Esnek plastik sonda ucu/Flexible plastic probe tip
FB 500.04 Metal sonda ucu/Metal Probe tip
FB 500.05 Metal uç/Metal end Ø 6 mm
FB 500.06 Metal uç/Metal end Ø 9 mm
FB 500.07 Metal uç/Metal end Ø 12 mm
FB 500.08 Metal uç/Metal end Ø 15 mm
FB 500.10 Esnek kablo sapı/Handle for flexible cable



VARADY

FB 502.00 Mini damar temizleme seti
Mini vein stripper set

- FB 500.01 Metal kutu/Metal case
FB 502.01 Esnek kablo 45 cm/Flexible cable 45 cm
FB 502.03 Metal uc/Metal end Ø 3 mm
FB 502.04 Metal uc/Metal end Ø 4 mm
FB 502.05 Metal uc/Metal end Ø 5 mm



VARADY

FB 502.01
Esnek kablo
Flexible cable
45 cm



FB 502.03
Ø 3 mm



FB 502.04
Ø 4 mm



FB 502.05
Ø 5 mm



**VARADY
FB 580.05**
Mikro çıkartıcı
Micro Extractor
17 cm



**VARADY
FB 580.06**
Mini çıkartıcı
Mini Extractor
17 cm

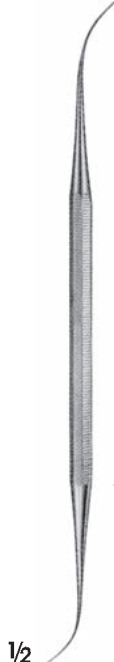

**VARADY
FB 580.07**
Mikro spatula,
çift taraflı
Micro spatula,
double ended
17.5 cm

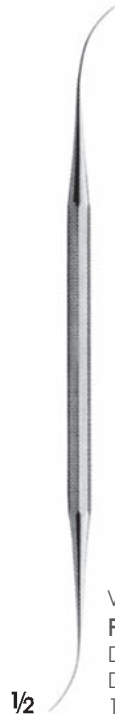

**VARADY
FB 580.00**
Disektor
Dissector
18 cm



**VARADY
FB 580.01**
Çıkartıcı
Extractor
18 cm



**VARADY
FB 580.02**
Çıkartıcı
Extractor
18 cm





DE BAKEY
FB 510.02-FB 510.17 19 cm
FB 511.02-FB 511.17 38 cm
Damar dilatörleri, bükülebilir
Vascular dilators, malleable

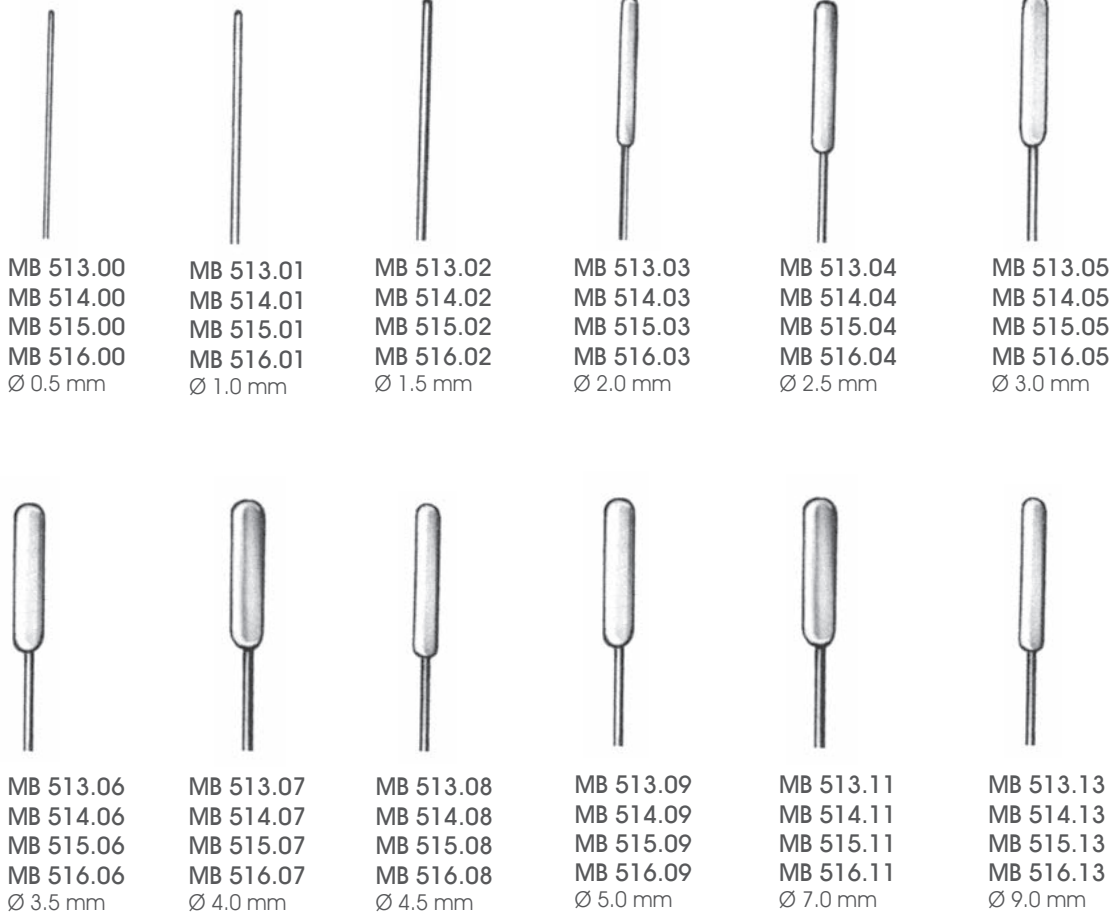

GARRET

MB 513.00-MB 513.13 14 cm

MB 514.00-MB 514.13 19 cm

MB 515.00-MB 515.13 21 cm

MB 516.00-MB 516.13 35 cm

Bükülebilir/Malleable



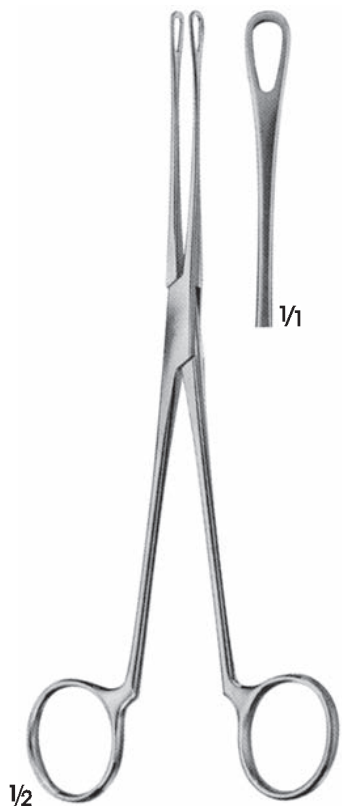

$\frac{1}{2}$
BLAKE
EB 620.00
Emboli tutma pensi
Embolus grasping forceps
20.5 cm

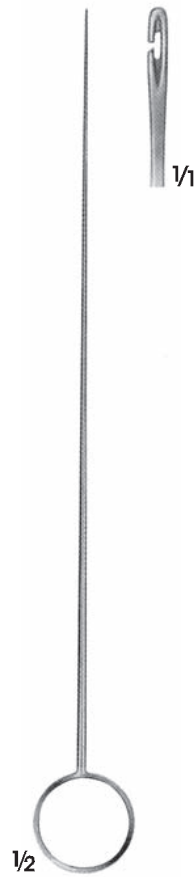

$\frac{1}{2}$
FB 530.05
Sadece klavuz
Guide only



$\frac{1}{2}$
FB 530.06
Sadece klavuz
Guide only



$\frac{1}{2}$
RUMEL-BELMONT
Turnikeler/Tourniquets
FB 530.01 Ø 4.0 mm
FB 530.02 Ø 6.4 mm
32.5 cm

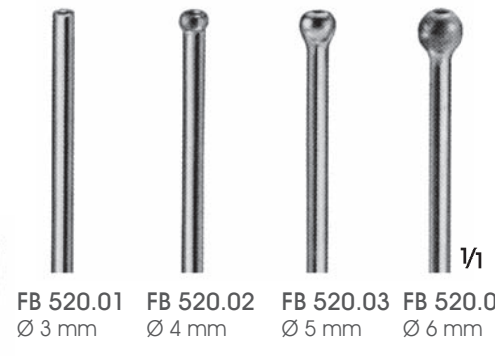
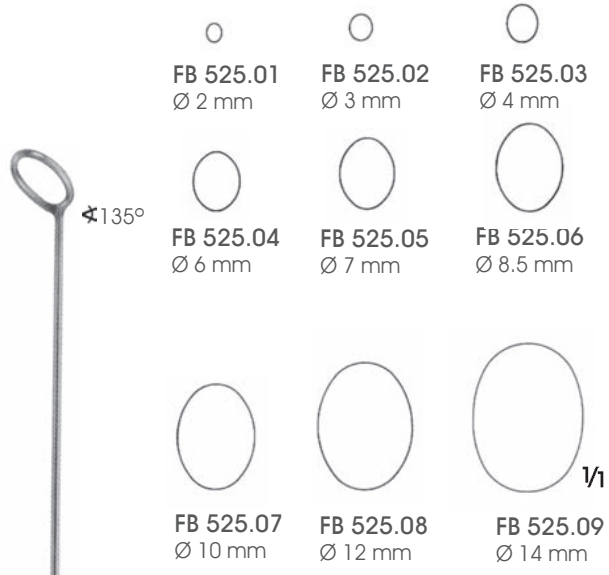
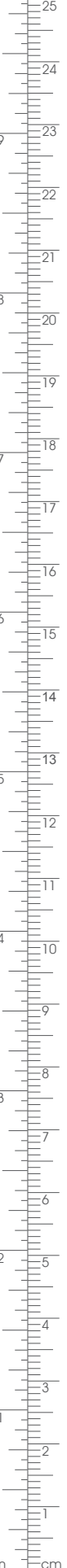

FB 525.12
 FB 525.01-FB 525.09
 Sap/For handle 11
 cm



FB 525.01-FB 525.09
 Endarterektomy temizleyici
 Endarterectomy strippers
 55 cm



SCHMID
FB 520.01-FB 520.04
 Damar sulama kanülleri,
 bükülebilir, gümüş kaplama
 Vessel irrigating cannulae,
 malleable, silver plated
 15 cm

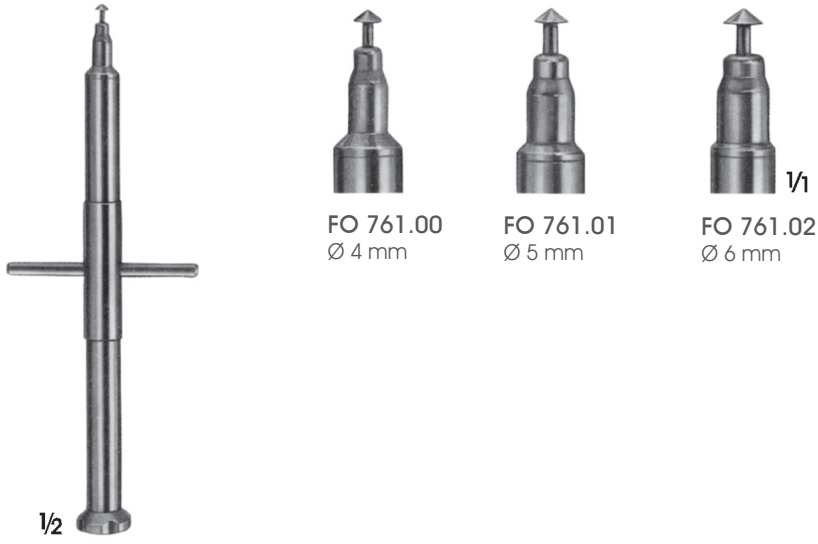

FO 761.00-FO 761.02
Aort pançları/Aorta punches
14 cm

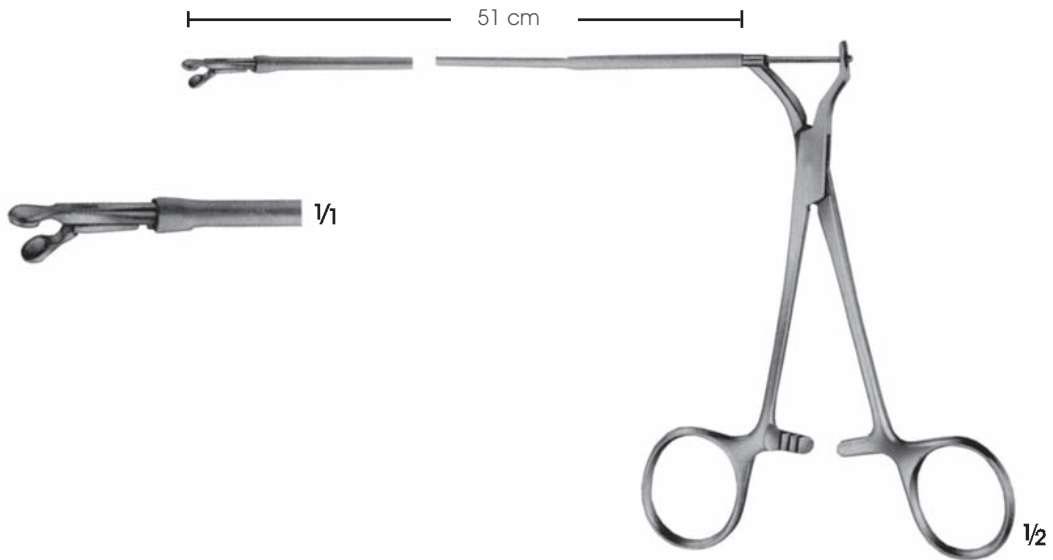

SCHULZ
FB 850.01
Esnek milli biyoptom, 51 cm uzunlugunda
Ø 3 mm yuvarlak çeneli
Biotome, with flexible shaft 51 cm long,
with round jaws Ø 3 mm

Buldog pens sürücüsü, ince ve hafif eğri yapısı ile tünel boyunca kolay ilerleme sağlar.
Buldog pensini güvenli şekilde kavrar.

The slight curvature of the introducer forceps permits handling during tunneling. Here the prosthesis can be drawn in by applying the introducer forceps directly to the prosthesis (alloplastic prosthesis) or can be drawn in by means of the bullog clamp (autologous/homologous prosthesis). Thanks to the interlocking fit, the bulldog clamp rests non-displaceable and securely in the mouth of the introducer forceps.

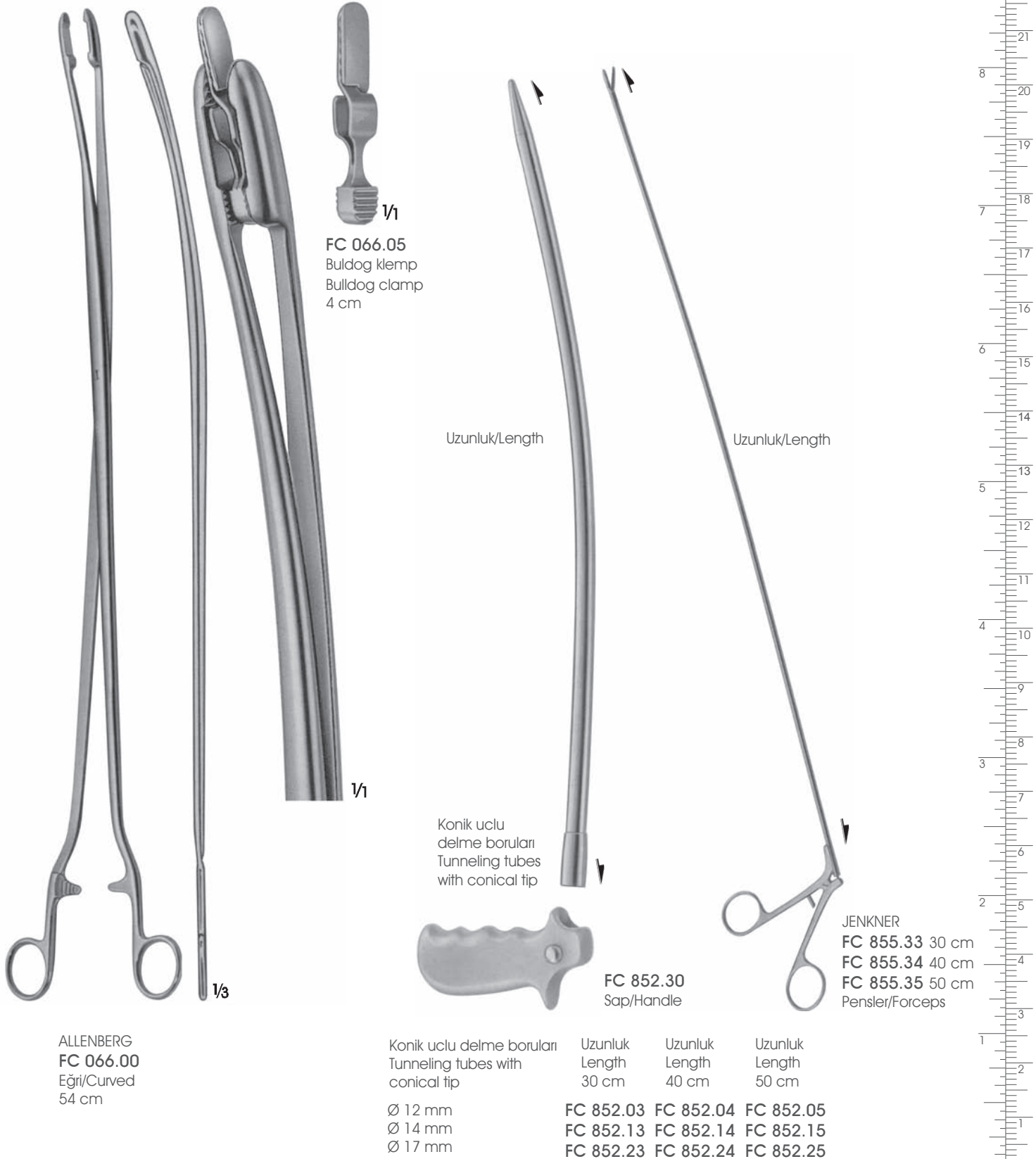



WITT
SR 710.00 1.5 x 35 mm
SR 710.02 1.5 x 51 mm
Sternal delme iğnesi, Luer bağlantılı
Sternal puncture needle with Luer cone

1/1



Tek ağız tırtıllı
One jaw serrated

BRAUN-STADLER
ET 604.01
Çocuklar için Sternum makası
Sternum shears for children
20 cm

1/1

1/2



SCHUMACHER
FB 505.00
Sternum makası
Sternum shears
21 cm

1/2



LEBSCHKE
FB 598.00
Sternum çizili
Sternum chisel
20 cm

1/2



FINSTERER
GF 600.00
Kombine aspiratör ucu
ve irrigasyon kanülü
Combined suction and
irrigation cannula
32 cm



YANKAUER
GF 301.00 Ø 2.0 mm
Merkez delikli/With central bore
28.5 cm



DE BAKEY
GF 304.00
Merkez delikli, Ø 3.0 mm yanıl yuvalı
With central bore, Ø 3.0 mm with lateral slots
27.5 cm



DE BAKEY
GF 306.00
Parmak kumandalı, temizleme teli
With finger cut-off and stylet
27 cm



DE BAKEY
GF 308.00
Parmak kumandalı, temizleme teli
With finger cut-off and stylet
16 cm





SEMBO
FO 135.00
Kaburga ve kemik tutma pens
Rib-and bone holding forceps
19 cm



SEMBO
FO 136.00
Kaburga ve kemik tutma pens
Rib-and bone holding forceps
19 cm



BAILEY
FB 850.00
Göğüs ekartörü/Rib spreader
15 cm



SELLORS
FB 854.01
Göğüs ekartörü/Rib spreader
Oynak bleydli/With swivel blades
20 cm



BAILEY
T 852.00
Çocuklar için
For children

BAILEY
T 852.01
Büyükler için
For adults

BAILEY
FB 852.00-T 852.01
Göğüs ekartörü/Rib spreader
20 cm



SAUERBRUCH
FB 500.01
Çocuklar için
For children
24 cm

FB 500.02
Büyükler için
For adults
27 cm

1/3



GLUCK
FB 510.00
19 cm

1/3



FB 513.01
23 cm



GIERTZ-STILLE
FB 502.01
25 cm

1/3



BRUNNER
FB 520.01
Üniversal model
Universal pattern
34 cm

1/3



BETHUNE
FB 515.00
34 cm

1/3



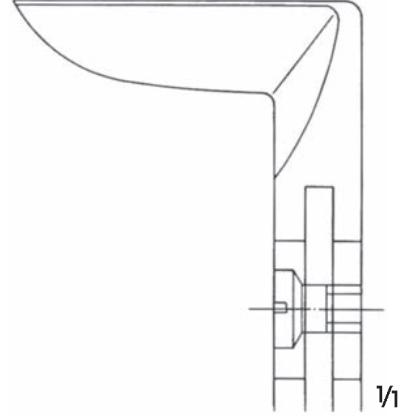
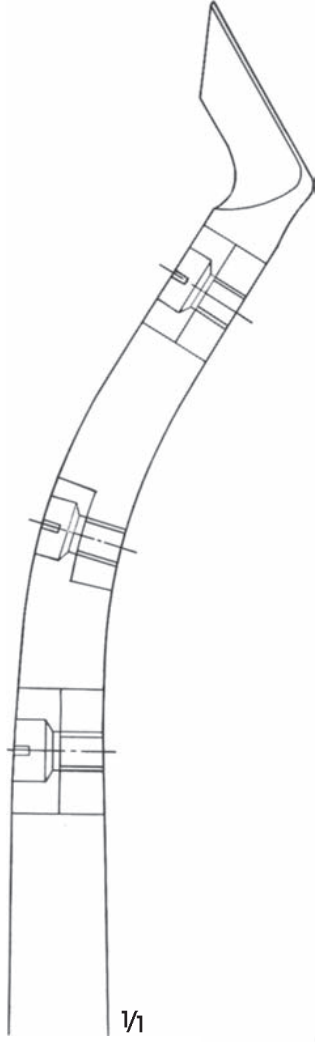

LISTON-KEY-HORSLEY
FO 379.01
S şekilli, arka kaburga uçları için
S-Shaped for posterior rib ends
25.5 cm



LISTON-STILLE
FO 378.01
Açılı/Aggled
26.5 cm

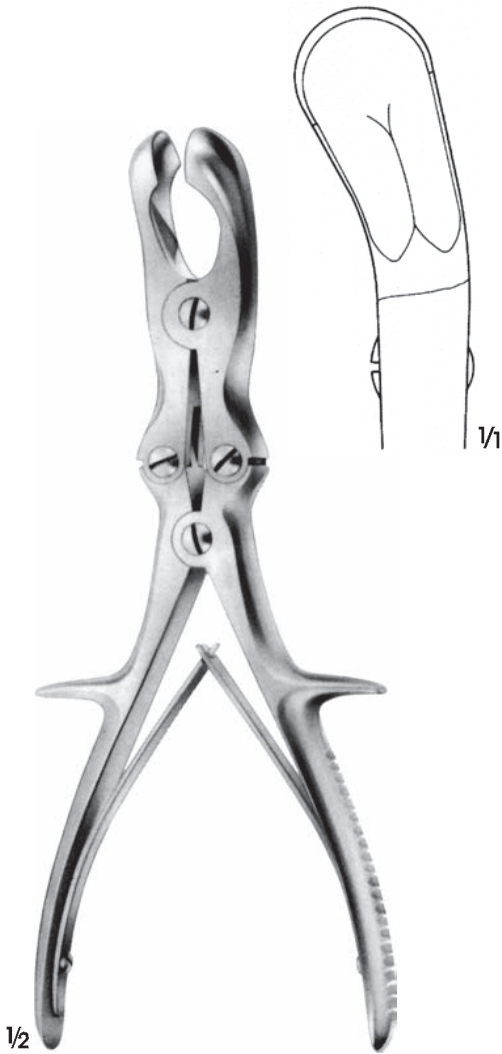

SEMBO
FO 325.01
Kemik ronjur
kaba kemikleri için
Rib rongeur to shorten
the rib stumps
24 cm



SAUERBRUCH-CORYLLOS
FO 333.01-FO 335.01
Kemik ronjur
kaba kemikleri için
Rib rongeur to shorten the
rib stumps
31 cm



FK Raspalar, Disektörler ve Elevatörler
Raspatories, Dissectors and Levers



 **ARGENT**

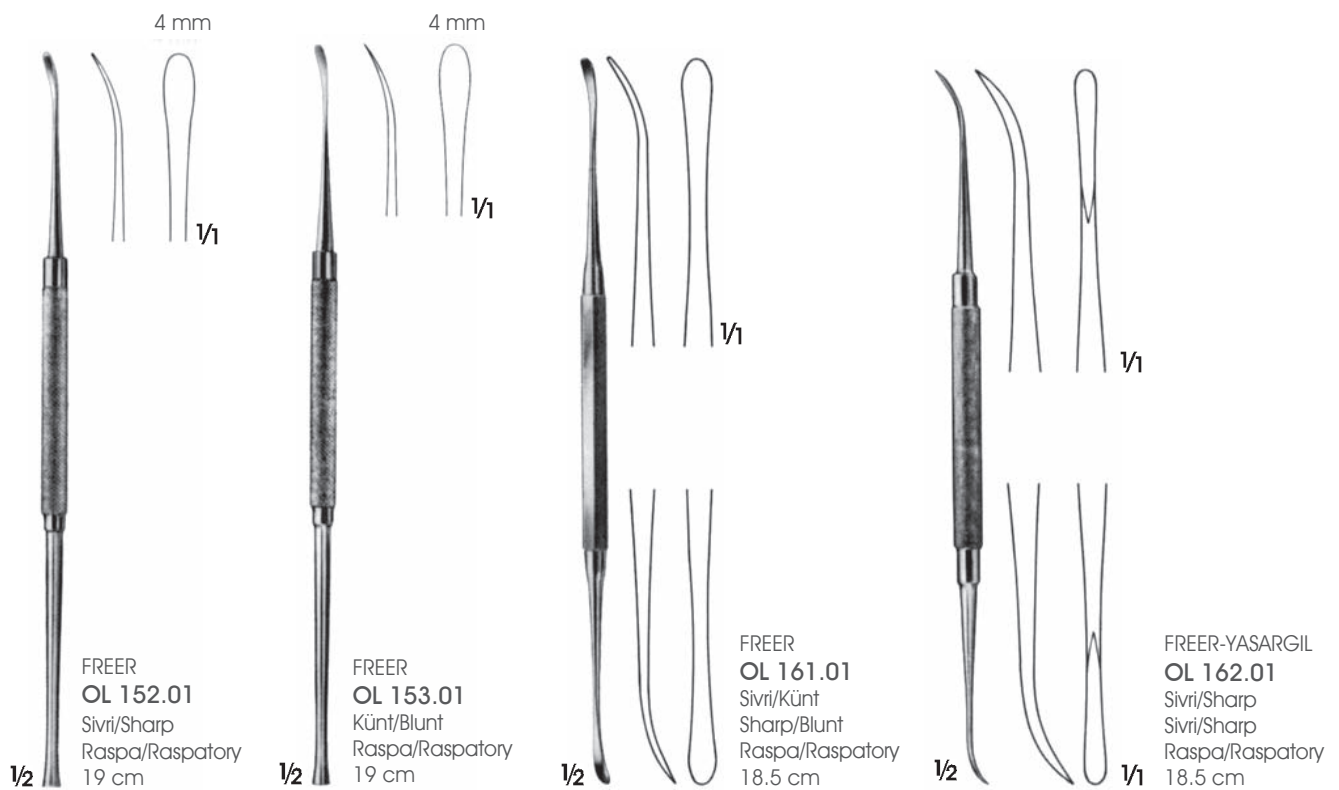
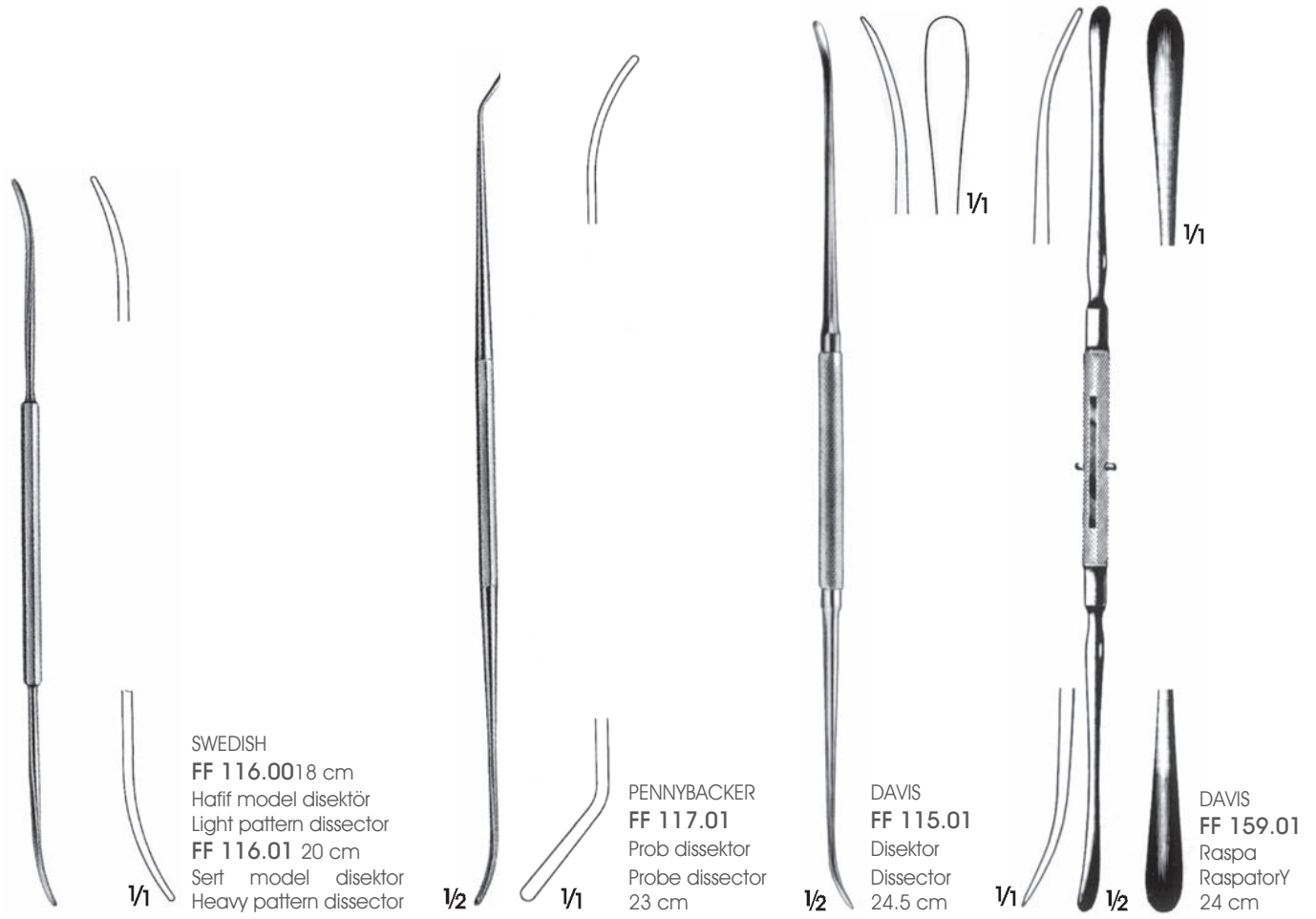

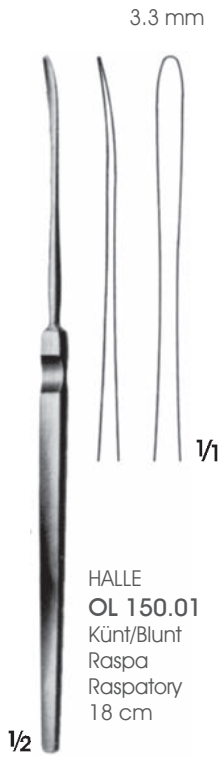

HALLE
OL 150.01
Künt/Blunt
Raspa
Raspatory
18 cm

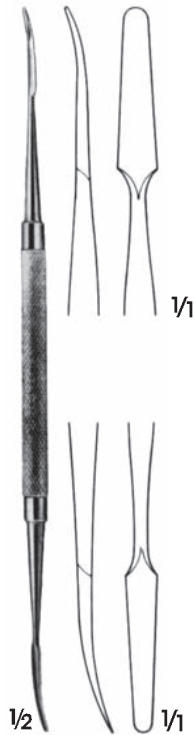

KILLIAN
OL 160.01
Sivri/Sharp
Künt/Blunt
Raspa/Raspatory
18.5 cm

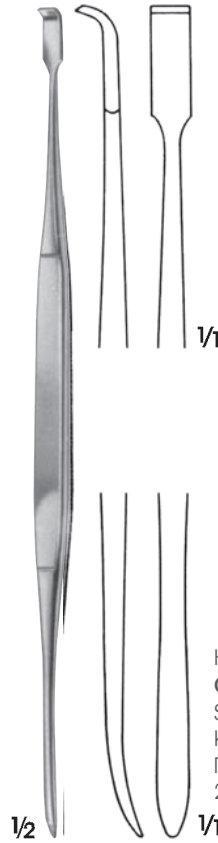

HOWARTH
OL 194.01
Sivri/Sharp
Künt/Blunt
Raspa/Raspatory
21.5 cm



OL 165.01
Disektor
Dissector
22 cm



OL 166.01
Raspa
Raspatory
22 cm



SEWALL
OL 170.01
Künt/Blunt
Raspa/Raspatory
20 cm



CASPAR
FF 130.01
Raspa/Raspatory
20 cm



PENFIELD
FF 154.01
Raspa/Raspatory
20.5 cm



SACHS
FF 180.01
Raspa/Raspatory
21 cm



CASPAR
FF 130.02
Disektor/Dissector
23 cm

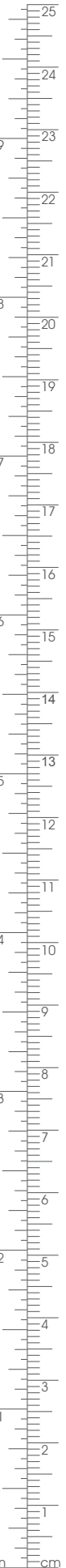

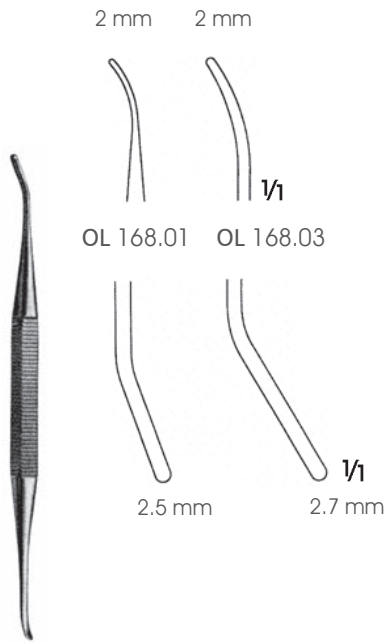

2 mm 2 mm
OL 168.01 OL 168.03
1/1

2.5 mm 2.7 mm
1/1

WATSON-CHEYNE
OL 168.01 13 cm
OL 168.03 19 cm
Raspalar/Raspatory

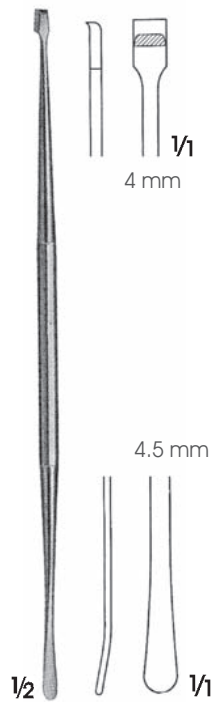

1/2 1/1
4 mm
4.5 mm
FREER
OL 167.00
Raspa/Raspatory 18 cm

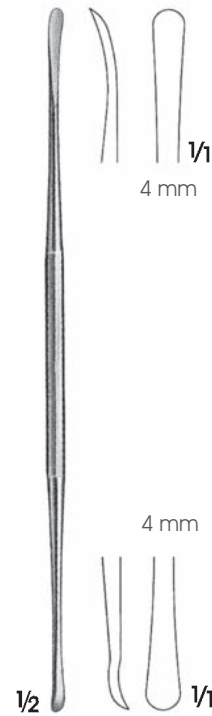

1/2 1/1
4 mm
4 mm
SYME
OL 169.00 Sivri/Sharp
Raspa/Raspatory 18.5 cm

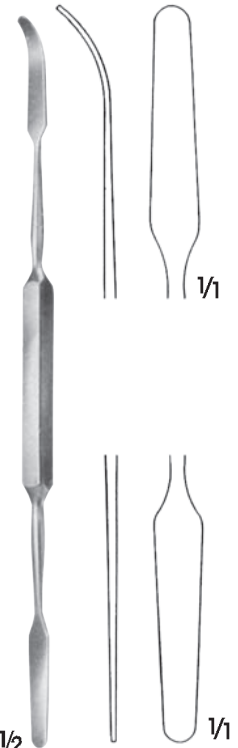

1/2 1/1
MAC DONALD
FK 190.01
Künt/Blunt
Künt/Blunt
Dissektor/ Dissector
18.5 cm

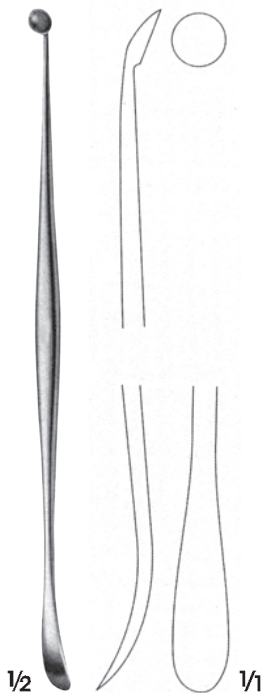

1/2 1/1
PENFIELD
FF 178.00
Dissektor/Dissector
Çif uçlu/Double-Ended
17.5 cm

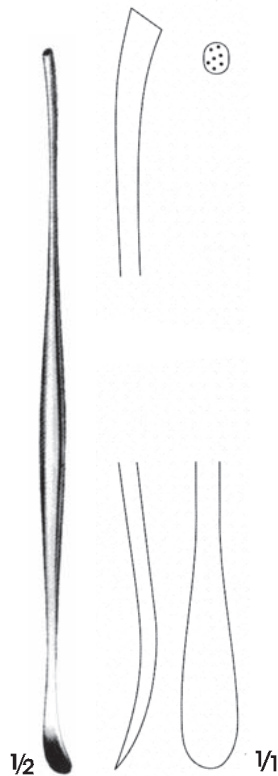

1/2 1/1
PENFIELD
FF 175.01 Fig.2
Dissektor/Dissector
Çif uçlu/Double-Ended
19.5 cm

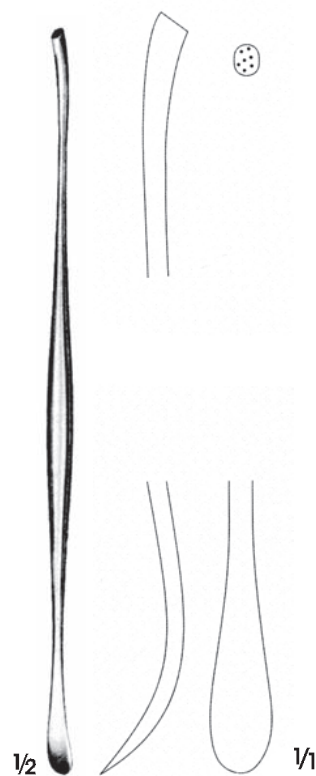

1/2 1/1
PENFIELD
FF 175.02 Fig.3
Dissektor/Dissector
Çif uçlu/Double-Ended
19.5 cm



1/2 1/1
CARTER
FF 179.01
Raspa/Raspatory
21 cm



FRAZIER
MF 182.00
Raspa/Raspatory
15 cm



HOEN
MF 182.01
Raspa/Raspatory
15 cm



HOEN
MF 182.02
Raspa/Raspatory
15 cm



FREER
FF 177.01
Raspa/Raspatory
20 cm

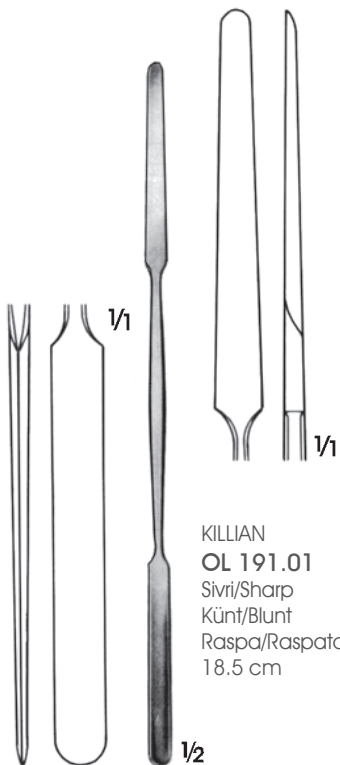

KILLIAN
OL 191.01
Sivri/Sharp
Künt/Blunt
Raspa/Raspatory
18.5 cm

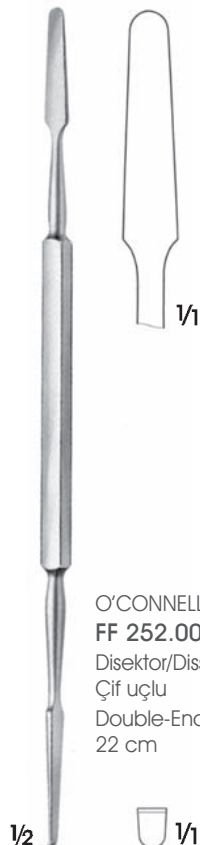

O'CONNELL
FF 252.00
Disektor/Dissector
Çif uçlu
Double-Ended
22 cm



MILLIGAN
MF 188.01
Raspa/Raspatory
21 cm



WOODSON
MF 189.01
Raspa/Raspatory
25 cm

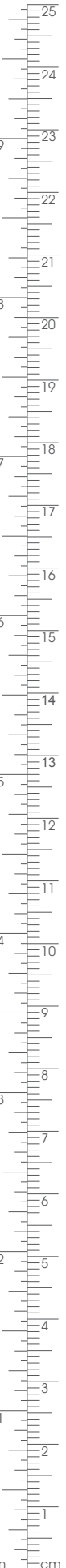

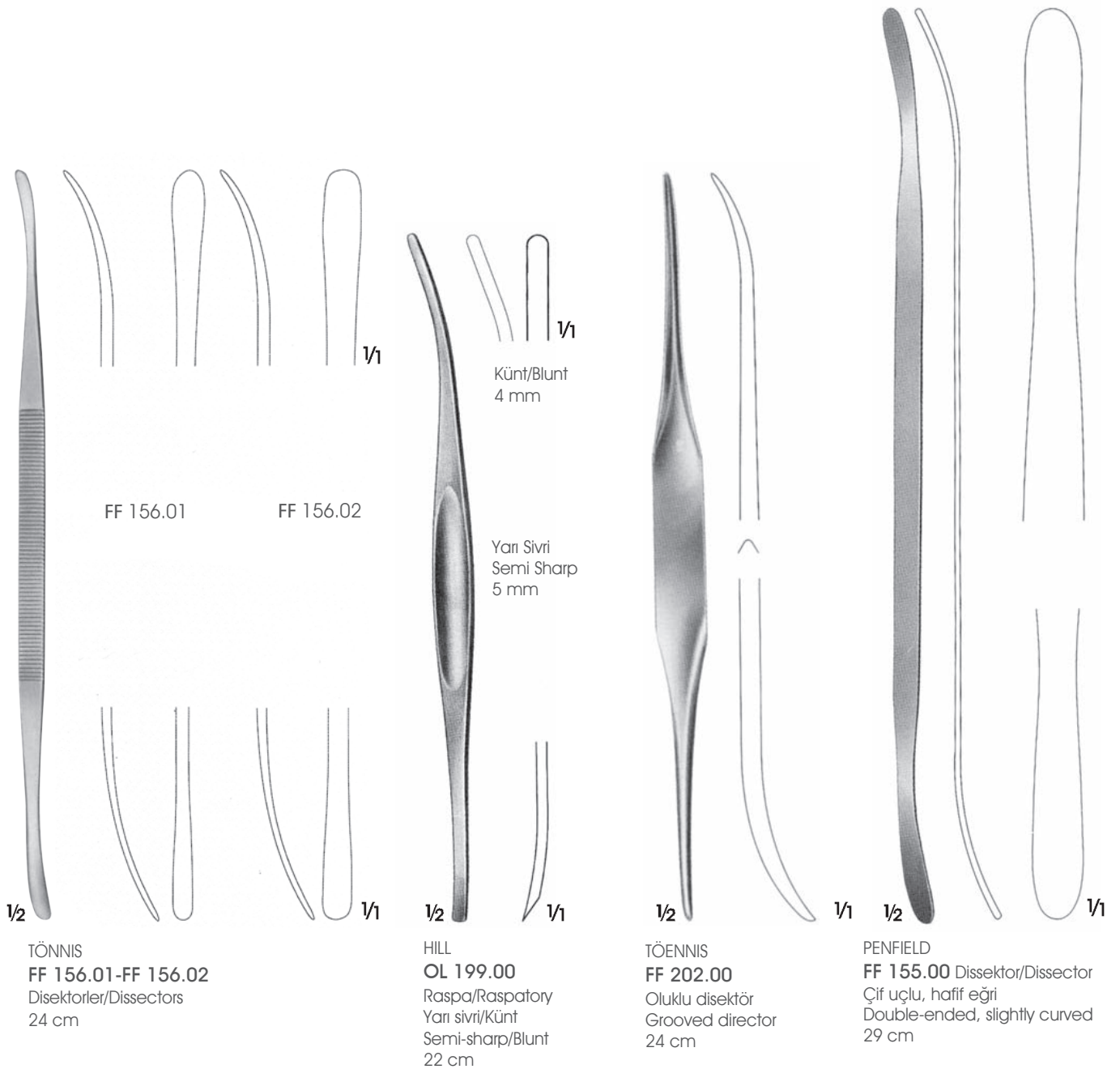

FF 156.01

FF 156.02

Künt/Blunt
4 mm

Yarı Sivri
Semi Sharp
5 mm

1/2

1/1

1/1

1/2

1/1

1/2

1/1

1/2

1/1

TÖNNIS
FF 156.01-FF 156.02
 Disektörler/Dissectors
 24 cm

HILL
OL 199.00
 Raspa/Raspatory
 Yarı sivri/Künt
 Semi-sharp/Blunt
 22 cm

TÖNNIS
FF 202.00
 Oluklu disektör
 Grooved director
 24 cm

PENFIELD
FF 155.00 Dissektor/Dissector
 Çift uçlu, hafif eğri
 Double-ended, slightly curved
 29 cm

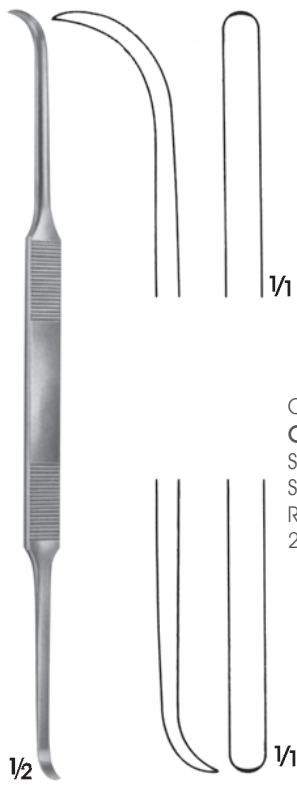

COTTLE
OL 193.01
Sivri/Sharp
Sivri/Sharp
Raspa/Raspatory
20 cm



COTTLE
OL 196.01
Sivri/Sharp
Sivri/Sharp
Sivri/Sharp
Elavator/Elavator
20 cm



PENNINGTON
OL 197.01
Sivri/Sharp
Sivri/Sharp
Sivri/Sharp
Elavator/Elavator
21 cm



PIERCE
OL 198.01
Sivri/Sharp
Sivri/Sharp
Sivri/Sharp
Raspa/Raspatory
21 cm

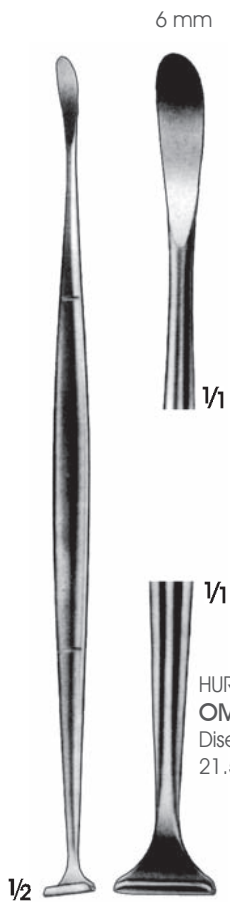

HURD
OM 205.02
Disektor/Dissector
21.5 cm



HURD
OM 205.04
Disektor/Dissector
21.5 cm

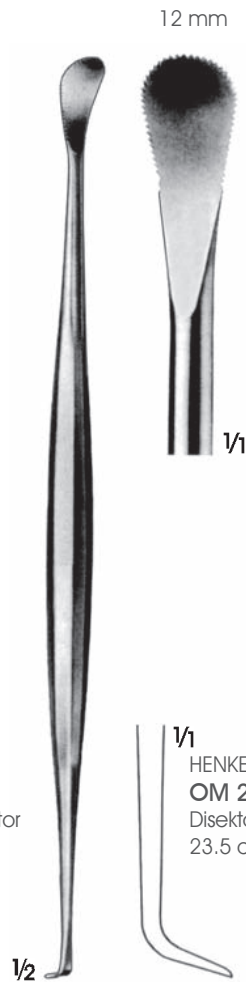

HENKE
OM 208.02
Disektor/Dissector
23.5 cm

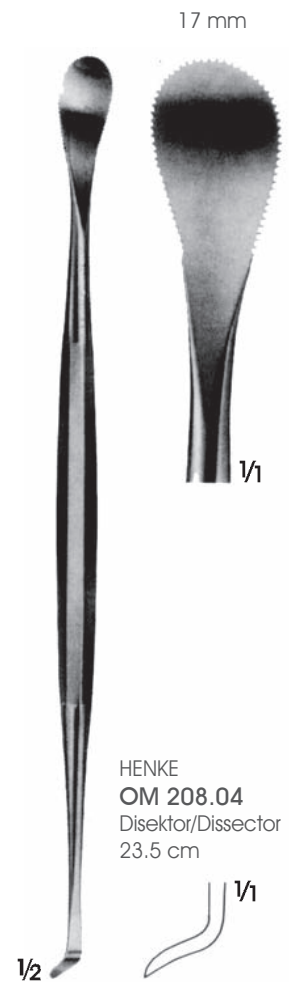

HENKE
OM 208.04
Disektor/Dissector
23.5 cm

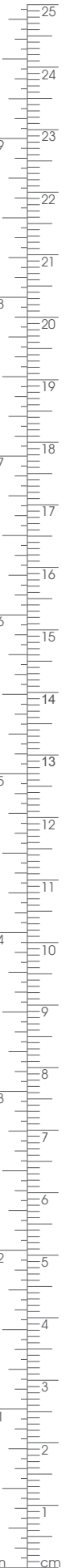

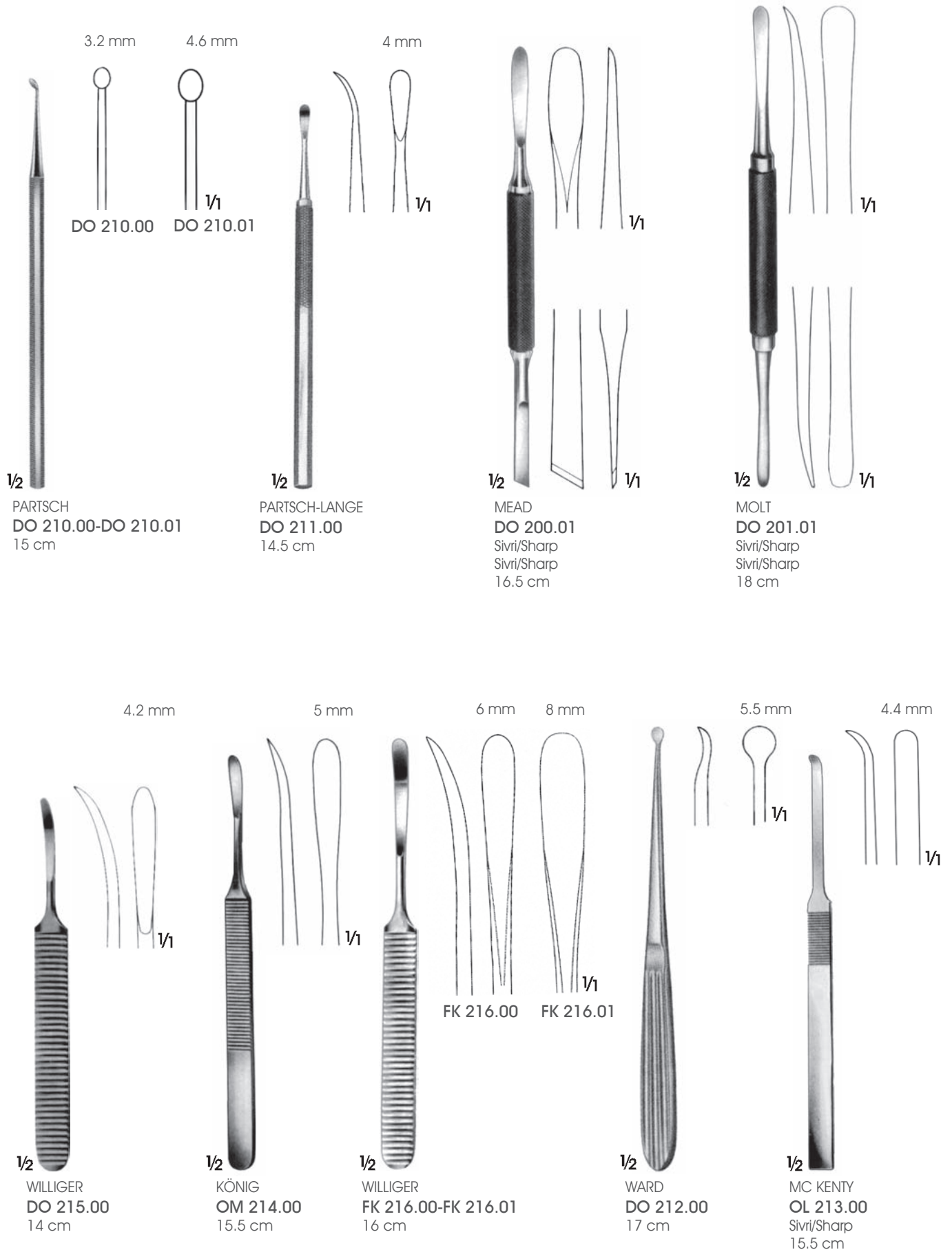

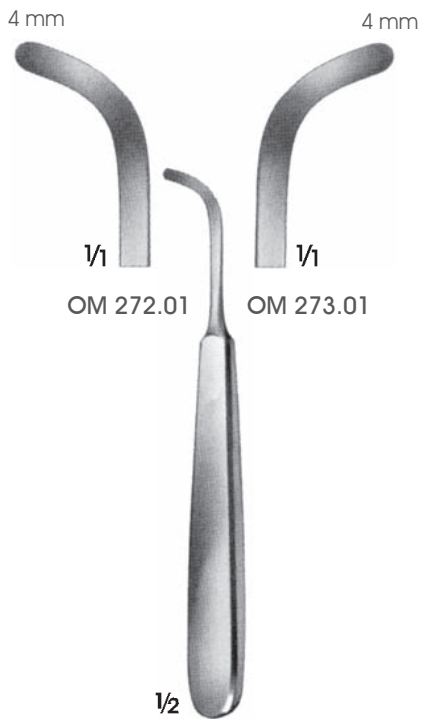

OM 272.01 OM 273.01

OM 272.01-M
273.01 14 cm

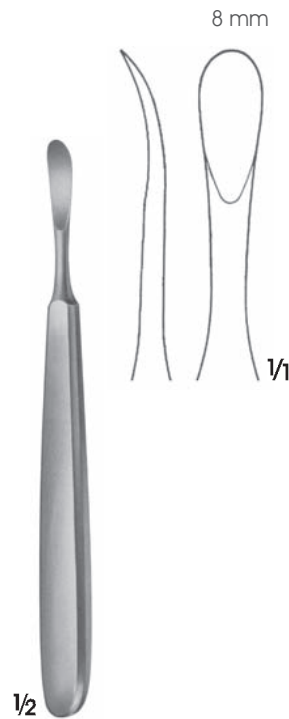

TRELAT
OM 218.00
15 cm

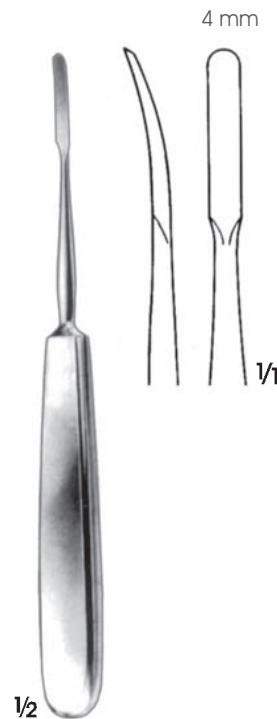

JOSEPH
FK 219.01
17 cm

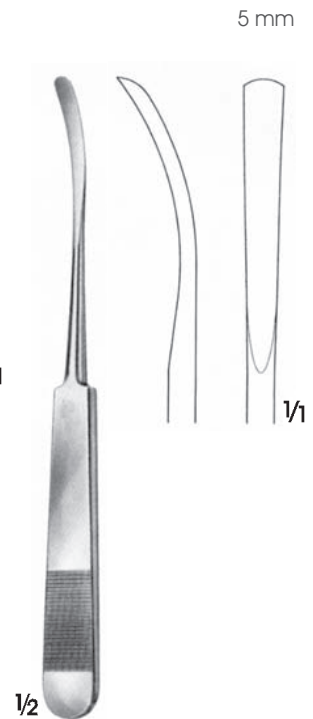

ADSON
FK 237.10
16.5 cm

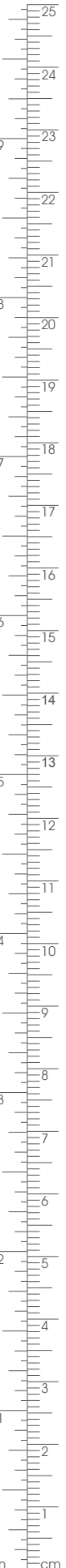

LEMPERT
OG 328.01
Künt/Blunt
16.5 cm

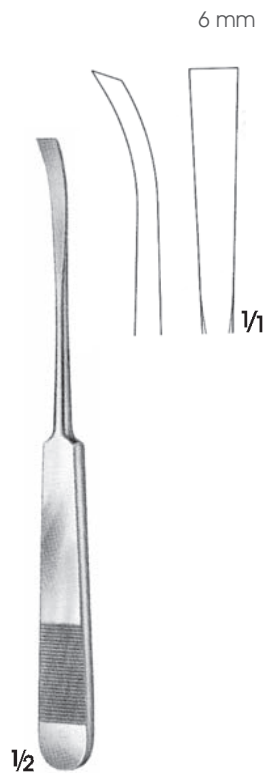

PENNYBAKER
FK 238.00
Künt/Blunt
16.5 cm

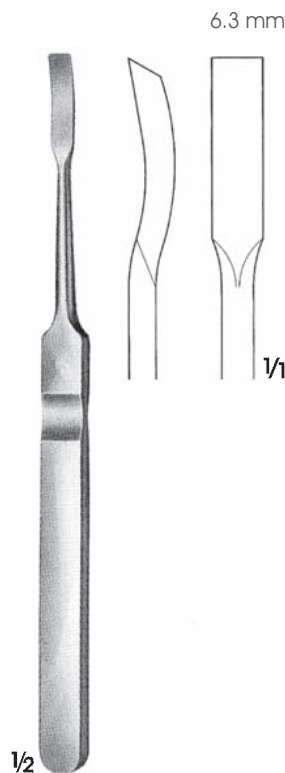

LEMPERT
OG 279.00
Yarı sivri/Semi-sharp
18.5 cm

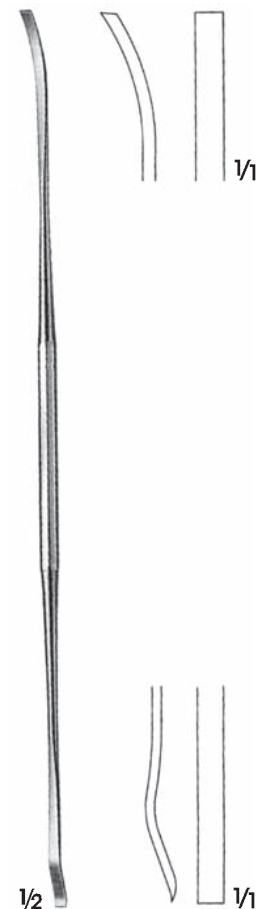

ALLEN
FL 614.00
Osteofit çizil ve raspa
Osteophyte chisel and scraper
23 cm

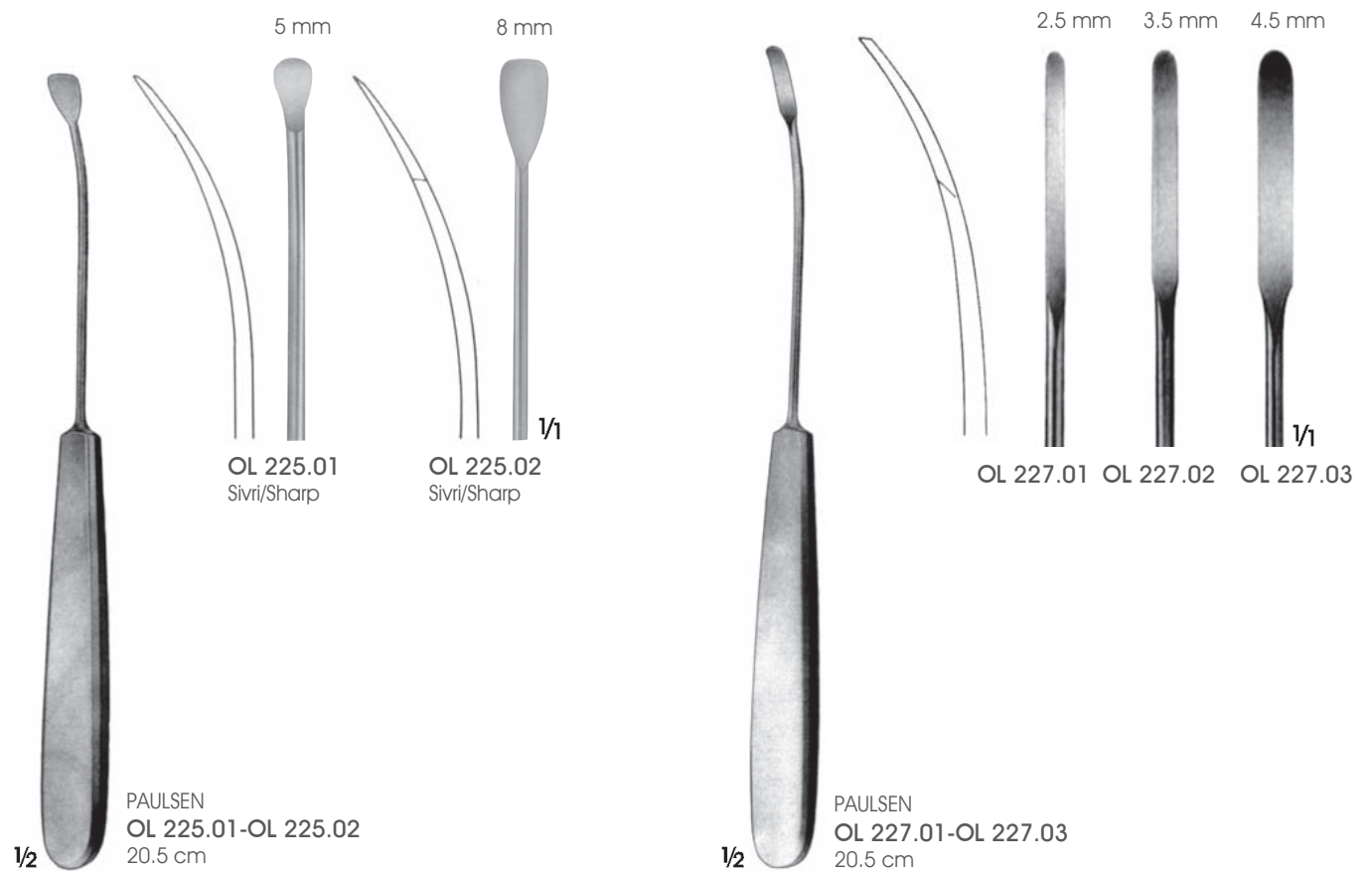
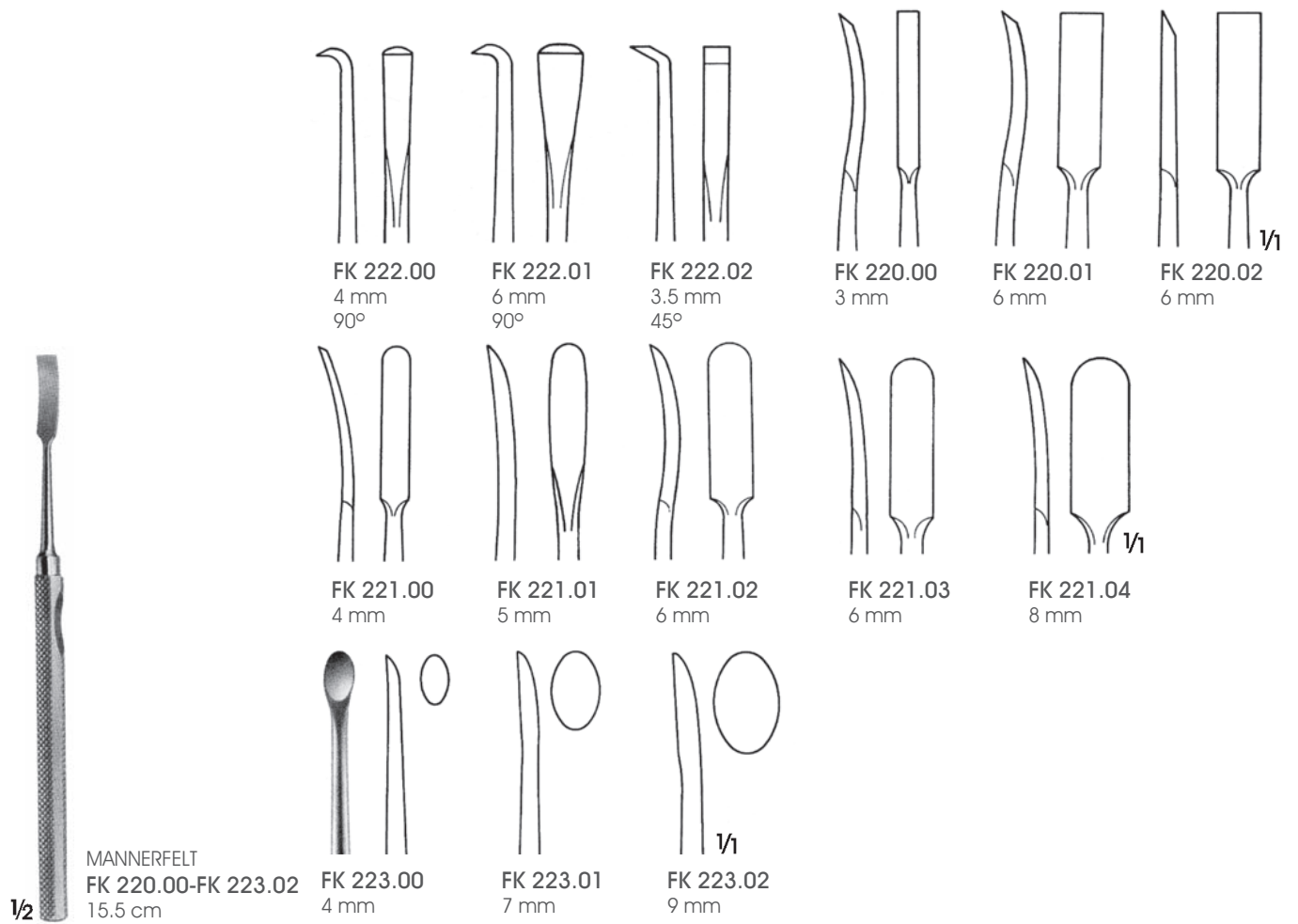

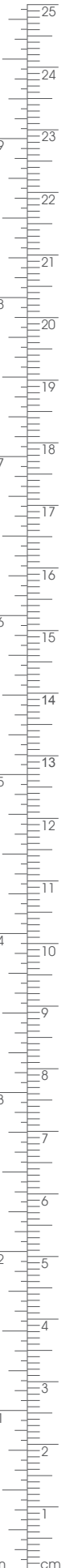
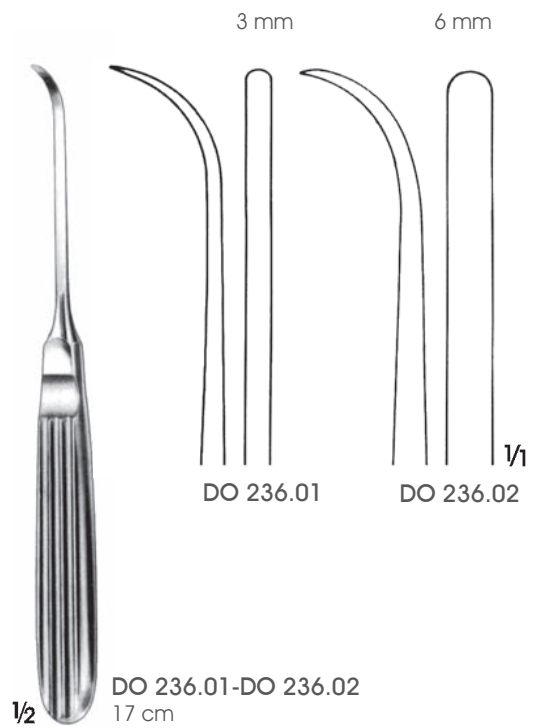
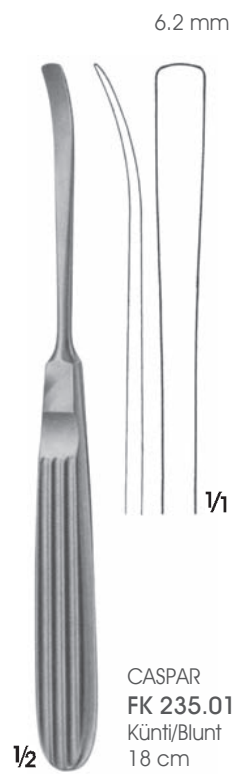
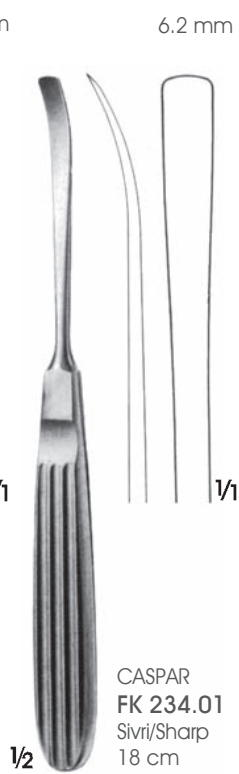
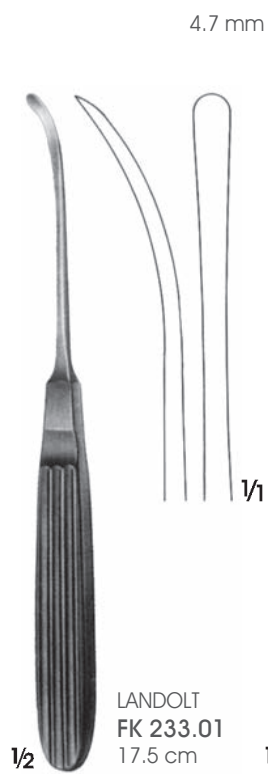
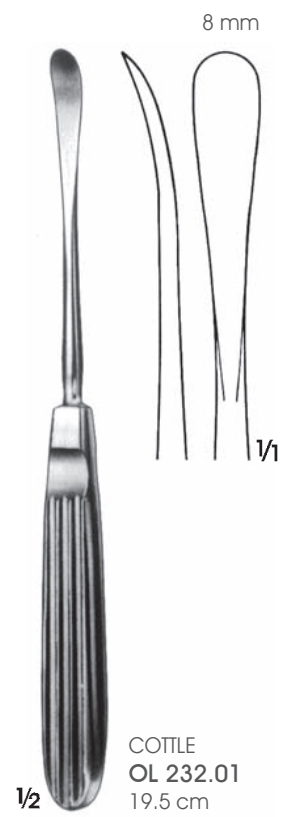
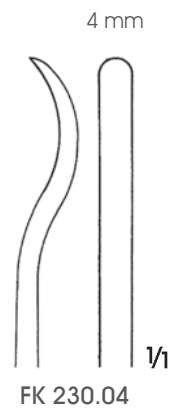
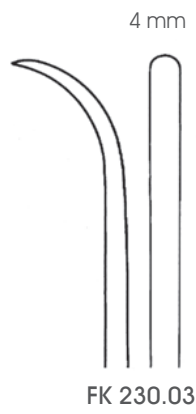
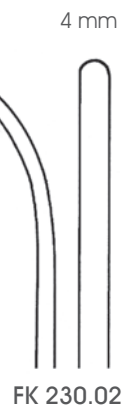

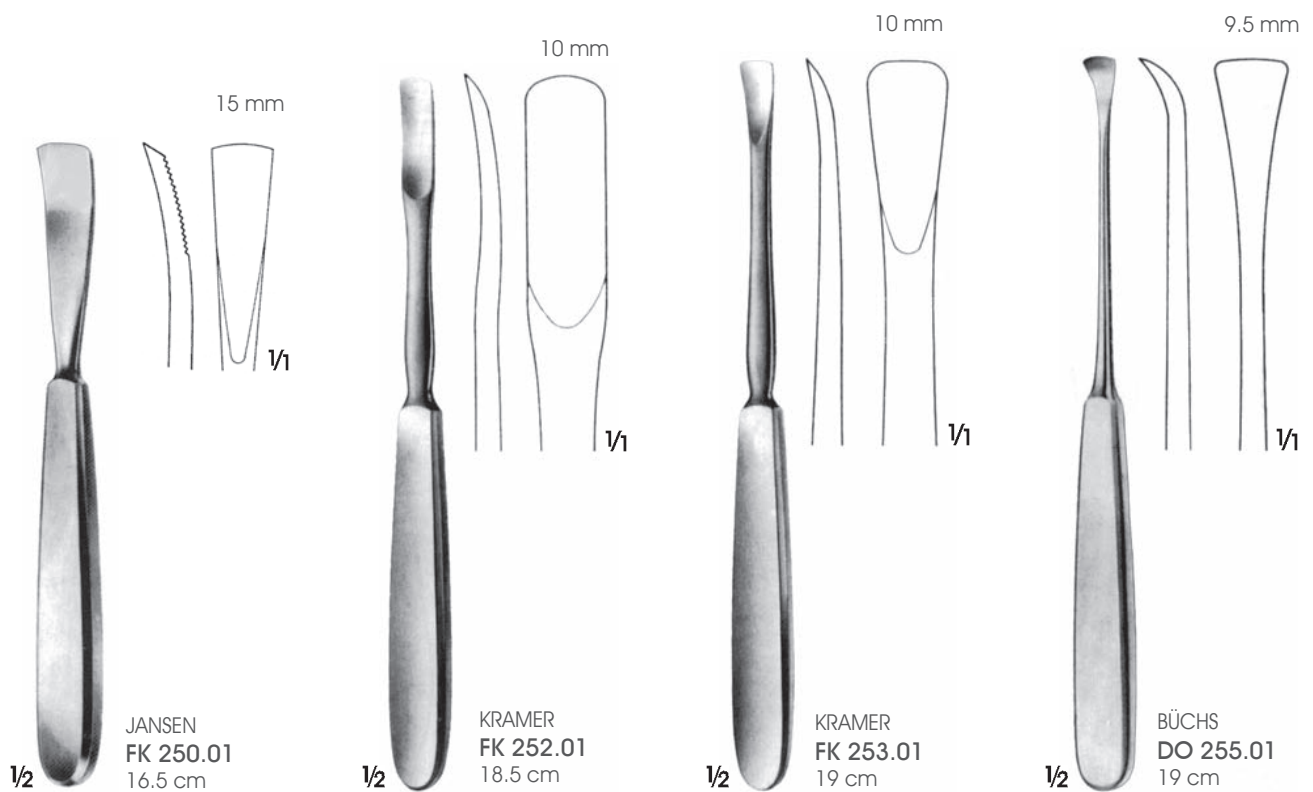
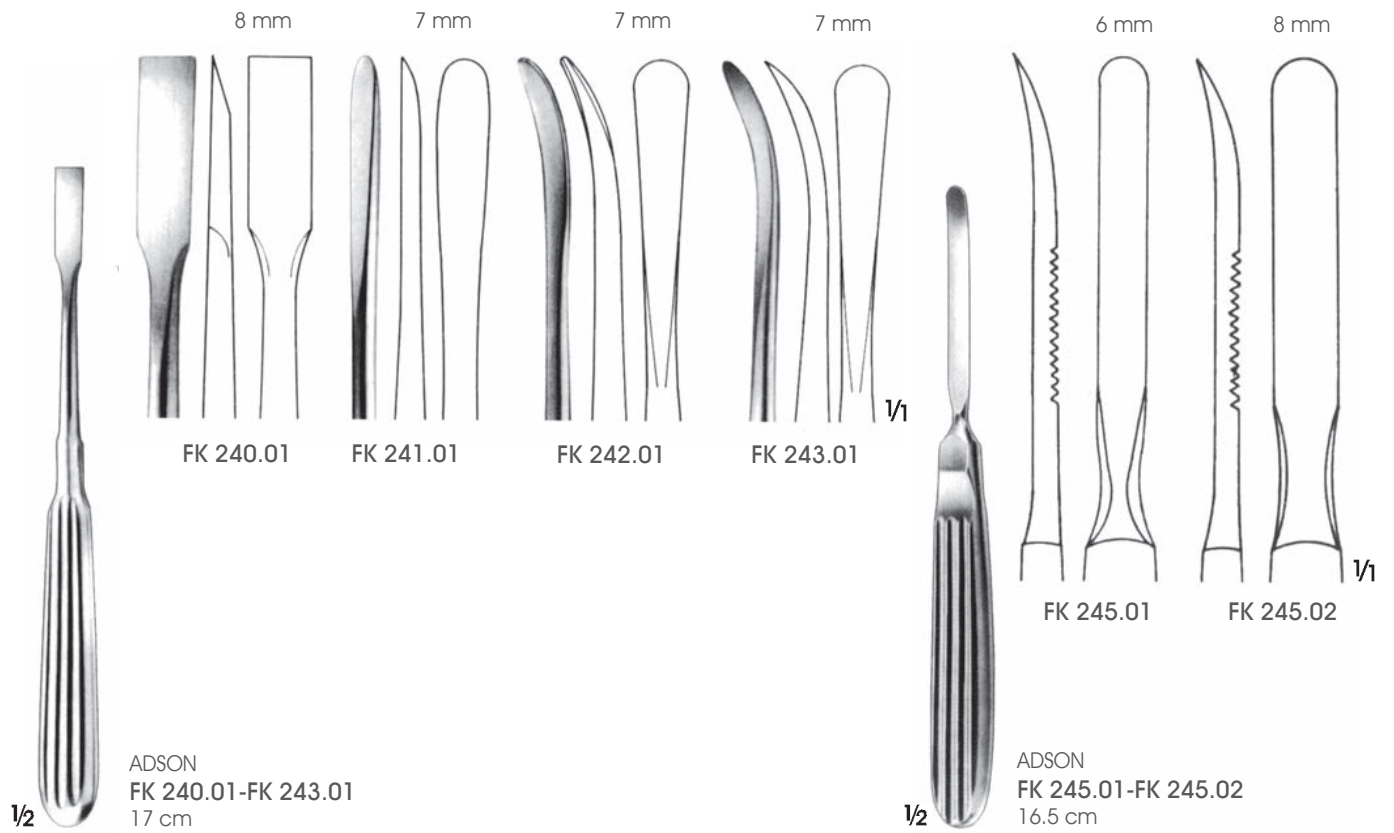

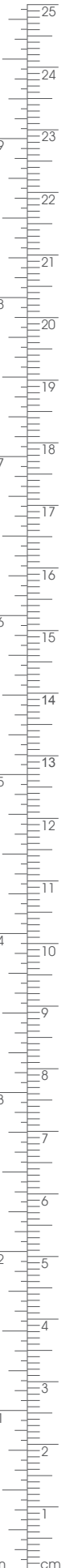
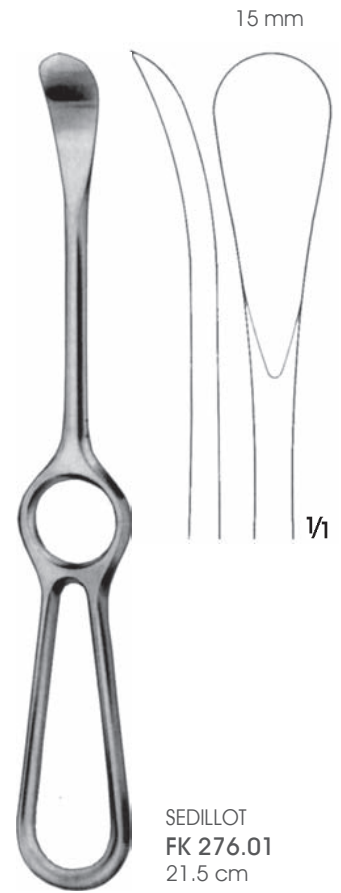
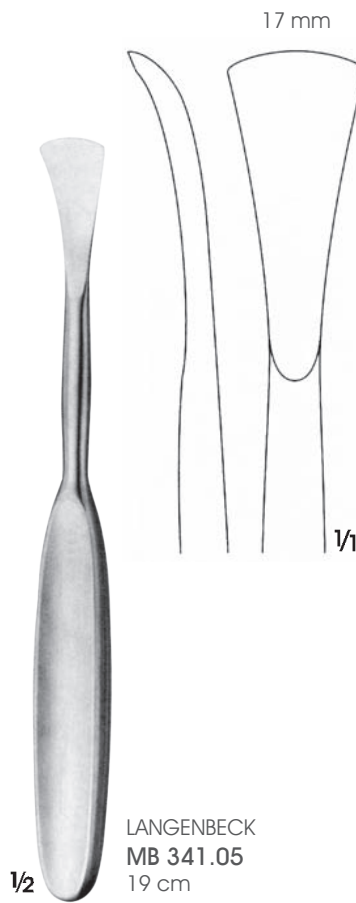
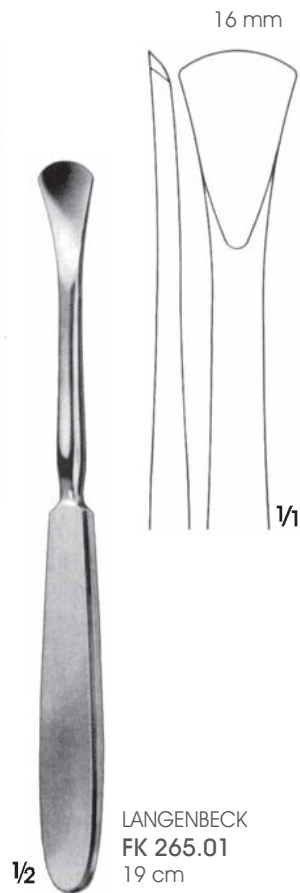
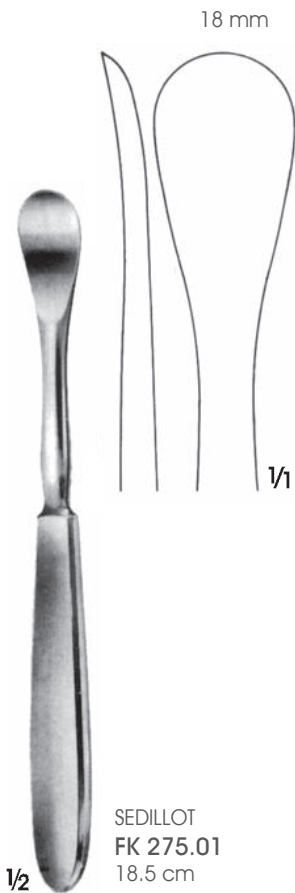
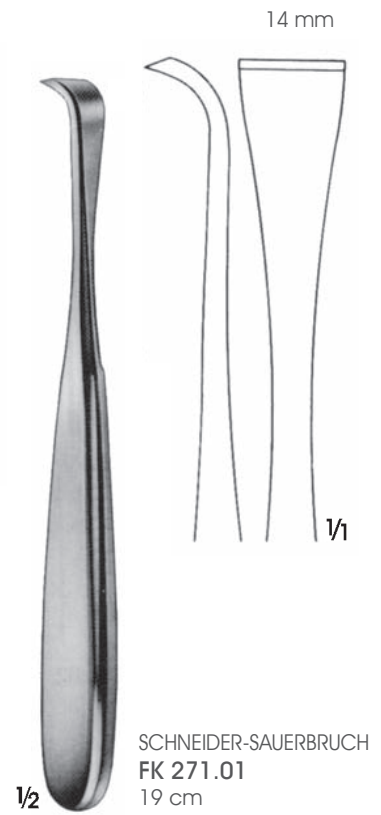
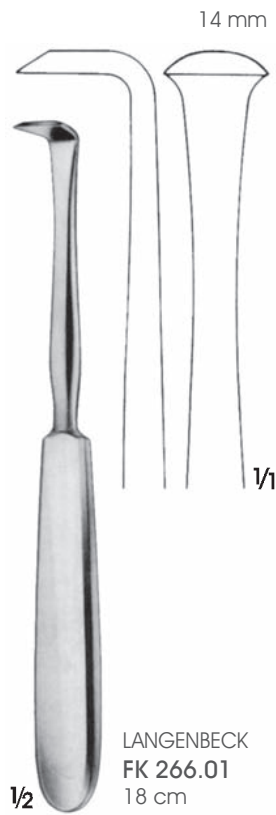
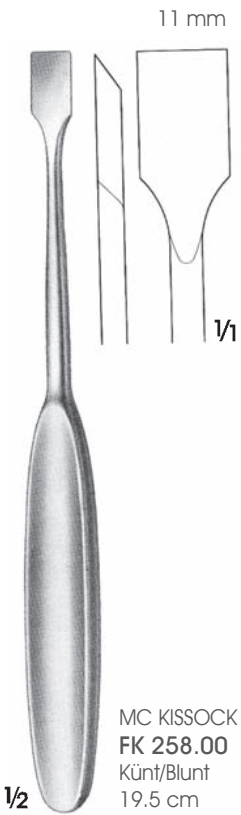

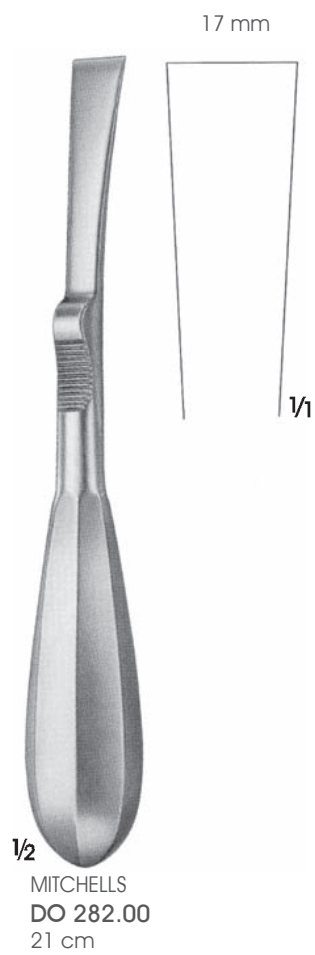
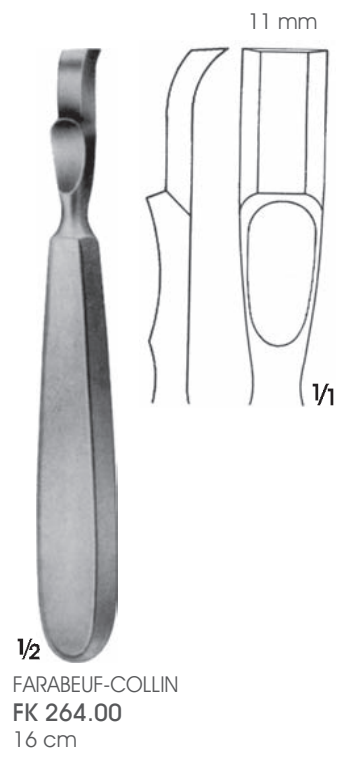
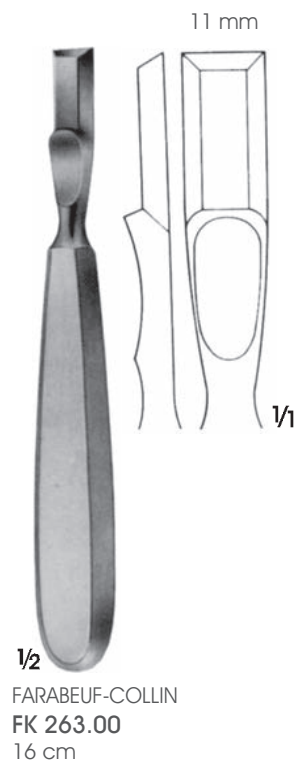
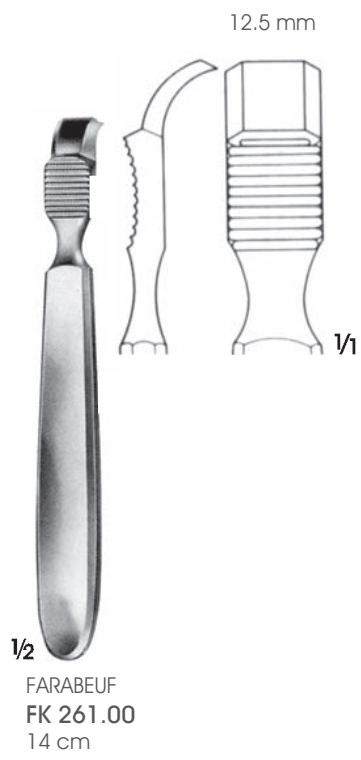
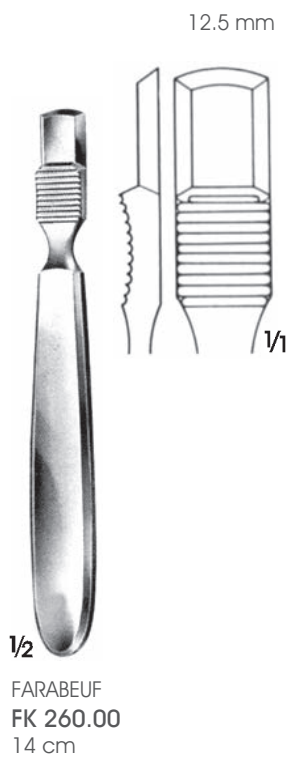

- FK 278.01 5 mm
- FK 278.02 10 mm
- FK 278.03 15 mm
- FK 278.04 20 mm
- FK 278.05 25 mm

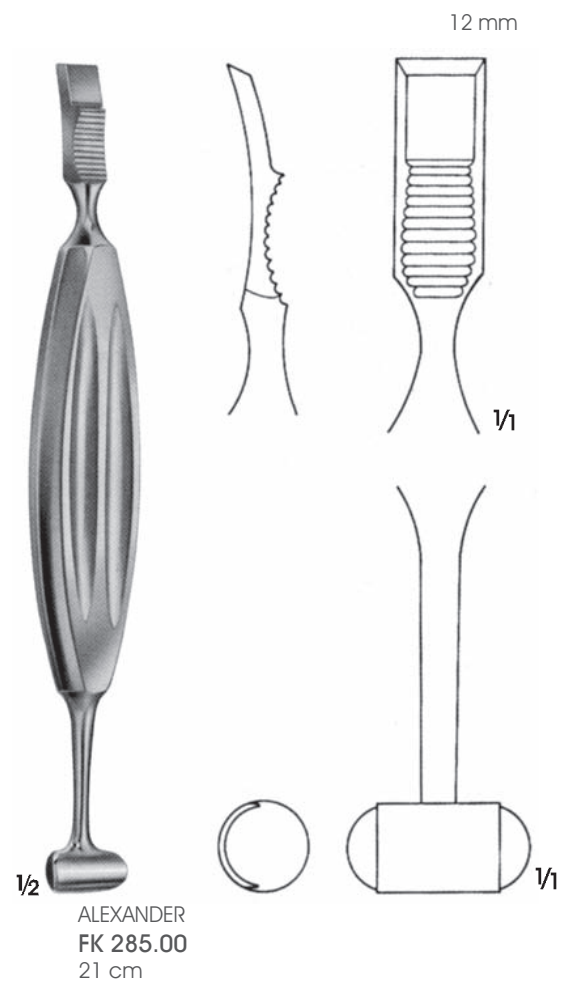

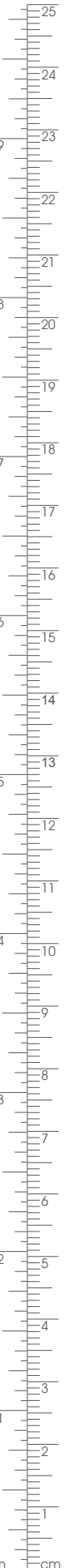
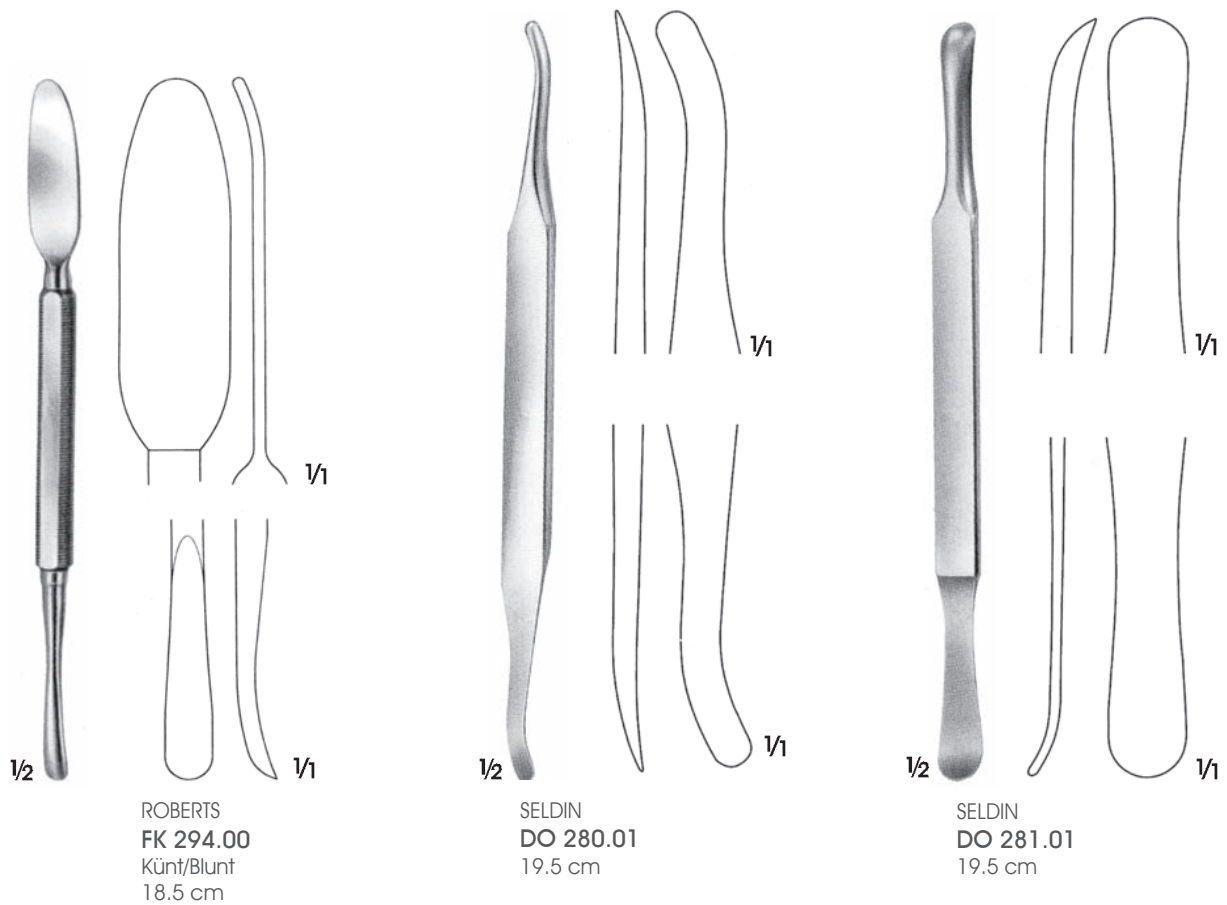

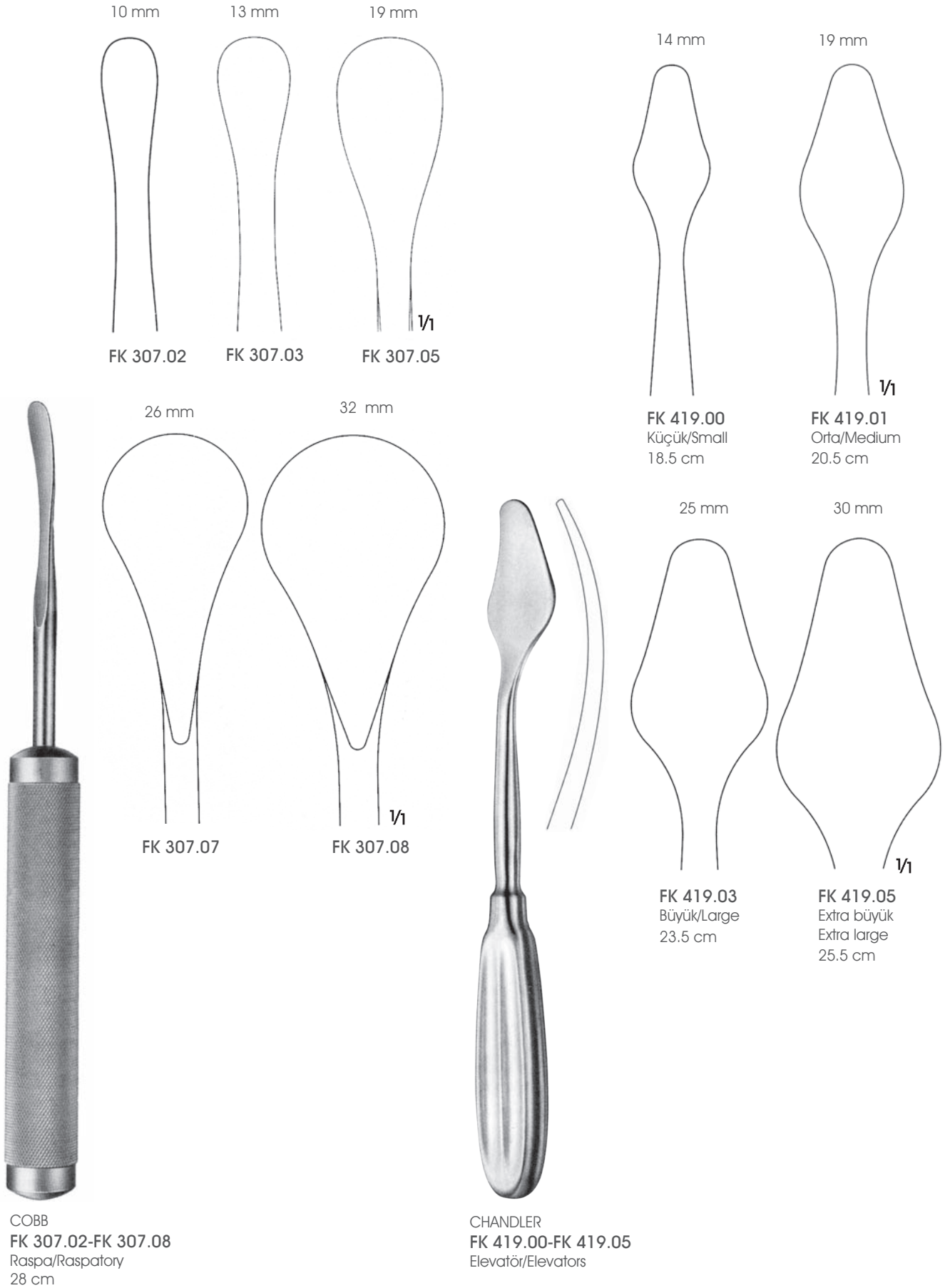



KEY
FK 300.02-FK 300.14

	Genişlik Wid th	Boy Uzunluk
FK 300.11	6 mm	18 cm
FK 300.05	10 mm	19 cm
FK 300.02	13 mm	19 cm
FK 300.13	19 mm	20 cm
FK 300.14	25 mm	21 cm



COBB
FK 305.01-FK 305.03
24 cm



19 mm
FK 305.03



13 mm
FK 305.02



10 mm
FK 305.01



8 mm
FK 306.03



6 mm
FK 306.02

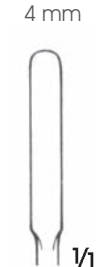

4 mm
FK 306.01



COBB
FK 306.01-FK 306.03
27 cm

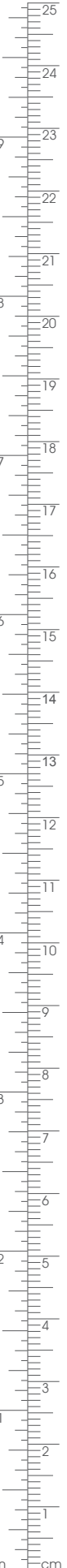

143° buhar sterilizörlerinde steril edilebilir.
Can be sterilized in a steam sterilizer up to 143°

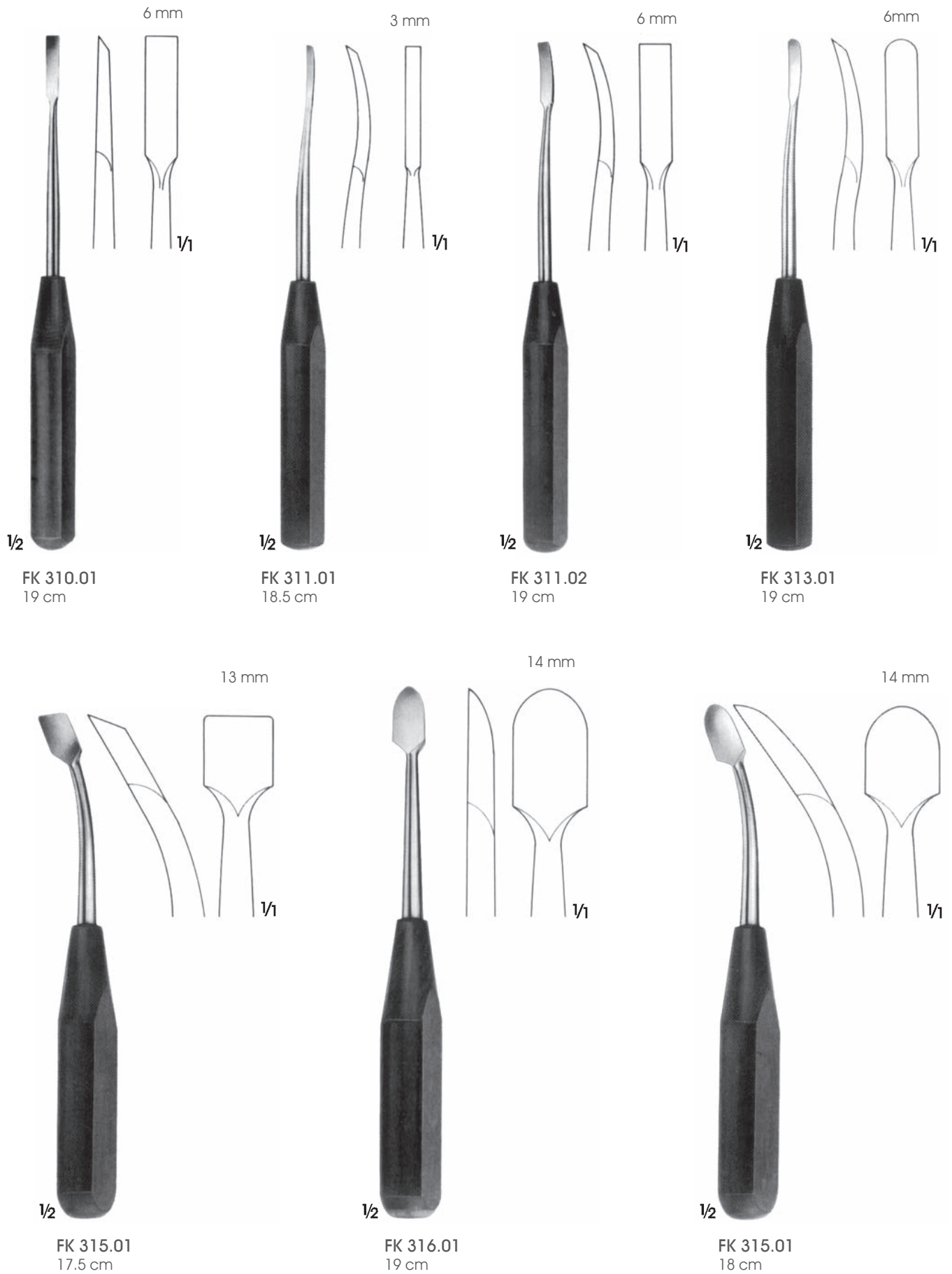

143° buhar sterilizatörlerinde steril edilebilir.
Can be sterilized in a steam sterilizer up to 143°



FK 310.01P
19 cm



FK 311.01P
18.5 cm



FK 313.02P
19 cm

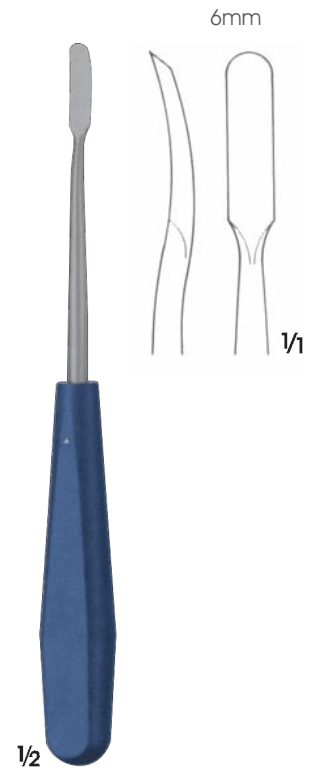

FK 313.01P
19 cm



FK 315.01P
17.5 cm



FK 316.01P
19 cm

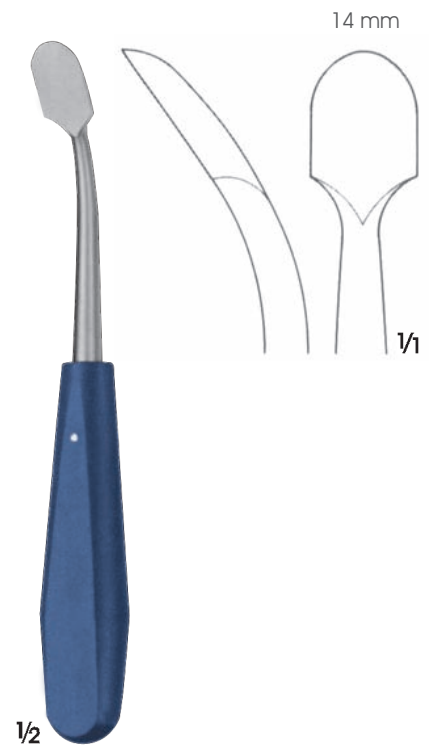

FK 317.01P
18 cm





DOYEN
FK 290.01-FK 291.01
Çocuklar için/For children
17.5 cm



DOYEN
FK 290.02-FK 291.02
Yetişkimler için/For adults
17.5 cm

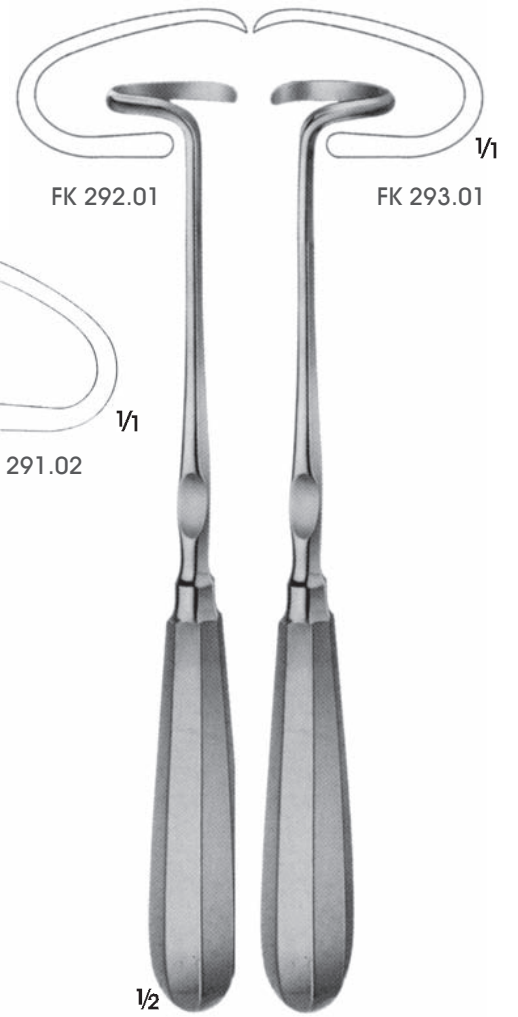

DOYEN
FK 292.01-FK 293.01
24 cm

143° buhar sterilizatörlerin de steril edilebilir.
Can be sterilized in a steam sterilizer up to 143°

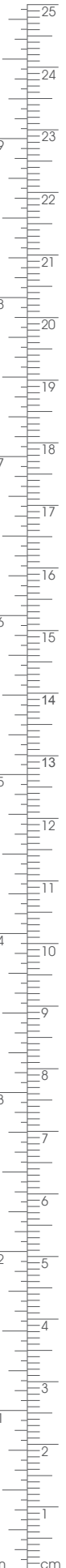

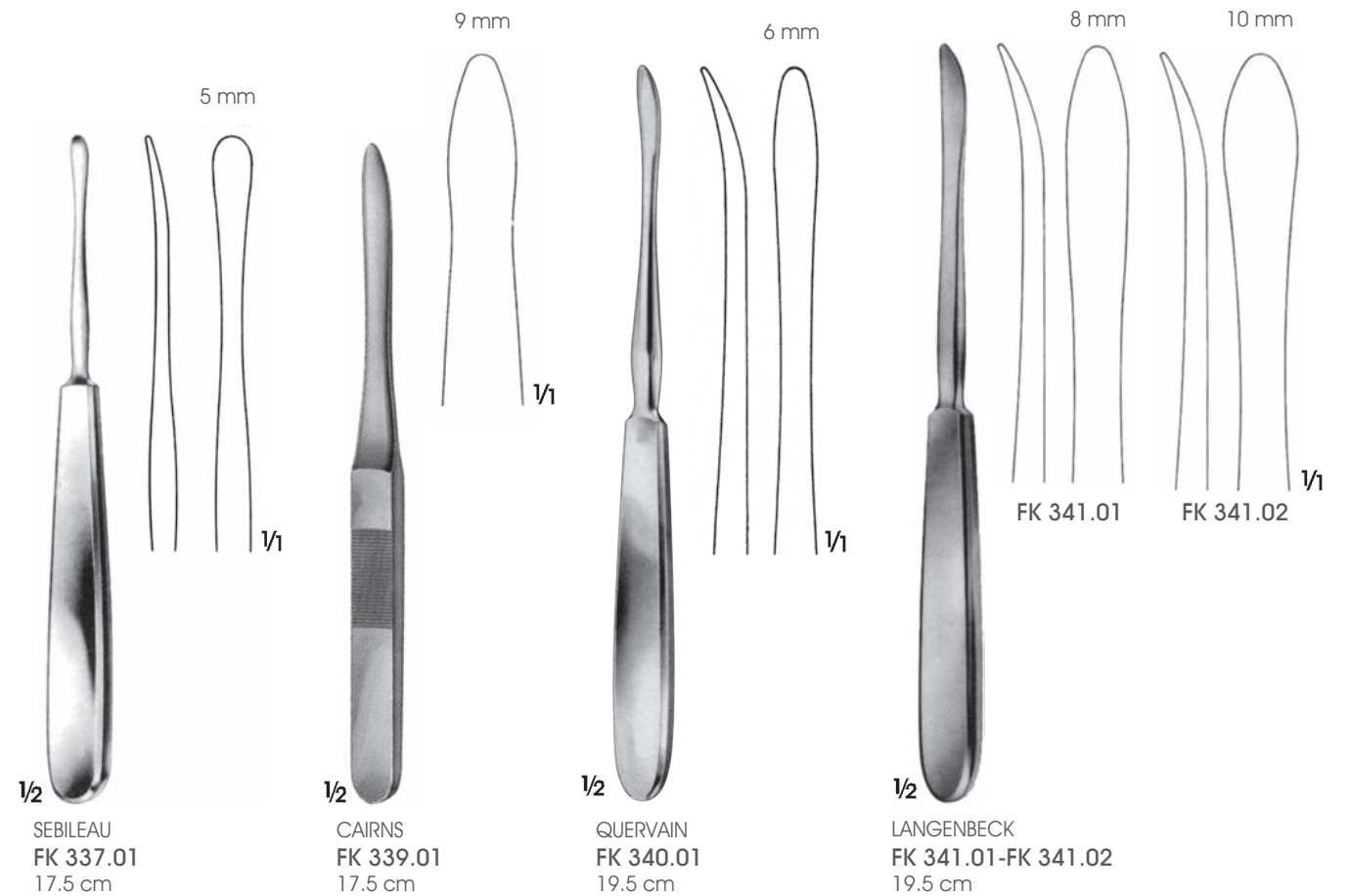
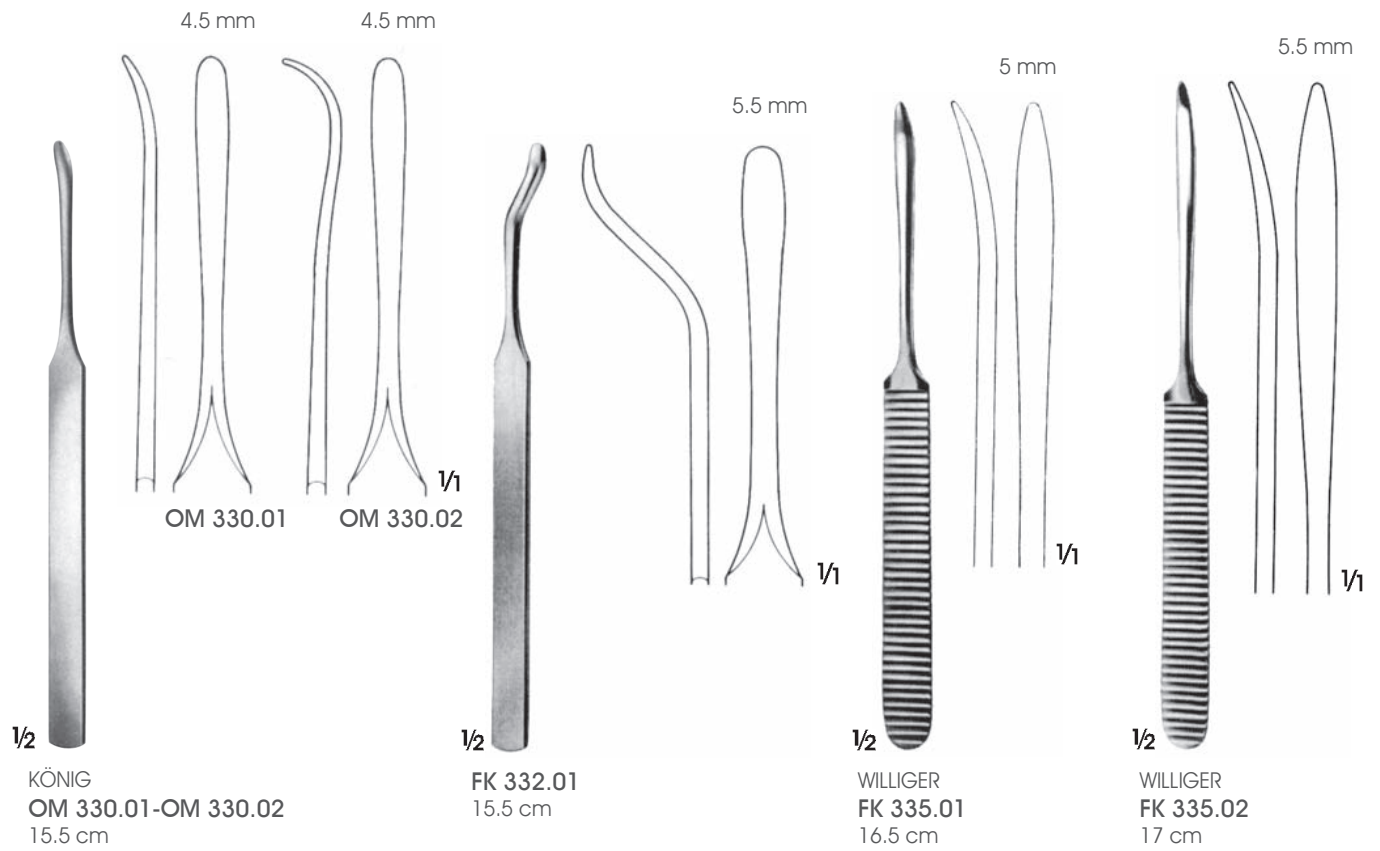



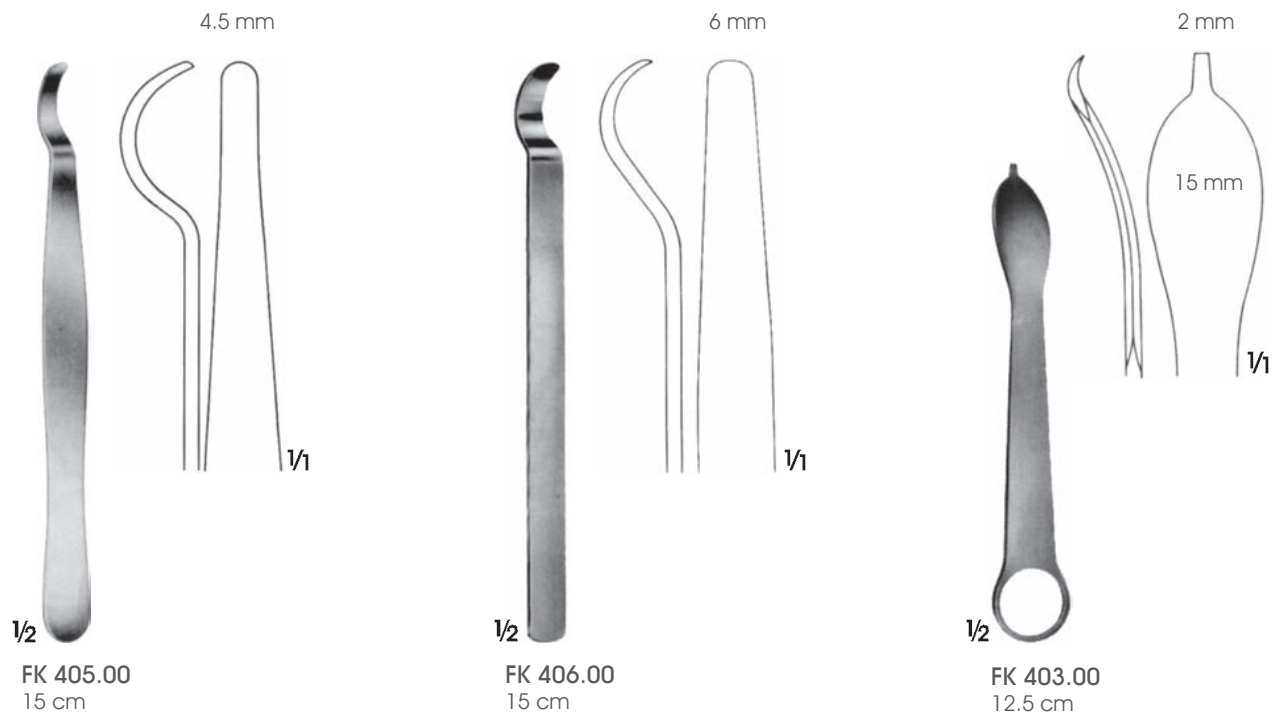
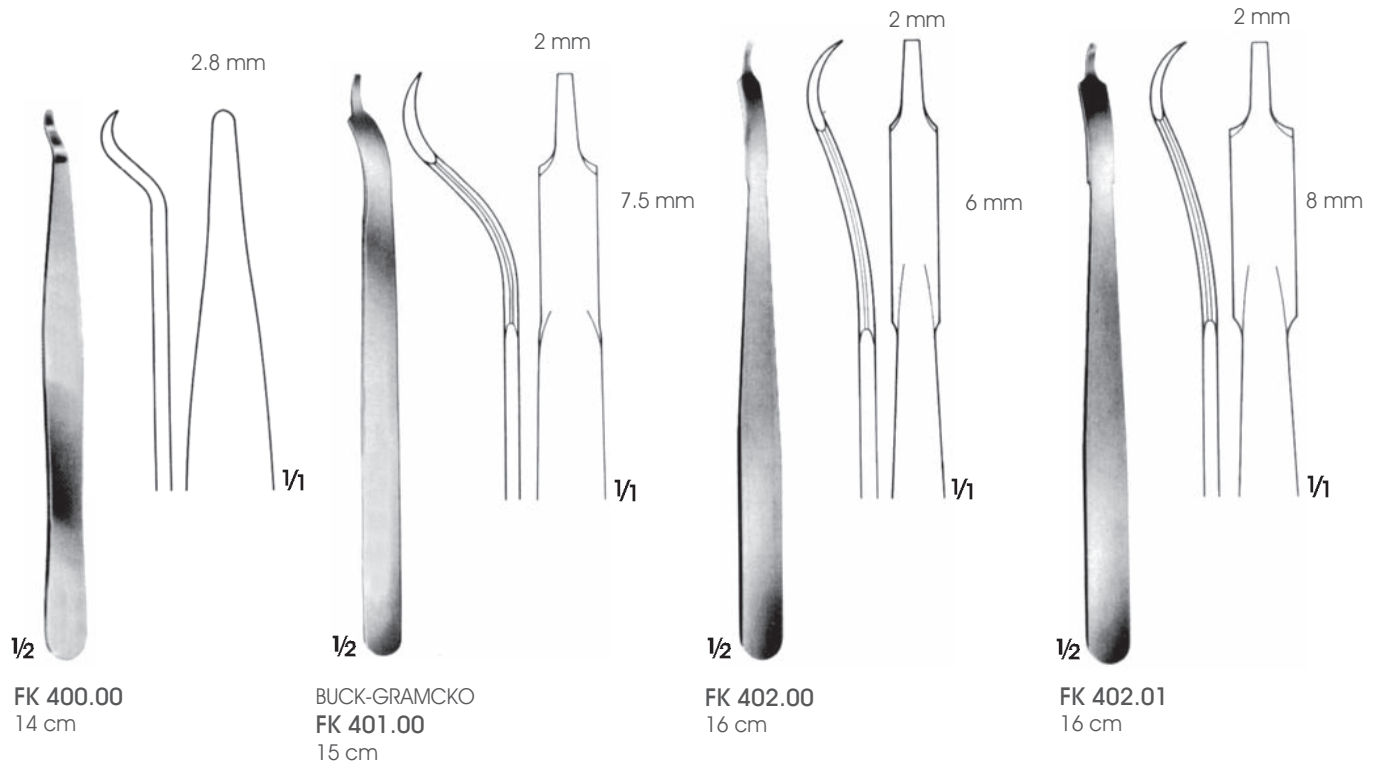

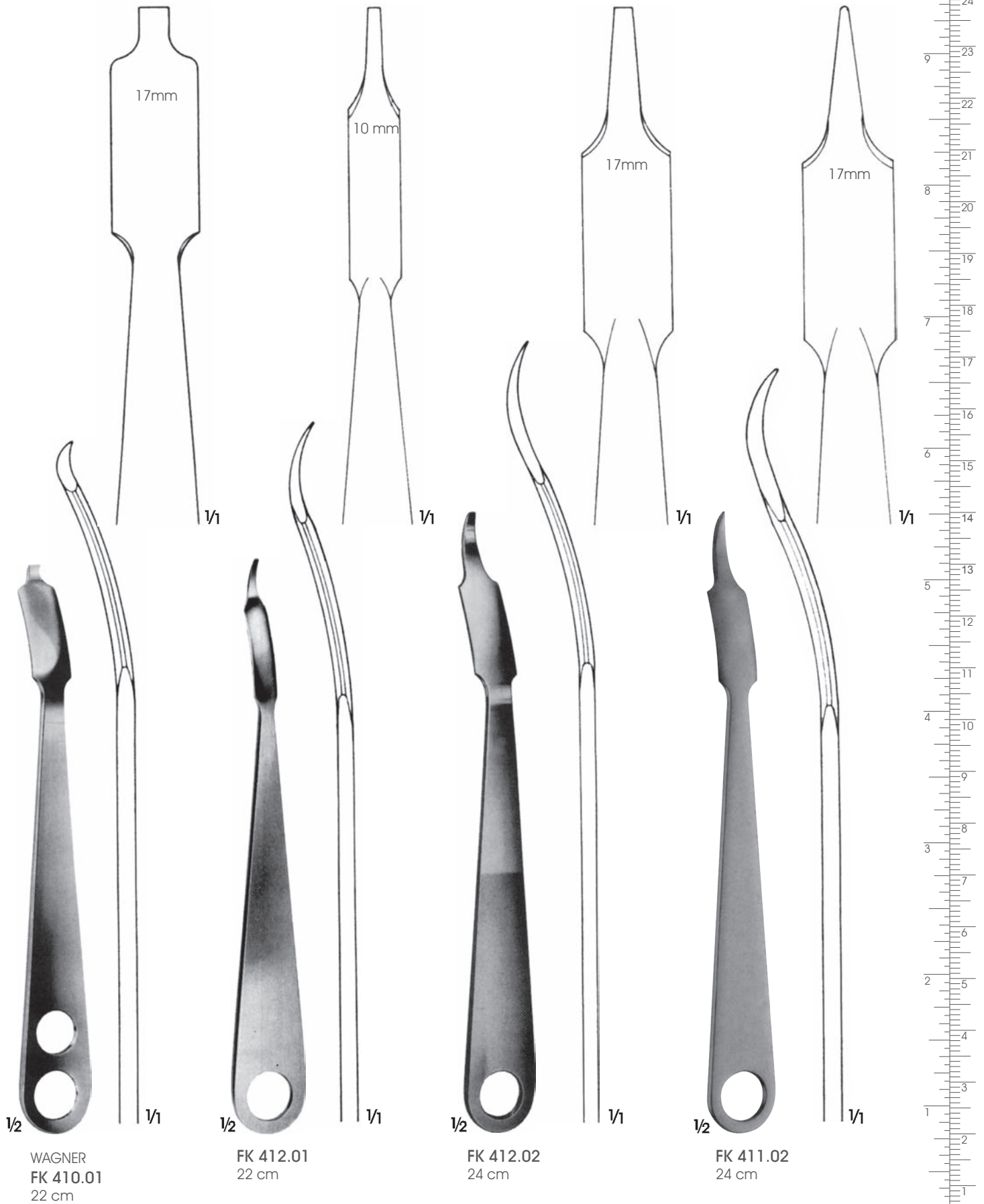

WAGNER
FK 410.01
22 cm

FK 412.01
22 cm

FK 412.02
24 cm

FK 411.02
24 cm



1/2

VATSON-JONES
FK 407.01
28 cm

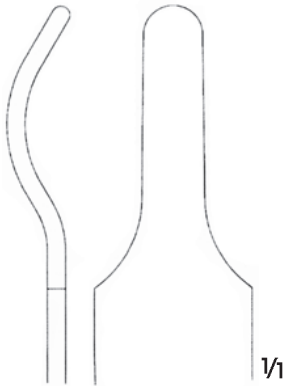

1/1



1/2

FK 408.01
22 cm

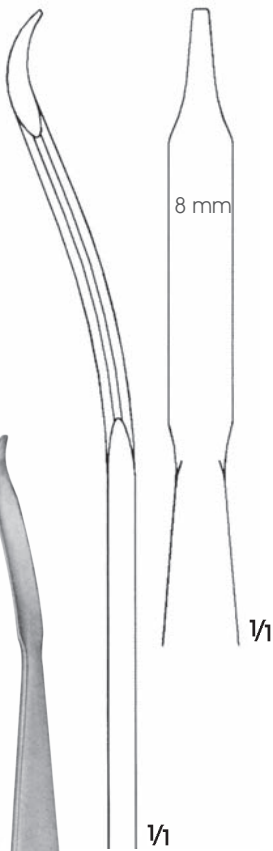

1/1

1/1



1/2

FK 426.01
25 cm

1/1

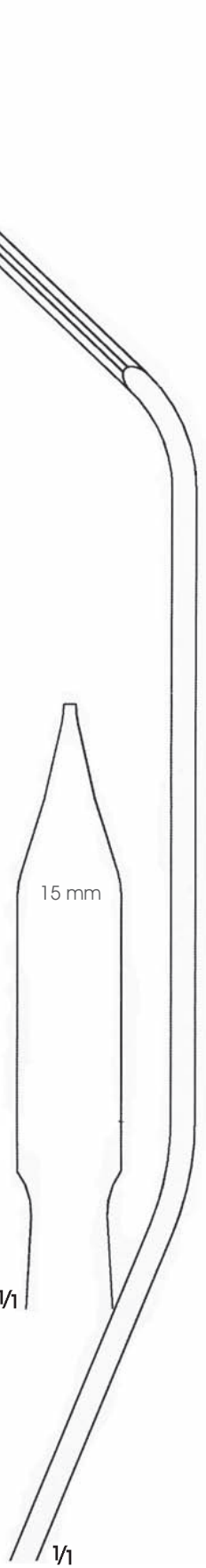

1/1



1/2

HOHMANN
FK 413.01
26 cm

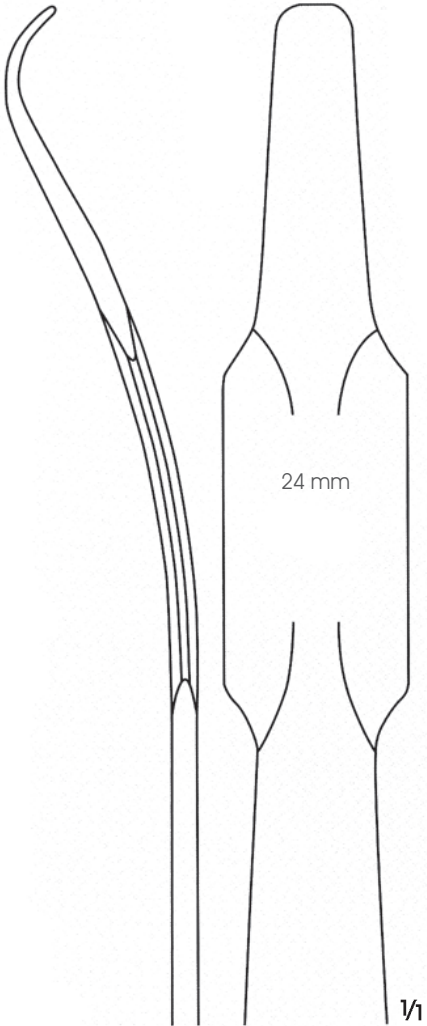

24 mm

1/1



1/2

HOHMANN
FK 413.03
28.5 cm

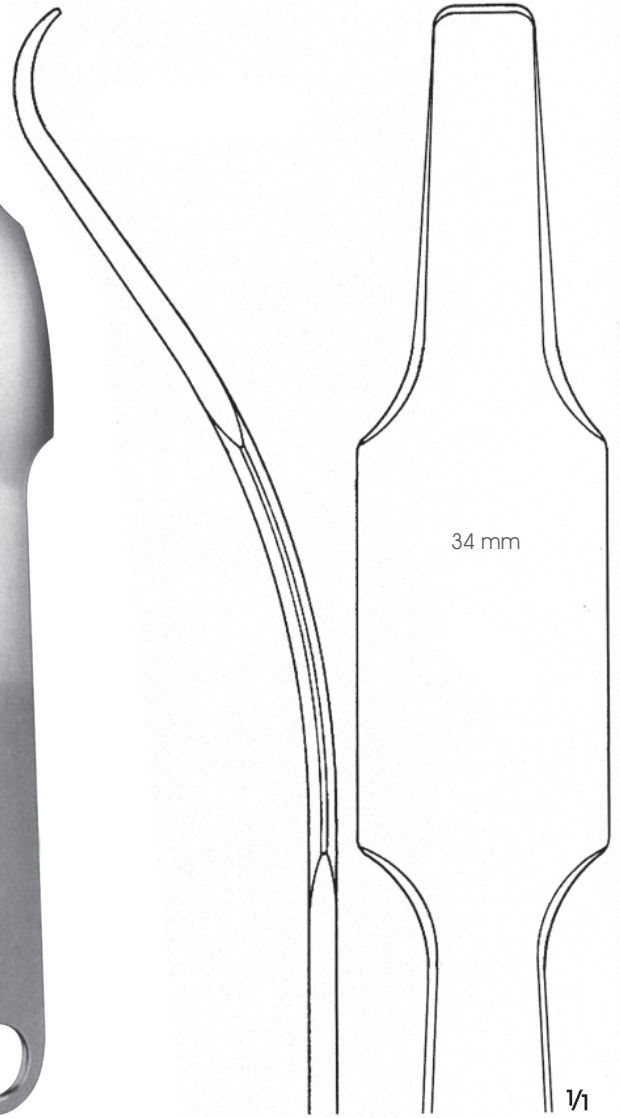

34 mm

1/1

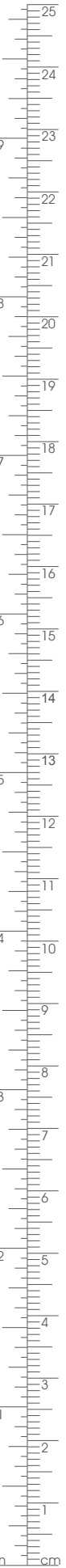

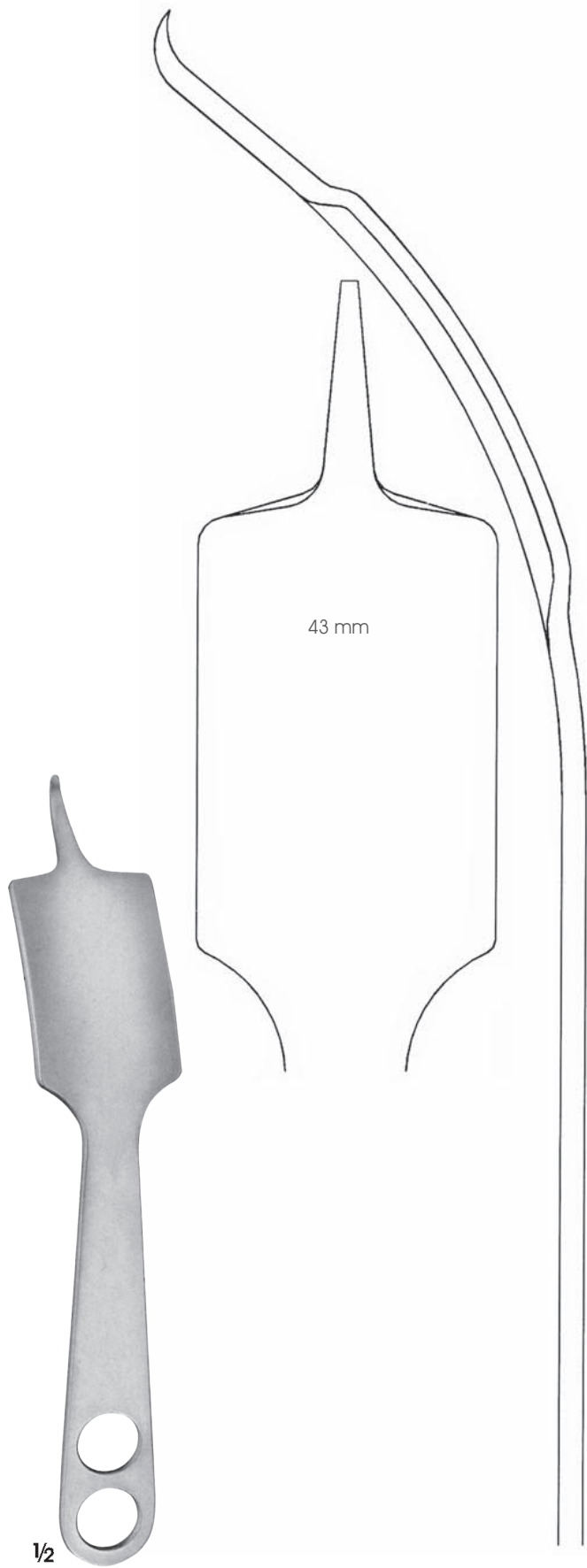

FK 414.01
23 cm

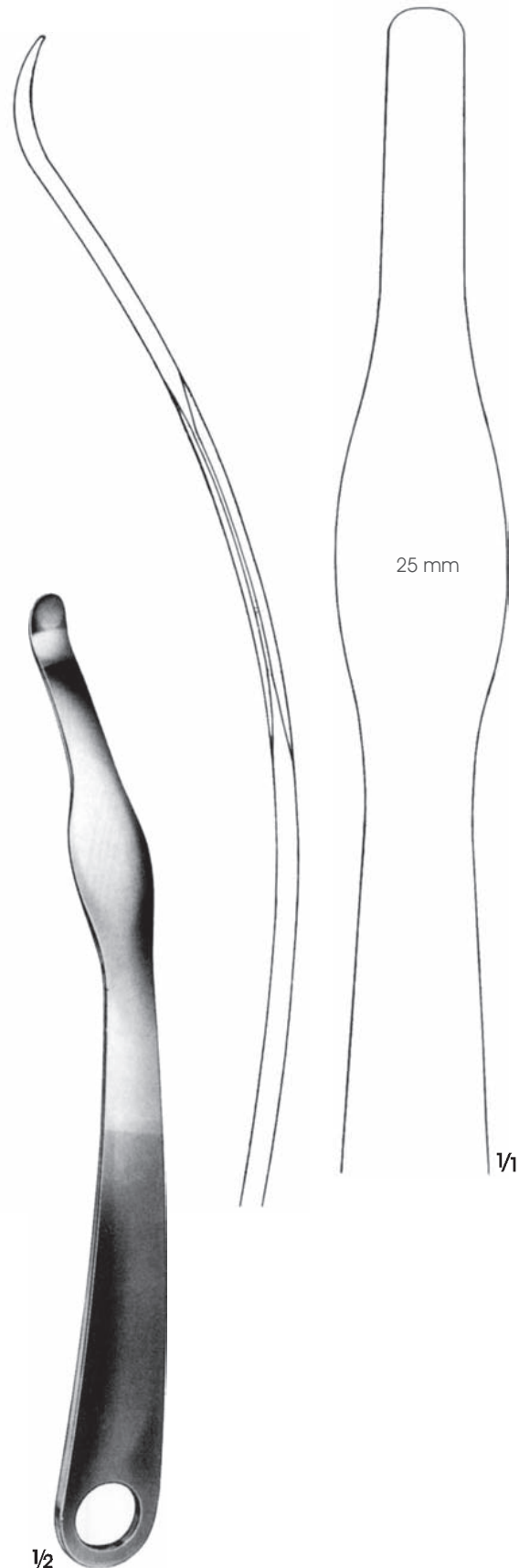

FK 418.02
26 cm

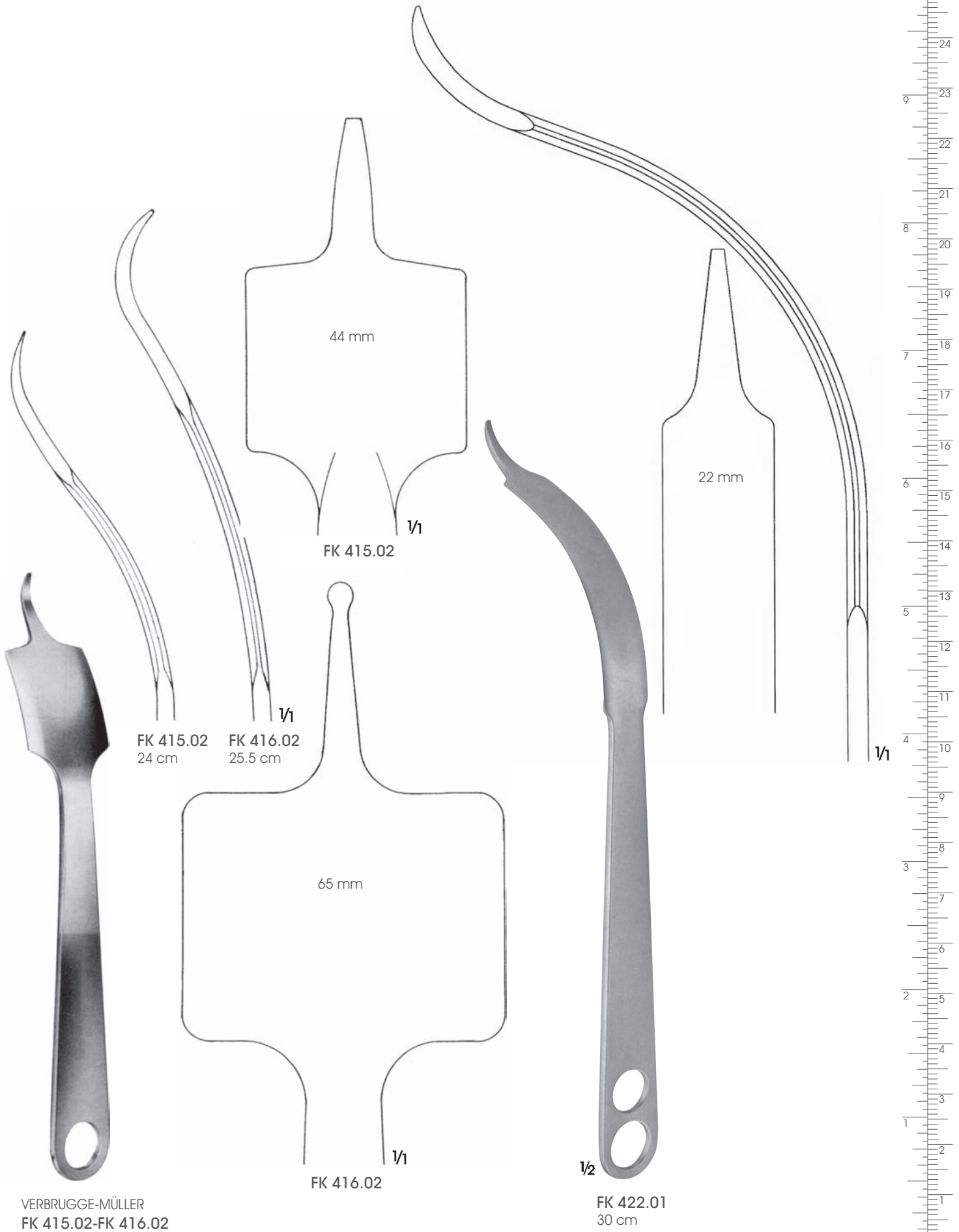

VERBRUGGE-MÜLLER
FK 415.02-FK 416.02

FK 422.01
30 cm

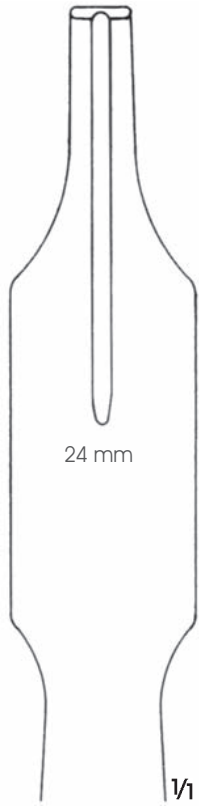

LANGE-HOHMANN
FK 420.02
25 cm

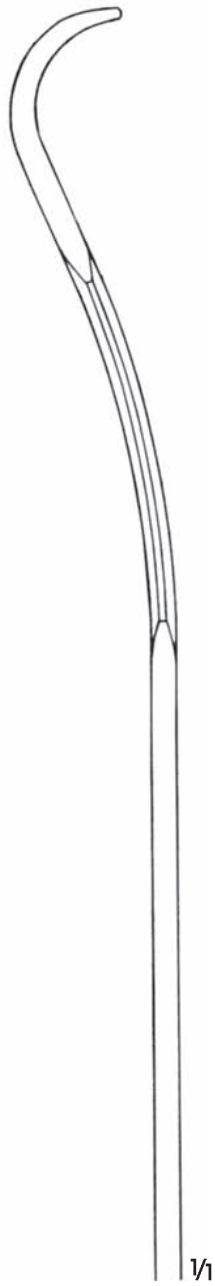

LANGE-HOHMANN
FK 421.02 26.5 cm
FK 421.03 28 cm

FK 421.02
30 mm
FK 421.03
33 mm

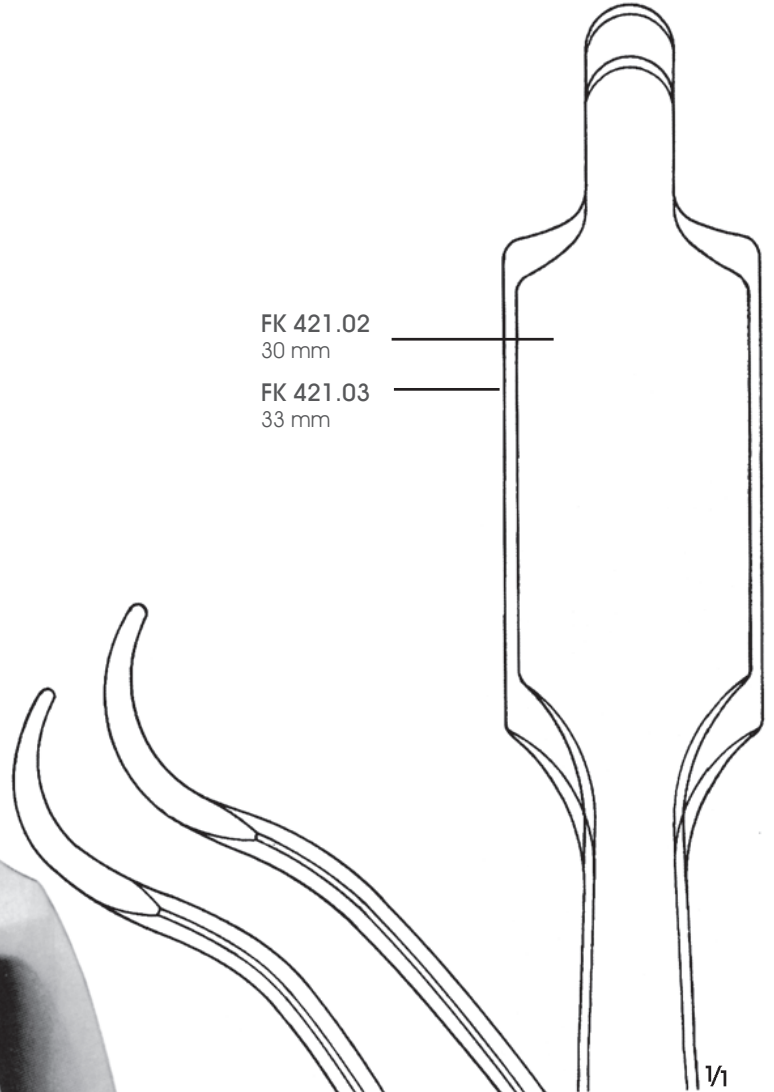

FK 421.02

FK 421.03

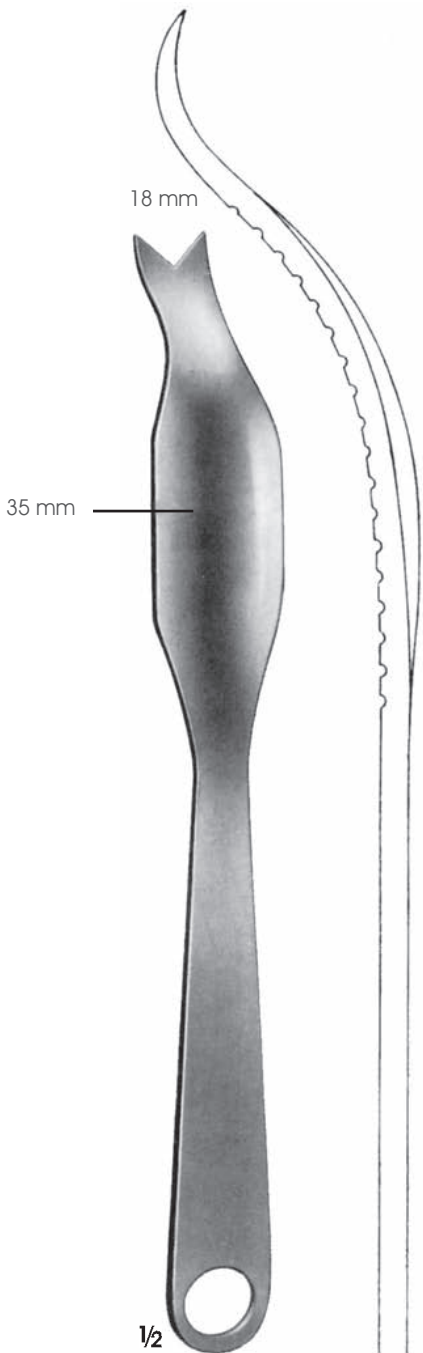

1/2

SCHUMACHER
FK 423.02
29 cm

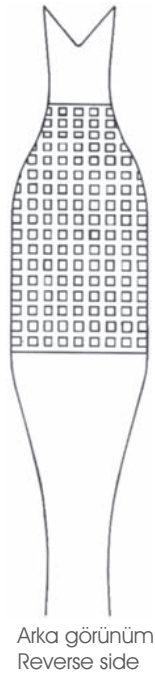

Arka görünüm
Reverse side



1/2

1/1

SCHUMACHER-WAGNER
FK 424.02
35.5 cm

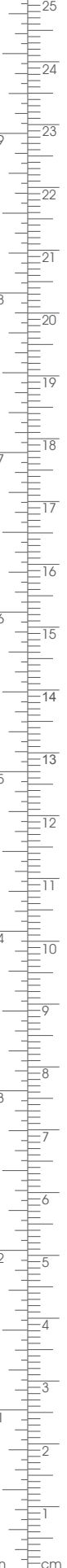

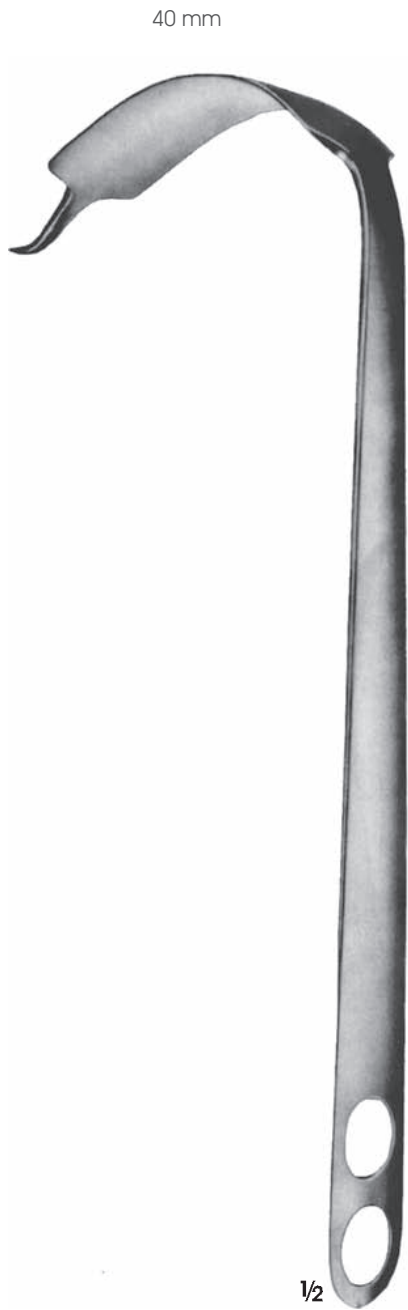

FK 427.01
32 cm

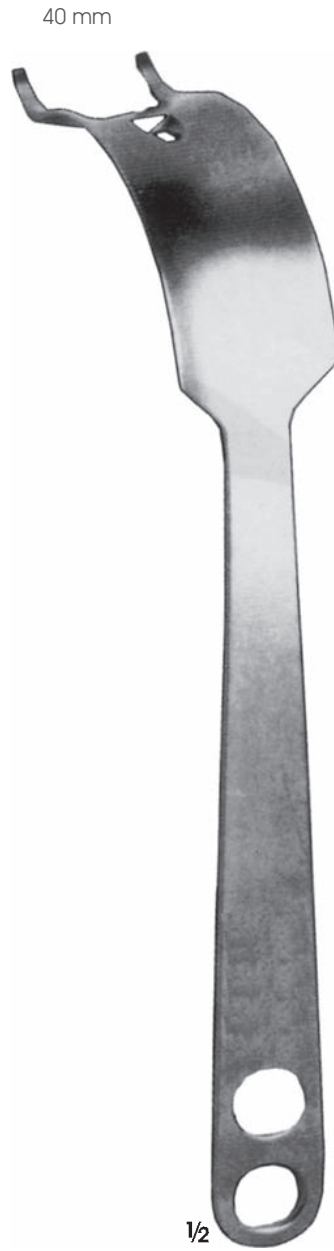

FK 429.02
32 cm



FK 434.01
Femur ekartörü
Femoral retractor
38 cm

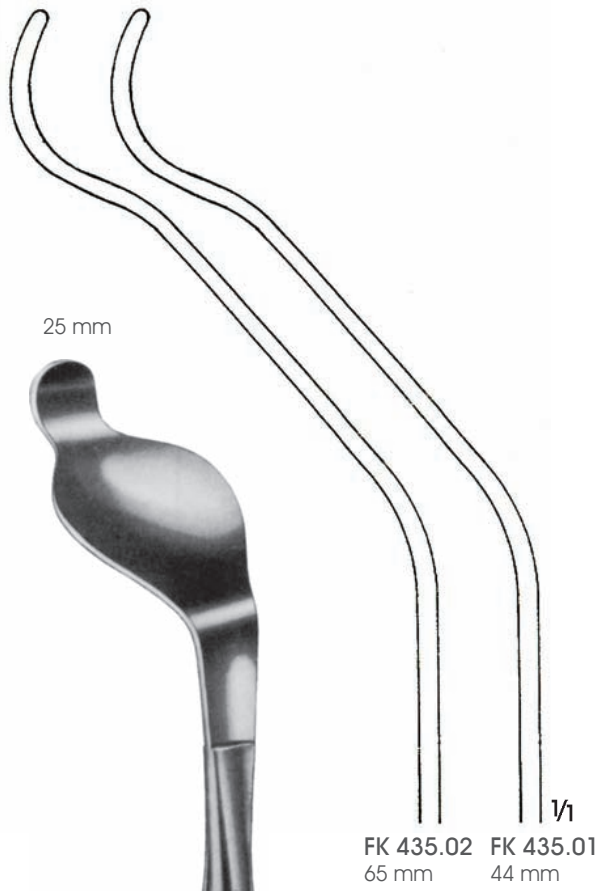

1/2
BENNETT
FK 435.01 25 mm-44 mm
FK 435.02 25 mm-65 mm
23.5 cm

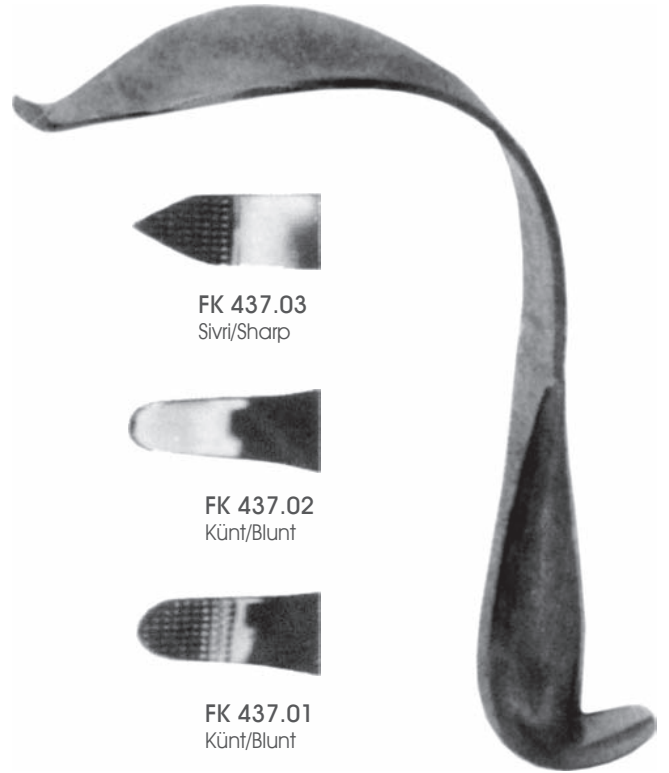

COBRA
FK 437.01-FK 437.03
28 cm





1/2
HOHMANN-ALDINGER
FK 425.02
27 cm

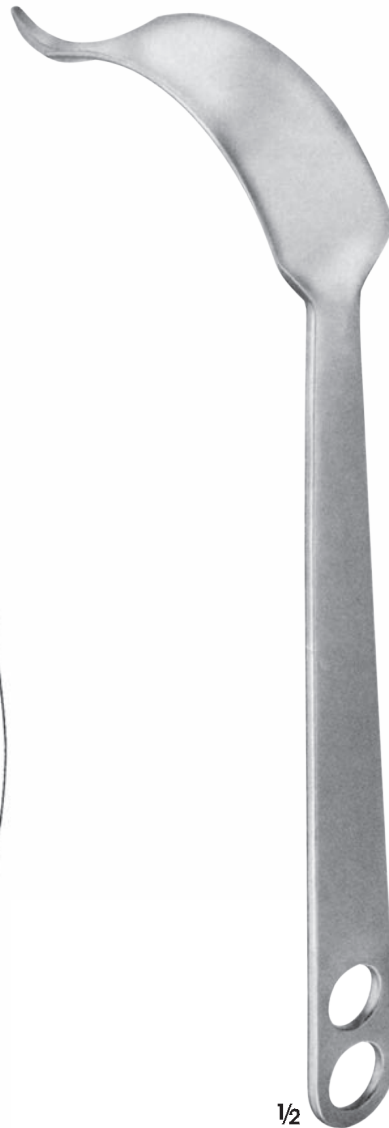

1/2
FK 428.01
29 cm

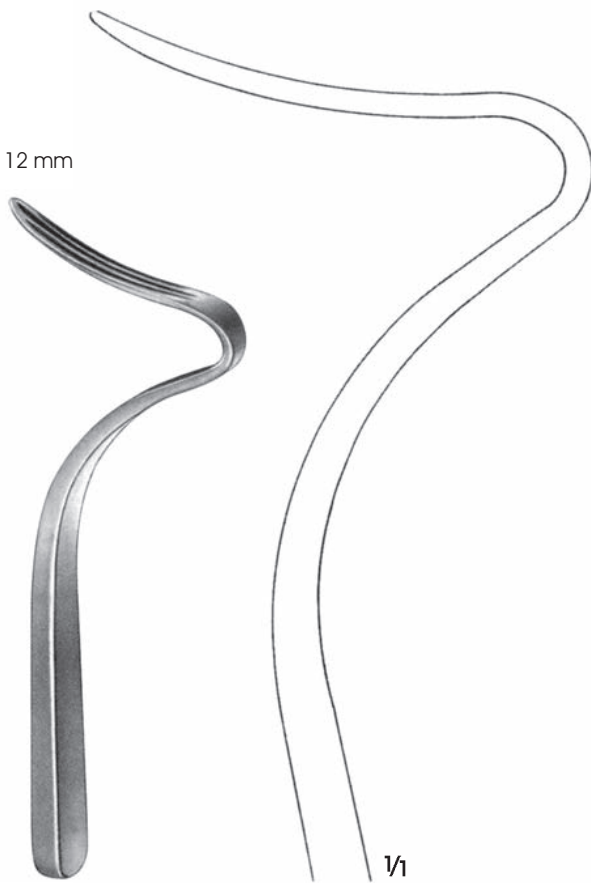

TAGER
FK 440.00
Mafsal elevatör
Bone lever for angle joint operations
17.5 cm

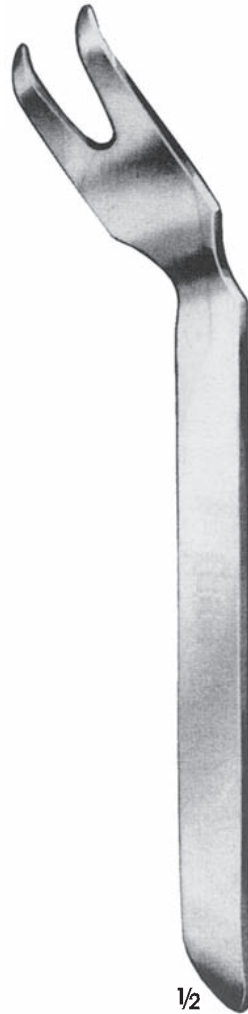

BLOUNT
FK 431.02
27 cm

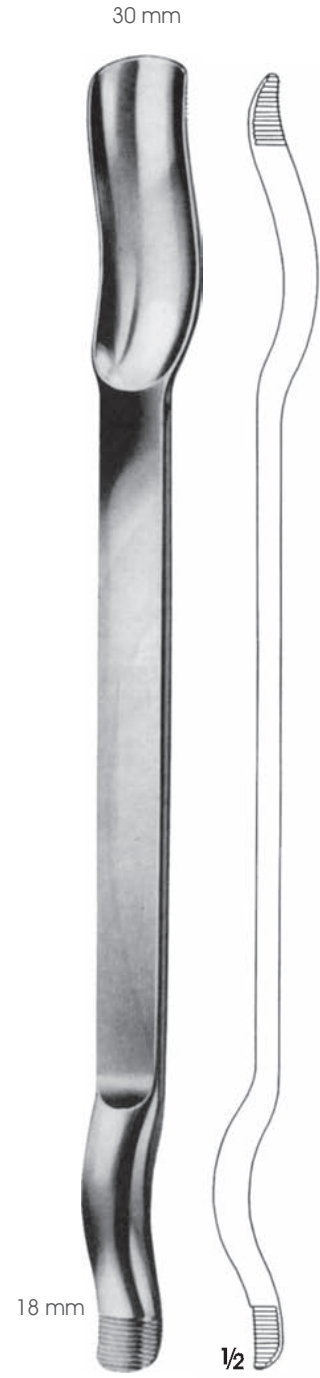

MURPHY-LANE
FK 442.02
Luksasyon elevatörü
Luxation lever
33 cm



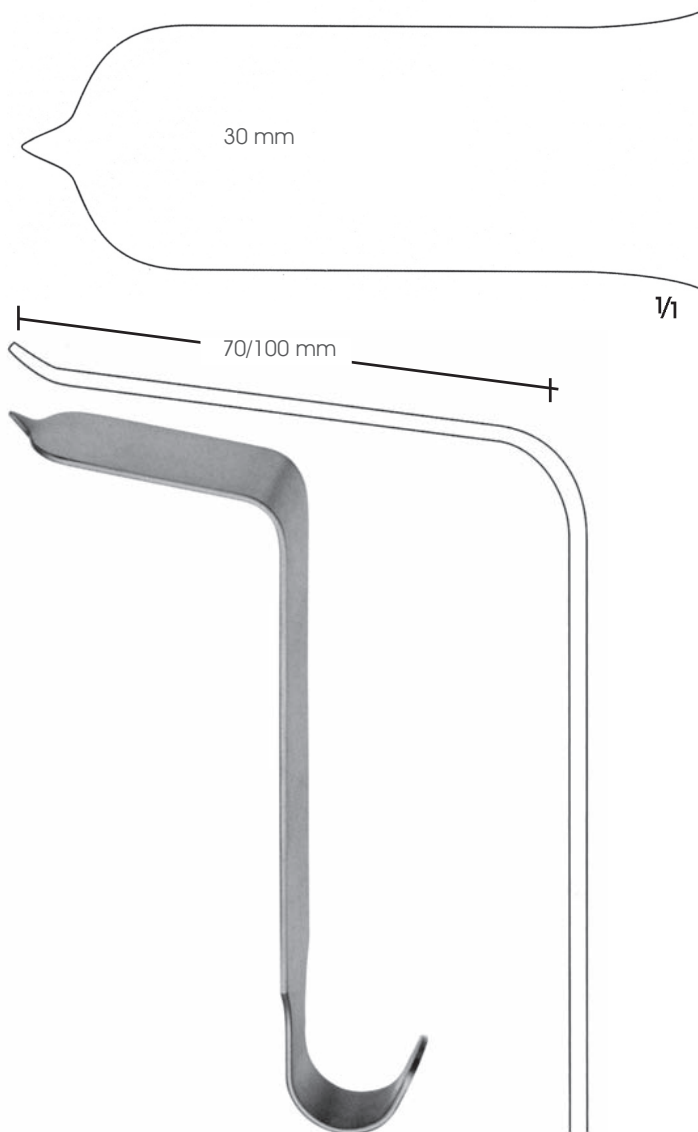

TAYLOR
BT 482.00 30 x 70 mm
18.5 cm
BT 482.01 30 x 100
mm 20 cm



HIBBS
BT 335.00-BT 335.02
23.5 cm

90°

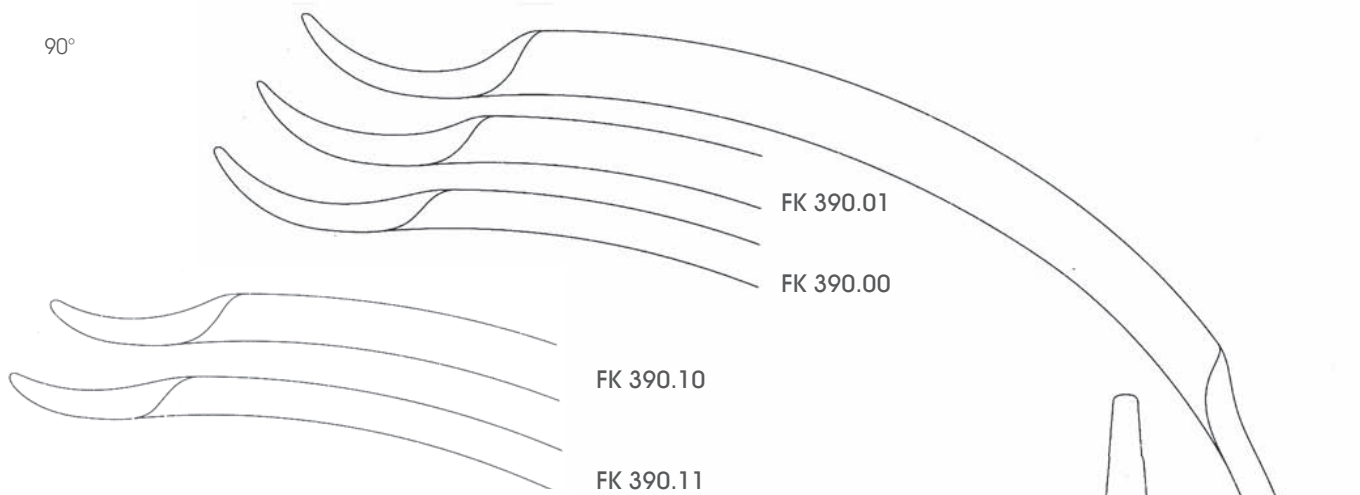

FK 390.10-FK 390.11
Kısa tip/Short tip
24 cm



FK 390.00-FK 390.02
Sivri tip/Sharp tip
24 cm

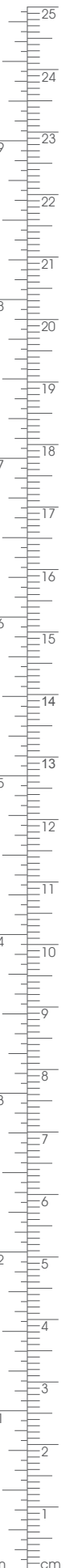

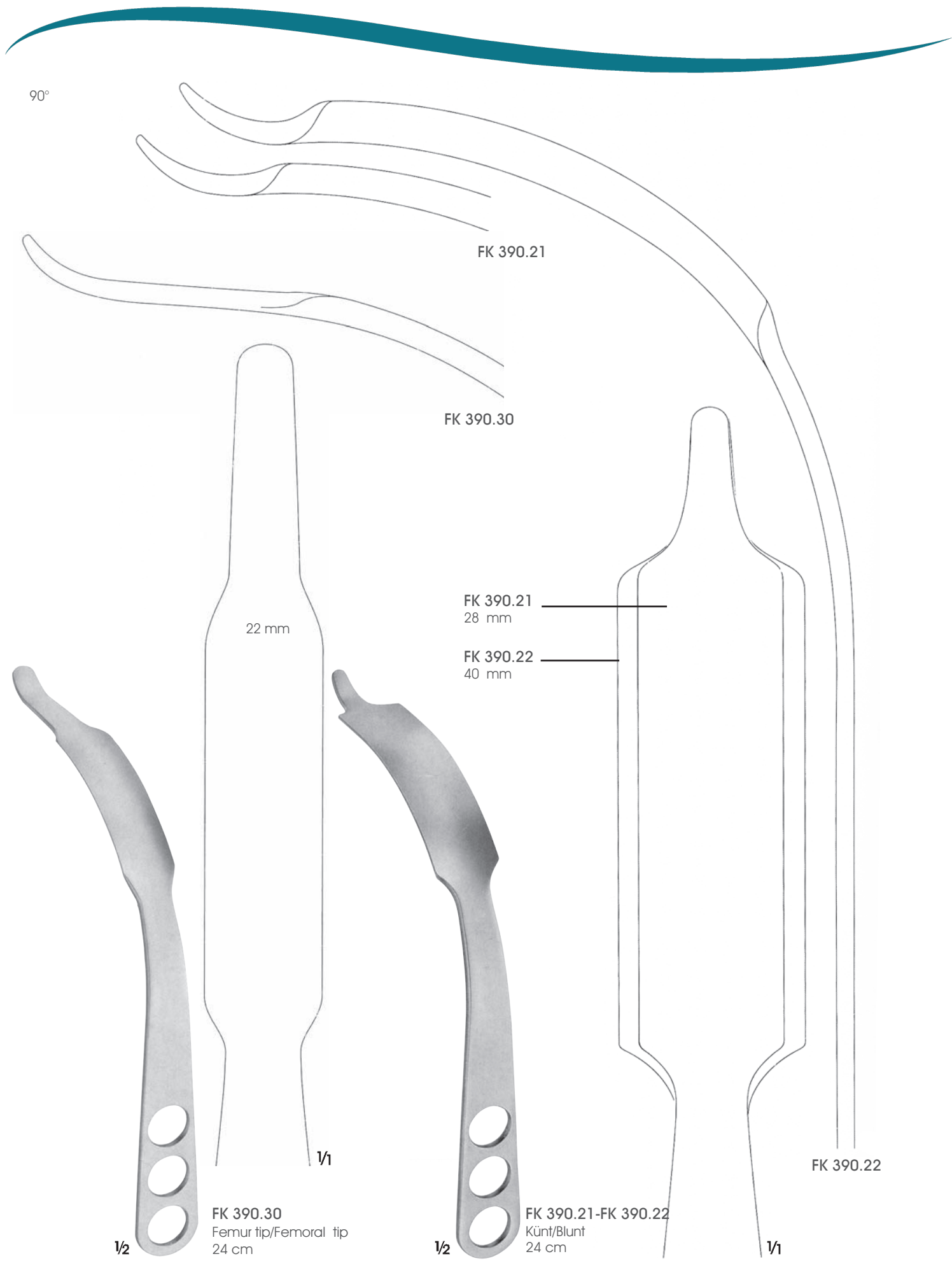

45°

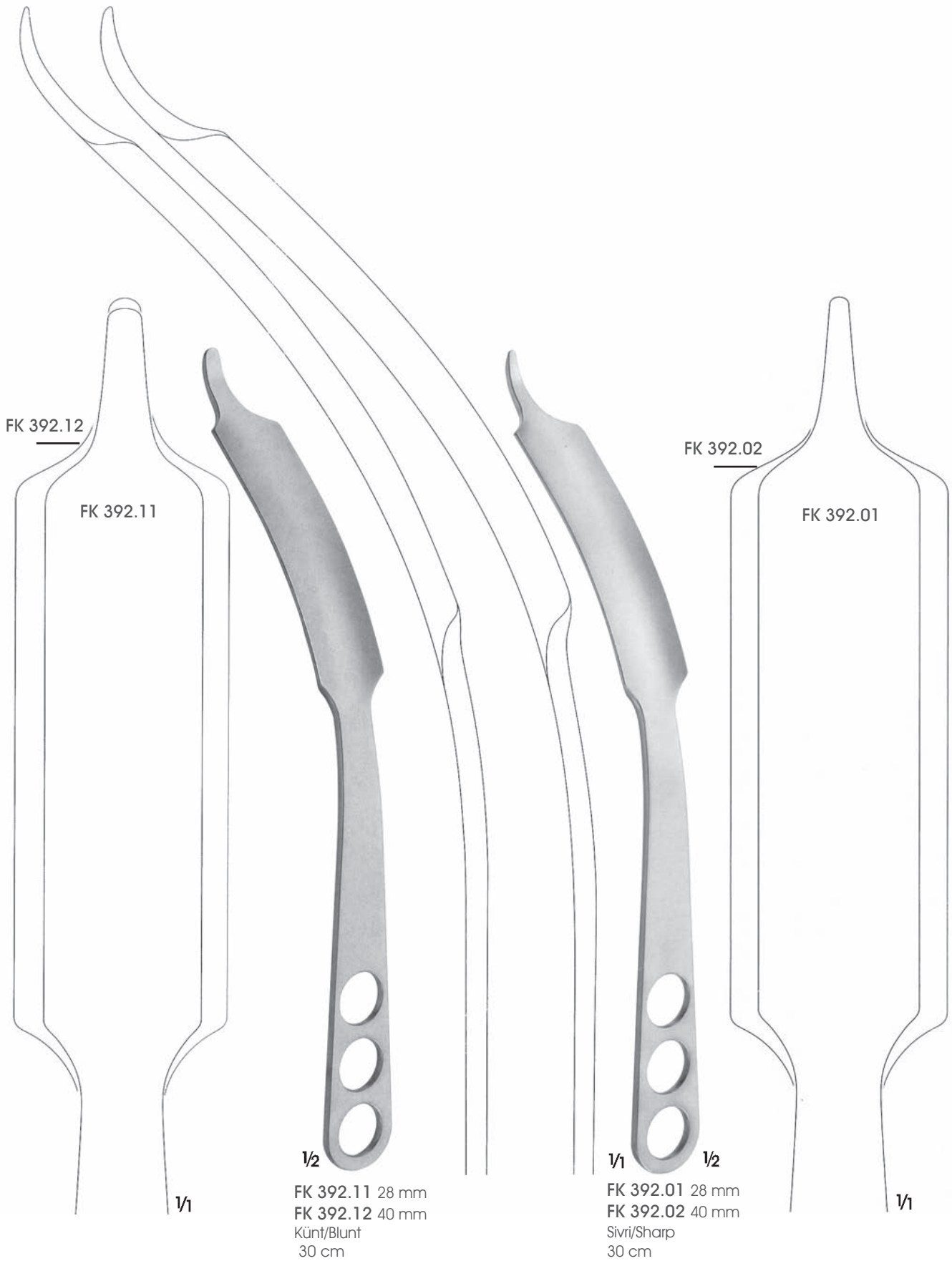

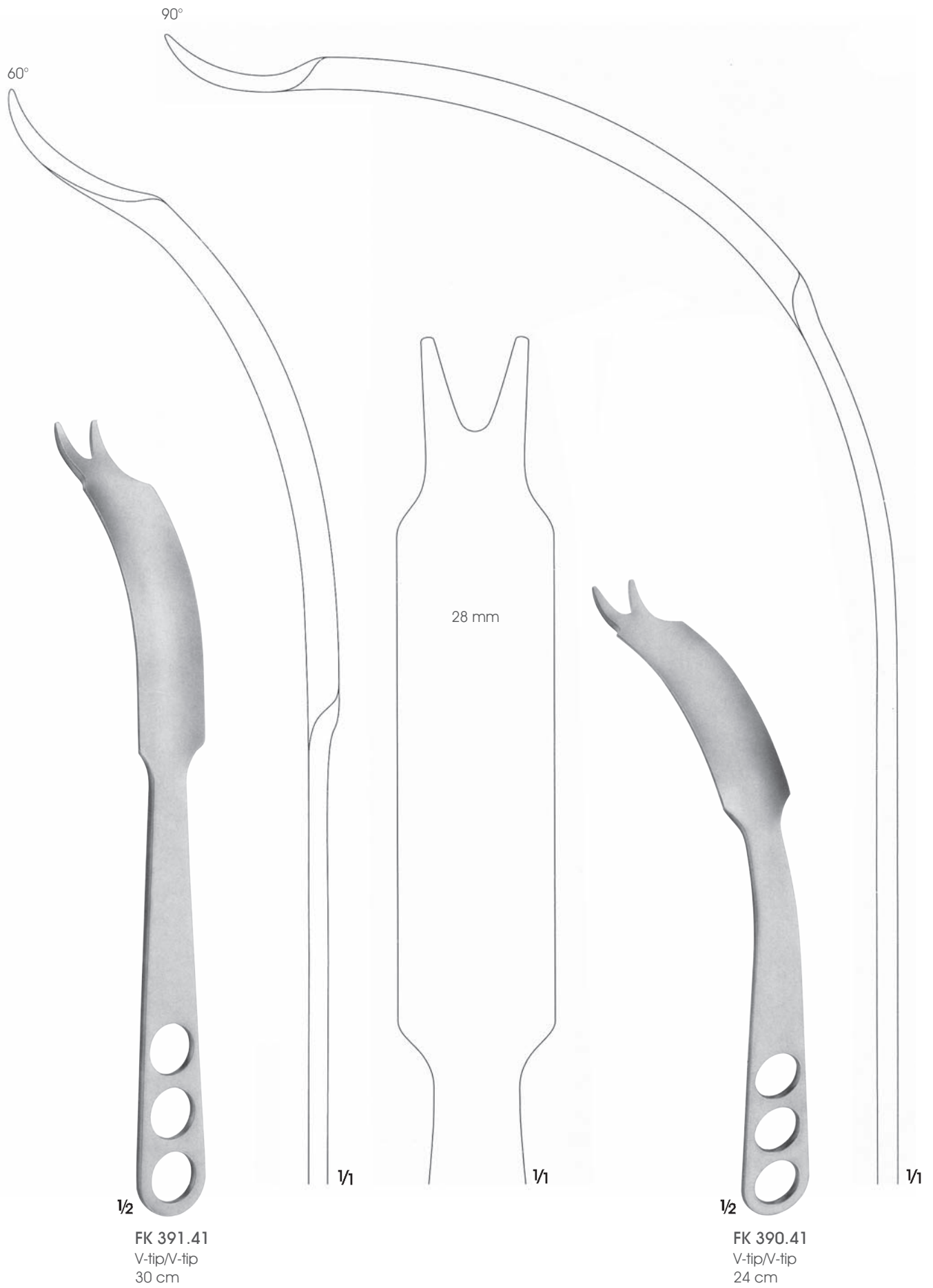

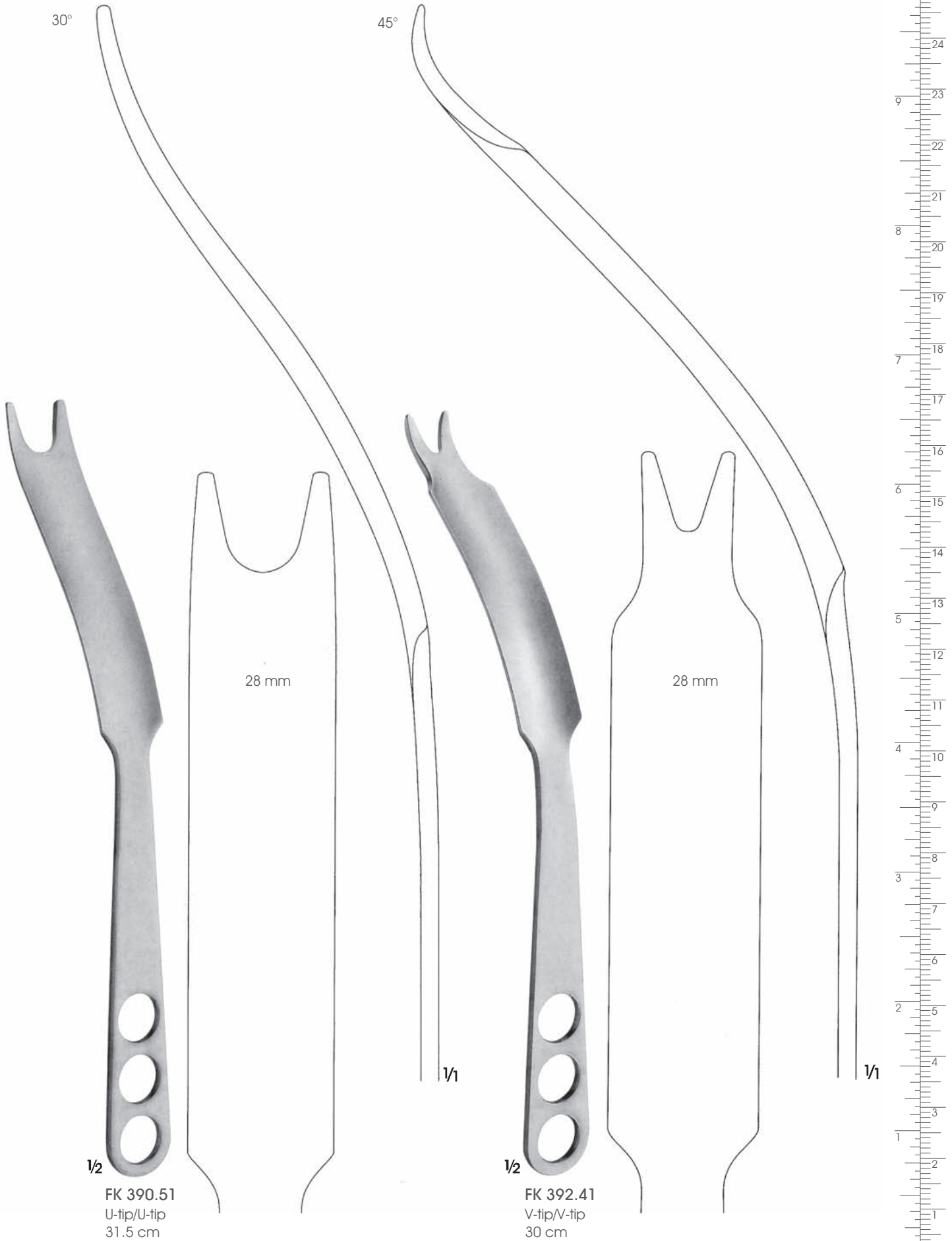

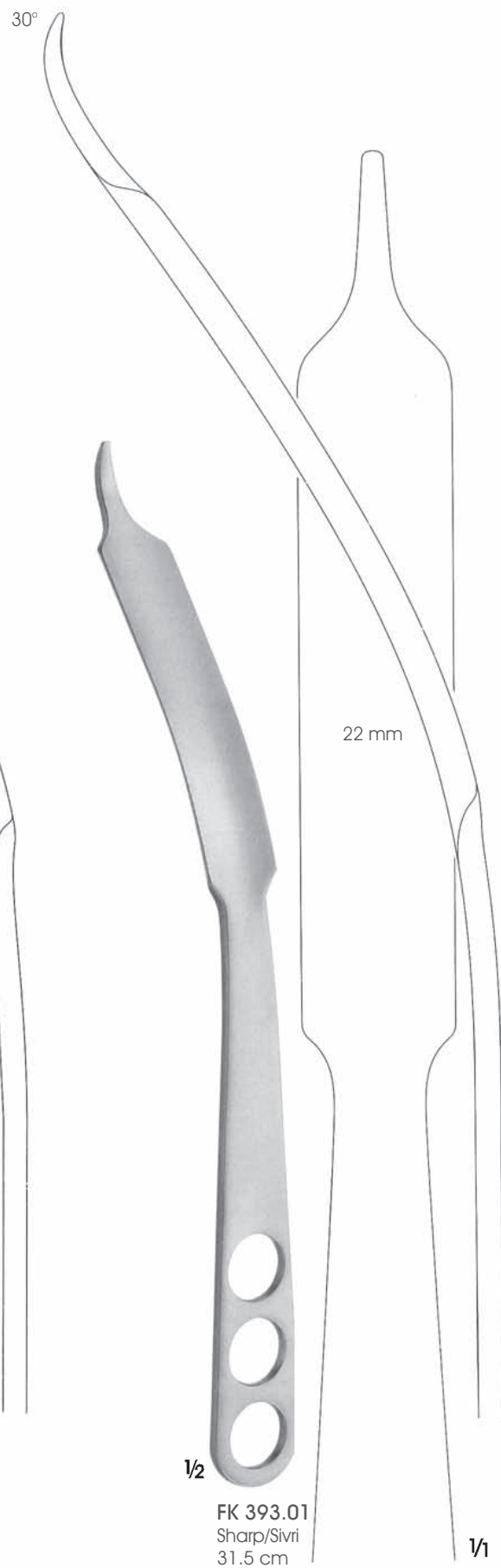
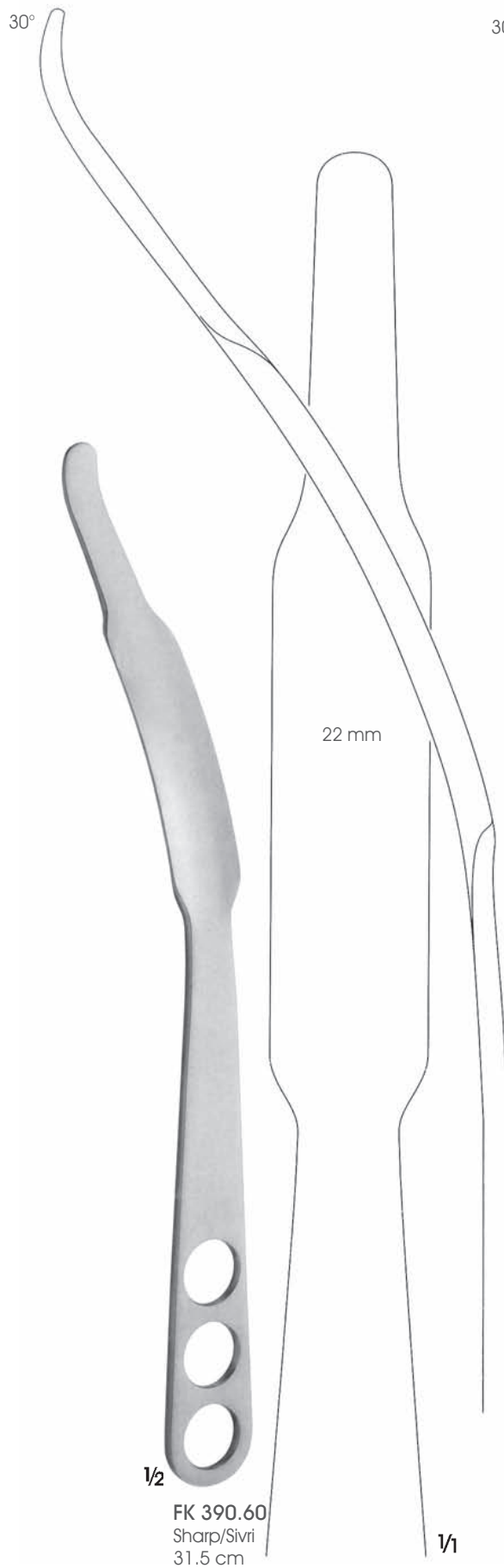

30°

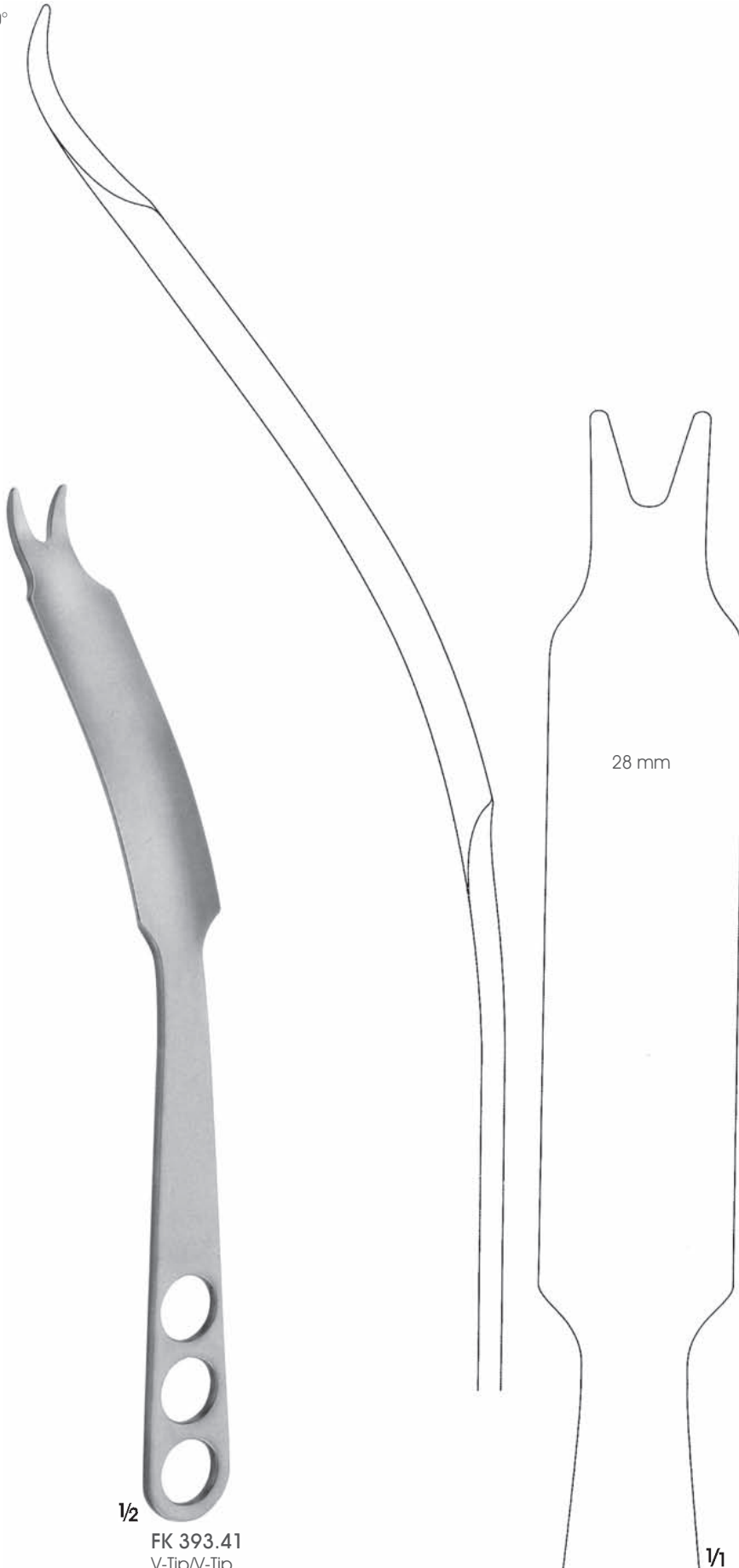

1/2

FK 393.41
V-Tip/V-Tip
31.5 cm

28 mm

1/1

FK 399.01
Kavrama silikonu
Hand grip

FK 399.02
Kavrama silikonu
Hand grip

FK 399.03
Kavrama silikonu
Hand grip

FK 399.04
Kavrama silikonu
Hand grip



in cm

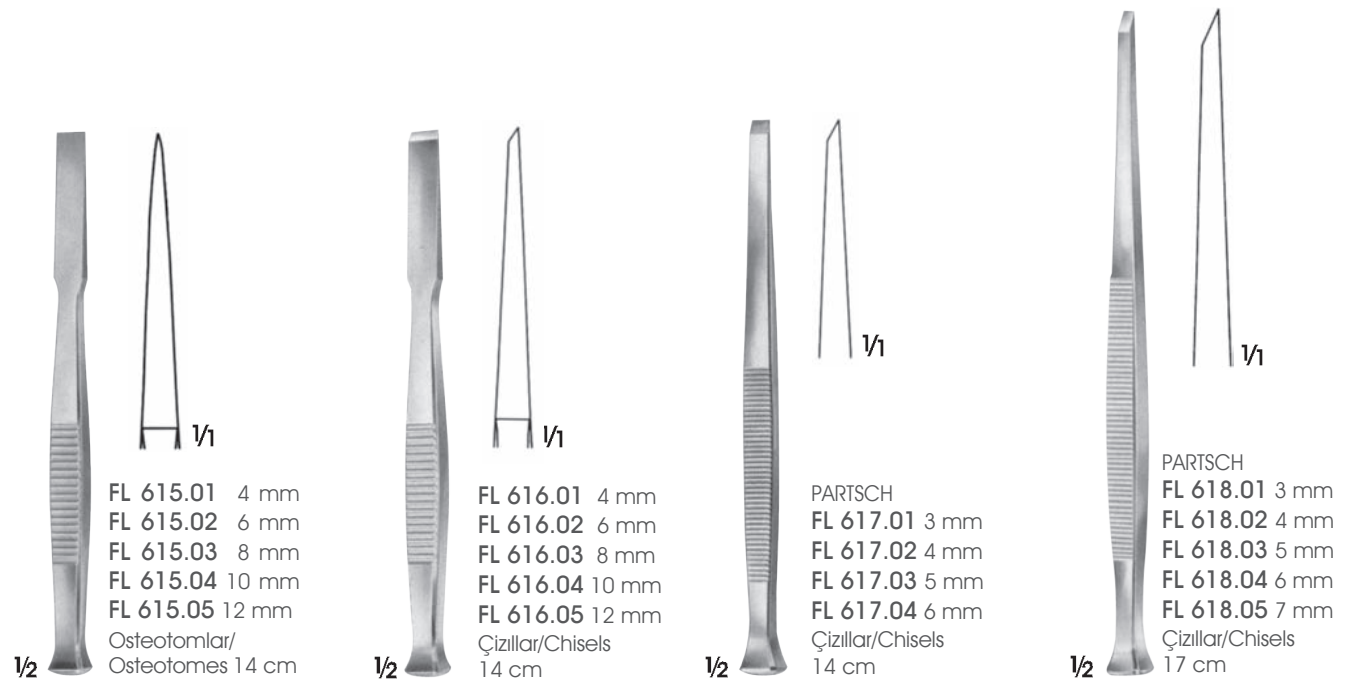
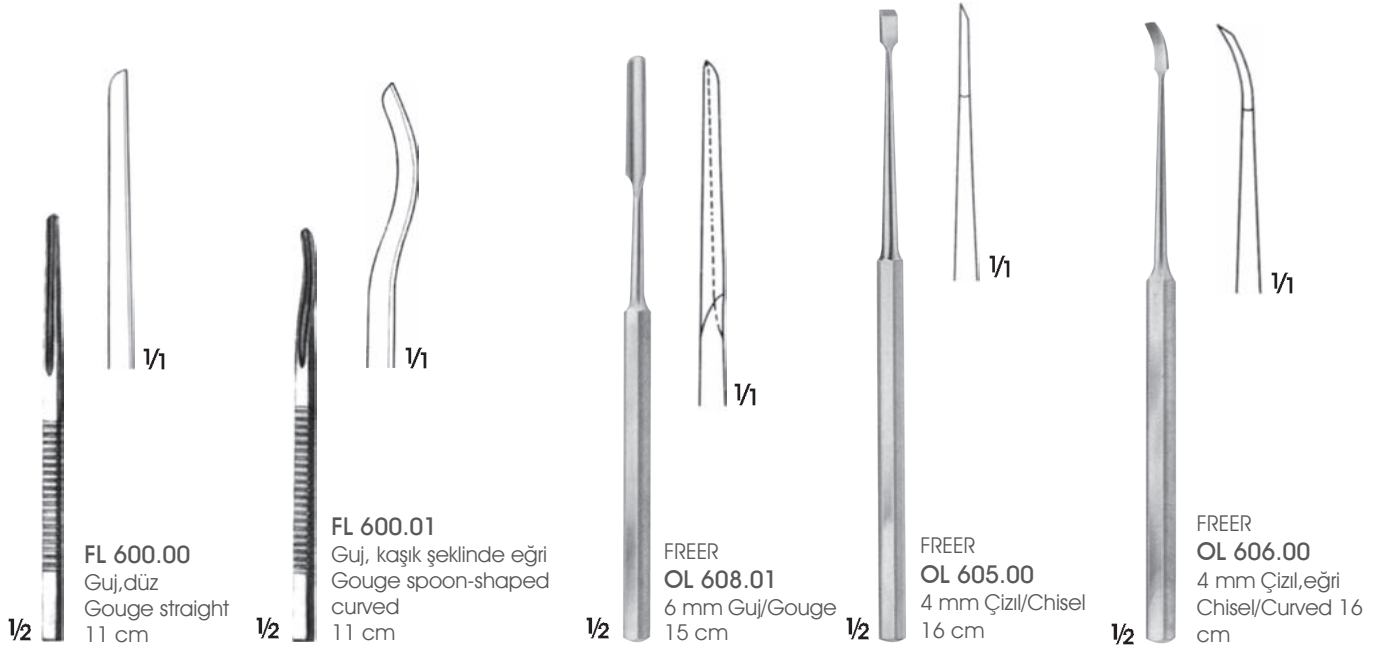

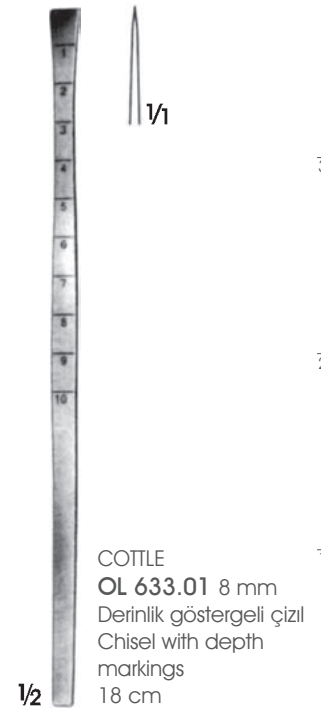
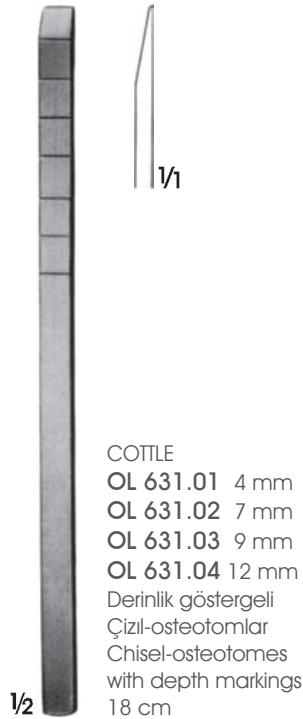
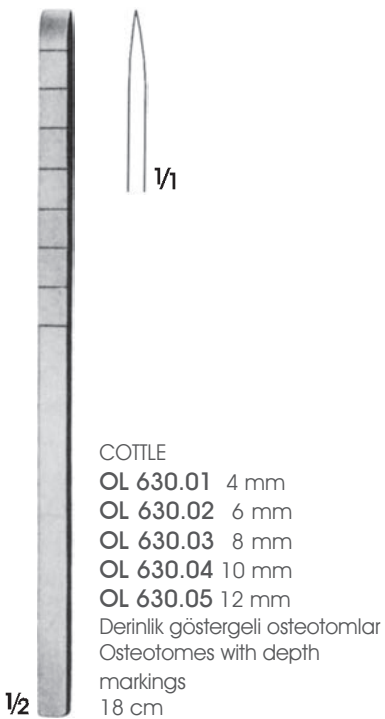
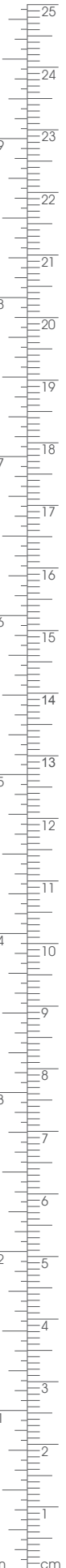
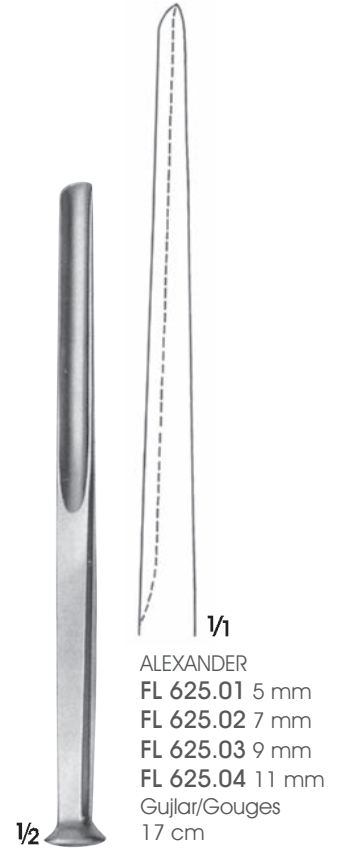
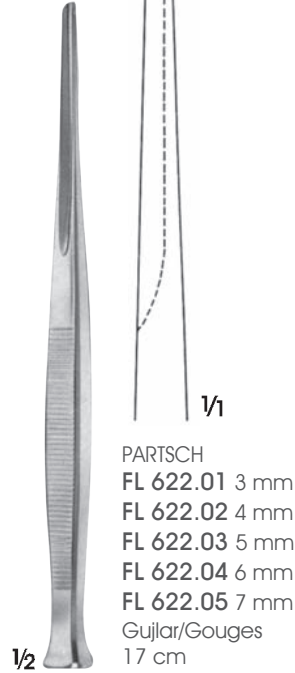
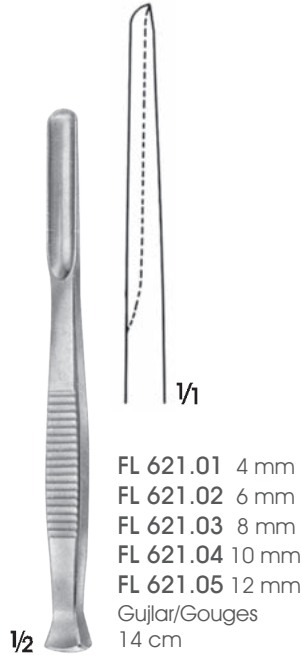
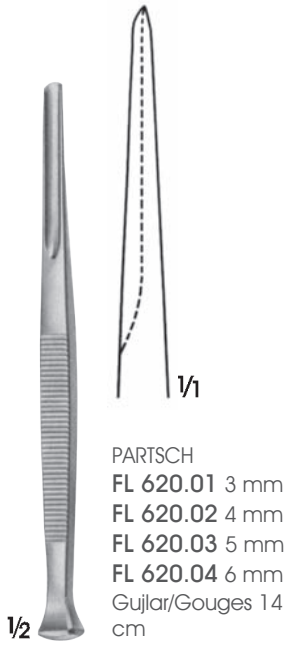

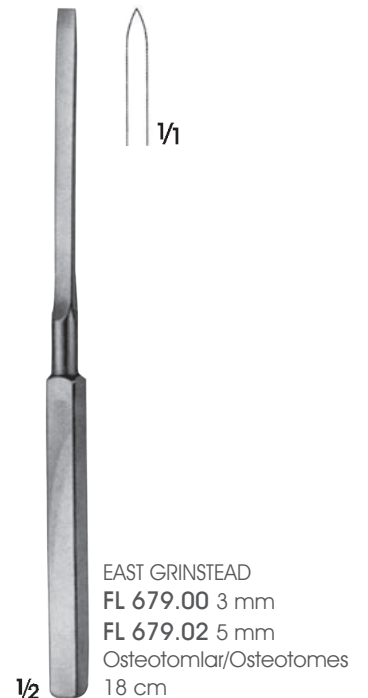
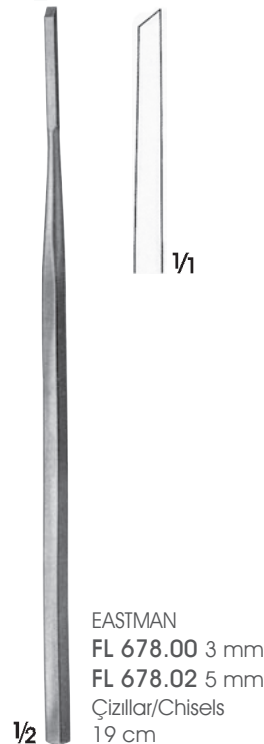
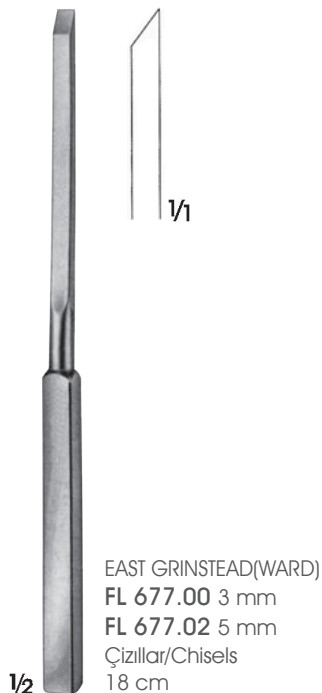
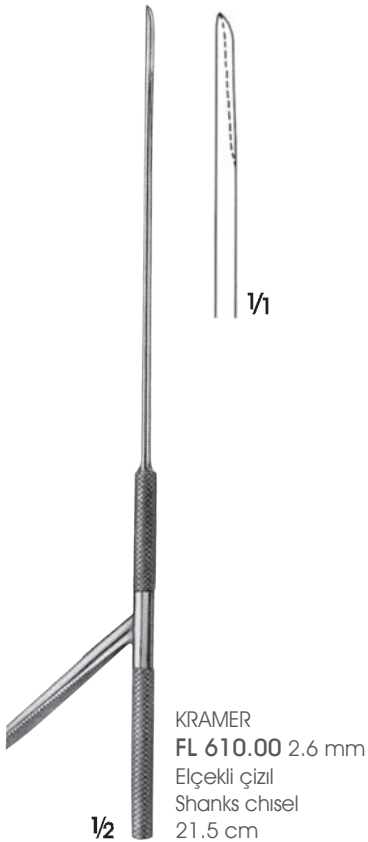
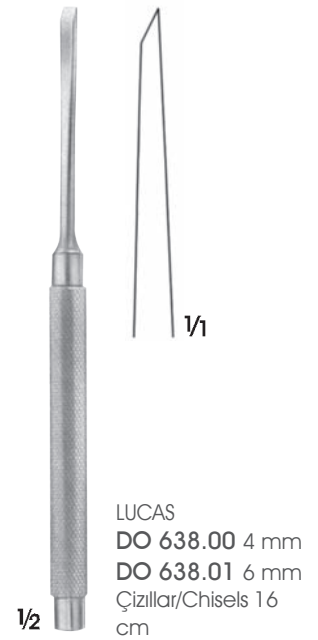
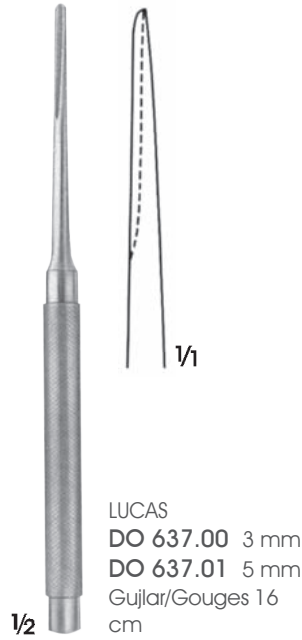
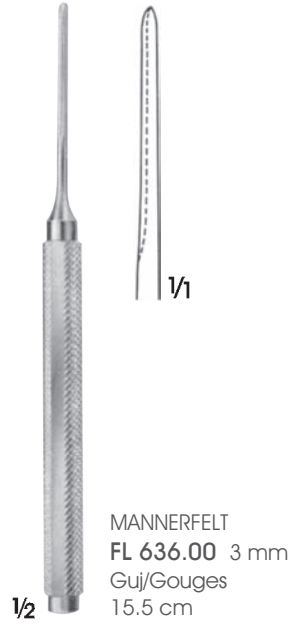
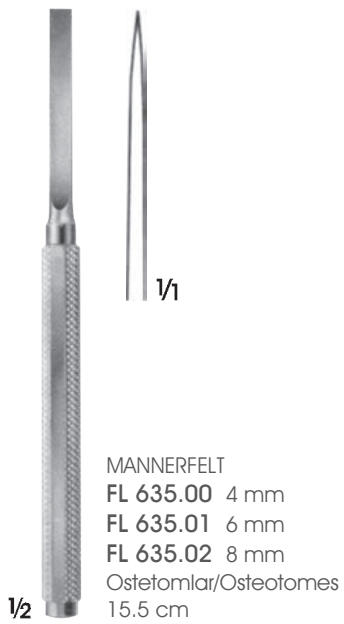

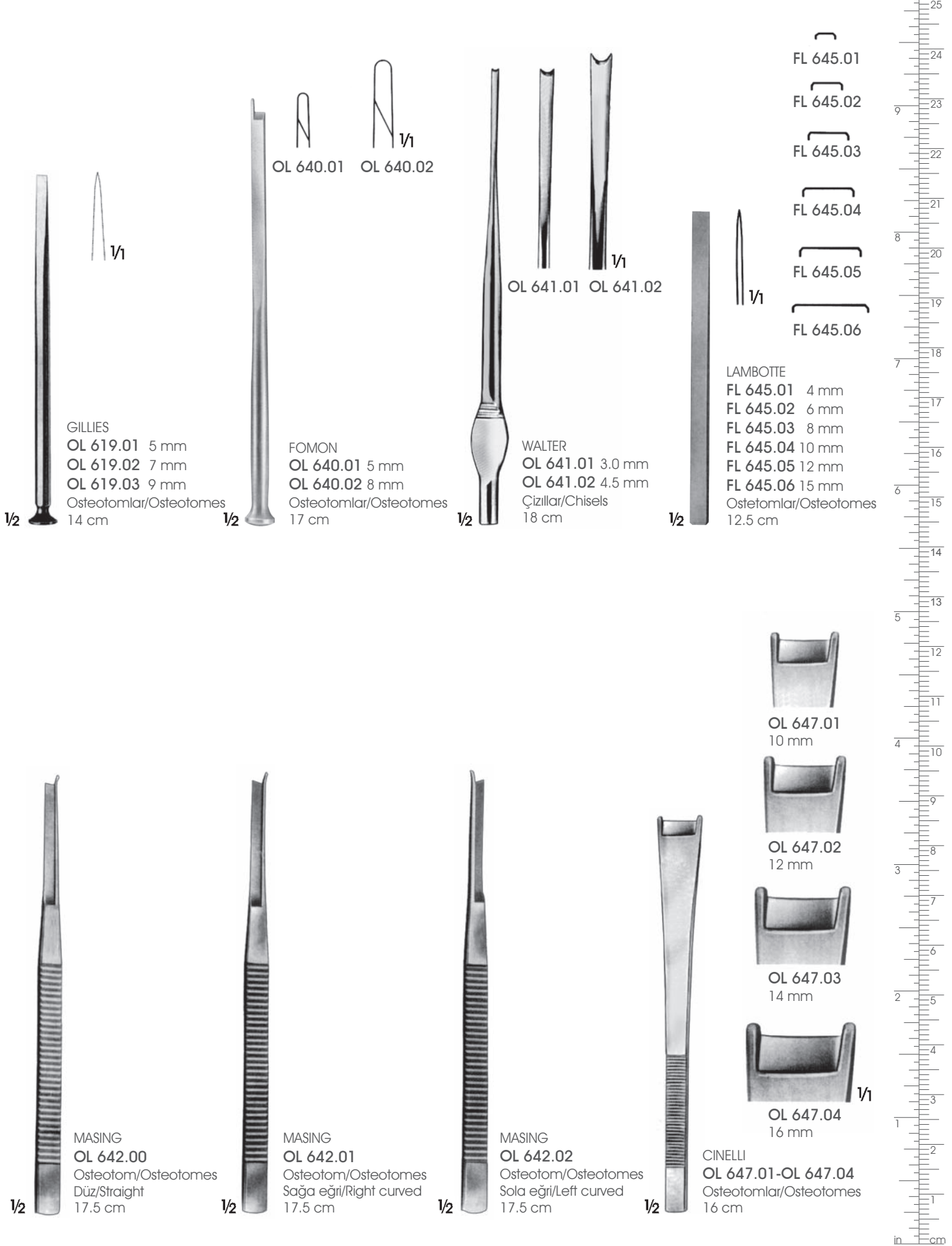

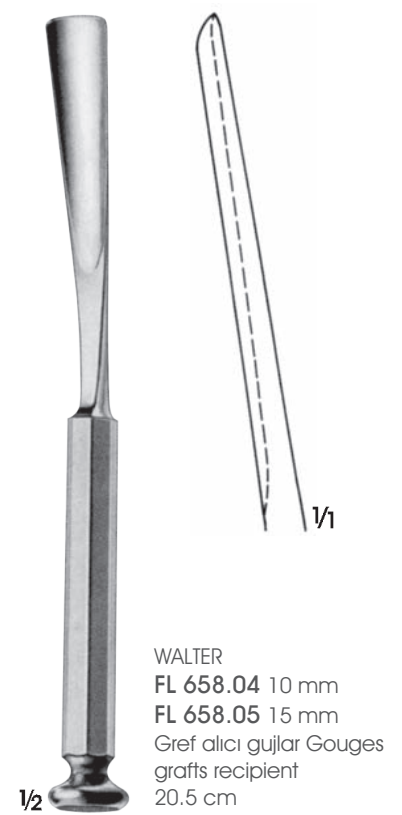
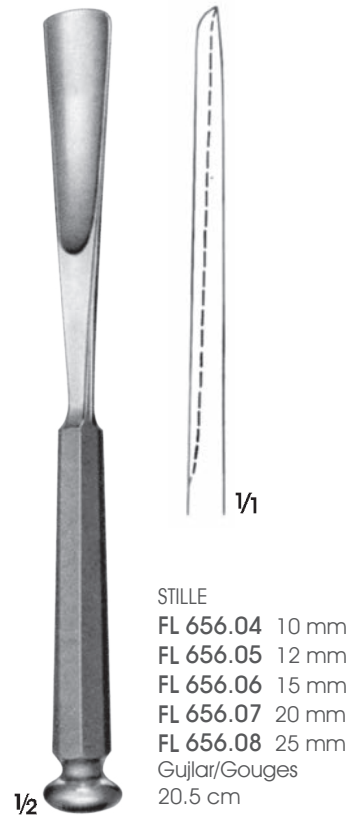
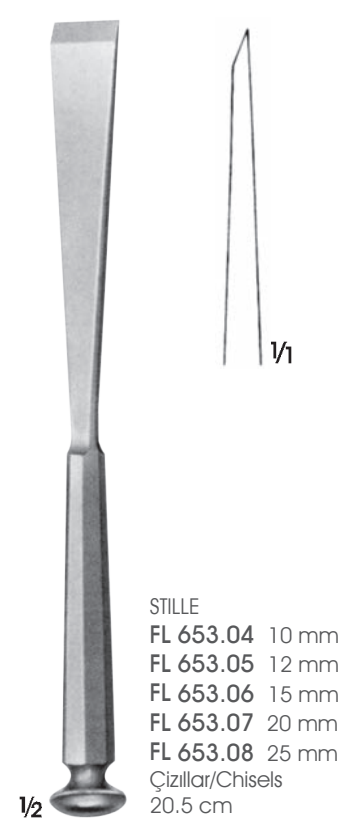
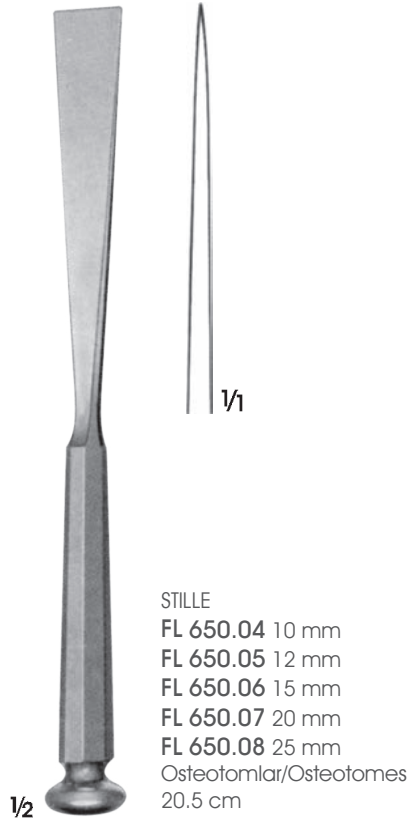



HIBBS

MB 660.01	6 mm
MB 660.08	10 mm
MB 660.02	13 mm
MB 660.09	16 mm
MB 660.03	19 mm
MB 660.10	22 mm
MB 660.04	25 mm
MB 660.11	28 mm
MB 660.05	32 mm
MB 660.13	38 mm

Osteotomlar
Osteotomes
24 cm

HIBBS

MB 661.01	6 mm
MB 661.08	10 mm
MB 661.02	13 mm
MB 661.09	16 mm
MB 661.03	19 mm
MB 661.10	22 mm
MB 661.04	25 mm
MB 661.11	28 mm
MB 661.05	32 mm
MB 661.13	38 mm

Osteotomlar
Osteotomes
24 cm

SMITH-PETERSEN

MB 670.01	7 mm
MB 670.02	11 mm
MB 670.03	14 mm
MB 670.04	17 mm
MB 670.05	19 mm
MB 670.06	25 mm
MB 670.07	32 mm

Osteotomlar
Osteotomes
20.5 cm

SMITH-PETERSEN

MB 671.01	6 mm
MB 671.02	9.5 mm
MB 671.03	13 mm
MB 671.04	16 mm
MB 671.05	19 mm
MB 671.06	25 mm
MB 671.07	32 mm

Osteotomlar
Osteotomes
20.5 cm

HIBBS

MB 662.01	6 mm
MB 662.02	13 mm
MB 662.03	19 mm
MB 662.04	25 mm
MB 662.05	32 mm

Osteotomlar
Osteotomes
24 cm

HIBBS

MB 664.01	6 mm
MB 664.02	13 mm
MB 664.03	19 mm
MB 664.04	25 mm
MB 664.05	32 mm

Gujlar/Gouges
24 cm

HIBBS

MB 665.01	6 mm
MB 665.02	13 mm
MB 665.03	19 mm
MB 665.04	25 mm
MB 665.05	32 mm

Gujlar/Gouges Eğri/
Curved
24 cm

SMITH-PETERSEN

MB 673.01	6 mm
MB 673.02	9 mm
MB 673.03	13 mm
MB 673.04	16 mm
MB 673.05	19 mm
MB 673.06	25 mm
MB 673.07	32 mm

Gujlar/Gouges
20.5 cm

SMITH-PETERSEN

MB 674.01	6 mm
MB 674.02	9 mm
MB 674.03	13 mm
MB 674.04	16 mm
MB 674.05	19 mm
MB 674.06	25 mm
MB 674.07	32 mm

Gujlar/Gouges
20.5 cm

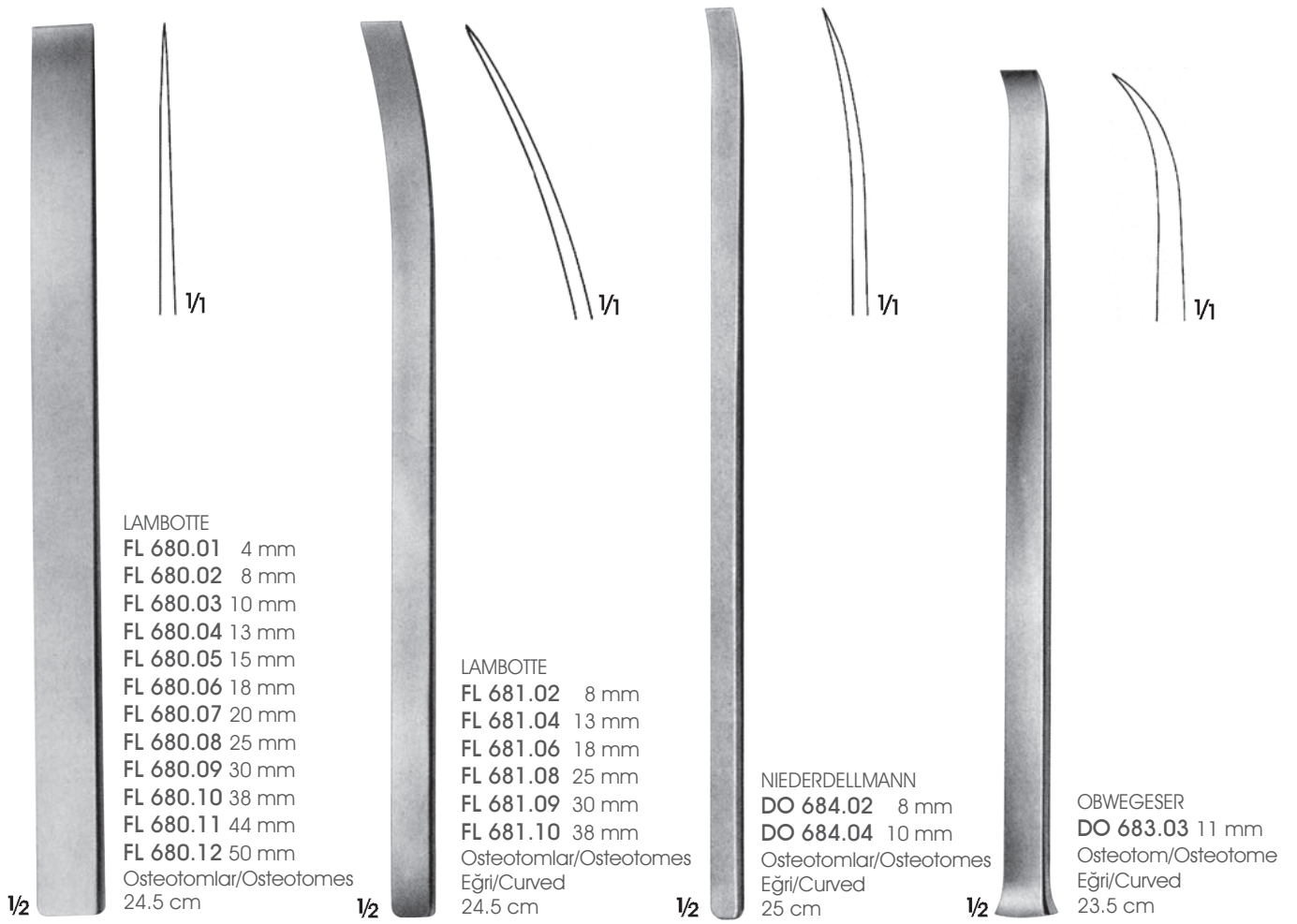

143° buhar sterilizatörlerinde steril edilebilir.
Can be sterilized in a steam sterilizer up to 143°



V 606.05
Anahtar/Key

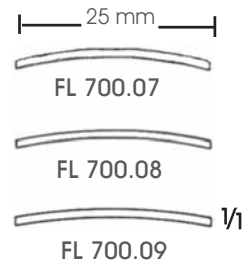

FL 700.00P
Değiştirilebilir bıçaklı,
çizil
(V 606.05 ile)
Changeable blades,
chisel
(V 606.05 with key)

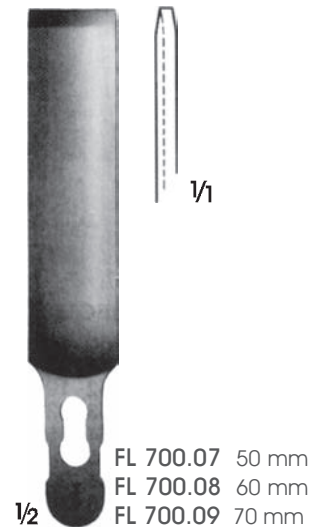
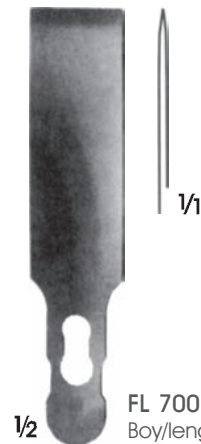

143° buhar sterilizatörlerinde steril edilebilir.
Can be sterilized in a steam sterilizer up to 143°

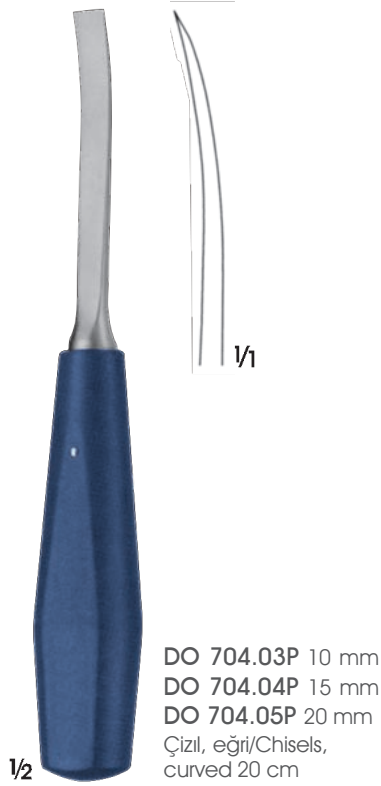
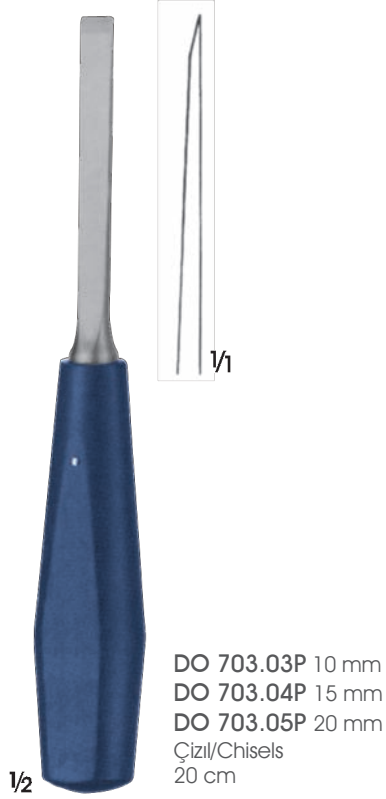
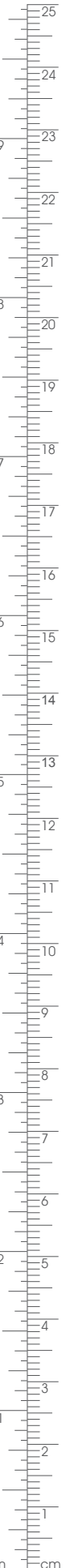

143° buhar sterilizatörlerinde steril edilebilir.
Can be sterilized in a steam sterilizer up to 143°



143° buhar sterilizatörlerinde steril edilebilir.
Can be sterilized in a steam sterilizer up to 143°



FL 720.05P 20 mm
Çizil/Chisels
24.5 cm



ND 721.04P
16 mm Çizil, eğri
Chisel, curved 26.5
cm



LEXER
ND 723.04P 10 mm
ND 723.05P 15 mm
Osteotomlar, açılı
Osteotomes angled
27.5 cm



143° buhar sterilizatörlerinde steril edilebilir.
Can be sterilized in a steam sterilizer up to 143°

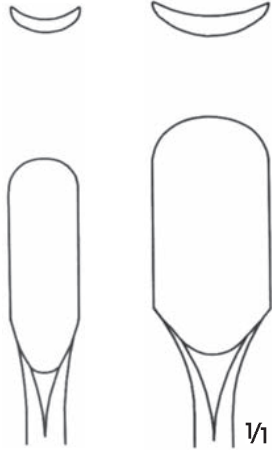

Öne eğimli
Inclined forward

ND 727.01P 9 mm
ND 727.02P 15 mm



Geri eğimli
Inclined backward

ND 728.01P 9 mm
ND 728.02P 15 mm



Düz/straight

ND 729.01P 9 mm
ND 729.02P 15 mm

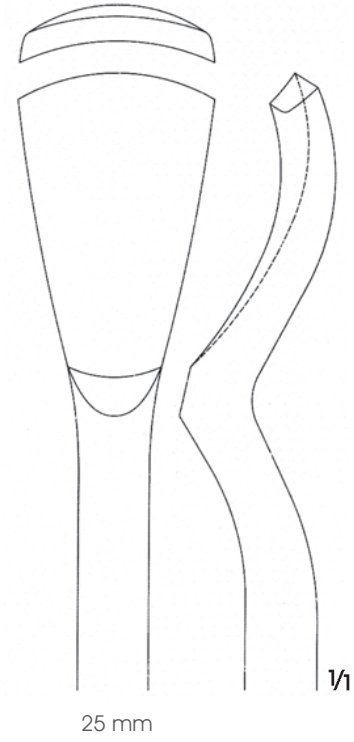

25 mm

1/1



1/2

WAGNER
ND 727.01P-ND 727.02P
ND 728.01P-ND 728.02P
ND 729.01P-ND 729.02P
34 cm



1/2

ND 737.01P
29 cm

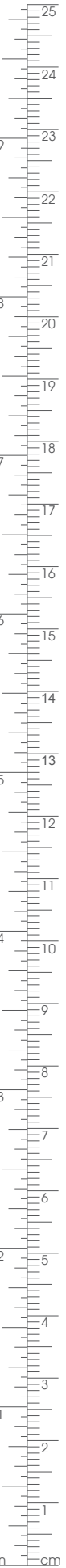



8 mm



COBB
ND 740.02
28 cm

1/2

8 mm



COBB
ND 741.02
28 cm

1/2

8 mm



COBB
ND 742.02
28 cm

1/2

8 mm



COBB
ND 743.02
28 cm

1/2

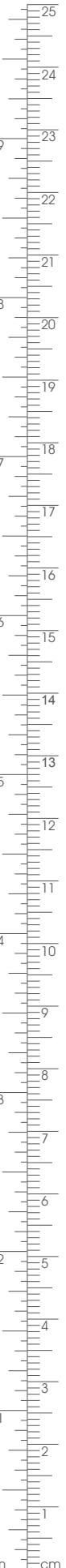
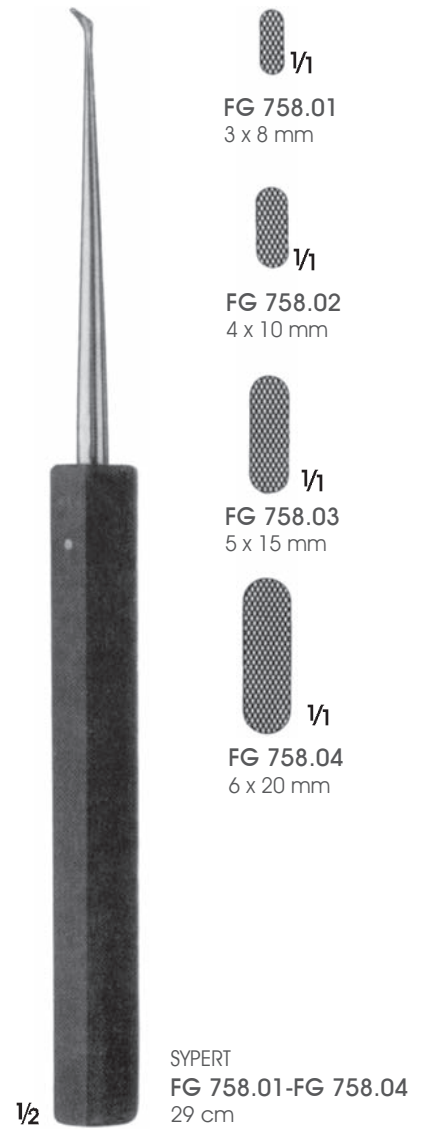
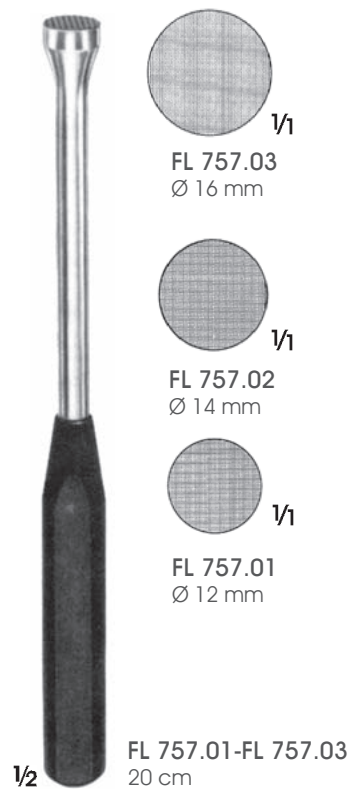
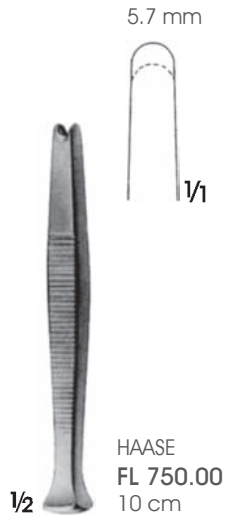

Çekicinin başlıklarına göre ağırlıkları değişebilir
Weights refer to heads of the mallets



Çekicinin başlıklarına göre ağırlıkları değişebilir
Weights refer to heads of the mallets

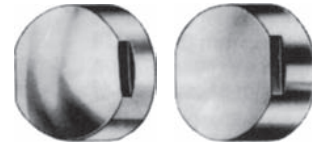

FL 803.02 215 gr. 1
Metal disk, düz
1 Metal disc, flat
1 Metal disk, konveks
1 Metal disc, convex

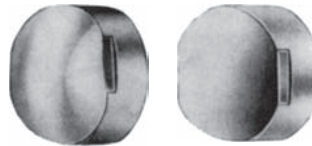

FL 803.03 30 gr.
1 Plastik disk, düz
1 Plastic disc, flat
1 Plastik disk, konveks
1 Plastic disc, convex



FL 803.10
Anahtar/Wrench



Çekicinin başlıklarına göre ağırlıkları değişebilir
Weights refer to heads of the mallets



Çekicinin başlıklarına göre ağırlıkları değişebilir
Weights refer to heads of the mallets



FG Kemik Küretleri
Bone Curettes



 **ARGENT**

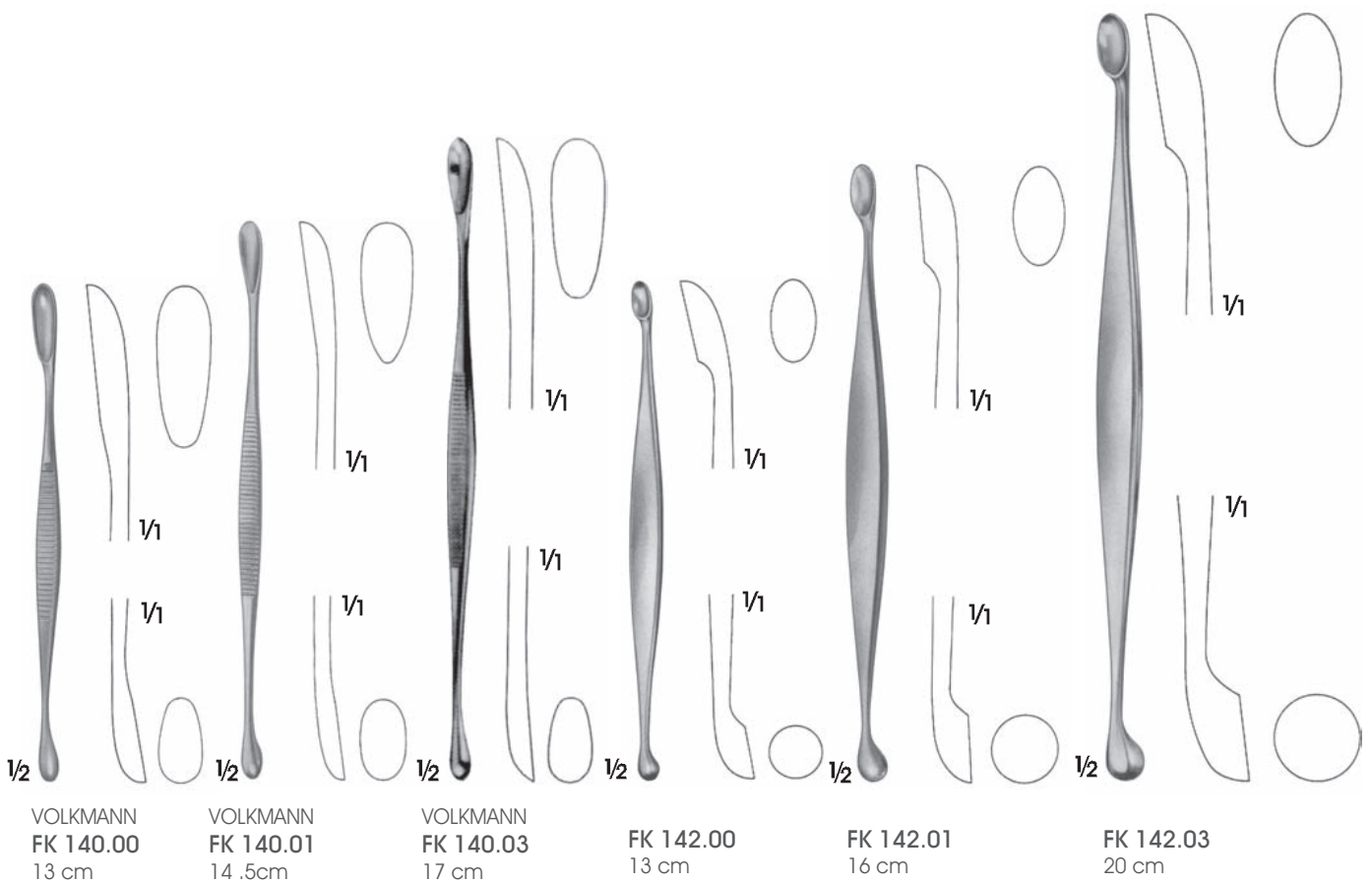
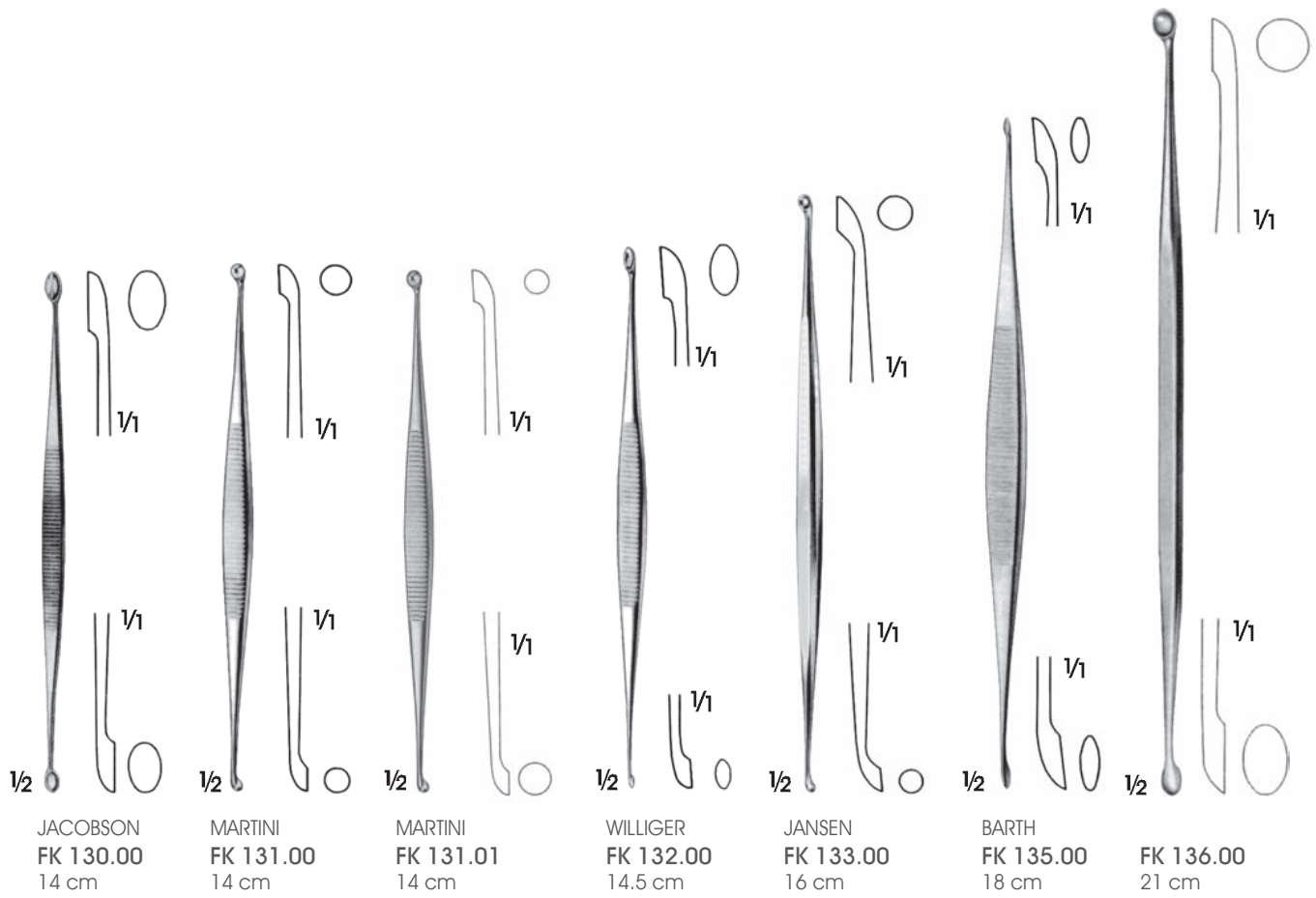

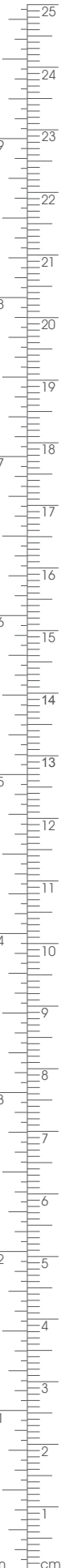
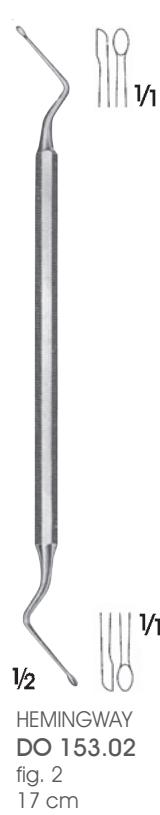
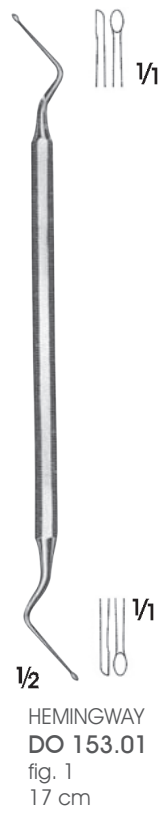
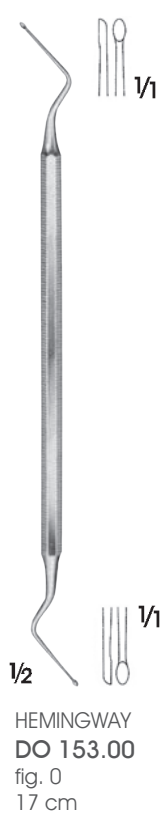
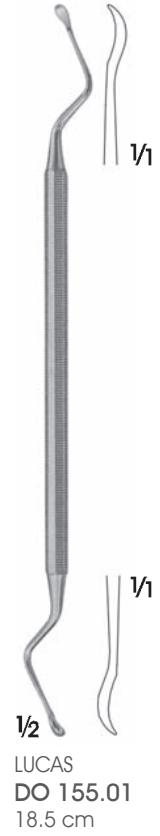
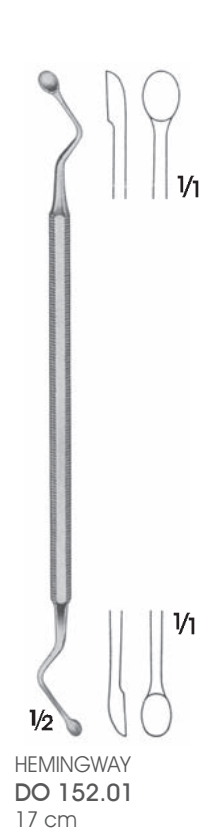
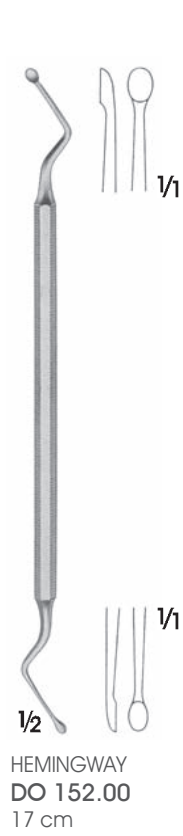

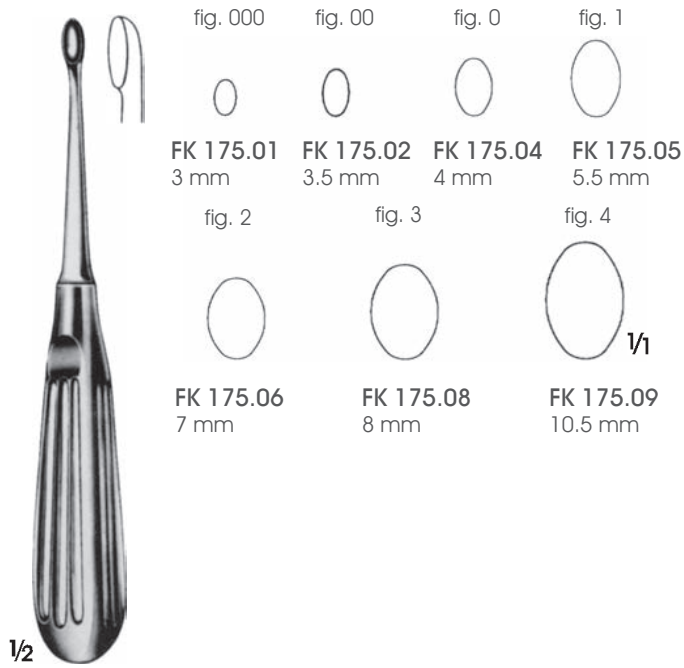

$\frac{1}{2}$
SCHEDE
FK 175.01-FK 175.09
17 cm

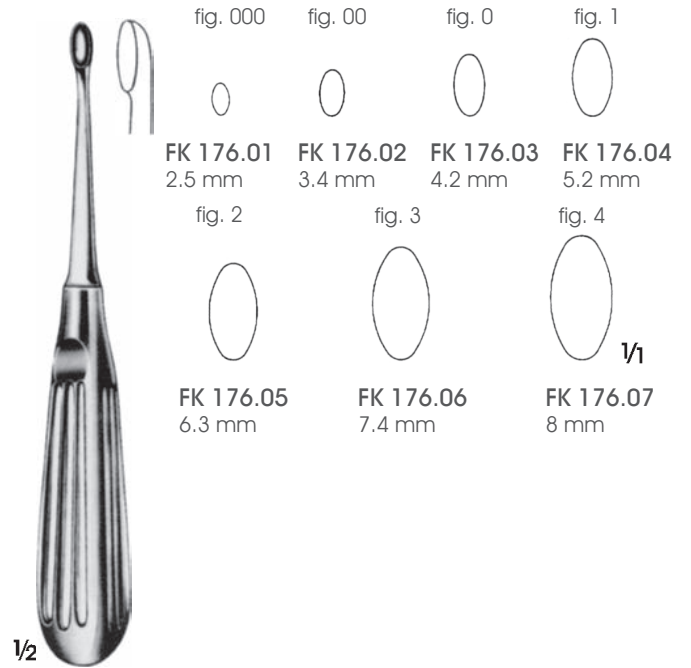

$\frac{1}{2}$
SCHEDE
FK 176.01-FK 176.07
17 cm

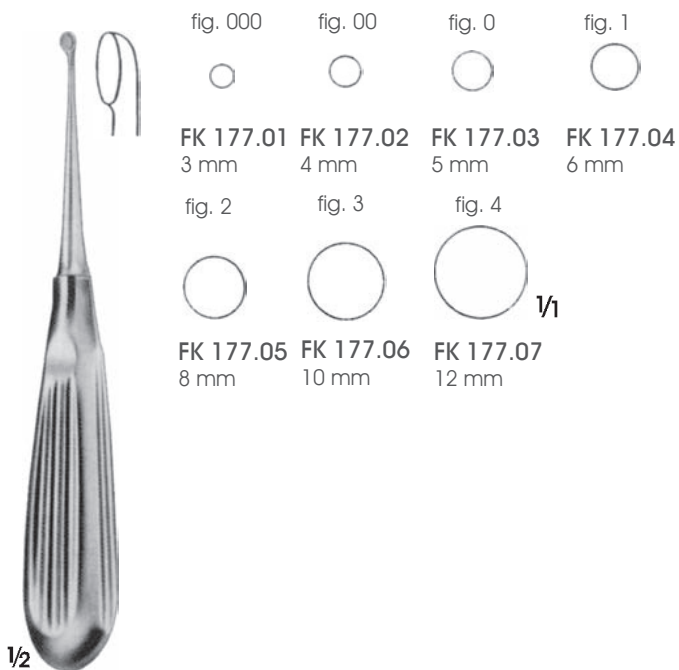

$\frac{1}{2}$
BRUNS
FK 177.01-FK 177.07
16.5 cm

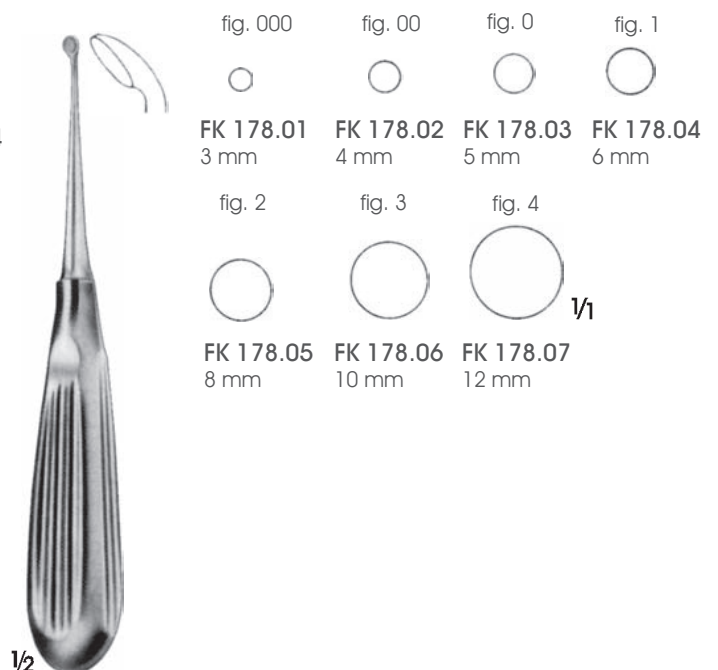

$\frac{1}{2}$
BRUNS
FK 178.01-FK 178.07
16.5 cm

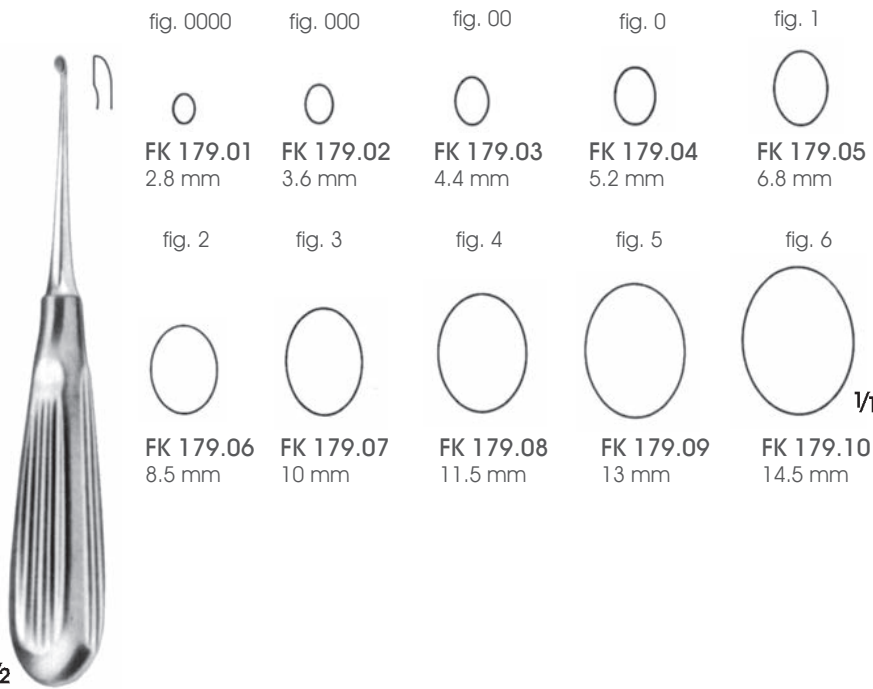

fig. 0000 FK 179.01 2.8 mm	fig. 000 FK 179.02 3.6 mm	fig. 00 FK 179.03 4.4 mm	fig. 0 FK 179.04 5.2 mm	fig. 1 FK 179.05 6.8 mm
fig. 2 FK 179.06 8.5 mm	fig. 3 FK 179.07 10 mm	fig. 4 FK 179.08 11.5 mm	fig. 5 FK 179.09 13 mm	fig. 6 FK 179.10 14.5 mm

1/2

VOLKMANN
FK 179.01-FK 179.10
17 cm



fig. 00 FK 180.01 3.4 mm
fig. 1 FK 180.02 5.2 mm

1/2

WILLIGER
FK 180.01-FK 180.02
17 cm

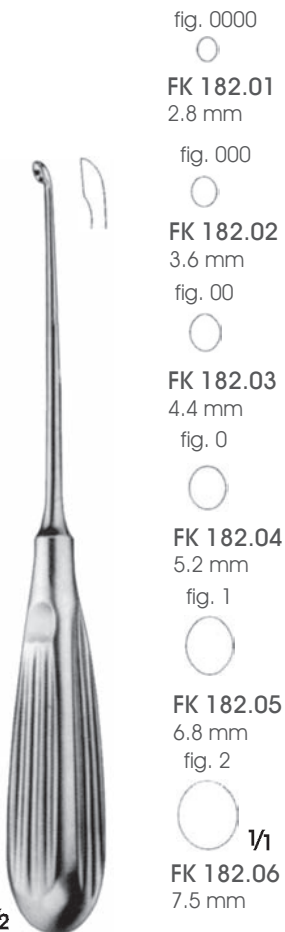

fig. 0000 FK 182.01 2.8 mm
fig. 000 FK 182.02 3.6 mm
fig. 00 FK 182.03 4.4 mm
fig. 0 FK 182.04 5.2 mm
fig. 1 FK 182.05 6.8 mm
fig. 2 FK 182.06 7.5 mm

1/2

FK 182.01-FK 182.06
20 cm



fig. 0000 FK 183.01 2.8 mm
fig. 000 FK 183.02 3.6 mm
fig. 00 FK 183.03 4.4 mm
fig. 0 FK 183.04 5.2 mm
fig. 1 FK 183.05 6.8 mm
fig. 2 FK 183.06 7.5 mm

1/2

FK 183.01-FK 183.06
20 cm









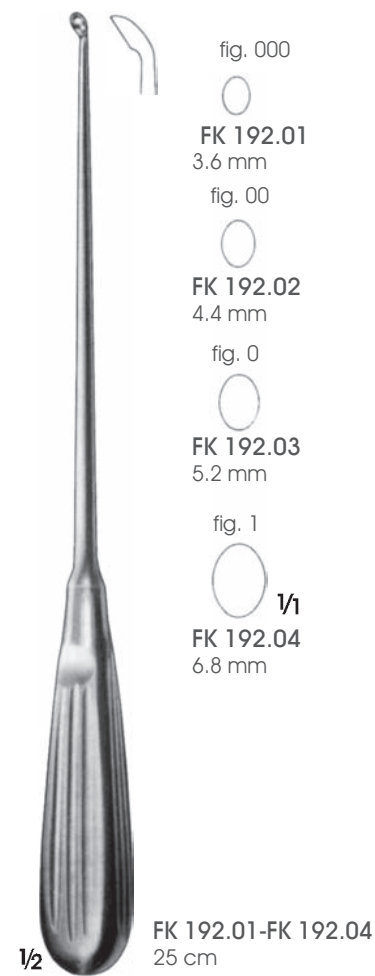
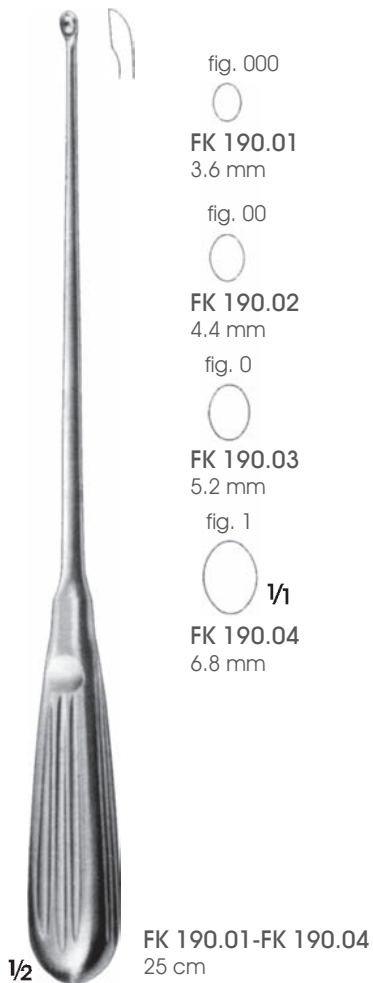
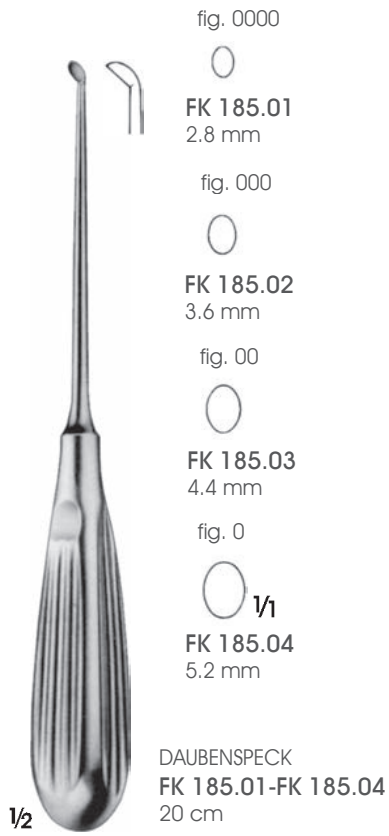

fig. 0000 FK 184.01 2.8 mm
fig. 000 FK 184.02 3.6 mm
fig. 00 FK 184.03 4.4 mm
fig. 0 FK 184.04 5.2 mm
fig. 1 FK 184.05 6.8 mm
fig. 2 FK 184.06 7.5 mm

1/2

FK 184.01-FK 184.06
20 cm



								
Fig.000	Fig.00	Fig.0	Fig.1	Fig.2	Fig.3	Fig.4	Fig.5	Fig.6 $\frac{1}{1}$
FK 200.01 1.8 mm	FK 200.02 2.2 mm	FK 200.03 3.5 mm	FK 200.04 4.0 mm	FK 200.05 4.5 mm	FK 200.06 5.5 mm	FK 200.07 7.2 mm	FK 200.08 8.5 mm	FK 200.09 10.5 mm
FK 202.01 1.8 mm	FK 202.02 2.2 mm	FK 202.03 3.5 mm	FK 202.04 4.0 mm	FK 202.05 4.5 mm	FK 202.06 5.5 mm	FK 202.07 7.2 mm	FK 202.08 8.5 mm	FK 202.09 10.5 mm
FK 203.01 1.8 mm	FK 203.02 2.2 mm	FK 203.03 3.5 mm	FK 203.04 4.0 mm	FK 203.05 4.5 mm	FK 203.06 5.5 mm	FK 203.07 7.2 mm	FK 203.08 8.5 mm	FK 203.09 10.5 mm



EPSTEIN
FK 200.01-FK 200.09
20 cm



HIBBS-SPRATT
FK 202.01-FK 202.09
20 cm



HIBBS-SPRATT
FK 203.01-FK 203.09
20 cm





FK 205.01 1.8 mm	FK 205.02 2.2 mm	FK 205.03 3.5 mm	FK 205.04 4.0 mm	FK 205.05 4.5 mm	FK 205.06 5.5 mm	FK 205.07 7.2 mm	FK 205.08 8.5 mm	FK 205.09 10.5 mm
FK 206.01 1.8 mm	FK 206.02 2.2 mm	FK 206.03 3.5 mm	FK 206.04 4.0 mm	FK 206.05 4.5 mm	FK 206.06 5.5 mm	FK 206.07 7.2 mm	FK 206.08 8.5 mm	FK 206.09 10.5 mm
MB 210.01 1.8 mm	MB 210.02 2.2 mm	MB 210.03 3.5 mm	MB 210.04 4.0 mm	MB 210.05 4.5 mm	MB 210.06 5.5 mm	MB 210.07 7.2 mm	MB 210.08 8.5 mm	MB 210.09 10.5 mm
FK 211.01 1.8 mm	FK 211.02 2.2 mm	FK 211.03 3.5 mm	FK 211.04 4.0 mm	FK 211.05 4.5 mm	FK 211.06 5.5 mm	FK 211.07 7.2 mm	FK 211.08 8.5 mm	FK 211.09 10.5 mm

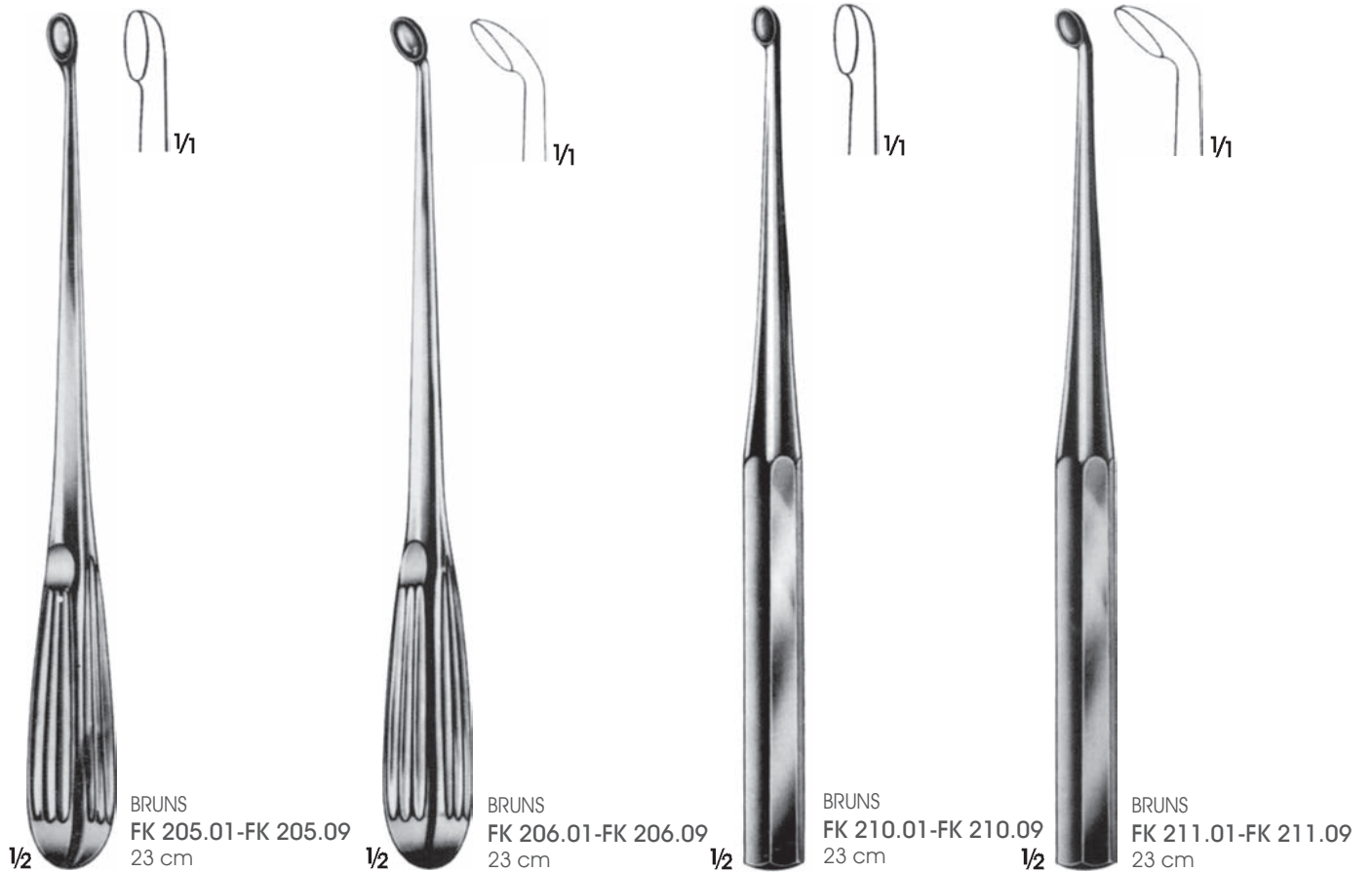

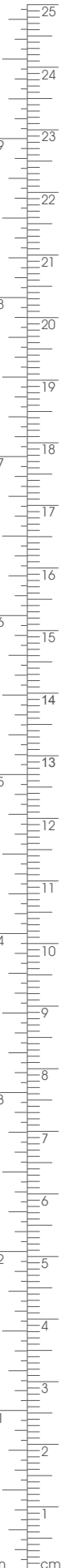
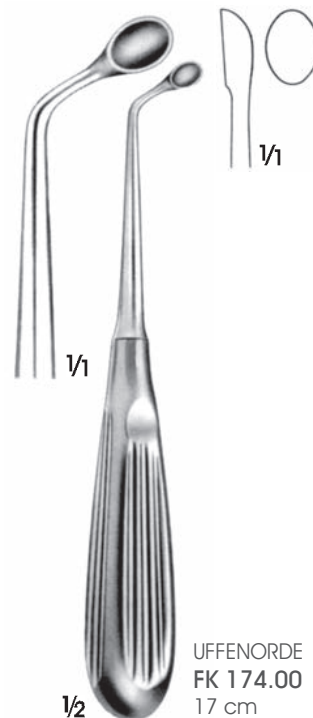
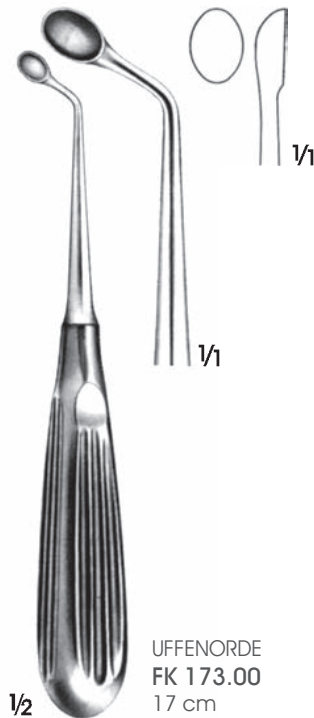



MF 420.00-MF 421.14
21.5 cm

		0000	000	00	0	1
Öne/Forward Düz/Straight		0	0	0	0	0
		MF 420.00	MF 420.01	MF 420.02	MF 420.03	MF 420.04
		0000	000	00	0	1
Öne/Forward Açılı/Angle		0	0	0	0	0
		MF 421.00	MF 421.01	MF 421.02	MF 421.03	MF 421.04
		0000	000	00	0	1
Geriye/Backward Düz/Straight		0	0	0	0	0
		MF 420.10	MF 420.11	MF 420.12	MF 420.13	MF 420.14
		0000	000	00	0	1
Geriye/Backward Açılı/Angle		0	0	0	0	0 1/1
		MF 421.10	MF 421.11	MF 421.12	MF 421.13	MF 421.14



MF 423.00-MF 424.14
24 cm

		0000	000	00	0	1
Öne/Forward Düz/Straight		0	0	0	0	0
		MF 423.00	MF 423.01	MF 423.02	MF 423.03	MF 423.04
		0000	000	00	0	1
Öne/Forward Açılı/Angle		0	0	0	0	0
		MF 424.00	MF 424.01	MF 424.02	MF 424.03	MF 424.04
		0000	000	00	0	1
Geriye/Backward Düz/Straight		0	0	0	0	0
		MF 423.10	MF 423.11	MF 423.12	MF 423.13	MF 423.14
		0000	000	00	0	1
Geriye/Backward Açılı/Angle		0	0	0	0	0 1/1
		MF 424.10	MF 424.11	MF 424.12	MF 424.13	MF 424.14



MF 430.00-MF 432.02
24 cm

Geriyeye/Backward
Düz/Straight



0

1

2



MF 430.00 MF 430.01 MF 430.02

Geriyeye/Backward
Açılı/Angle



0

1

2



MF 431.00 MF 431.01 MF 431.02

Geriyeye/Backward
Aşağı/Down



0

1

2



MF 432.00 MF 432.01 MF 432.02



MF 430.10-MF 432.12
24 cm

Öne/Forward
Düz/Straight



0

1

2



MF 430.10 MF 430.11 MF 430.12

Öne/Forward
Açılı/Angle



0

1

2



MF 431.10 MF 431.11 MF 431.12

Öne/Forward
Aşağı/Down



0

1

2



MF 432.10 MF 432.11 MF 432.12





143° buhar sterilizatörlerinde steril edilebilir.
Can be sterilized in a steam sterilizer up to 143°



143° buhar sterilizatörlerinde steril edilebilir.
Can be sterilized in a steam sterilizer up to 143°

	Fig.000		Fig.000
			
	FK 260.01P 3.6 mm		FK 261.01P 3.6 mm
	Fig.00		Fig.00
			
	FK 260.02P 4.4 mm		FK 261.02P 4.4 mm
	Fig.0		Fig.0
			
	FK 260.03P 5.2 mm		FK 261.03P 5.2 mm

	
CASPAR FK 260.01P-FK 260.03P 22 cm	CASPAR FK 261.01P-FK 261.03P 22 cm

			
	FG 283.01 2.8 mm		FG 284.01 2.8 mm
			
	FG 283.02 3.6 mm		FG 284.02 3.6 mm
			
	FG 283.03 5.2 mm		FG 284.03 5.2 mm
			
	FG 283.04 10 mm		FG 284.04 10 mm

	
SYPERT FG 283.01-FG 283.04 38 cm	SYPERT FG 284.01-FG 284.04 38 cm





143° buhar sterilizörlerinde steril edilebilir.
Can be sterilized in a steam sterilizer up to 143°



1/2
ER 600.00P
25 cm

1/2
ER 602.00P
27 cm

1/2
FK 280.01P-FK 280.04P
27 cm

1/2
FK 281.02P
30 cm

1/2
ER 606.00P
32 cm

Fig.00
FK 280.01P
4.4 mm
fig. 1
FK 280.02P
6.8 mm
fig. 2
FK 280.03P
8.5 mm
fig.3
FK 280.04P
10 mm

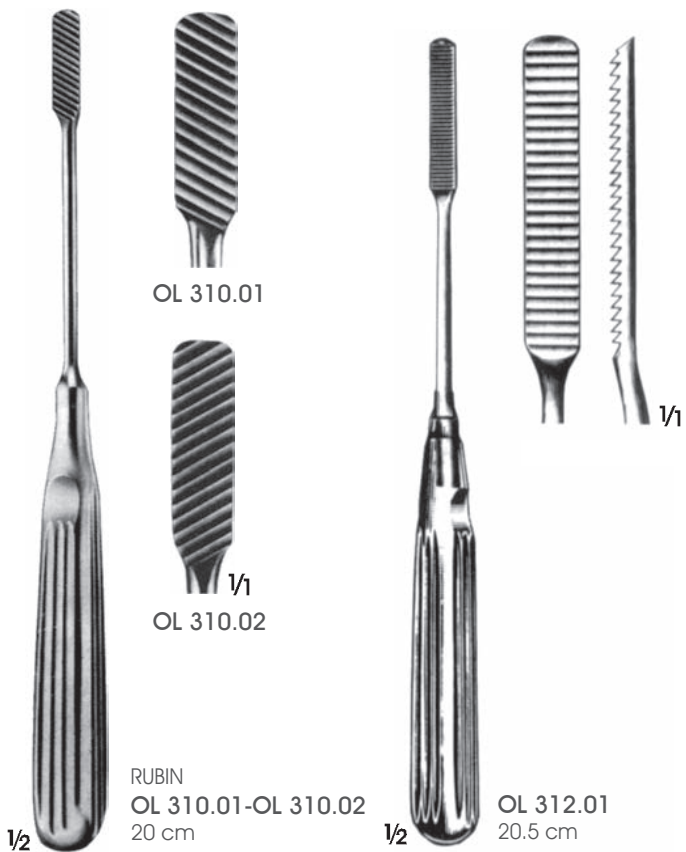
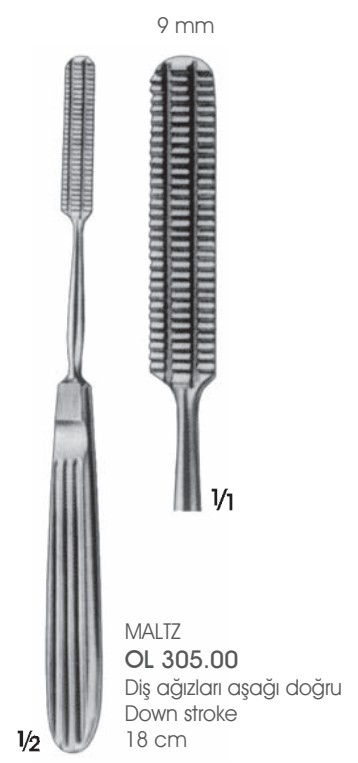

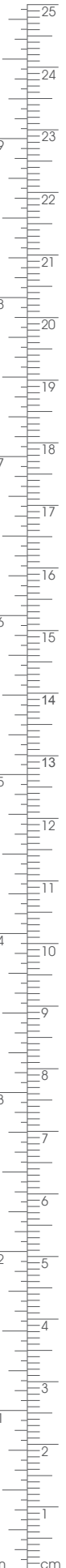
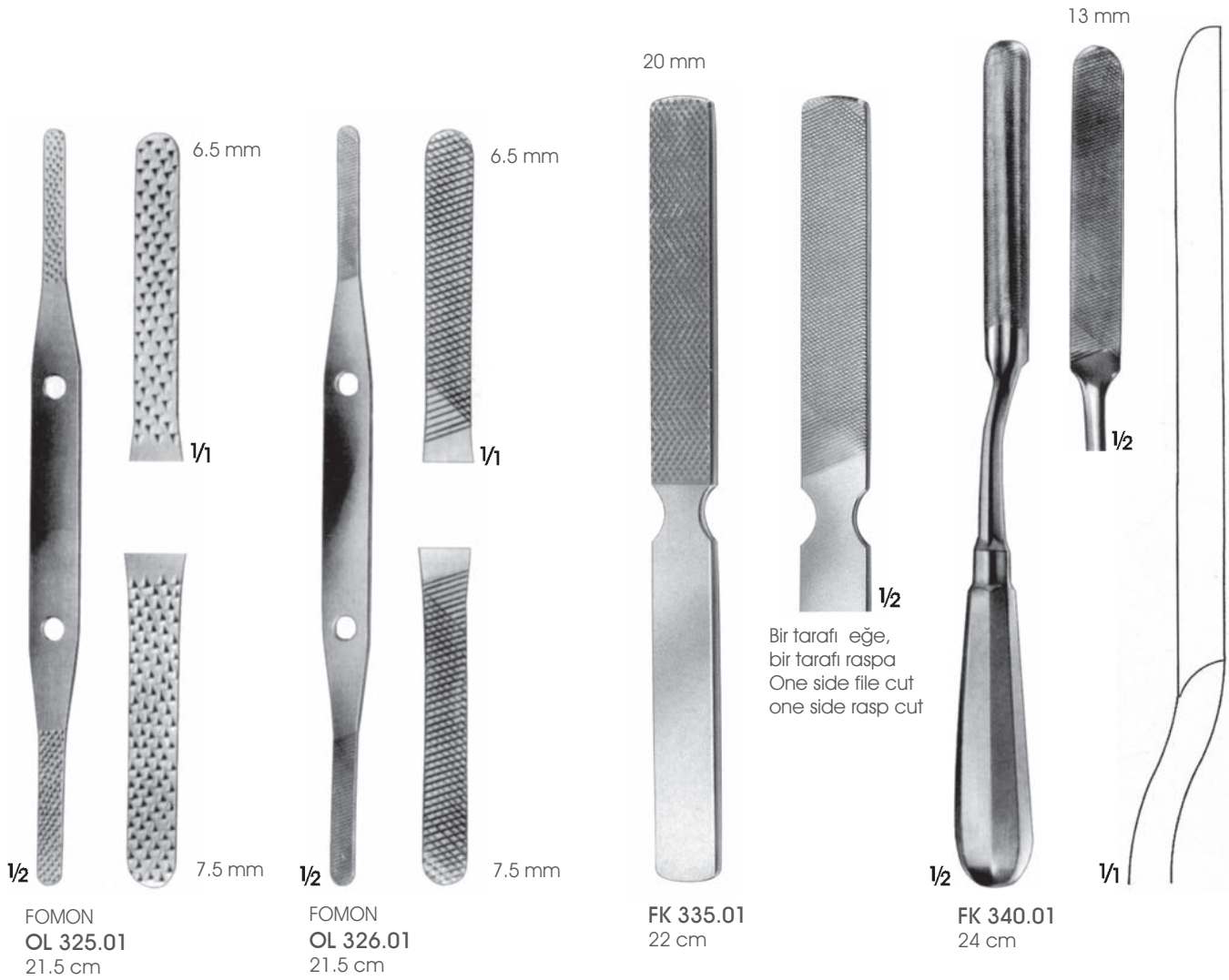
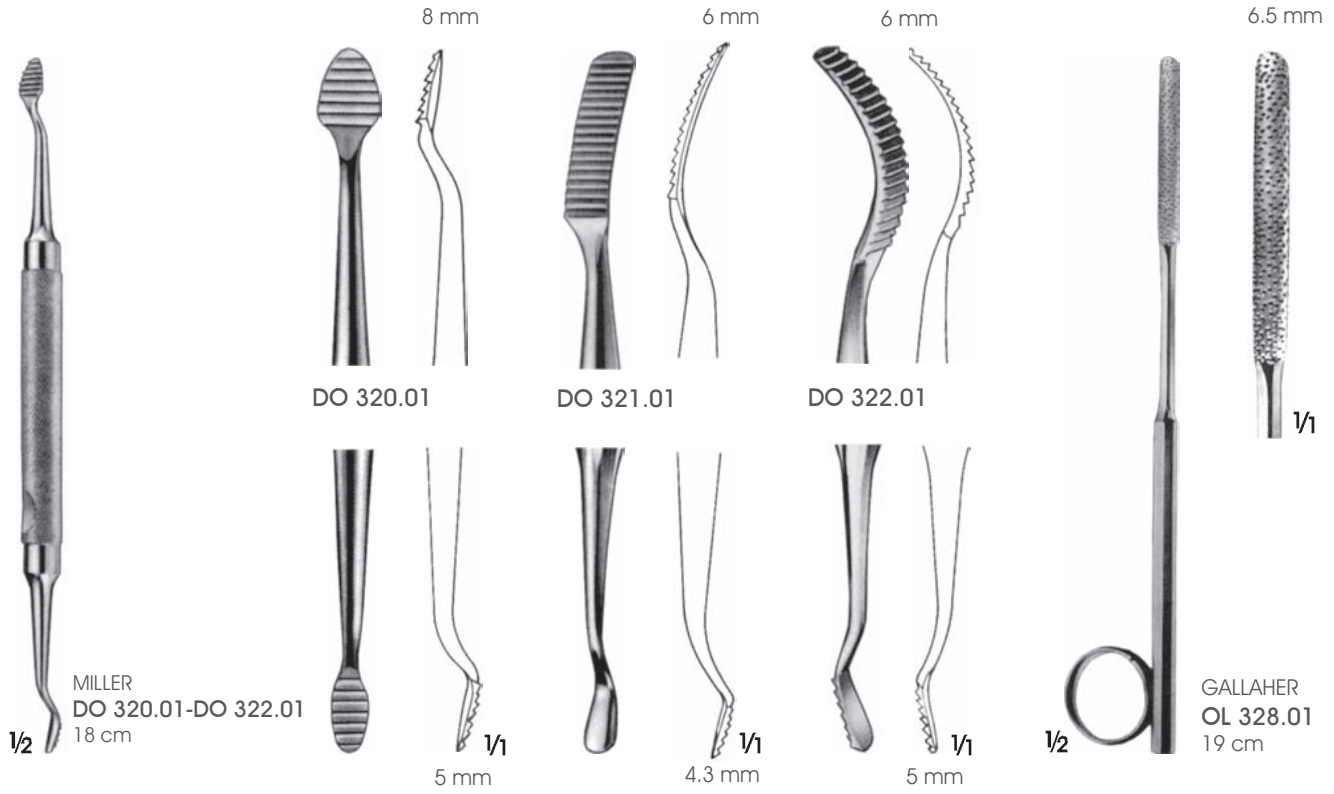

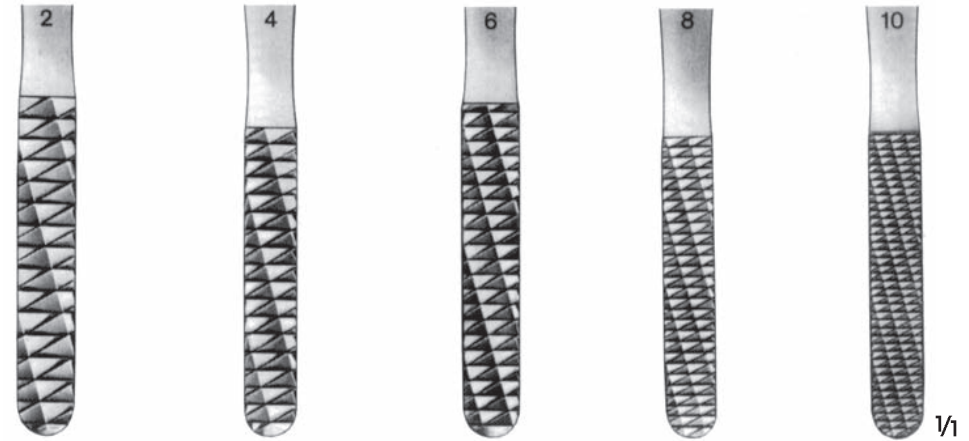
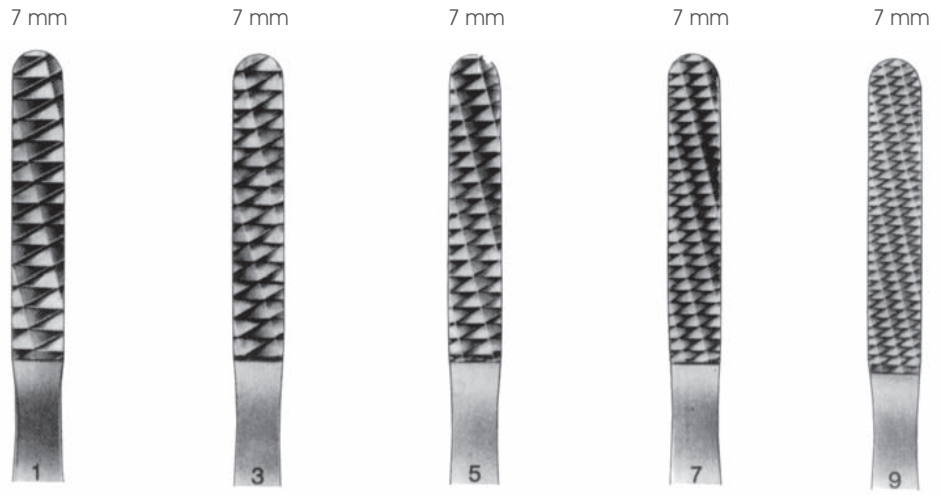

Diş
Teeth

OL 332.01
12/14

OL 332.02
16/20

OL 332.03
24/30

OL 332.04
36/44

OL 332.05
52/62

1/1

1/2

OL 332.01-OL 332.05
20,5 cm

18 mm



$\frac{1}{2}$
20 mm
PUTTI
FK 345.01
27 cm

20 mm



$\frac{1}{2}$
FK 348.01
29.5 cm



$\frac{1}{2}$
PUTTI
FK 347.01
30 cm

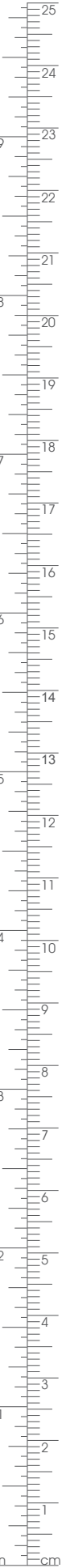

FO Kemik Pensleri, Ronjurları, Makasları ve Pançları
Bone Holding Forceps, Rongeurs, Scissors and Punches



 **ARGENT**

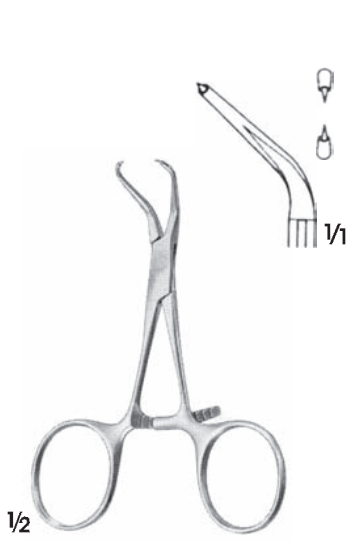

FO 100.00
Setli, pozisyon pensi
Reposition forceps with
stepped tips
9.5 cm



FO 102.00
Küçük parçaları
konumlandırma pens
Reposition forceps for small
fragments
13.5 cm

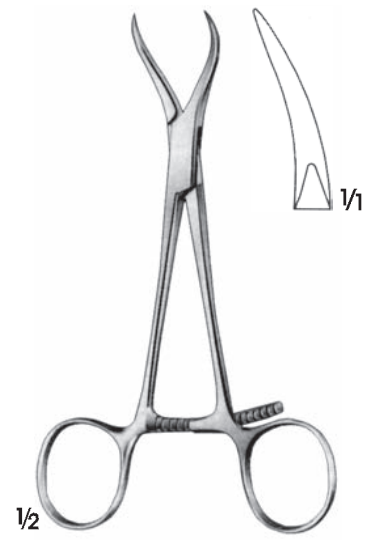

FO 103.00
Çene kemiğine ait
konumlandırma pens
Reposition forceps, especially
for maxillary reposition
13.5 cm



HAASE
FO 105.00
Pozisyon pens, çeneye ait
kırıklar için
Reposition forceps for
mandibular fractures
16.5 cm

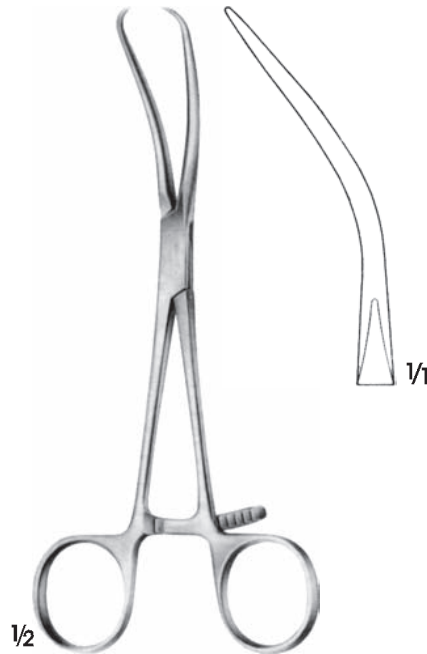

REILL
FO 106.00
Pozisyon pens
Reposition forceps
17 cm



FO 107.01
Pozisyon pens
Reposition forceps
20.5 cm



FÖRSTNER
FO 120.01
14 cm



FO 123.00
13.5 cm



HAASE
FO 124.00
14 cm

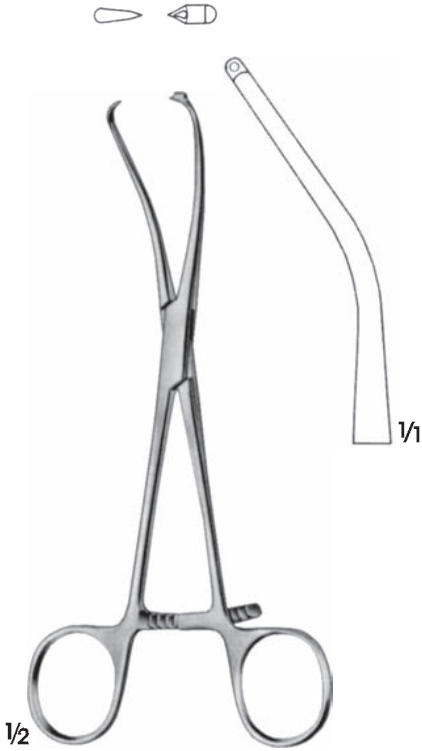

MEYER
FO 110.00
Kışner telleri için matkap kılavuzu,
yeniden konumlandırıcı
Reposition forceps for fingers,
with drill guide for KIRSCHNER
kullanılan tel Ø 1.0 mm
For wires with Ø 1.0 mm
17 cm

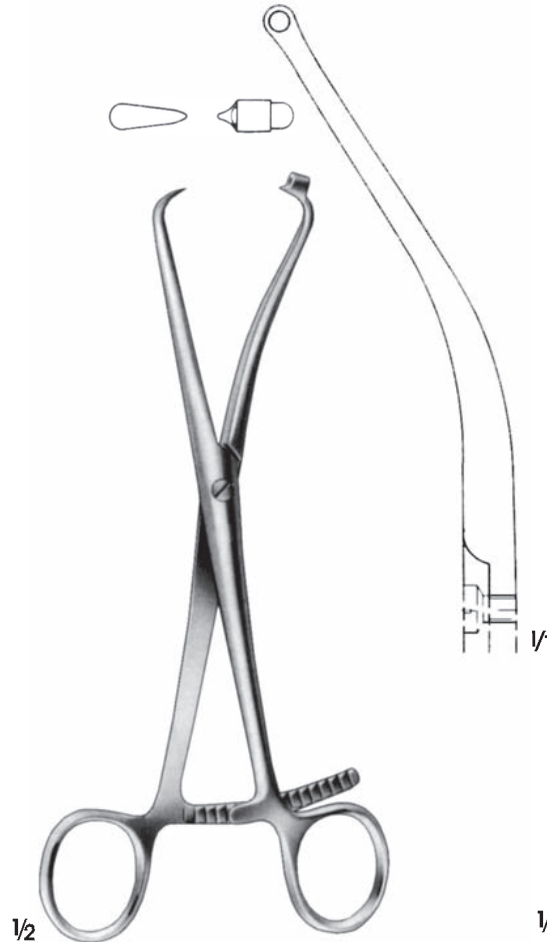

MEYER
FO 112.00
Kışner telleri için matkap kılavuzu,
yeniden konumlandırıcı
Reposition forceps for fingers,
with drill guide for KIRSCHNER
kullanılan tel Ø 2.0 mm
For wires with Ø 2.0 mm
20.5 cm

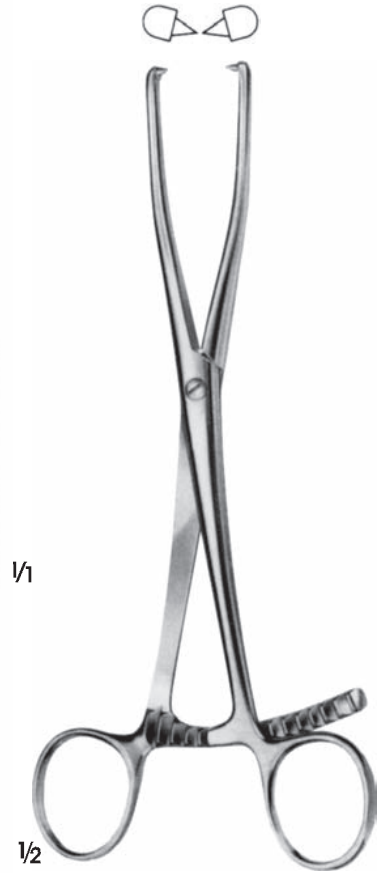

FO 113.00
Malleolus pens
Malleolar forceps
21 cm

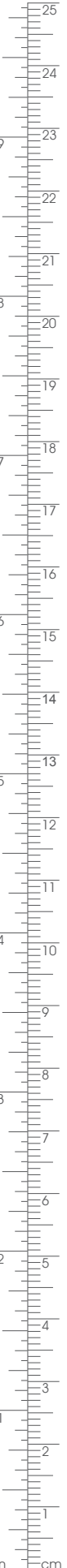



LEWIN
MD 140.01
Kemik klempsi
Bone clamp
18.5 cm

1/2

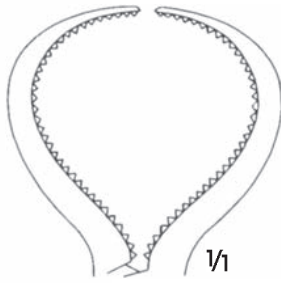

1/1



FO 115.00
Diz kapağı pensi
Patella forceps
18.5 cm

1/2



1/1



FO 130.01
Sekestrum pensi
Sequestrum forceps
20 cm

1/2

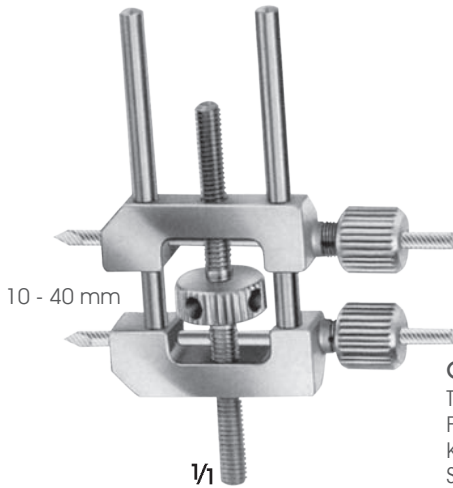

CX 380.00
Tel Ø 3.0 mm
For wires Ø 3.0 mm
Küçük kemikleri yaklaştırma aparatı
Small bones of the zoom apparatus

1/1

Ø 2 mm



WÖRRLEIN
CX 381.00
Pozisyon verici
Positöner/Repositöner
16.5 cm

1/2

1/1

Vidalanabilir kemik parçasını
KIRSCHNER teli kullanarak sabitleme
Position, Re-giver bony part of the wire
can be screwed KIRSCHNER
stabilization using



DINGMANN
FO 125.00
18.5 cm

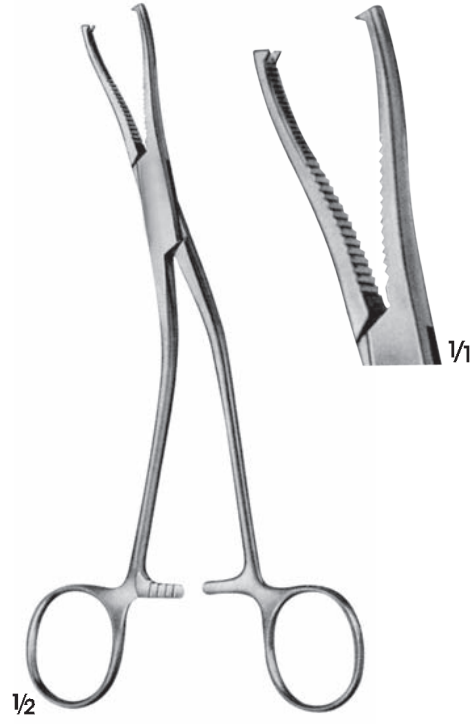

DINGMANN
FO 126.00
18.5 cm



SEMB
FO 135.00
19 cm



SEMB
FO 136.00
19 cm

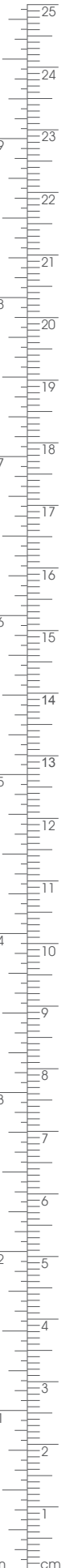



$\frac{1}{2}$
FO 142.00
 Kilitlenebilir, sabitlenebilir pens
 Forceps with ratchet fixation
 14 cm



$\frac{1}{2}$
FO 143.00
 Vida ile sabitlenebilir pens
 Forceps with thread fixation
 17 cm



$\frac{1}{2}$
FO 143.01
 Vida ile sabitlenebilir pens
 Forceps with thread fixation
 23.5 cm



$\frac{1}{2}$
FO 150.00
 Kemik tutma pens
 Bone holding forceps
 20 cm



$\frac{1}{2}$
LANGENBECK
FO 151.00
 Kemik tutma pens
 Bone holding forceps
 20.5 cm



$\frac{1}{2}$
FERGUSON
FO 152.00
 Kemik tutma pens
 Bone holding forceps
 20.5 cm

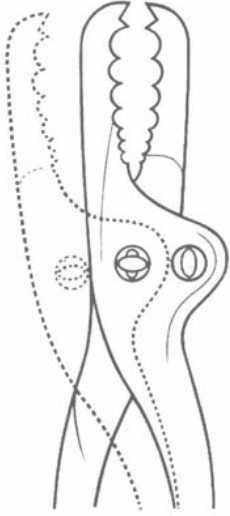

Ayarlanabilir ağız
Jaw adjustable



FARABEUFF
FO 155.00
23cm



FARABEUFF
FO 155.01
25.5 cm



FARABEUFF-LAMBOTTE
FO 156.01
25.5 cm





7.5 mm



1/2

KERN-MINI
FO 161.00
15.5 cm

9 mm



1/2

KERN-LANE
FO 161.01
24 cm

13 mm



1/2

LANE
FO 161.02
32 cm

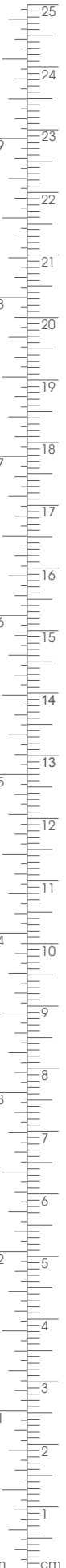



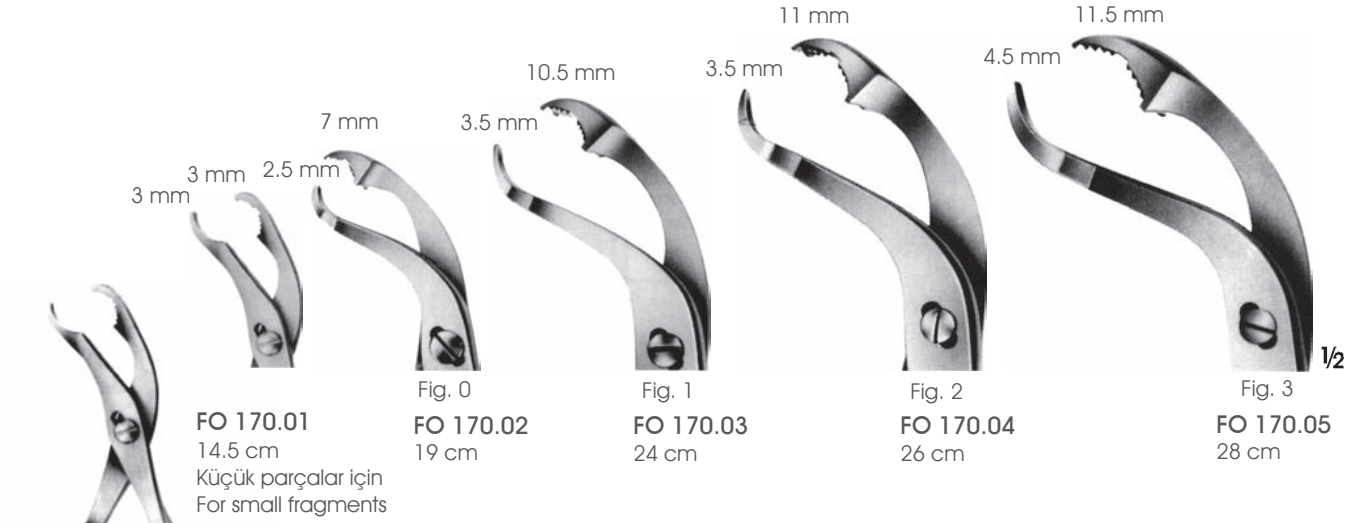

FO 170.01-FO 170.05
Kendi kendini merkezleyici,
vidalı sabit pensler
Self-centering forceps with
thread fixation

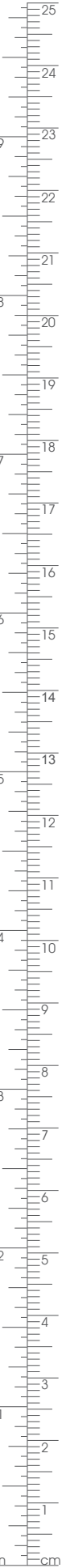
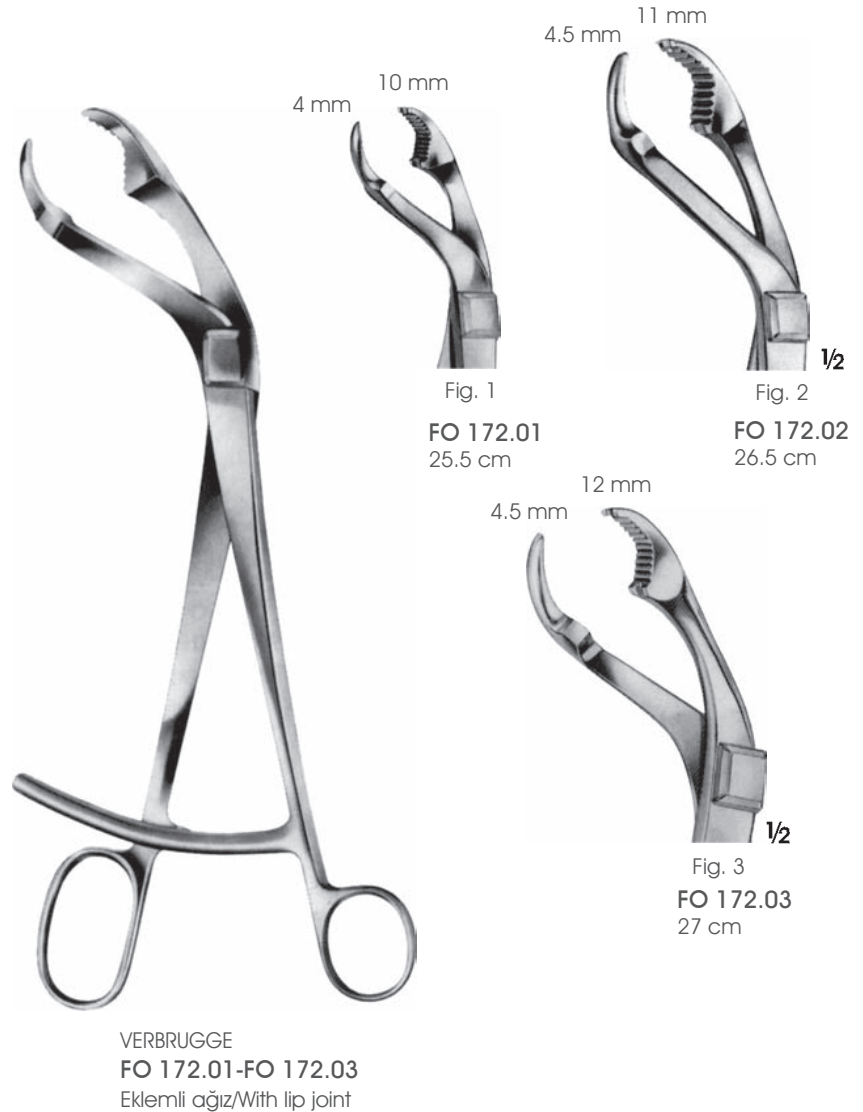

Haraketli çene
Movable jaw



LAMBOTTE
FO 176.01-FO 176.03

Ayarlanabilir çene
Adjustable jaw



Haraketli çene
Movable jaw

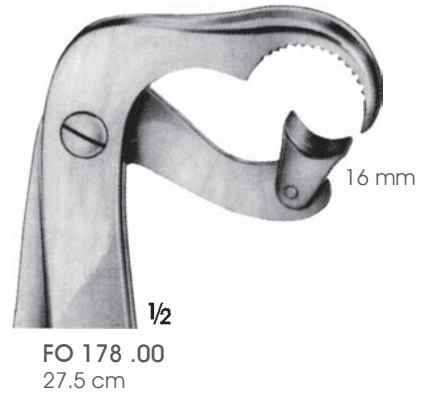

FO 177.00-FO 178.00



LOWMAN
FO 180.00 17 cm
FO 180.01 20.5 cm



$\frac{1}{2}$
LOWMAN-GERSTER
FO 180.02
21 cm



$\frac{1}{2}$
LOWMAN-HOGLUND
FO 183.00
17.5 cm

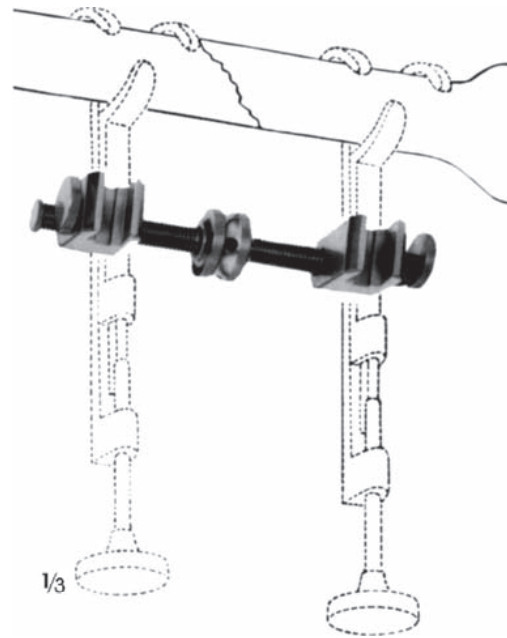

$\frac{1}{3}$
GERSTER
FO 185.00
FO 180.00-FO 183.00 için çekirme çubuğu
Traction bar for FO 180.00-FO 183.00





FO 251.01
Sinovectomi ronjur
Synovectomy rongeur
Çene genişliği 2.0 mm
Width of jaws 2.0 mm
13 cm



STELLBRINK
FO 260.01
Sinovectomi ronjur
Synovectomy rongeur
17.5 cm

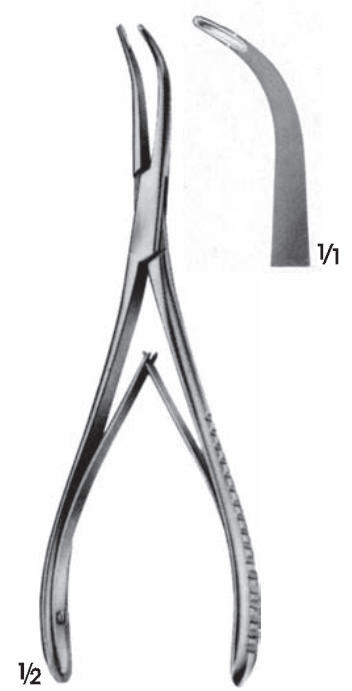

STELLBRINK
FO 260.02
Sinovectomi ronjur
Synovectomy rongeur
17 cm



FRIEDMANN
FO 264.00-FO 264.10
Kemik Ronjur/Bone Ronjur
14 cm

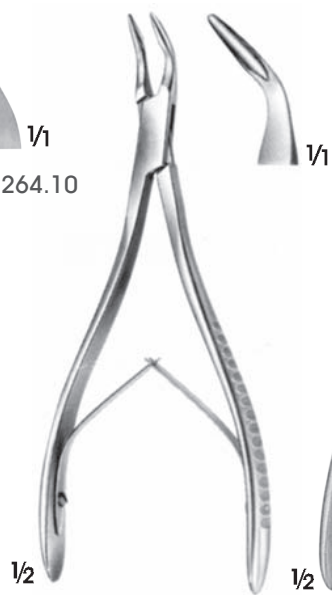

FO 272.01
Kemik Ronjur/Bone Ronjur
15 cm

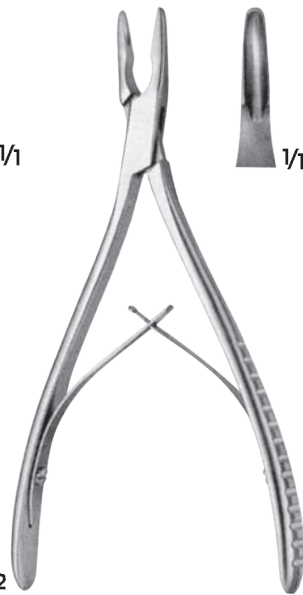

LEMBERT
FO 274.01
Kemik Ronjur/Bone Ronjur
16.5 cm



SCHWARZ
FO 292.01
Kemik Ronjur/Bone Ronjur
14.5 cm



LUER-FRIEDMANN
FO 265.00
Kemik Ronjur/Bone Rongeur
14.5 cm

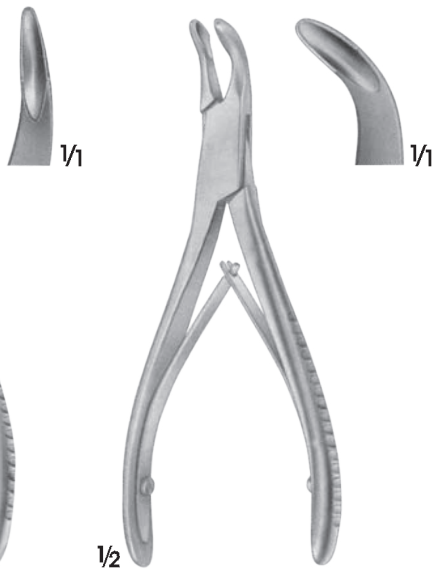

FO 266.00
14 cm



LUER
FO 267.00
15 cm



LUER
FO 268.00
15.5 cm



BLUMENTHAL
FO 270.00
15.5 cm

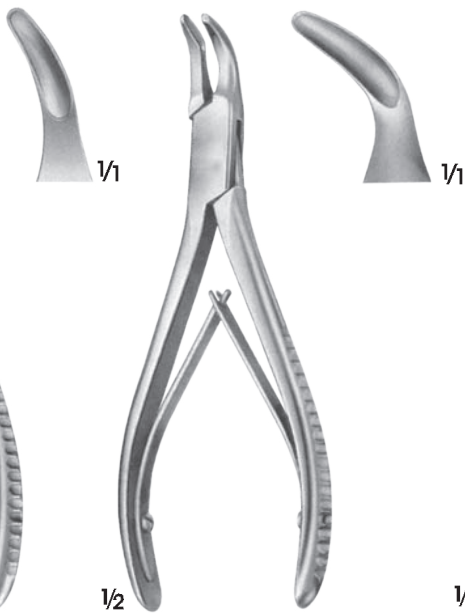

BLUMENTHAL
FO 271.00
15 cm

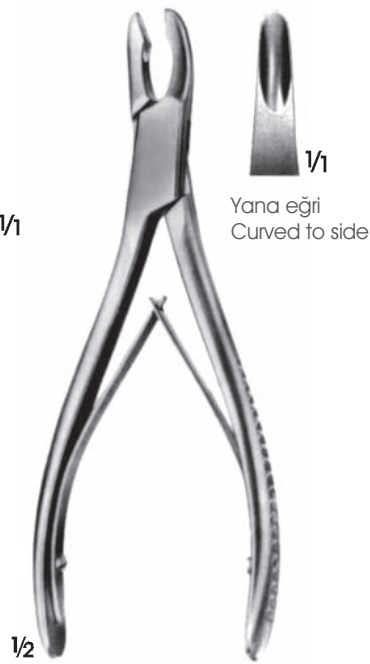

HAKANSSON
FO 275.00
17 cm

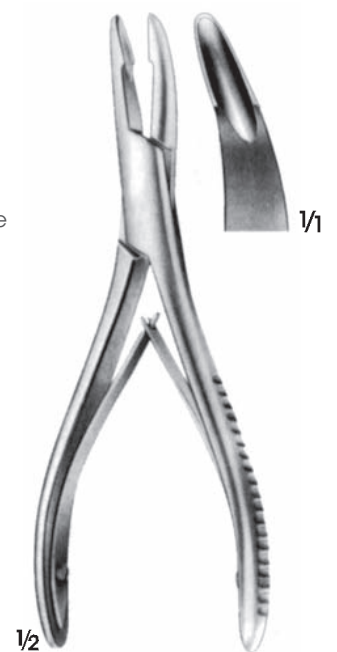

MEAD
FO 276.00
16.5 cm





JANSEN
FO 277.00
17.5 cm



JANSEN
FO 278.00
17.5 cm

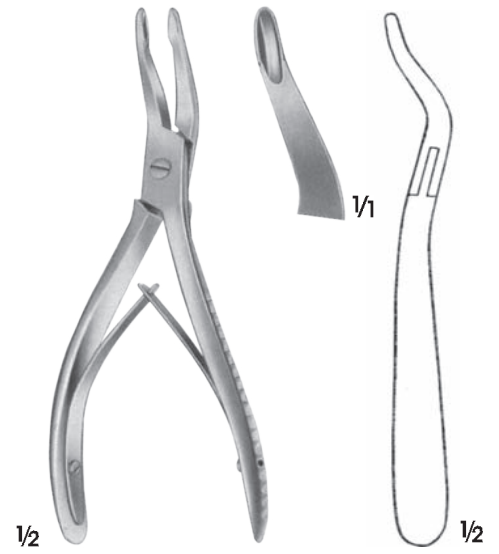

ALEXANDER
FO 280.00
14 cm



LEMPERT
FO 286.00-FO 287.00
20 cm

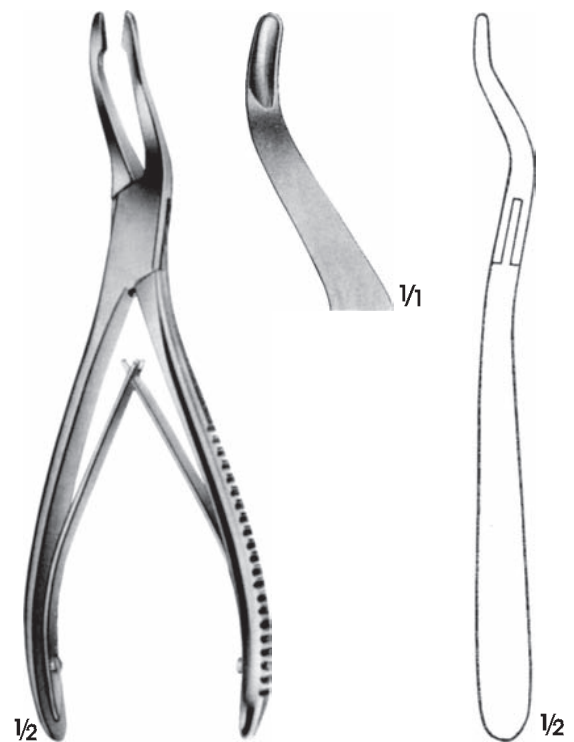

JANSEN
FO 282.00
19 cm



BEYER
FO 285.00
18 cm



LUER
FO 290.00-FO 291.00
17.5 cm



BANE-HARTMANN
FO 279.00
17.5 cm

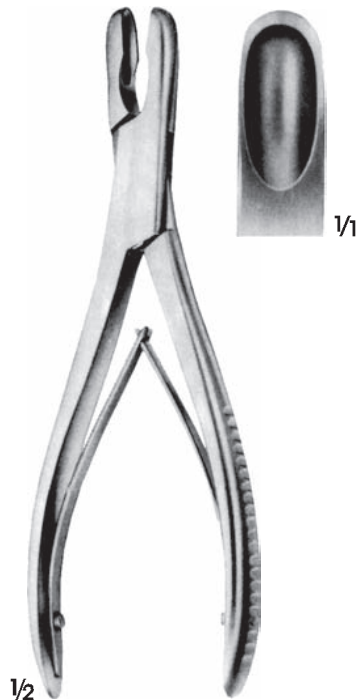

LUER
FO 295.00
18 cm



LUER
FO 296.00
18 cm

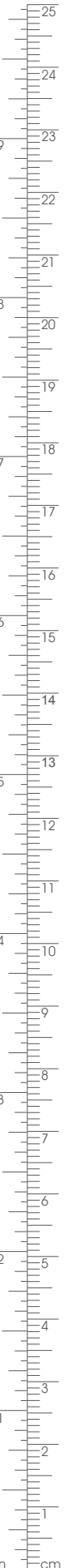

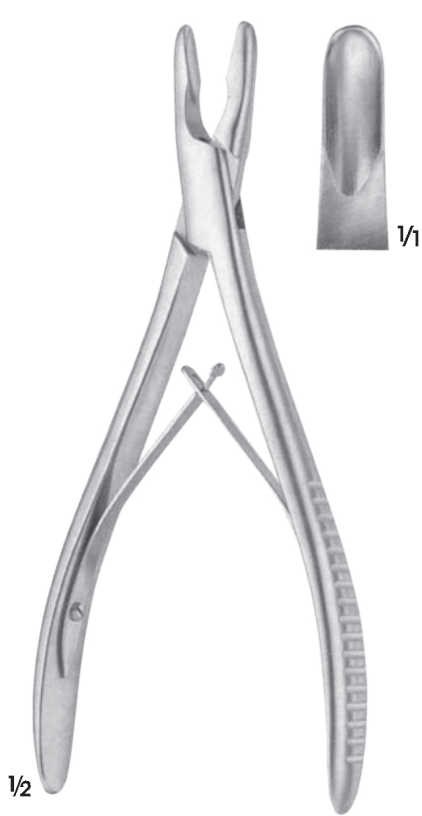

1/2
ADSON
FO 323.01
20 cm



1/2
NORTHFIELD
FO 329.01
21 cm

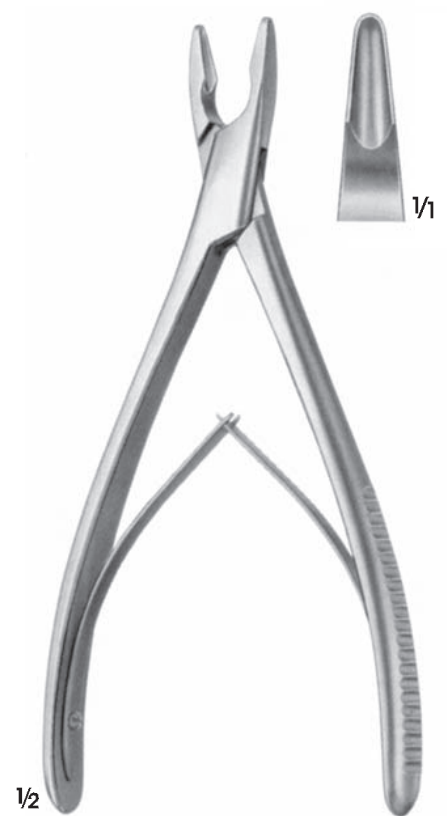

1/2
PENNYBACKER
FO 327.01
20.5 cm



1/2
TROTTER
FO 299.00
20.5 cm

Yana eğri
Curved to side



1/2
GULEKE
FO 298.00
20.5 cm

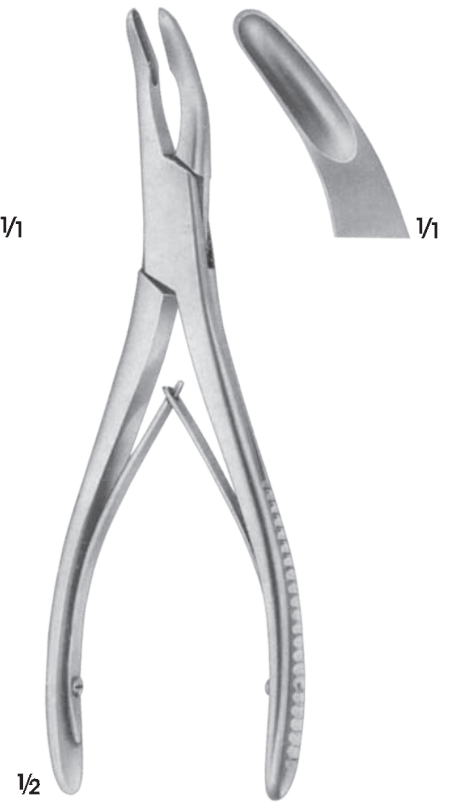

1/2
OLIVECRONA
FO 297.00
20.5 cm



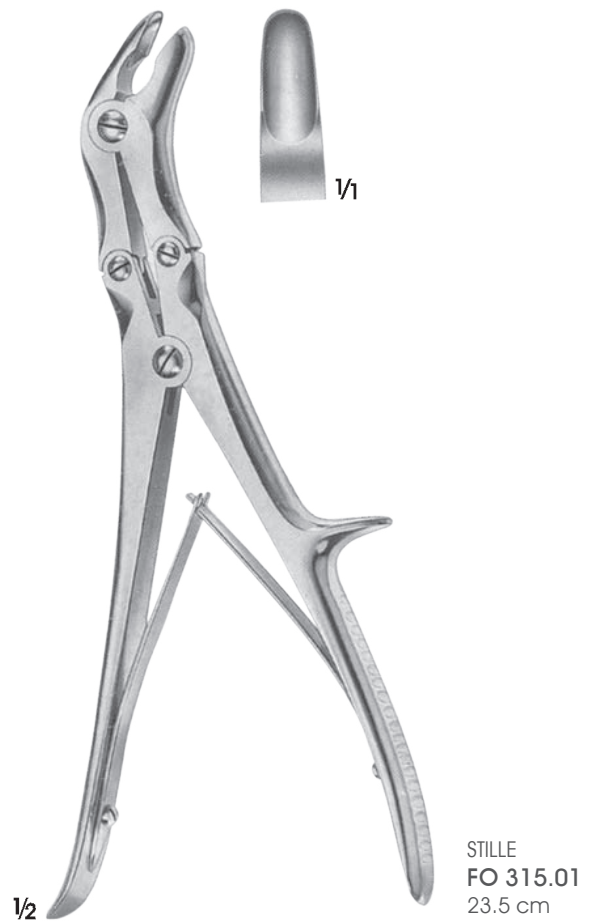
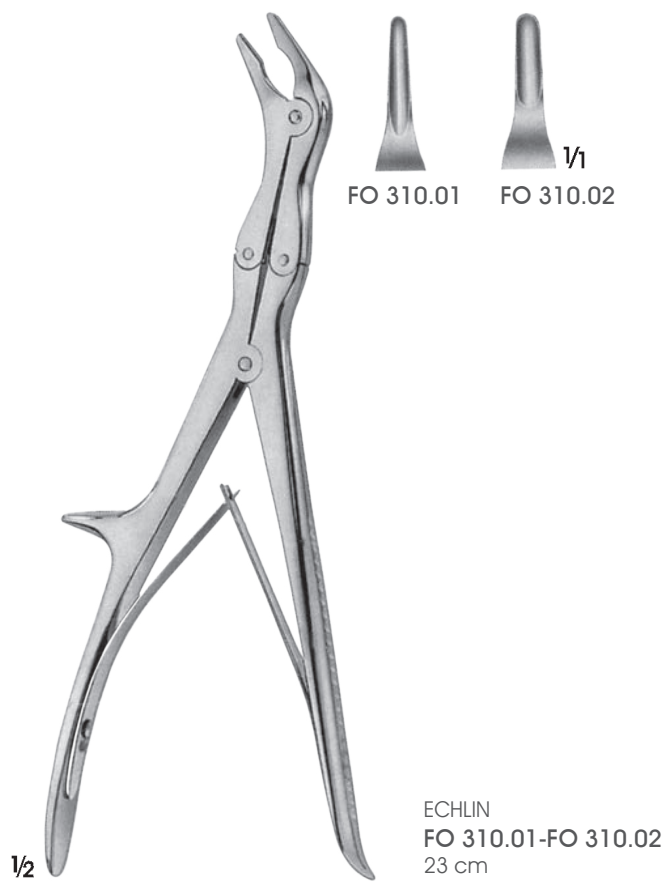



LEKSELL-STILLE
FO 316.01
24 cm



STILLE-RUSKIN
FO 318.01
24 cm



LUER-STILLE
FO 320.01
22.5 cm



LUER-STILLE
FO 321.01
22.5 cm

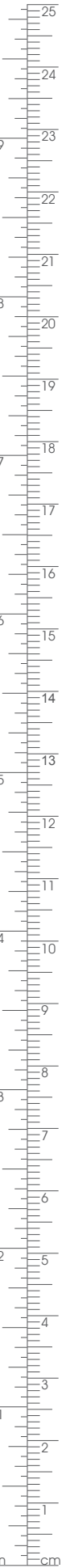



SEMB
FO 325.01
24 cm



LUER-STILLE
FO 326.01
27 cm



SAUERBRUCH-CORYLLOS
FO 333.01-FO 335.01
31 cm



SYPERT
FG 338.02
36 cm

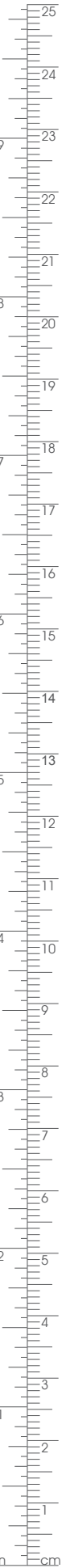

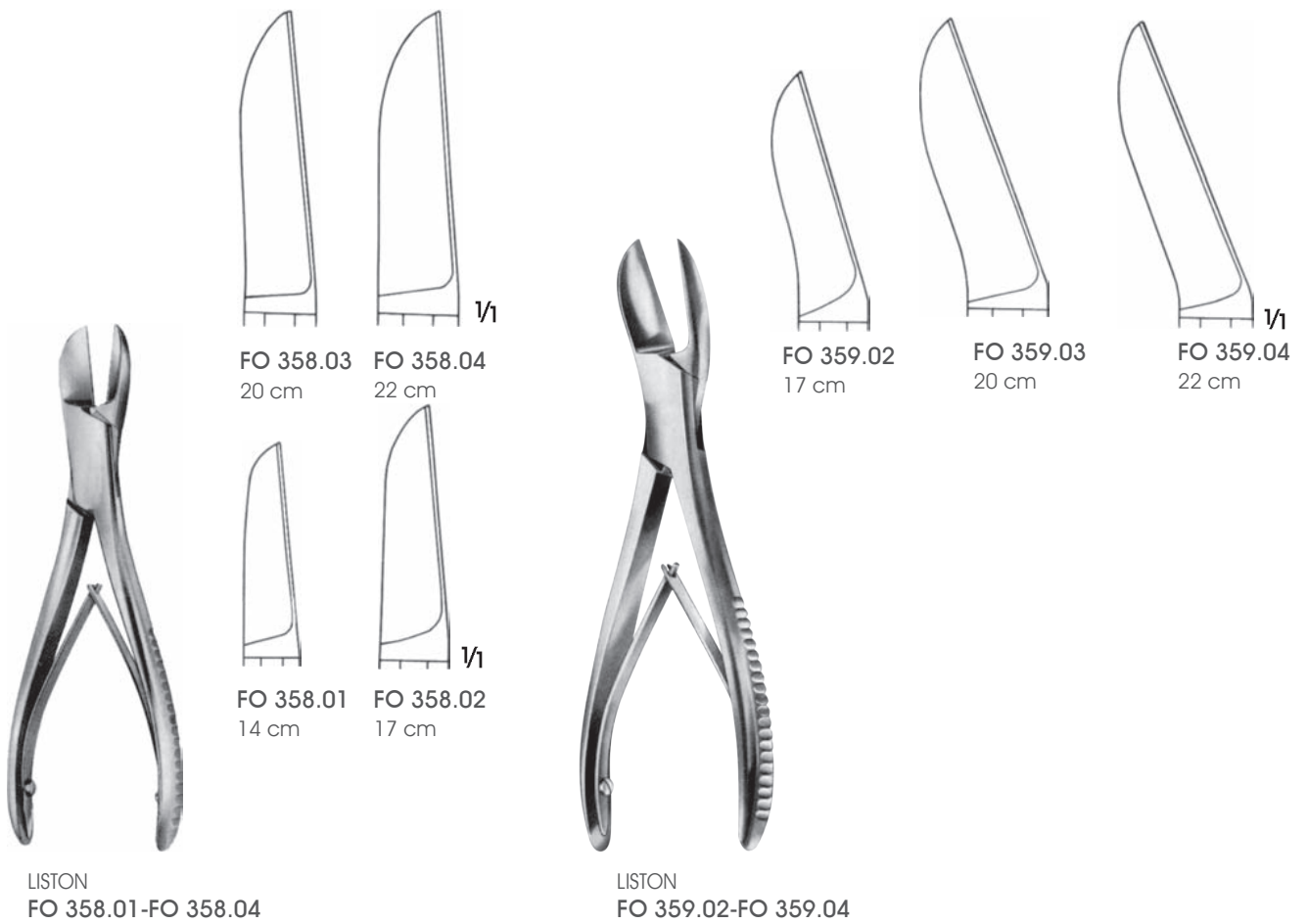
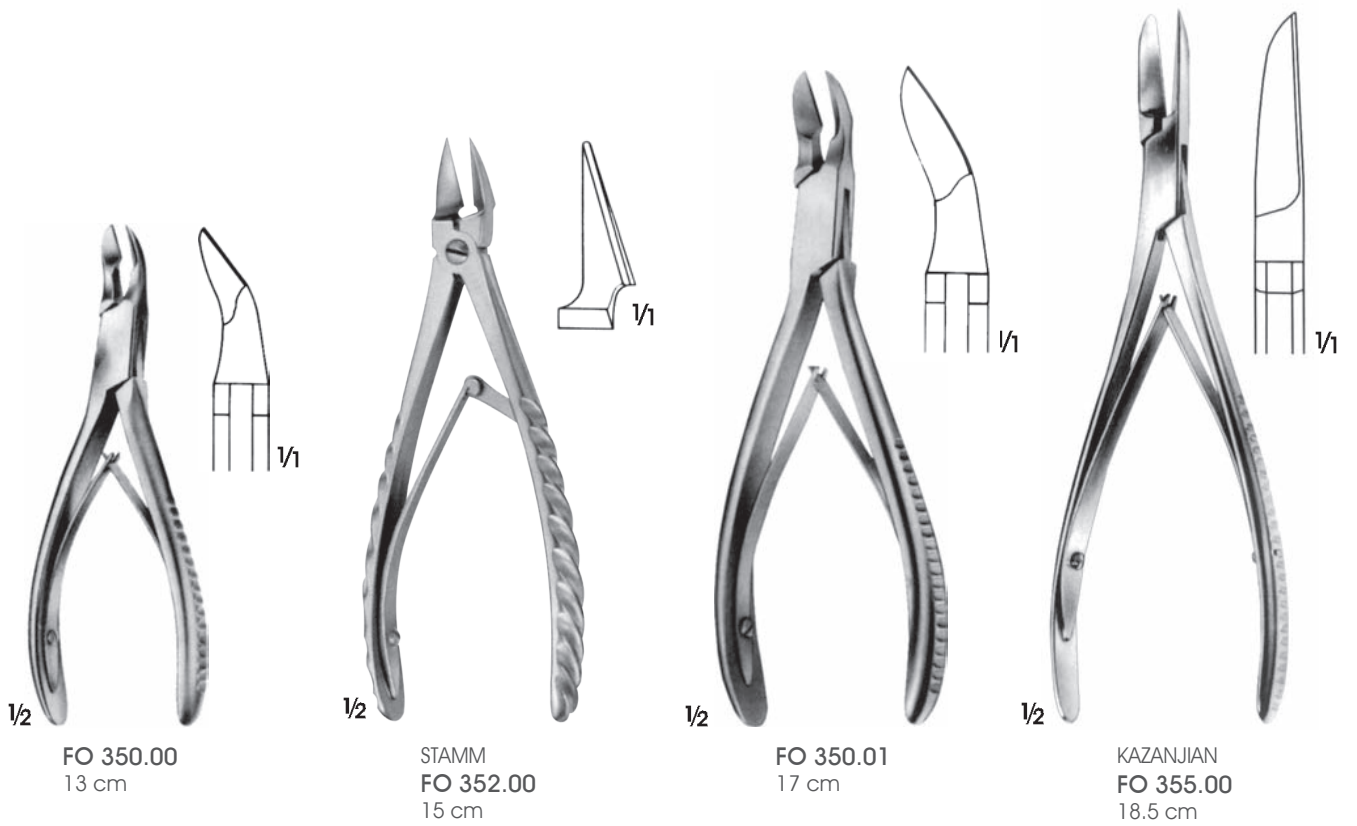



BÖHLER
FO 365.00
14.5 cm



BÖHLER
FO 366.00
14.5 cm



FO 367.00
17 cm



MC INDOE
FO 368.00
17.5 cm



RUSKIN-LISTON
FO 370.00
19 cm



RUSKIN-LISTON
FO 371.00
19 cm

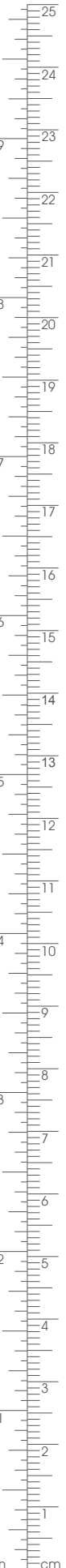

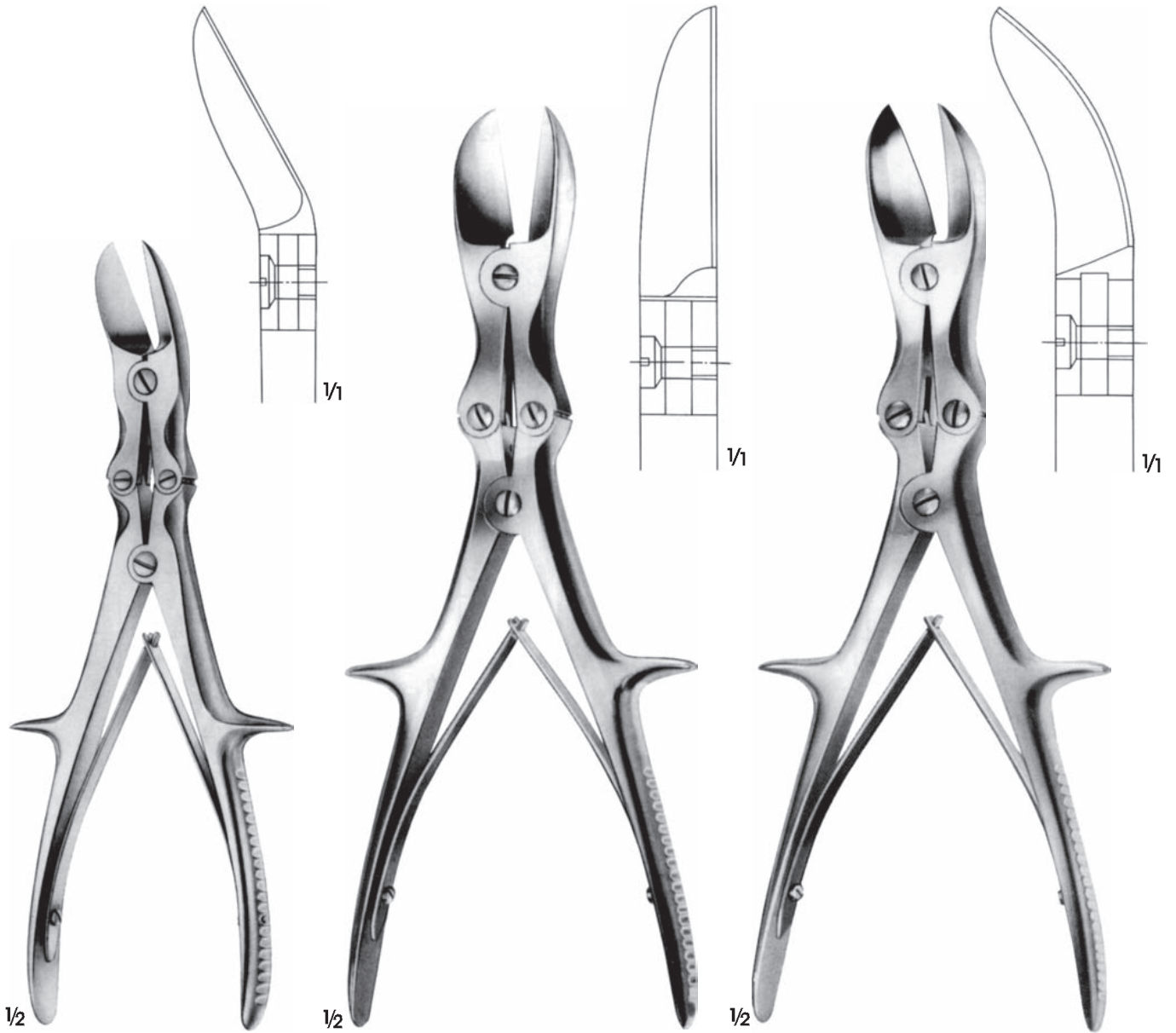

LISTON
FO 375.01
Düz eğimli/Curved on flat
24 cm

LISTON
FO 376.01
Düz/Straight
28 cm

LISTON
FO 377.01
Düz eğimli/Curved on flat
28 cm

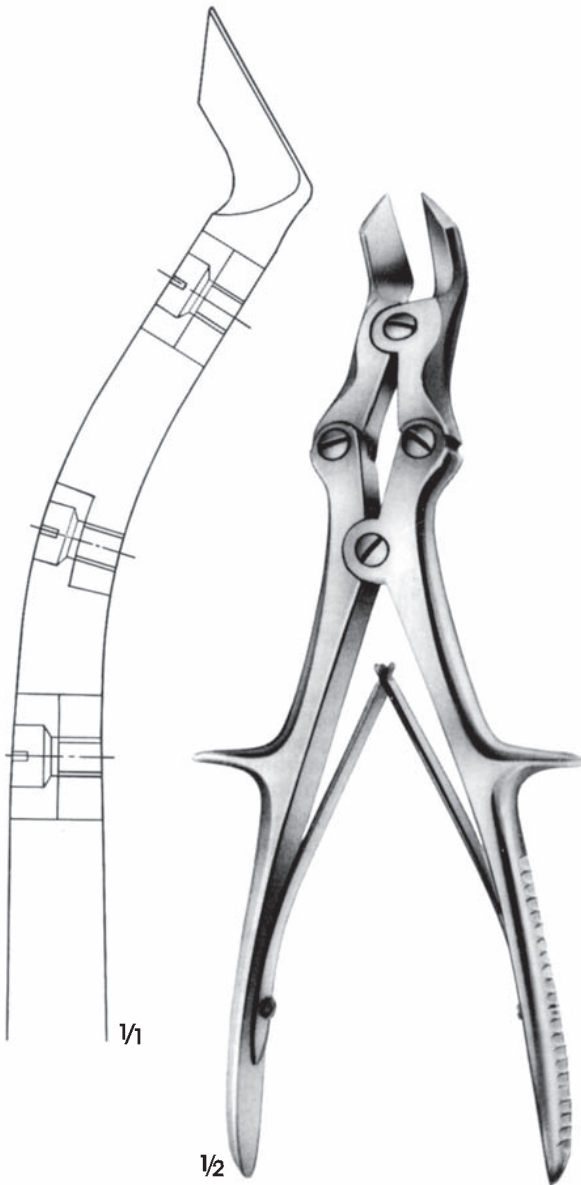
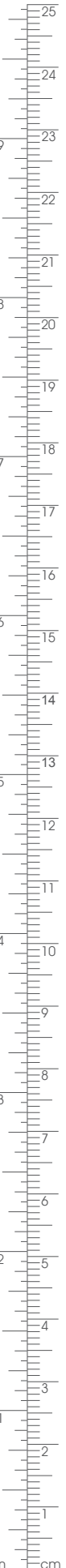

LISTON-KEY-HORSLEY
FO 379.01
25.5 cm

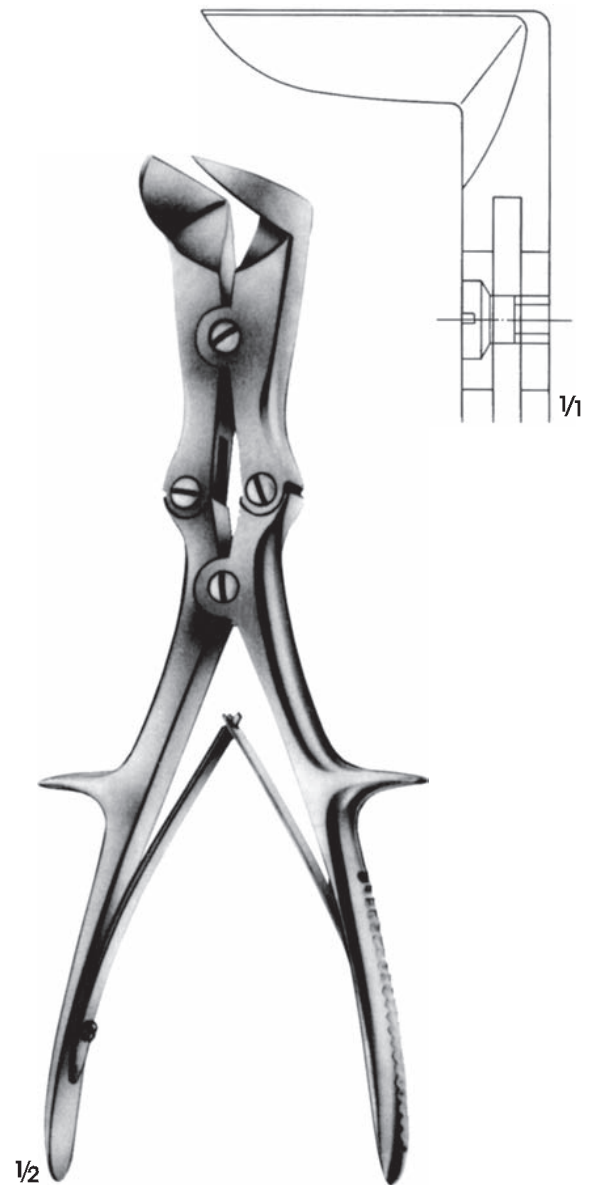

LISTON-STILLE
FO 378.01
26.5 cm

Pançlar için açılı pozisyonlar
Angled positions for punches

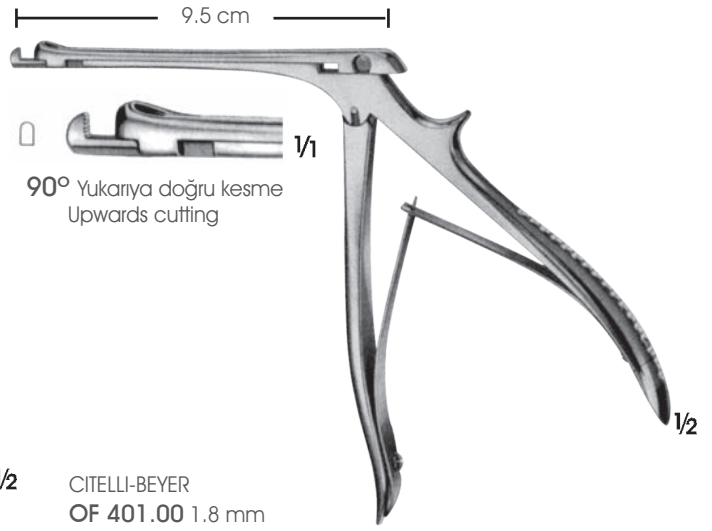
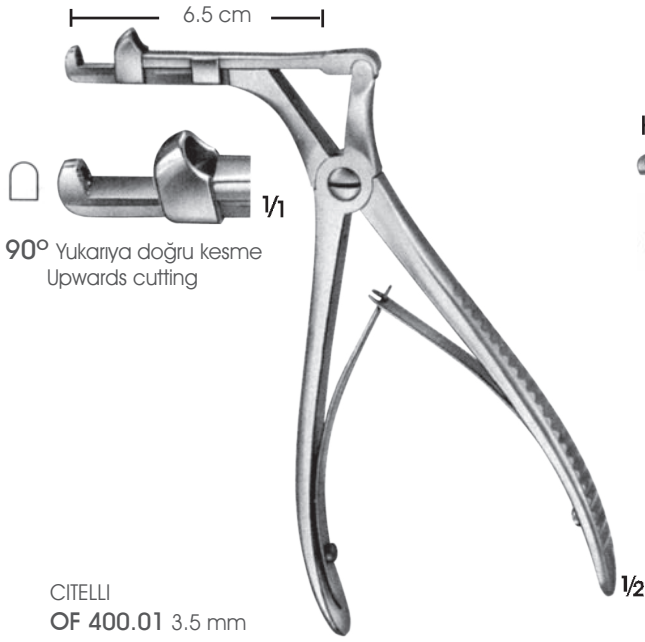
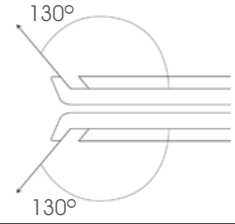
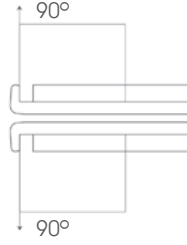
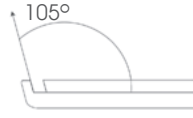

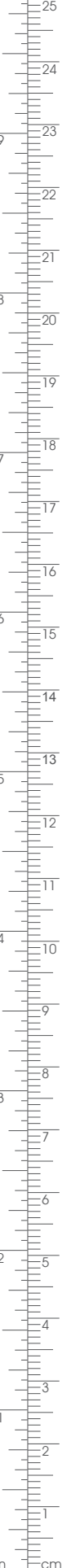
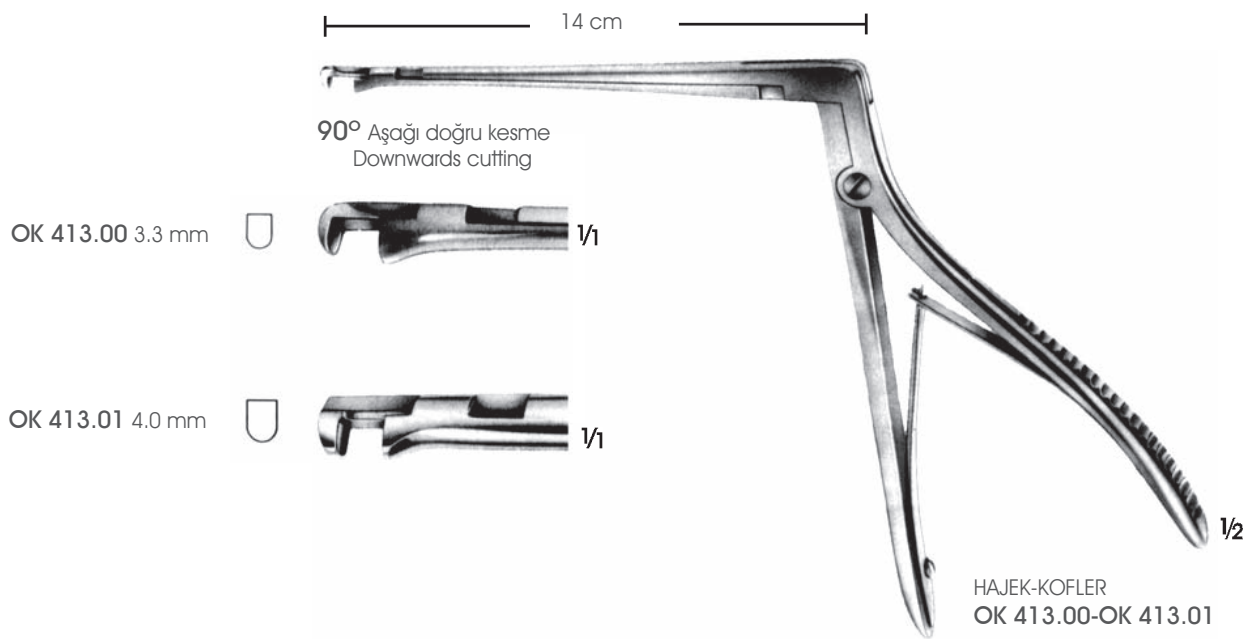
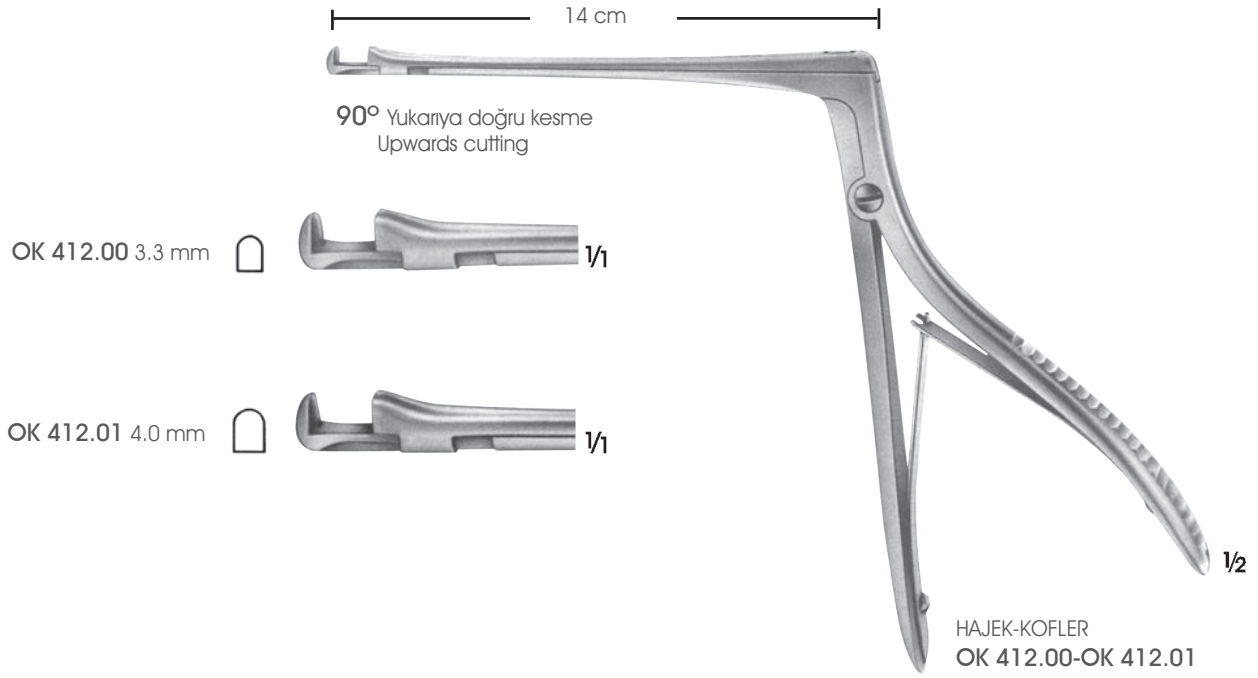

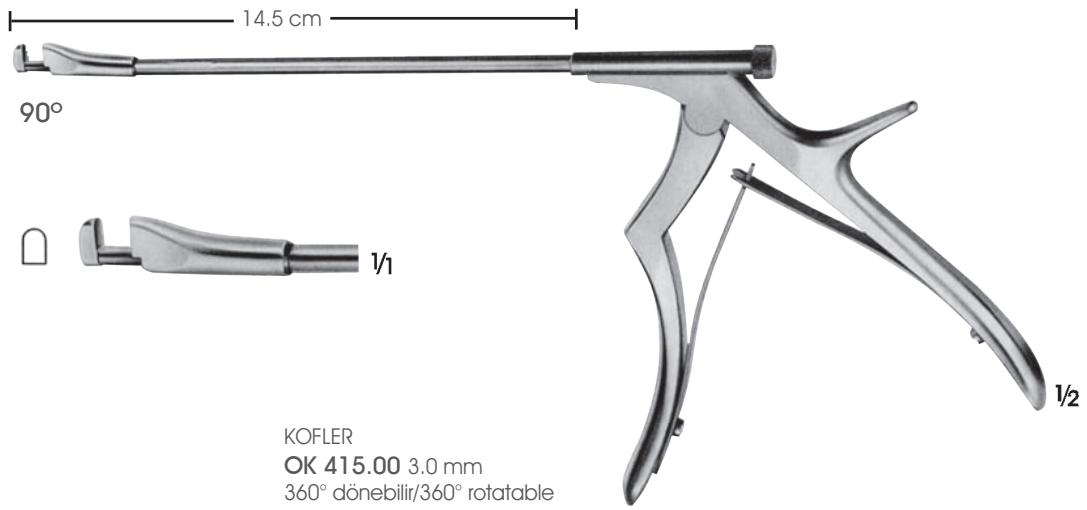
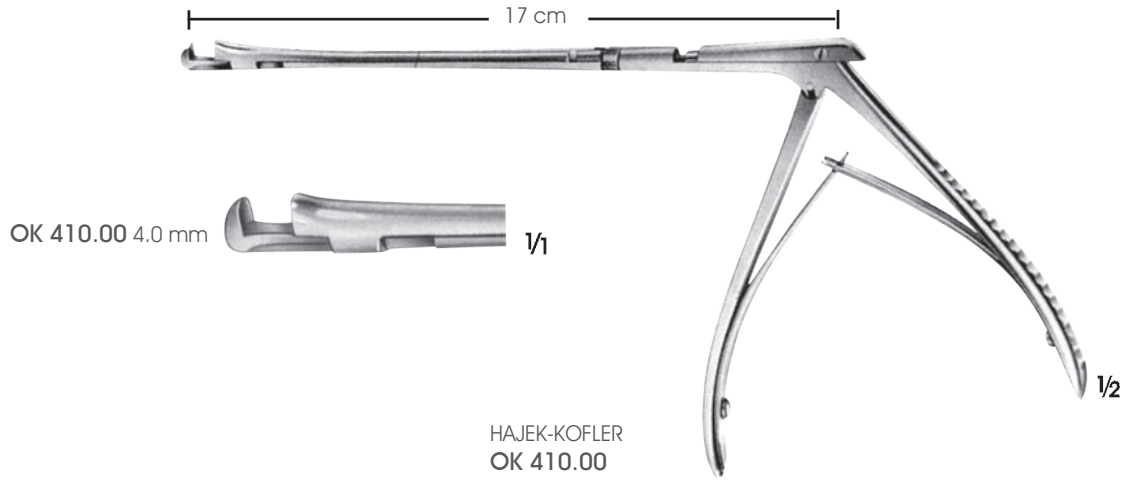

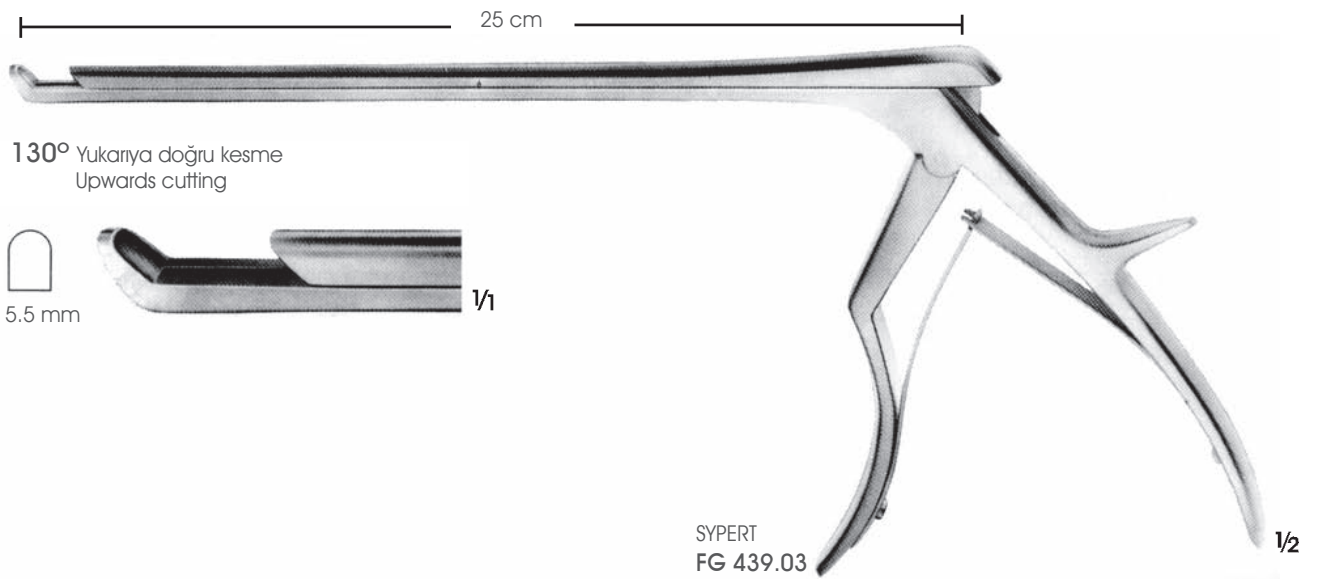
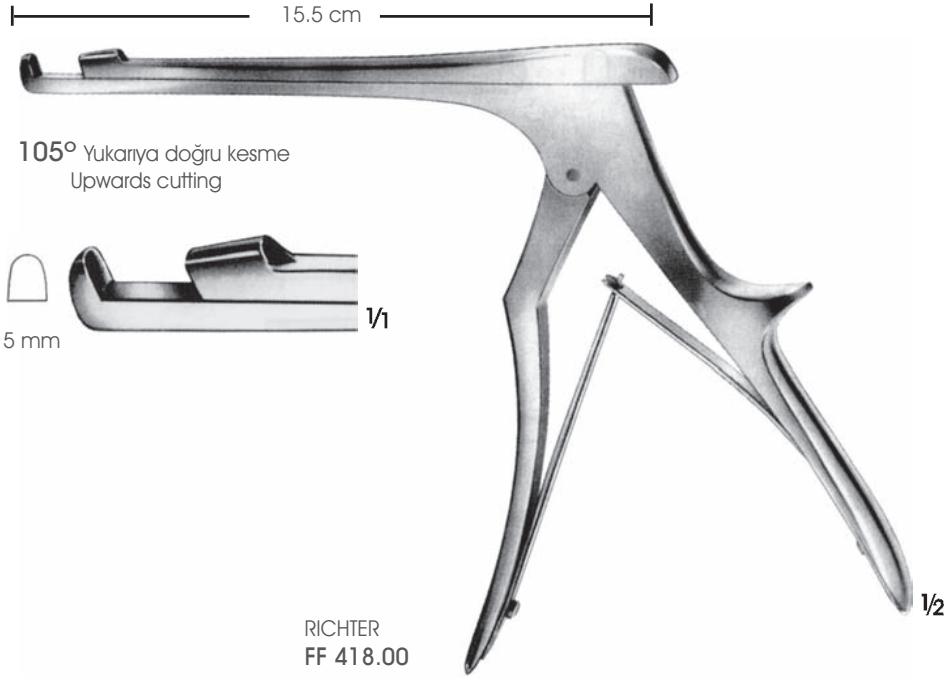

130° Yukarıya doğru kesme/Upwards cutting



Standart ağız tabanlı
Standard footplate



Ince ağız tabanlı
With thin footplate

HARDCOATED



Standart ağız tabanlı
Standard footplate

HARDCOATED



Ince ağız tabanlı
With thin footplate

Ayrılabilir/Detachable

Boy Length	En Width	Ejektör Ejector	Ayrılabilir/Detachable				
18 cm	1 mm	-		FK 709.01	FK 750.01	FK 709.01B	FK 750.01B
18 cm	2 mm	-		FK 709.02	FK 750.02	FK 709.02B	FK 750.02B
18 cm	3 mm	+		FK 709.03	FK 750.03	FK 709.03B	FK 750.03B
18 cm	4 mm	+		FK 709.04	FK 750.04	FK 709.04B	FK 750.04B
18 cm	5 mm	+		FK 709.05	FK 750.05	FK 709.05B	FK 750.05B
18 cm	6 mm	+		FK 709.06	-	FK 709.06B	-
20 cm	1 mm	-	-	-	FK 752.01	-	FK 752.01B
20 cm	2 mm	-		FK 710.02	FK 752.02	FK 710.02B	FK 752.02B
20 cm	3 mm	+		FK 710.03	FK 752.03	FK 710.03B	FK 752.03B
20 cm	4 mm	+		FK 710.04	FK 752.04	FK 710.04B	FK 752.04B
20 cm	5 mm	+		FK 710.05	FK 752.05	FK 710.05B	FK 752.05B
20 cm	6 mm	+		FK 710.06	-	FK 710.06B	-
23 cm	2 mm	-		FK 712.02	FK 754.02	FK 712.02B	FK 754.02B
23 cm	3 mm	+		FK 712.03	FK 754.03	FK 712.03B	FK 754.03B
23 cm	4 mm	+		FK 712.04	FK 754.04	FK 712.04B	FK 754.04B
23 cm	5 mm	+		FK 712.05	FK 754.05	FK 712.05B	FK 754.05B

90° Yukarıya doğru kesme/Upwards cutting



Standart ağız tabanlı
Standard footplate

HARDCOATED















Standart ağız tabanlı
Standard footplate



Standart ağız tabanlı
Standard footplate

Boy Length	En Widht	Ejektör Ejector	Ayrılabilir/Detachable		Standart/Standard		
							
18 cm	1 mm		-	FK 701.01	FK 701.01B	FF 431.00	
18 cm	2 mm		-	FK 701.02	FK 701.02B	FF 431.01	
18 cm	3 mm		+	FK 701.03	FK 701.03B	FF 431.02	
18 cm	4 mm		+	FK 701.04	FK 701.04B	FF 431.03	
18 cm	5 mm		+	FK 701.05	FK 701.05B	FF 431.04	
18 cm	6 mm		+	FK 701.06	FK 701.06B	FF 431.05	
23 cm	2 mm		-	FK 703.02			
23 cm	3 mm		+	FK 703.03			
23 cm	4 mm		+	FK 703.04			
23 cm	5 mm		+	FK 703.05			

90° Aşağıya doğru kesme/Downwards cutting

Boy Length	En Widht	Ejektör Ejector	Ayrılabilir/Detachable		Standart/Standard		
							
18 cm	1 mm		-	FK 705.01		FF 433.00	
18 cm	2 mm		-	FK 705.02		FF 433.01	
18 cm	3 mm		+	FK 705.03		FF 433.02	
18 cm	4 mm		+	FK 705.04		FF 433.03	
18 cm	5 mm		+	FK 705.05		FF 433.04	
18 cm	6 mm		+	FK 705.06		FF 433.05	
23 cm	2 mm		-	FK 707.02			
23 cm	3 mm		+	FK 707.03			
23 cm	4 mm		+	FK 707.04			
23 cm	5 mm		+	FK 707.05			

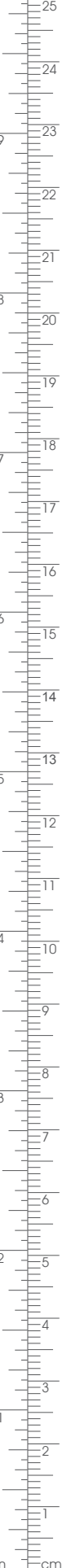

130° Aşağıya doğru kesme/Downwards cutting



Standart ağız tabanlı
Standard footplate



Ince ağız tabanlı
With thin footplate



Standart ağız tabanlı
Standard footplate



Ince ağız tabanlı
With thin footplate

Ayrılabilir/Detachable

Standart/Standard

Boy
Length

En
Width

Ejektör
Ejector



18 cm

1 mm

□

-

FK 714.01

FK 757.01

FF 432.00

FF 435.00

18 cm

2 mm

□

-

FK 714.02

FK 757.02

FF 432.01

FF 435.01

18 cm

3 mm

□

+

FK 714.03

FK 757.03

FF 432.02

FF 435.02

18 cm

4 mm

□

+

FK 714.04

FK 757.04

FF 432.03

FF 435.03

18 cm

5 mm

□

+

FK 714.05

FK 757.05

FF 432.04

FF 435.04

21.5 cm

2 mm

□

-

FF 437.01

21.5 cm

3 mm

□

-

FF 437.02

21.5 cm

4 mm

□

+

FF 437.03

21.5 cm

5 mm

□

+

FF 437.04

23 cm

2 mm

□

-

FK 717.02

FF 453.02

23 cm

3 mm

□

+

FK 717.03

FF 453.03

23 cm

4 mm

□

+

FK 717.04

FF 453.04

23 cm

5 mm

□

+

FK 717.05

FF 453.05

130° Yukarıya doğru kesme/Upwards cutting























Standart ağız tabanlı
Standard footplate



Ince ağız tabanlı
With thin footplate

Standart/Standard

Boy Length	En Width			
18 cm	1 mm		FF 430.00	FF 434.00
18 cm	2 mm		FF 430.01	FF 434.01
18 cm	3 mm		FF 430.02	FF 434.02
18 cm	4 mm		FF 430.03	FF 434.03
18 cm	5 mm		FF 430.04	FF 434.04
18 cm	6 mm		FF 430.05	-
20 cm	1 mm		-	FF 441.01
20 cm	2 mm		FF 438.01	FF 441.02
20 cm	3 mm		FF 438.02	FF 441.03
20 cm	4 mm		FF 438.03	FF 441.04
20 cm	5 mm		FF 438.04	FF 441.05
20 cm	6 mm		FF 438.05	-
21.5 cm	2 mm		FF 436.01	
21.5 cm	3 mm		FF 436.02	
21.5 cm	4 mm		FF 436.03	
21.5 cm	5 mm		FF 436.04	
23 cm	2 mm		FF 452.02	FF 449.02
23 cm	3 mm		FF 452.03	FF 449.03
23 cm	4 mm		FF 452.04	FF 449.04
23 cm	5 mm		FF 452.05	FF 449.05



OK Ronjurlar
Rongeurs



 **ARGENT**

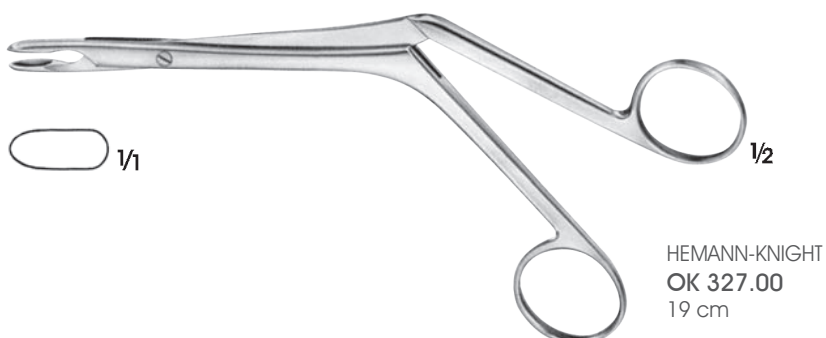
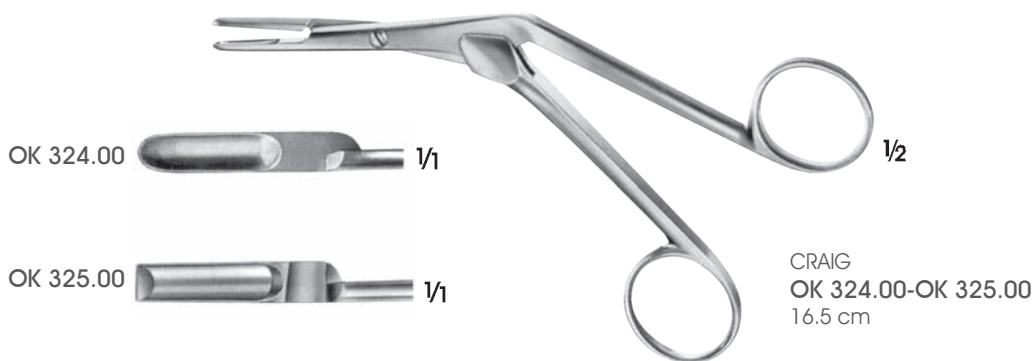
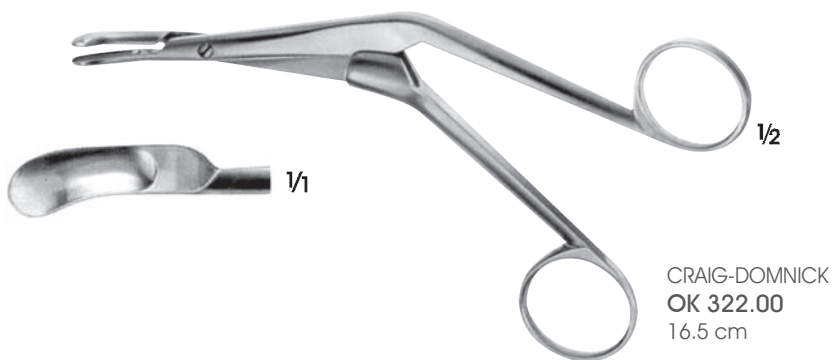

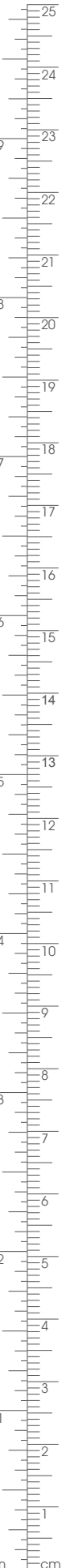
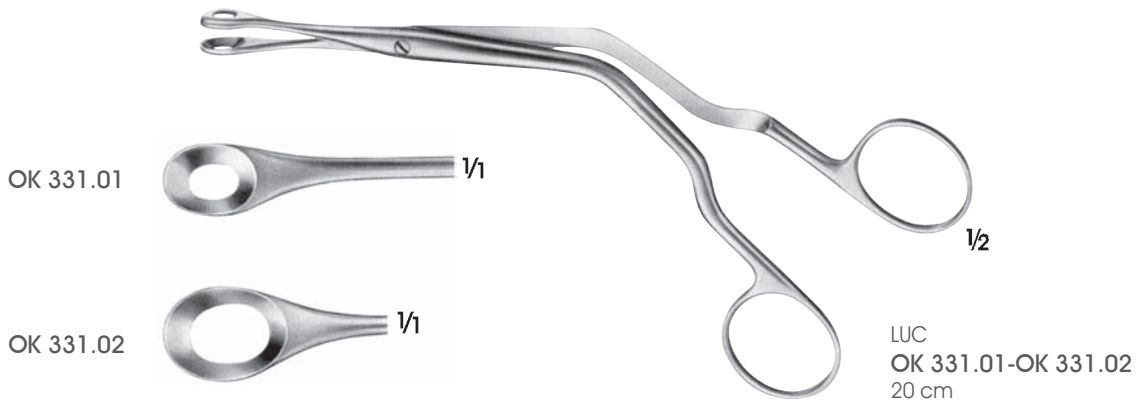
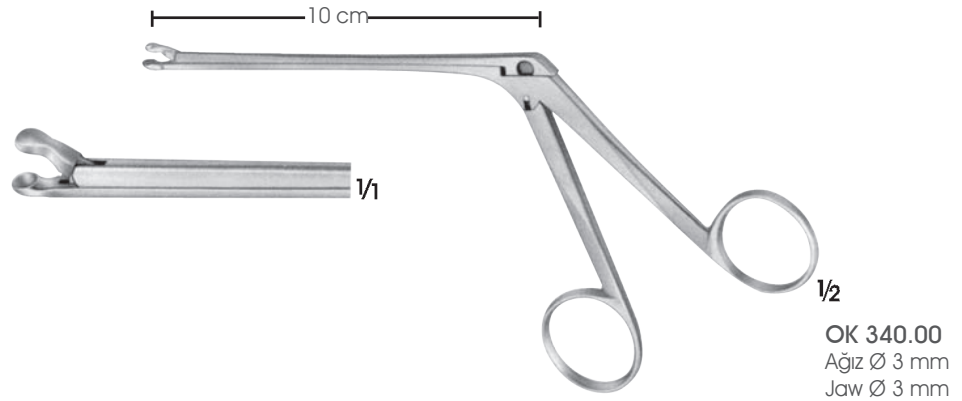

Pançlar için açılı pozisyonlar
Angled positions for punches

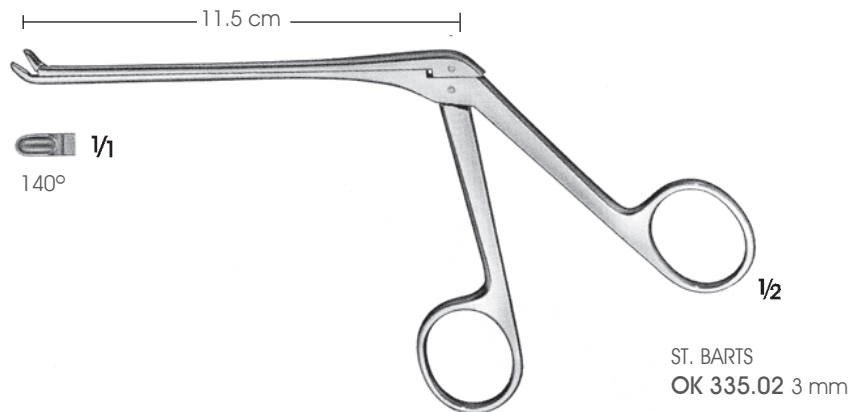
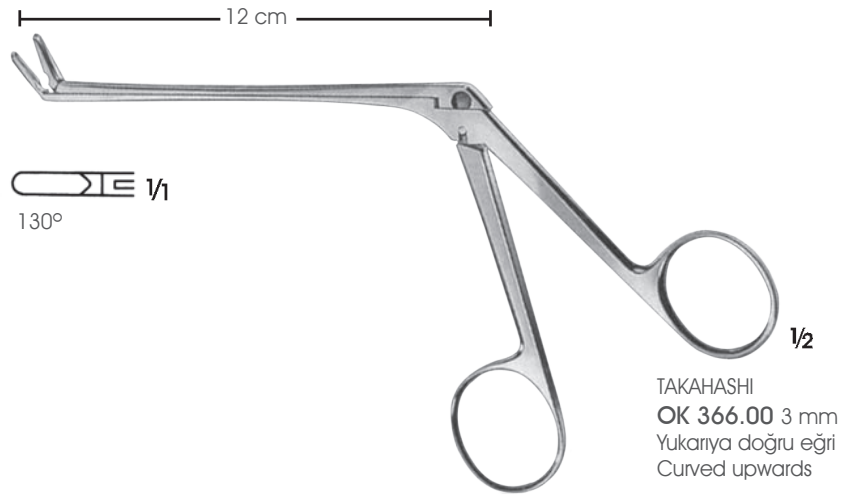
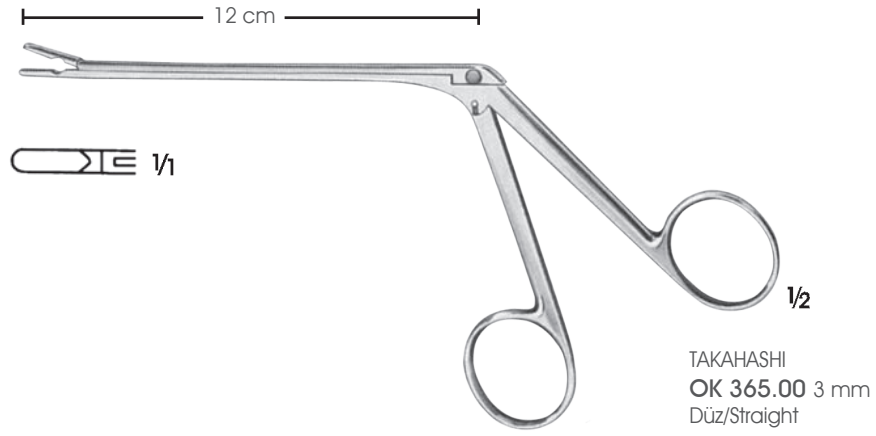
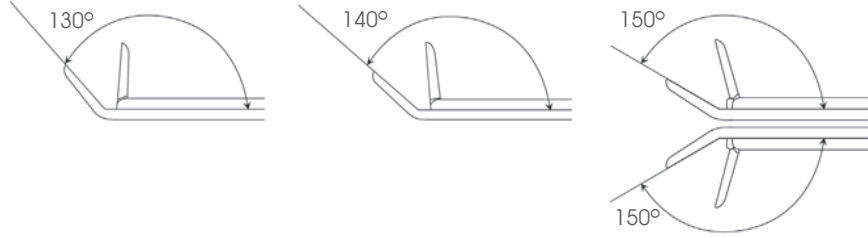

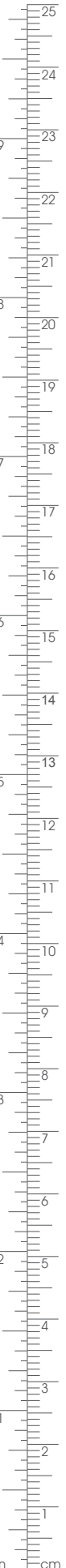
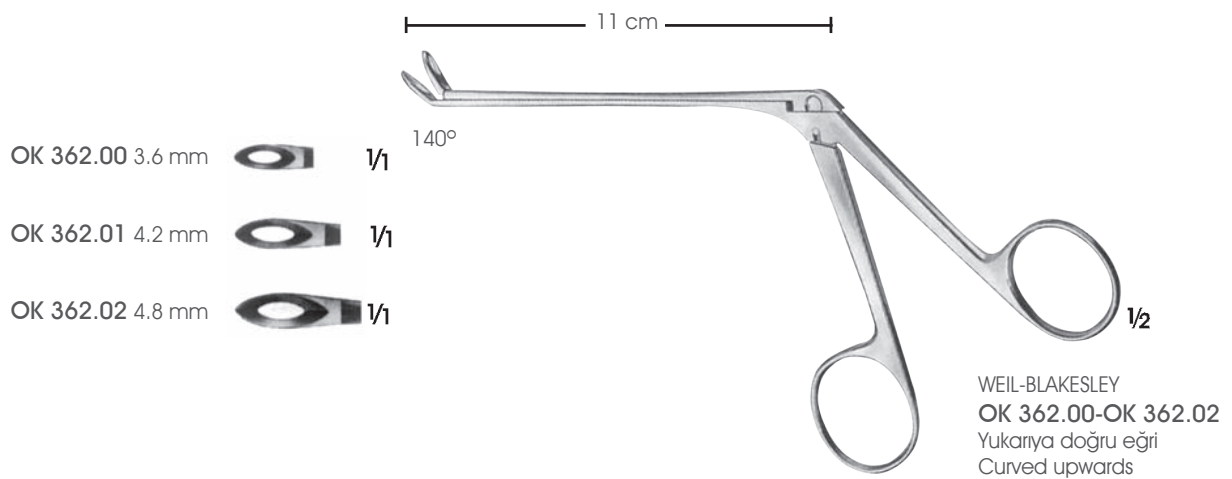
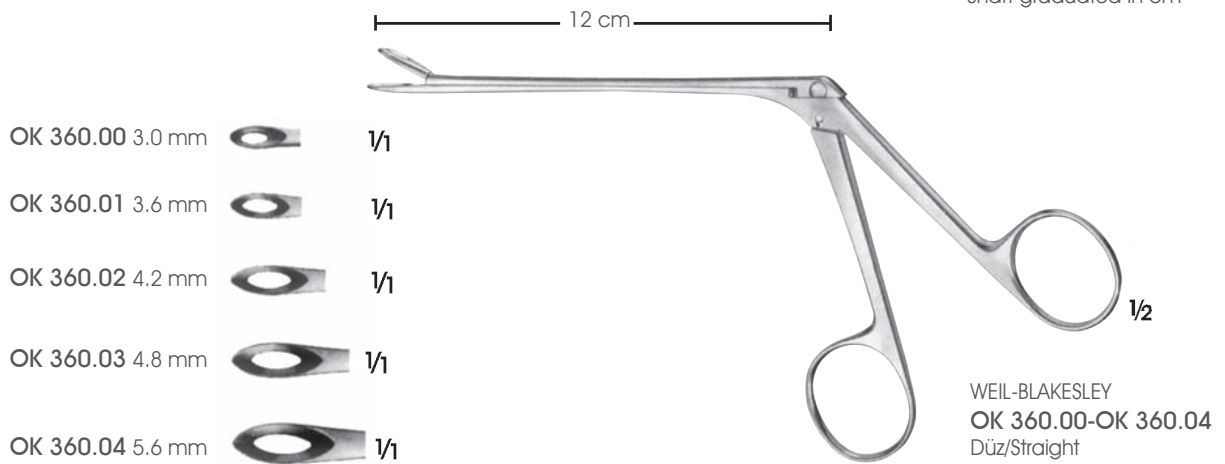
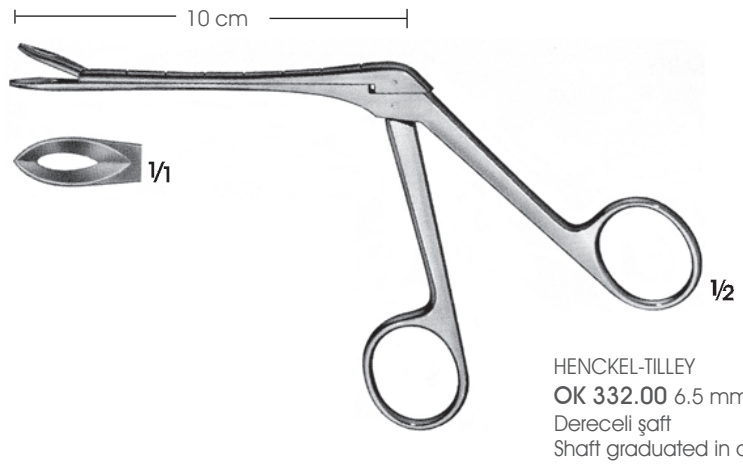

11.5 cm



ST. BARTS
OK 335.01 3 mm

13 cm



BECK
FF 420.01 2 mm

12.5 cm



PENNYBACKER
FF 428.01 3 mm

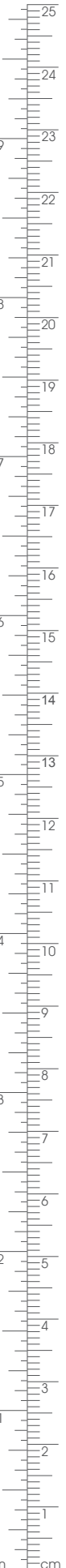
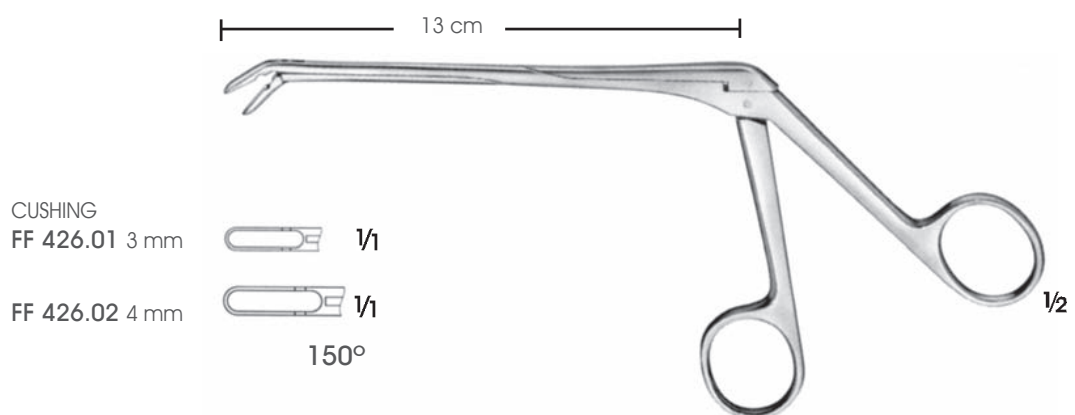
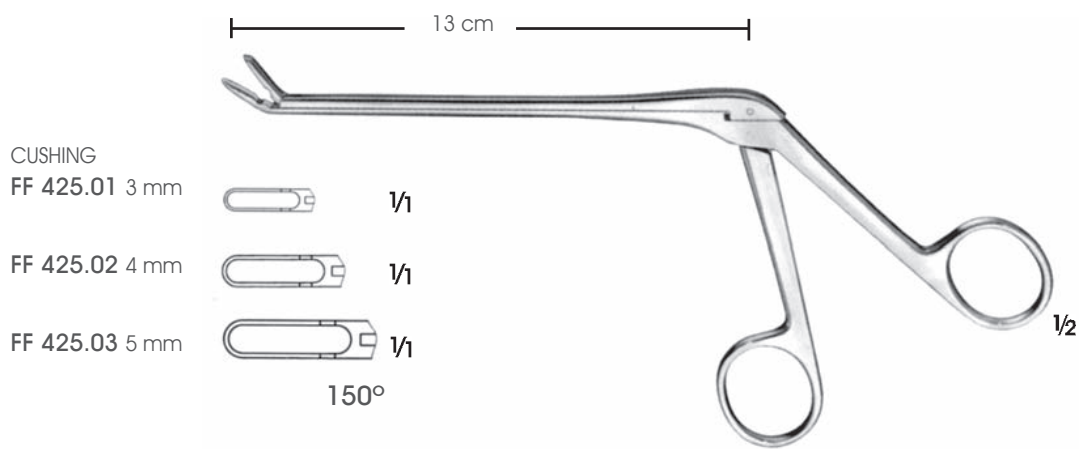
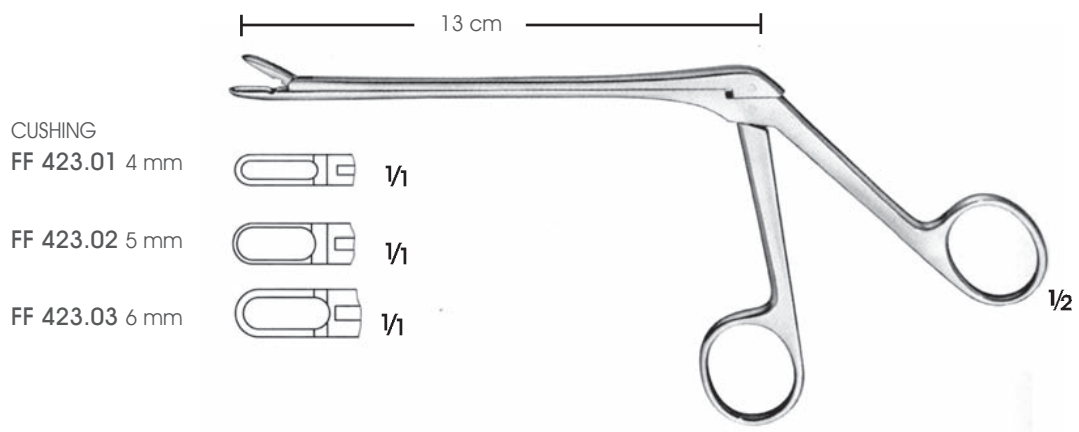

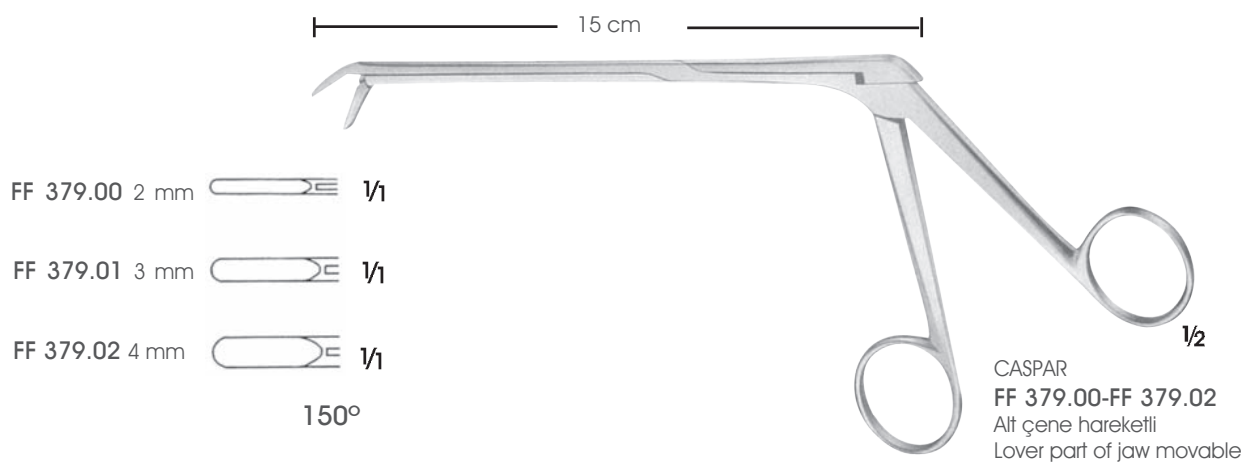
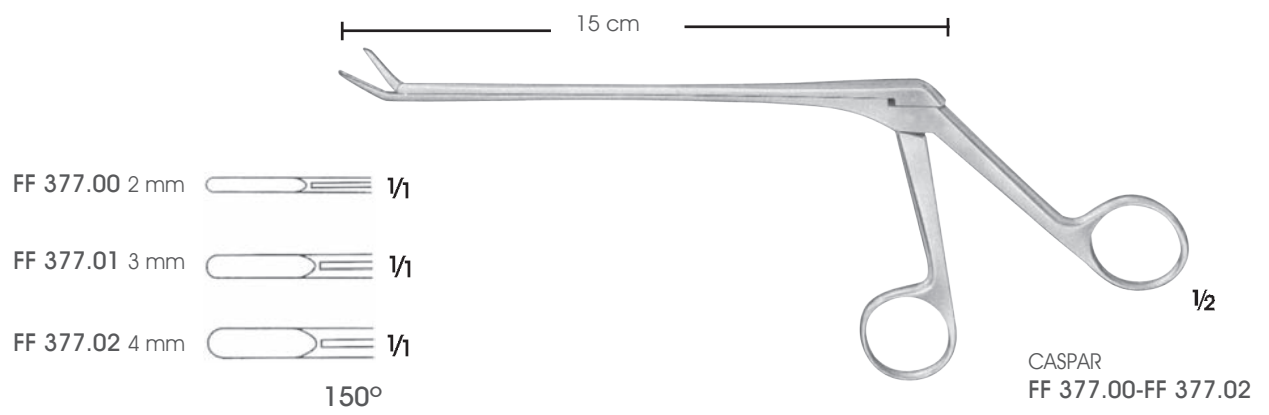
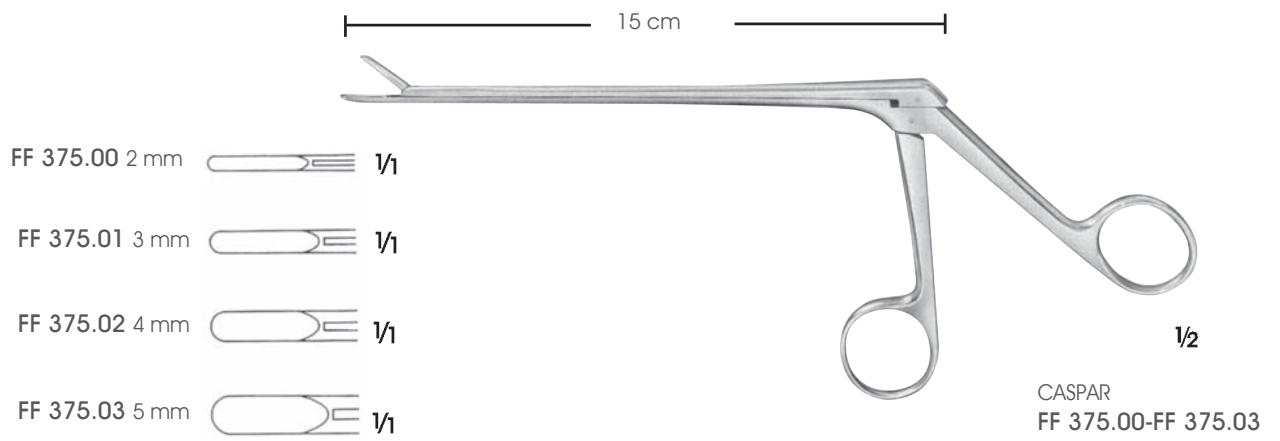

LOVE-GRUENWALD
FF 370.00
2 x 10 mm



1/1

LOVE-GRUENWALD
FF 370.01
3 x 10 mm



1/1

SPURLING
R 371.02
4 x 10 mm



1/1



CUSHING
FF 380.00
2 x 10 mm

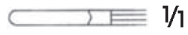

1/1

LOVE-GRUENWALD
FF 383.01
3 x 10 mm



1/1

SPURLING
FF 386.02
4 x 10 mm



1/1



LOVE-GRUENWALD
FF 384.01
3 x 10 mm



1/1

SPURLING
R 387.02
4 x 10 mm



1/1



Üst çene hareketli
Upper part of jaw movable

LOVE-GRUENWALD
FF 385.01
3 x 10 mm

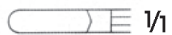

1/1

LOVE-GRUENWALD
FF 388.02
4 x 10 mm



150°

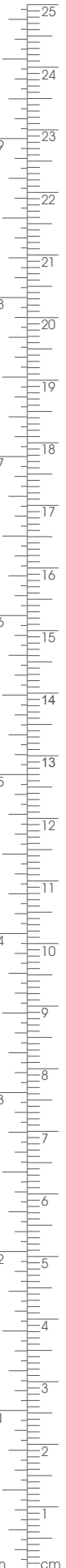
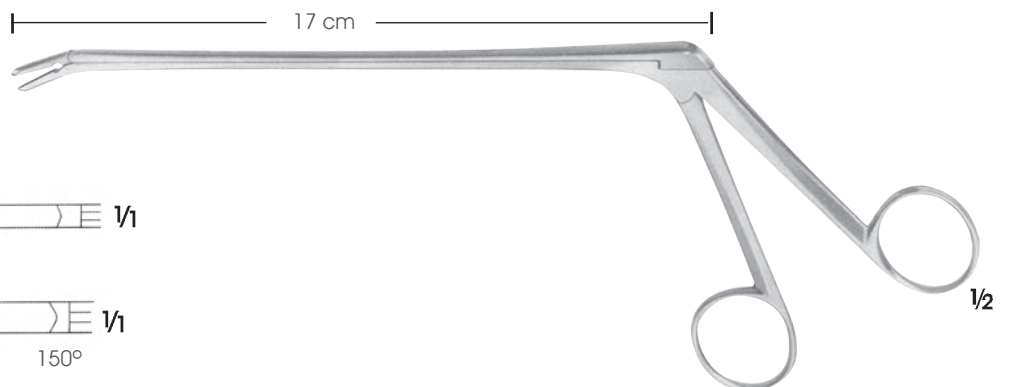

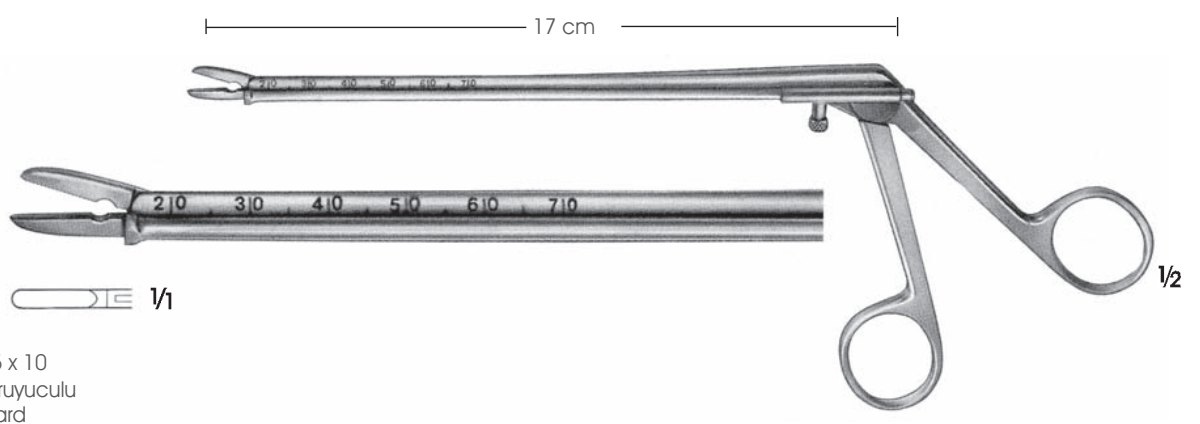
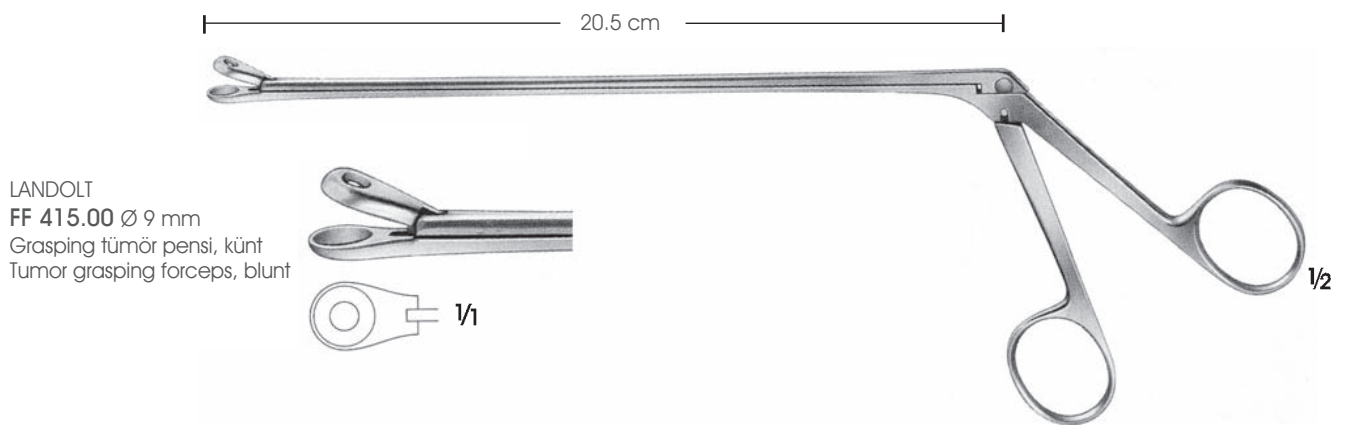
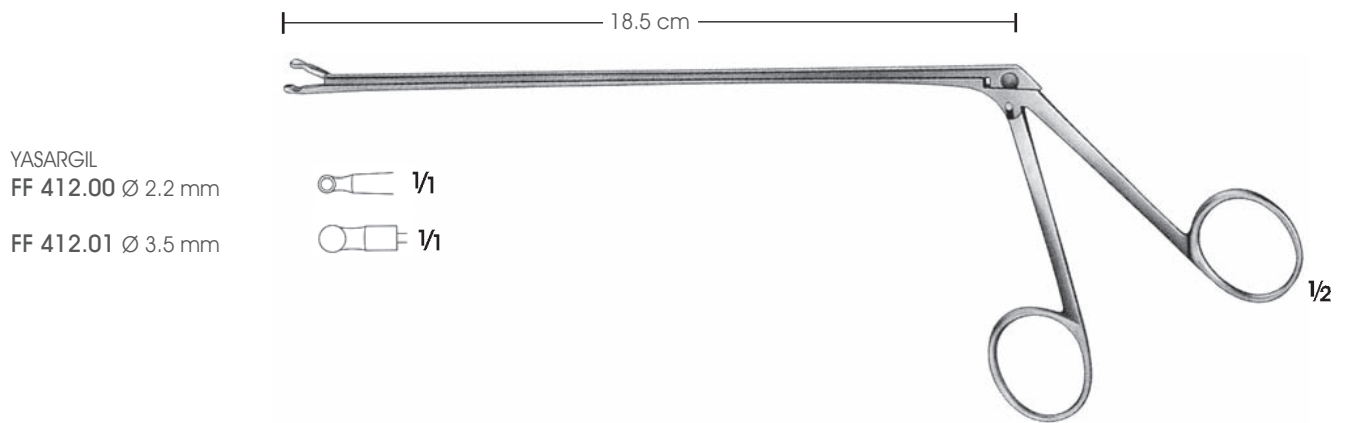
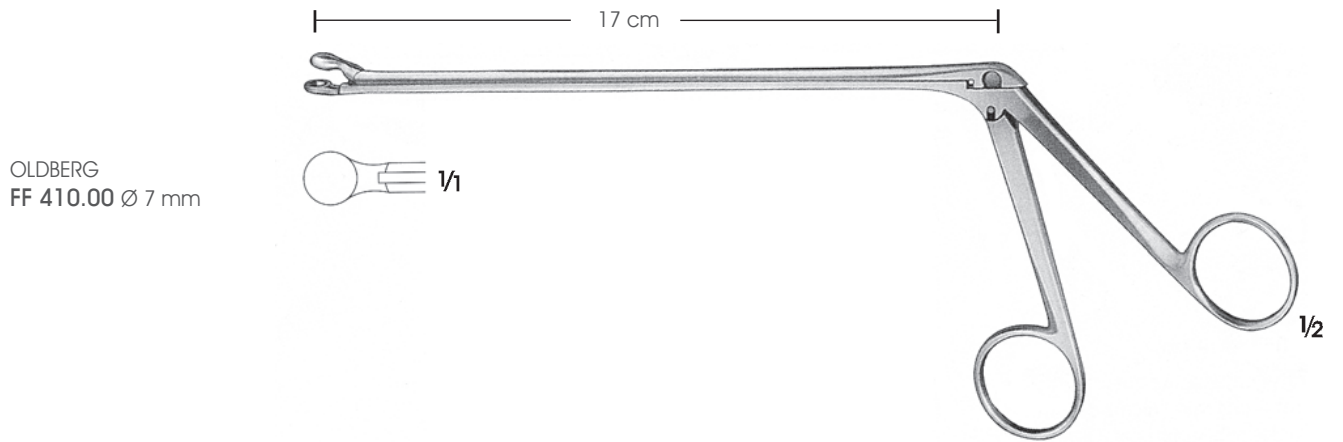

Alt çene hareketli
Upper part of jaw movable

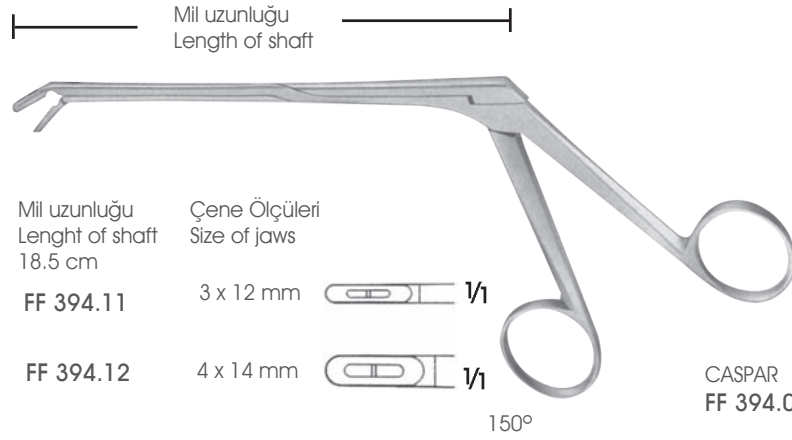

Mil uzunluğu Length of shaft 14 cm	Mil uzunluğu Length of shaft 16 cm	Mil uzunluğu Length of shaft 18.5 cm	Çene Ölçüleri Size of jaws
FF 394.01	FF 394.06	FF 394.11	3 x 12 mm
FF 394.02	FF 394.07	FF 394.12	4 x 14 mm



CASPAR
FF 394.01-FF 394.12

Mil uzunluğu Length of shaft 14 cm	Mil uzunluğu Length of shaft 16 cm	Mil uzunluğu Length of shaft 18.5 cm	Çene ölçüleri Size of jaws
FF 390.00	FF 390.05	FF 390.10	2 x 12 mm
FF 390.01	FF 390.06	FF 390.11	3 x 12 mm
FF 390.02	FF 390.07	FF 390.12	4 x 14 mm
FF 390.03	FF 390.08	FF 390.13	5 x 14 mm
FF 390.04	FF 390.09	FF 390.14	6 x 16 mm

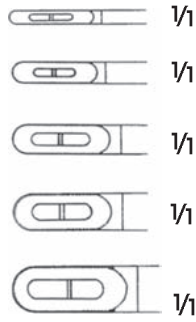
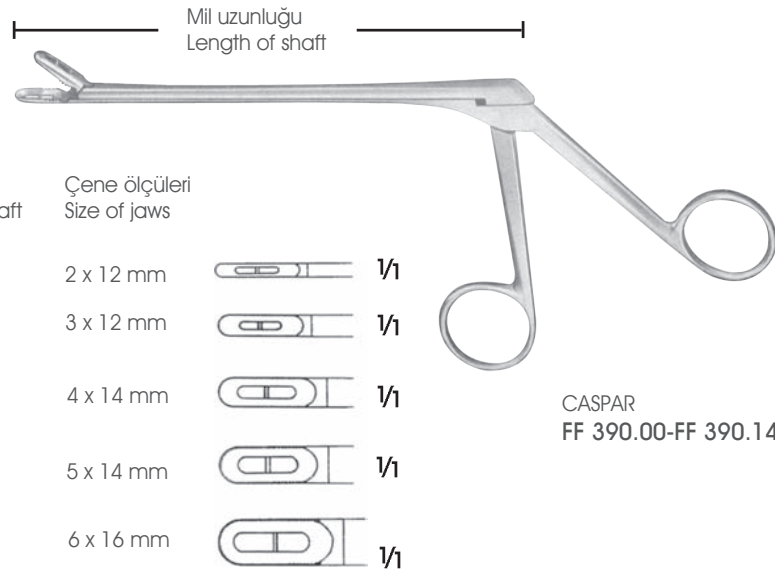

CASPAR
FF 390.00-FF 390.14

Mil uzunluğu Length of shaft 14 cm	Mil uzunluğu Length of shaft 16 cm	Mil uzunluğu Length of shaft 18.5 cm	Çene ölçüleri Size of jaws
FF 392.01	FF 392.06	FF 392.11	3 x 12 mm
FF 392.02	FF 392.07	FF 392.12	4 x 14 mm
FF 392.03	FF 392.08	FF 392.13	5 x 14 mm

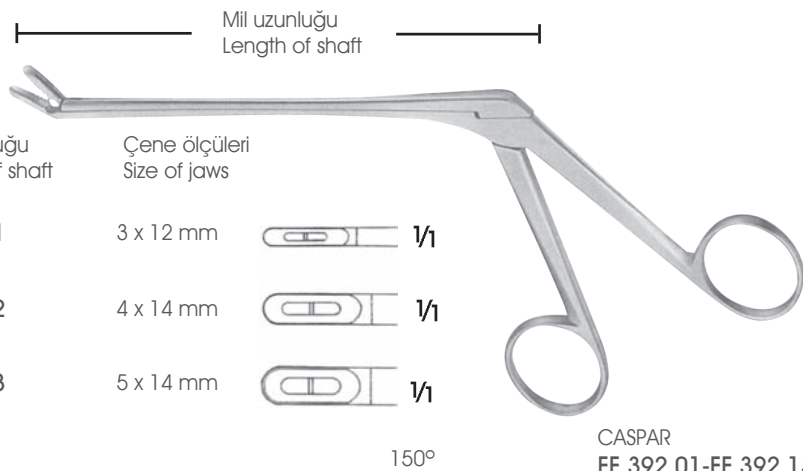

CASPAR
FF 392.01-FF 392.13

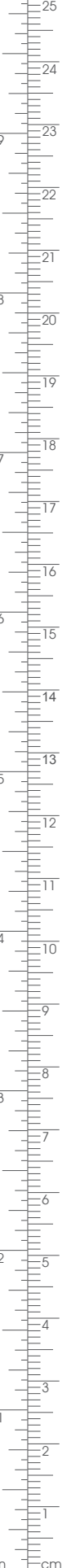

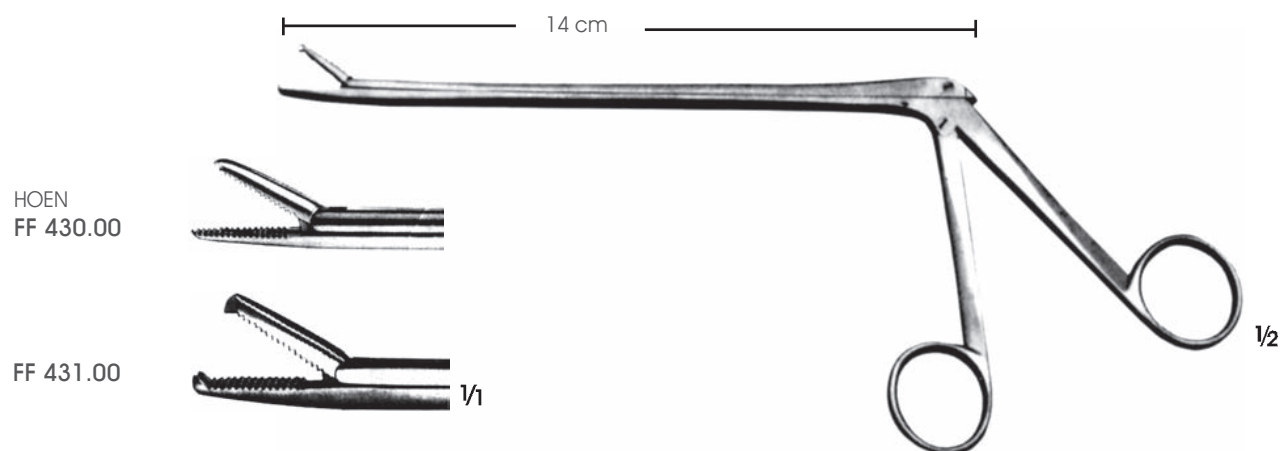
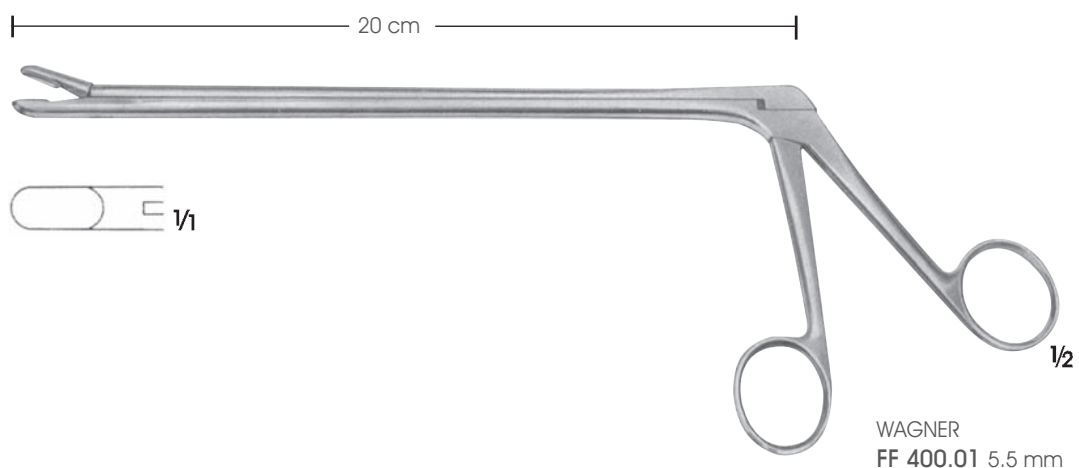
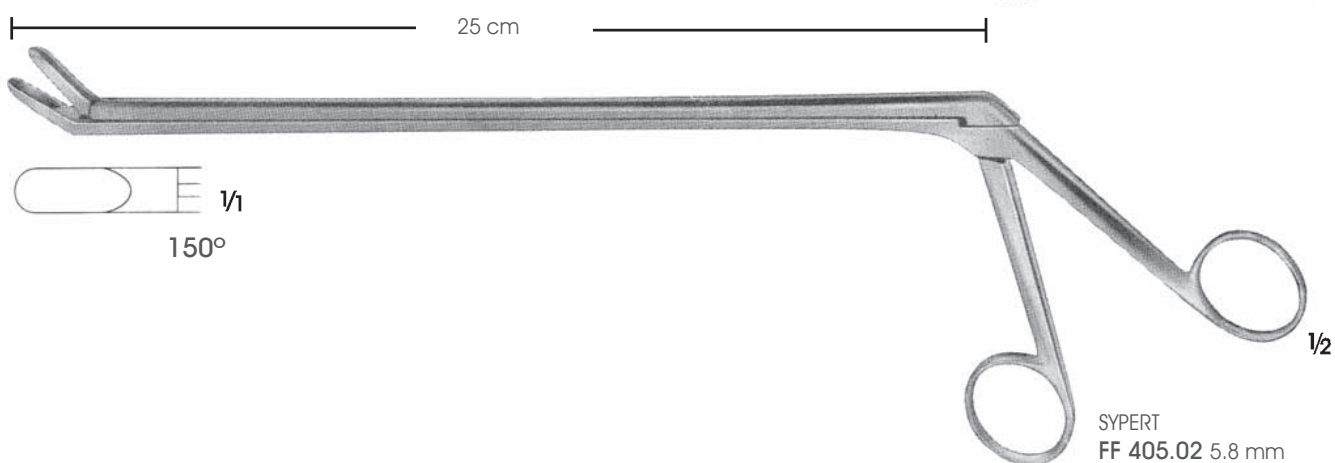
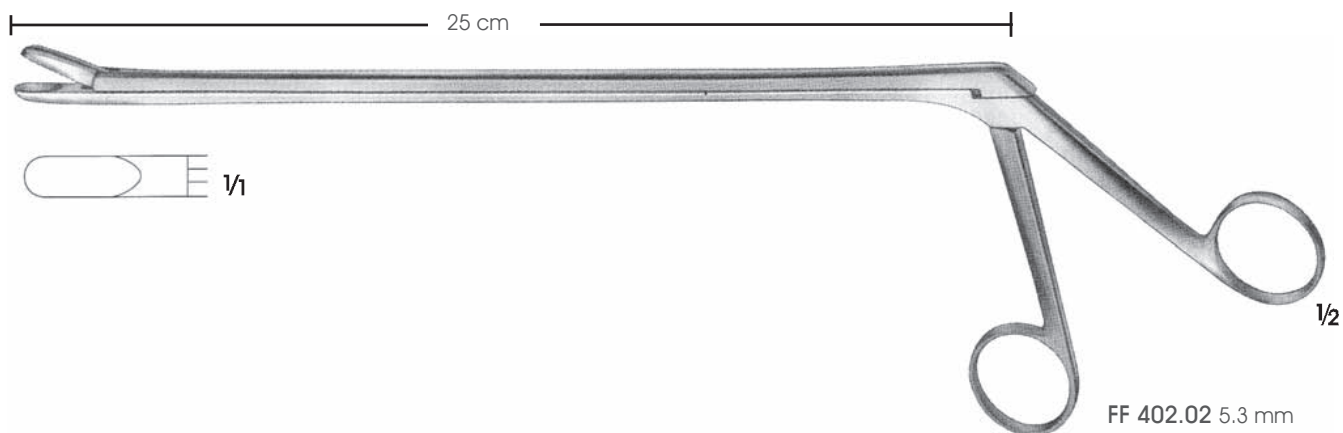

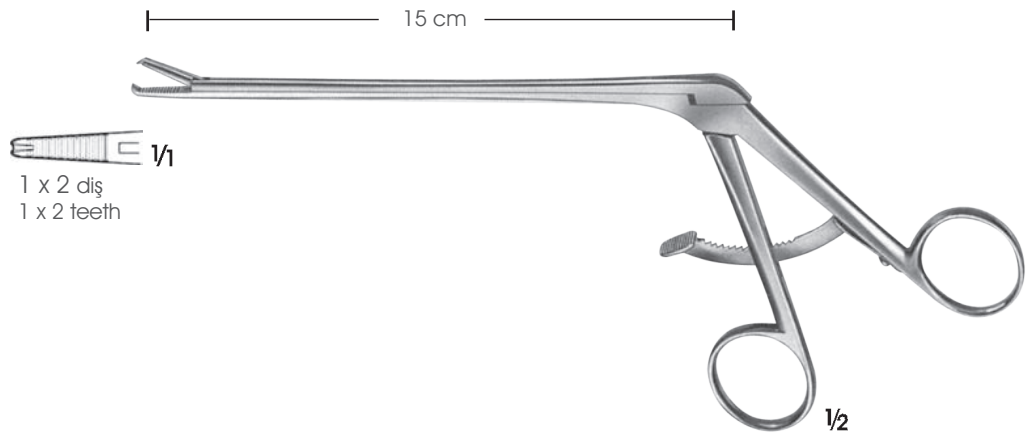

1 x 2 diş
1 x 2 teeth

KRAMER
FF 432.00 15 cm
Bağ tutucu grasping pens, kilittli
With catch grasping forceps for
ligamentum flavum

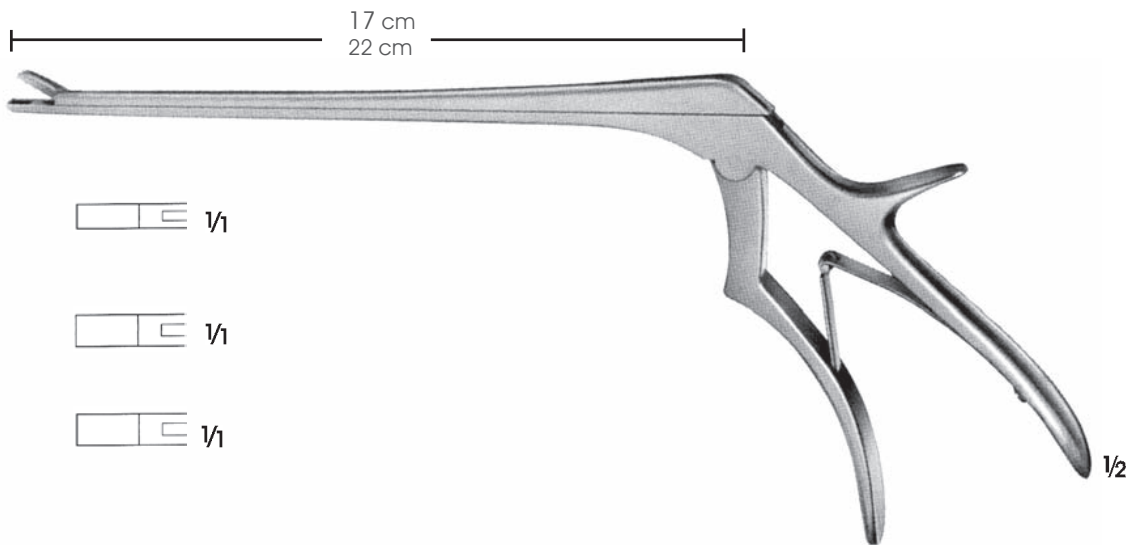

CASPAR
FF 450.02
3 mm 18 cm

1/1

CASPAR
FF 450.01
4 mm 18 cm

1/1

CASPAR
FF 450.05
4 mm 20.5 cm

1/1

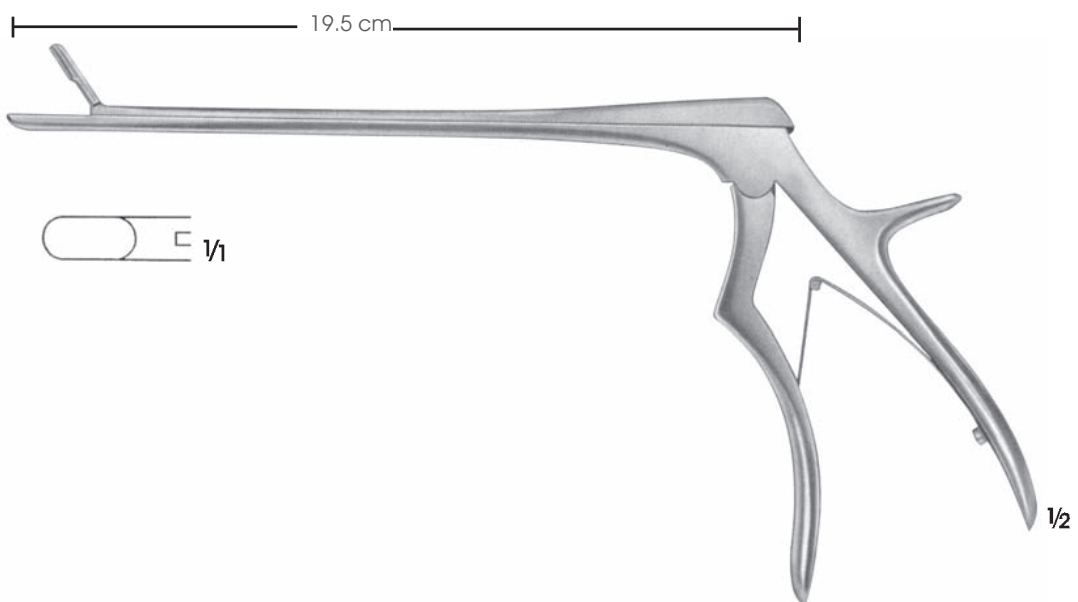

WAGNER
FF 455.01
5.5 mm

1/1

FF Beyin Cerrahi
Neurosurgery



 ARGENT

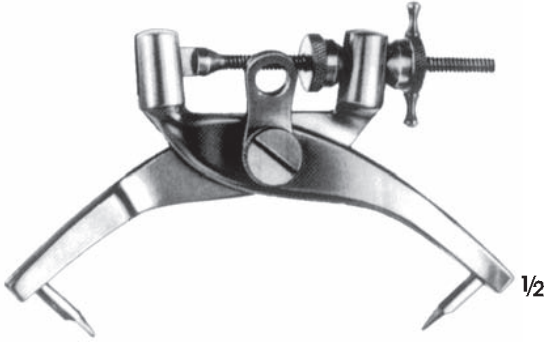

CRUTCHFIELD
FF 500.00
Çocuklar için/For children



CRUTCHFIELD
FF 500.02
Orta boy/Medium size



GARDNER-WELLS
FF 510.00
Maksimum açıklık (16 cm)
Maximum opening (16 cm)



FF 500.04
Matkap ucu, büyük
Drill point, large Ø 5
mm



FF 500.03
Matkap ucu, küçük
Drill point, small Ø
3.5 mm



FF 505.10
Anahtar/wrench



FF 505.01
Pimleri ayarlanabilir büyük boy
Traksiyon anahtarı ile
Large size Traction tongs with
adjustable pins and spanner
FF 505.10

FF 500.00
Komple/Complete
V 500.01-V 500.07

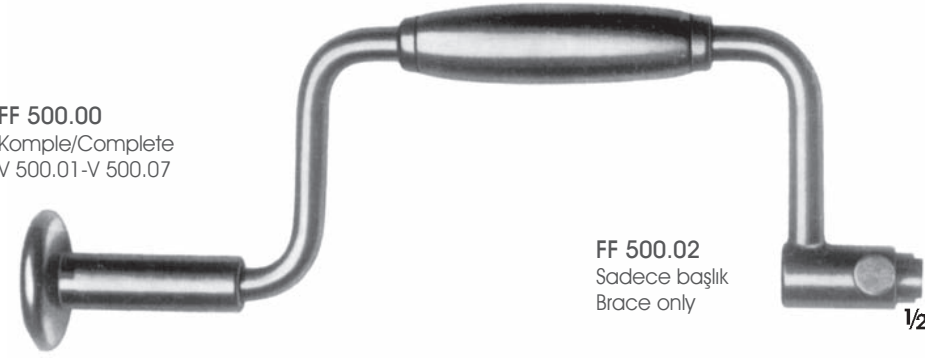

FF 500.02
Sadece başlık
Brace only



FF 500.01
Sadece uzatma parçası
Extension piece only

HUDSON DOWNS
FF 501.02
Sadece Başlık
Brace only

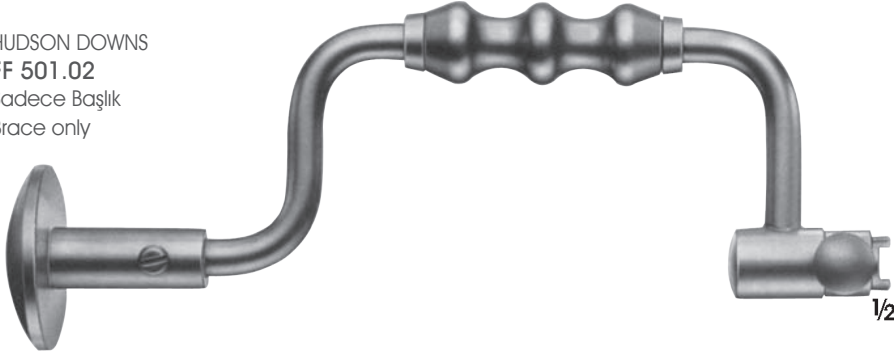

HUDSON DOWNS
FF 501.01
Uzatma parçası
Extension piece

HUDSON
FF 502.02
El matkabi
Hand drill



HUDSON
FF 502.01
Sadece uzatma parçası
Extension piece only

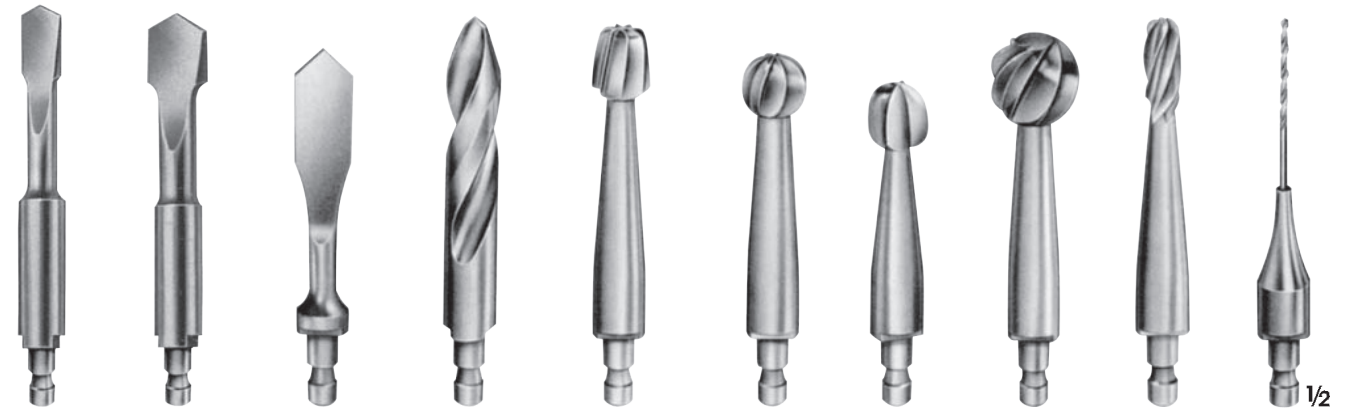

CUSHING
FF 500.15
Ø 10 mm

CUSHING
FF 500.17
Ø 15 mm

CUSHING
FF 500.03
Ø 14 mm

McKENZIE
FF 500.04
Ø 13 mm

HUDSON
FF 500.05
Ø 14 mm

HUDSON
FF 500.06
Ø 16 mm

ADSON
FF 500.08
Ø 15 mm

HUDSON
FF 500.10
Ø 22 mm

HUDSON
FF 500.11
Ø 9 mm

FF 500.07
Ø 2 mm



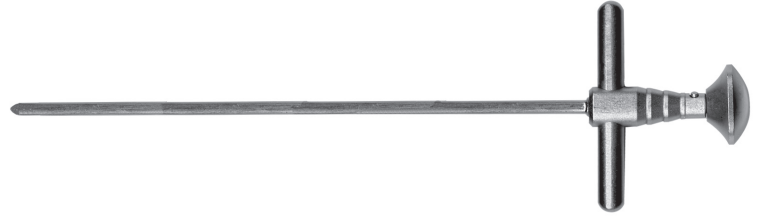
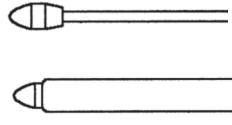

FF 543.00 Ø 4 mm
43.5 cm
FF 543.01 Ø 4 mm
60 cm

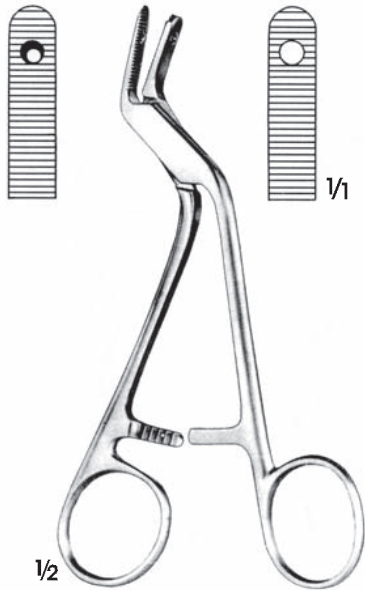

1/2
ADSON
FF 570.00
15 cm



1/2
FF 572.00
Koruma pensi
Protection forceps
20.5 cm

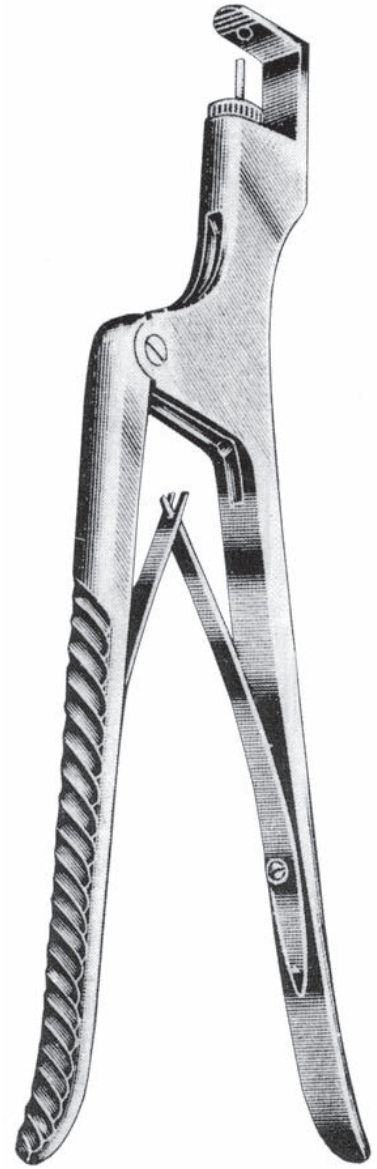

SWEET
FF 560.00 20 cm
FF 560.01 23 cm



1/1

GIGLI
FH 530.00
Sap/Handle

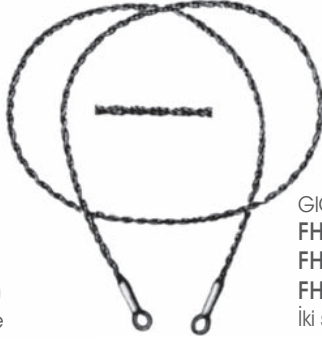

GIGLI
FH 536.00 30 cm
FH 536.01 40 cm
FH 536.02 50 cm
İki sargılı/Two windings

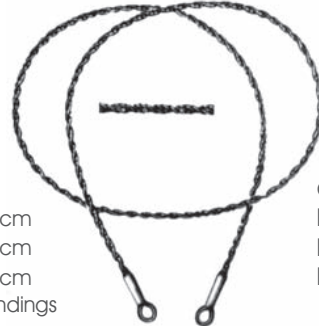

GIGLI
FH 537.00 30 cm
FH 537.01 40 cm
FH 537.02 50 cm
Üç sargılı/Three winding



1/2

DE MARTEL
FF 540.00 35 cm
Kondüktör için gigli testere teli, esnek
Gigli saw for the flexible conductor wire



DAHLGREN
FF 562.01



1/2

DE VILBISS
FF 564.00
1 huk dahil/with 1 hook
20 cm



1/2

DAHLGREN
FF 562.00
2 huk ile birlikte
With 2 extra hooks
21 cm



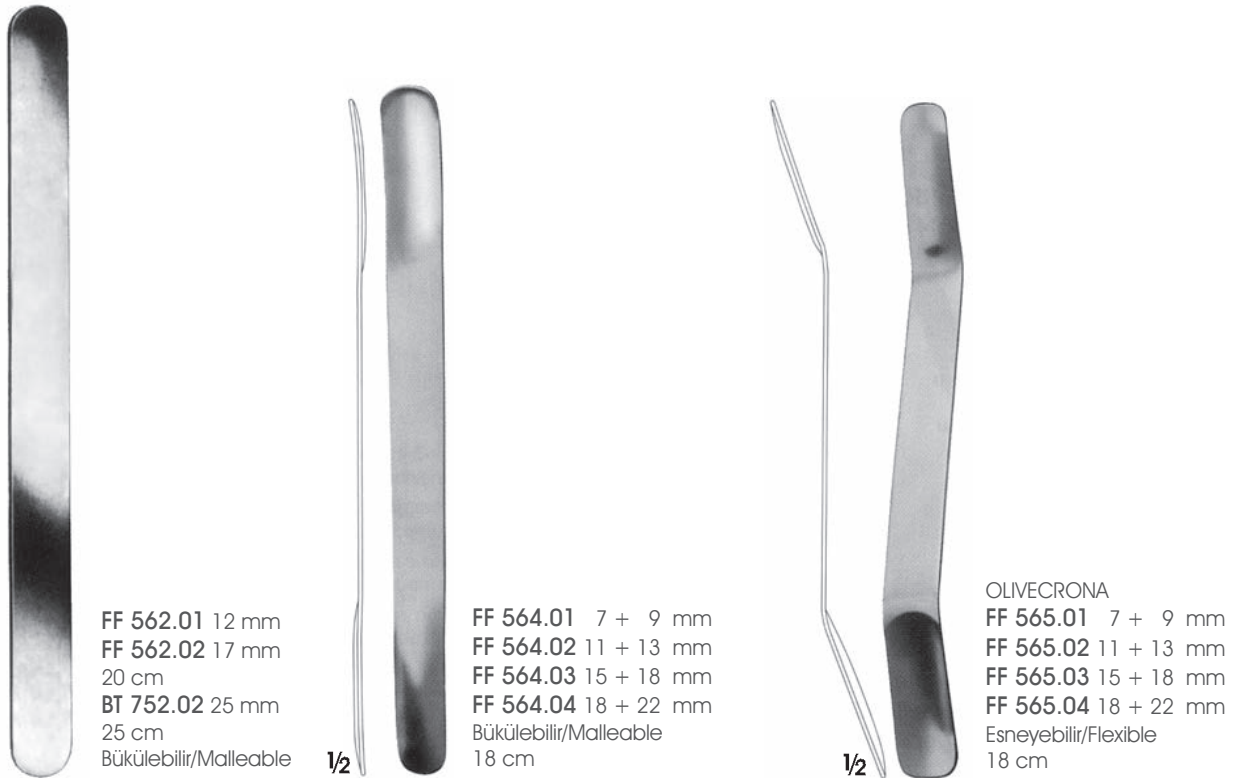
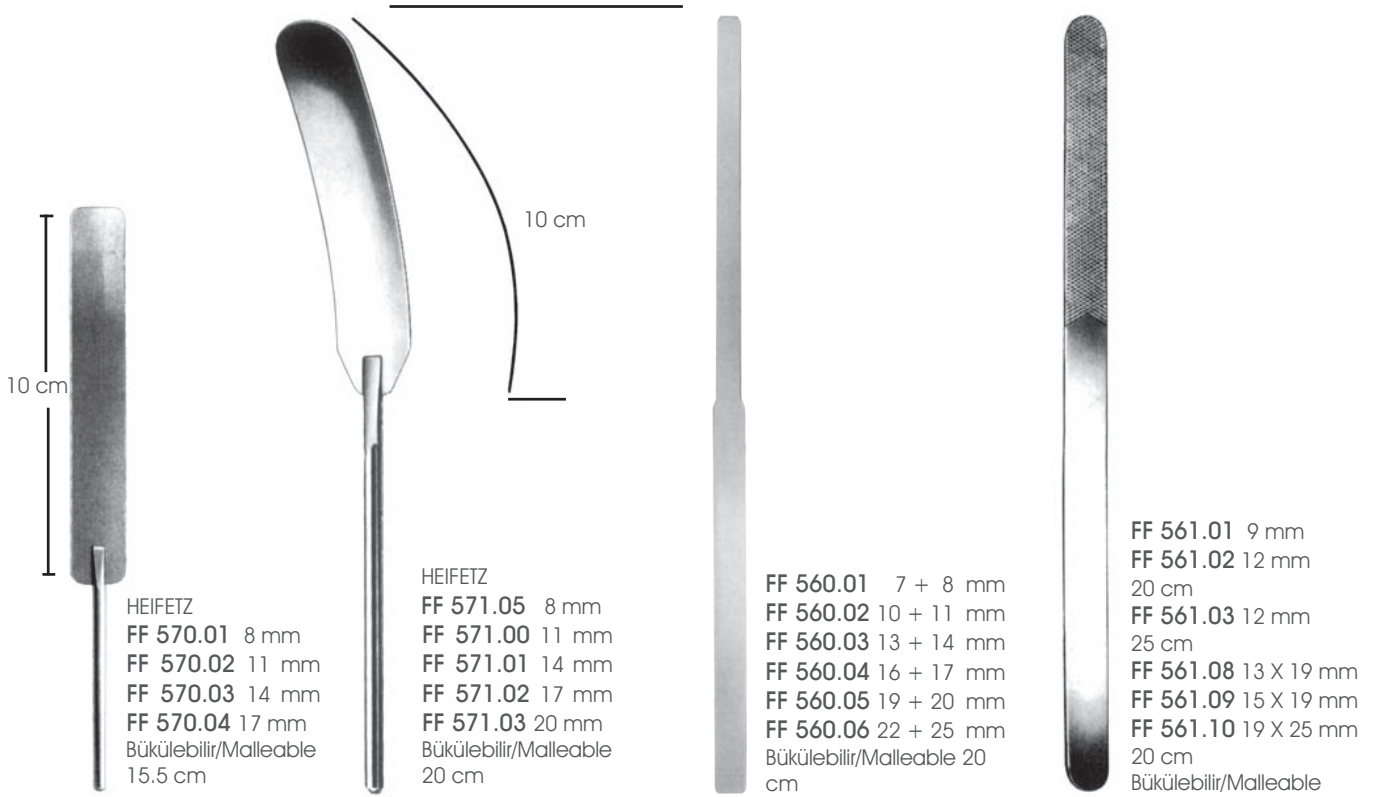

Silikon Kaplı Beyin Kaşığı

Bükülebilir silikon kaplı elastik metal kaşık
Atraumatik açma
Tek kullanımlık
10'luk Paket

Silikone Coated Brain Spatula

Malleable metal spatula with elastic silicone coating
Atraumatic retraction
For single use
1 package of 10 pieces



FF 559.00 6 mm
20 cm



FF 559.01 7.5 mm
20 cm



FF 559.02 10 mm
20 cm



FF 559.03 12.5 mm
20 cm



FF 559.04 15 mm
20 cm





RANEY
FF 550.00
16 cm

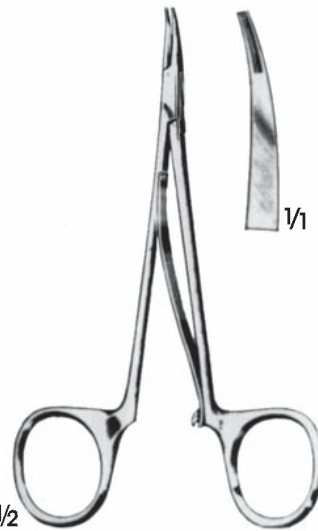

MC 1/2 KENZIE
FF 555.00
15 cm

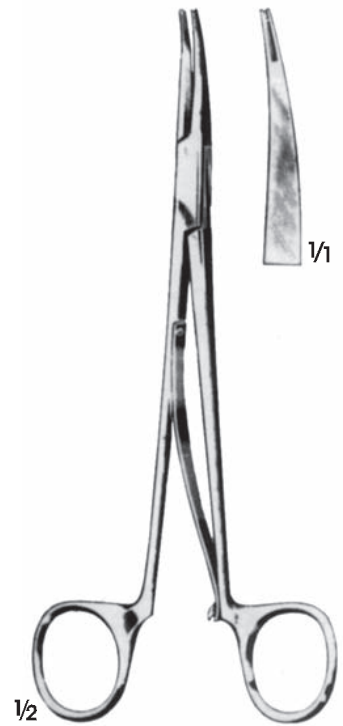

Mc KENZIE
FF 555.01
19 cm

Galea tespitinde kullanılan Buldog klampi yaylı kanca, örtü bezine bağlanabilir.
Spring hook for galea fixation with Bulldog clamp, to be fastened to covering drape.



YASARGIL
bt 500.00
26 cm

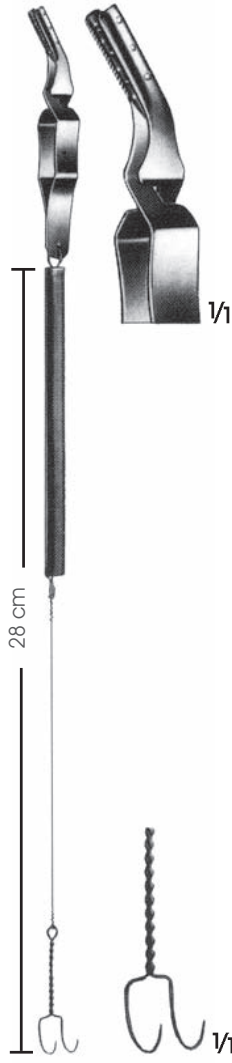

YASARGIL
bt 500.01
28 cm



FF 501.00
28 cm

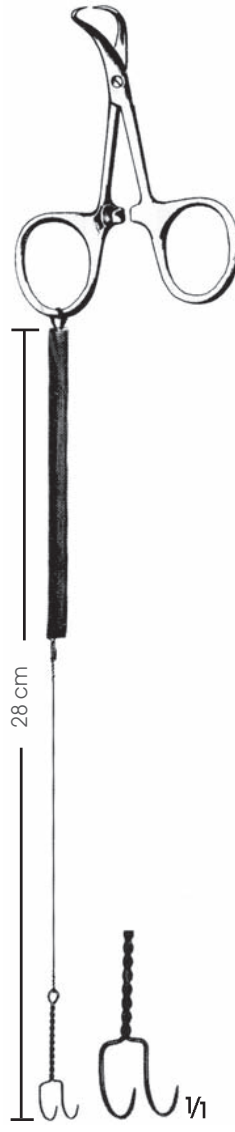

FF 502.00
28 cm

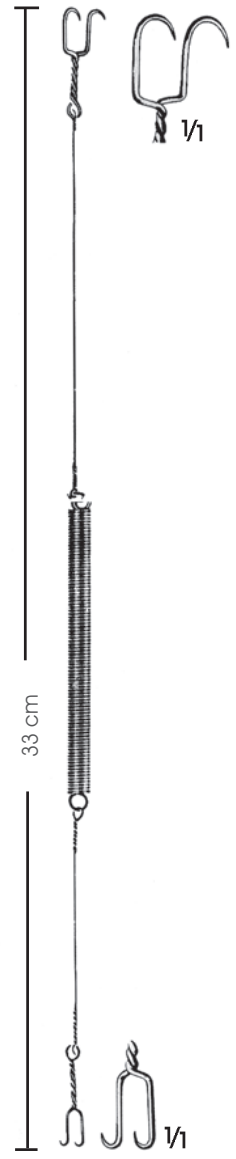

FF 504.00
33 cm

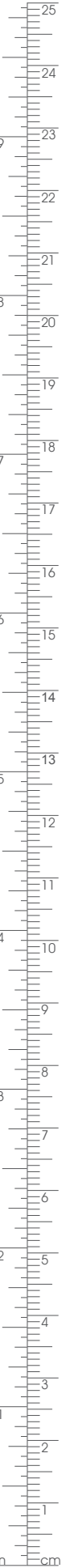



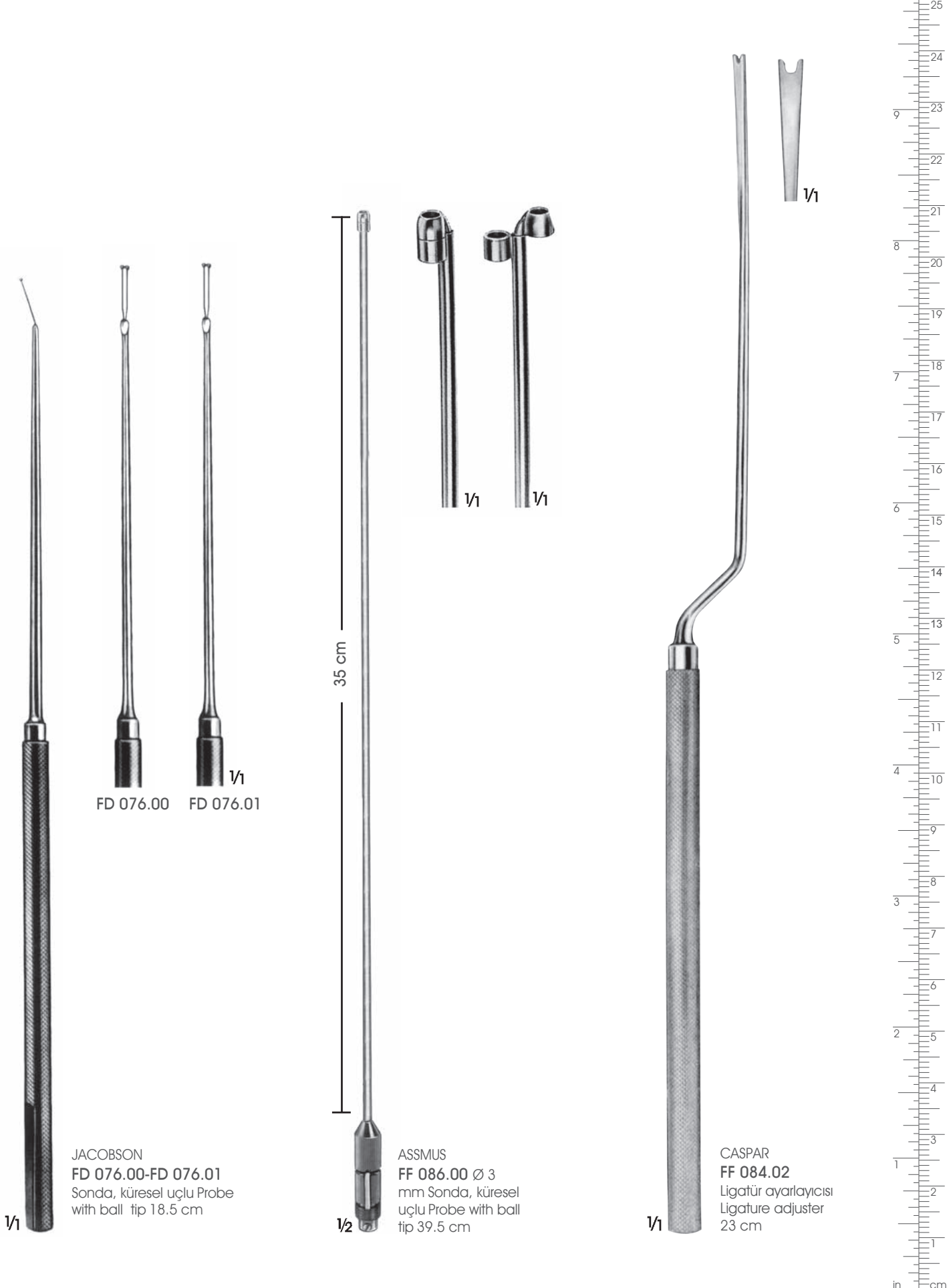

1/1

JACOBSON
FD 076.00-FD 076.01
Sonda, küresel uçlu Probe
with ball tip 18.5 cm

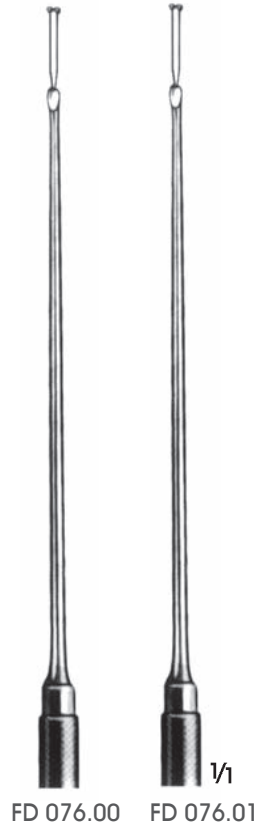

FD 076.00 FD 076.01

1/1



35 cm

1/2

ASSMUS
FF 086.00 Ø 3
mm Sonda, küresel
uçlu Probe with ball
tip 39.5 cm

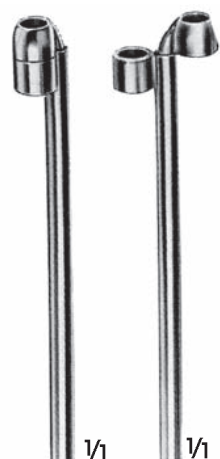

1/1

1/1



1/1

CASPAR
FF 084.02
Ligatür ayarlayıcısı
Ligature adjuster
23 cm



1/1



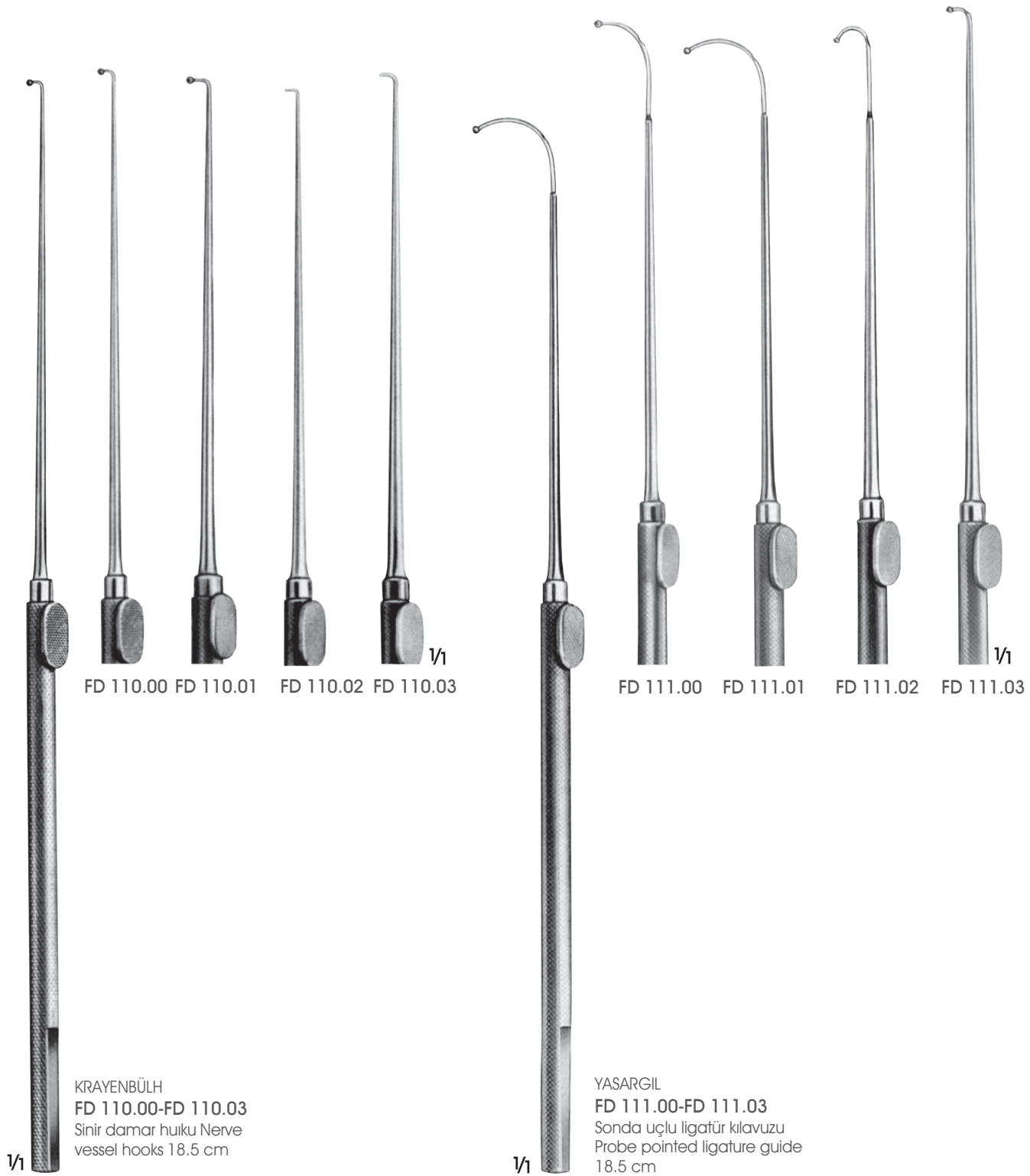

FD 110.00 FD 110.01 FD 110.02 FD 110.03 1/1

FD 111.00 FD 111.01 FD 111.02 FD 111.03 1/1

KRAYENBÜLH
FD 110.00-FD 110.03
Sinir damar huiku Nerve
vessel hooks 18.5 cm

YASARGIL
FD 111.00-FD 111.03
Sonda uçlu ligatür kılavuzu
Probe pointed ligature guide
18.5 cm



FD 145.00
Doku piki
Tissue pick
18.5 cm



FD 140.00
Sivri huk 90° açılı
Sharp hook, 90°
angled
18.5 cm



FISCH
FD 142.00
Sivri huk 90° açılı
Sharp hook, 90°
angled
18.5 cm



CASPAR
BT 112.00-BT 112.03
Keşif hukları sonda uçlu
Exploration hooks, probe-pointed
24.5 cm

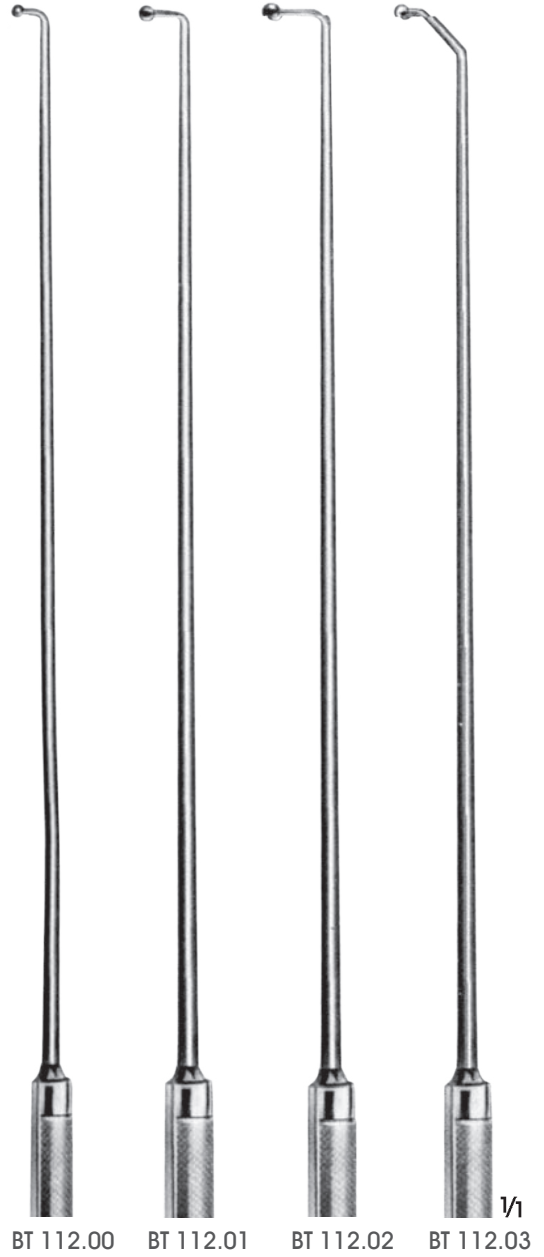



AC 306.00
Ayna sapı
Mirror handle
10.5 cm

AC 302.01
Laringel ayna
Laryngeal mirror
12 cm

OM 300.01
Altıgen saplı Laringel
aynar
Laryngeal mirror with
Hexagonal handle
18 cm

YASARGIL
AC 325.01 Ø 6 mm
Hareketli mikro ayna
Movable micro mirror
24 cm

AC 320.01
Ayna/Mirror
26 cm







FD 127.00
Raspa, plaka
şeklinde
Raspatory,
plate-shaped
23 cm



FD 125.01
Disektör, künt
Dissector, blunt
23 cm



FF 133.00 Disektör,
yukarı eğimli
Dissector, upwards
curved
23 cm



FF 134.00
Disektör künt,
aşağı eğimli
Dissector,
downwards
curved,blunt
23 cm



FD 128.00
Raspa, plaka
şeklinde
Raspatory,
plate-shaped
23 cm

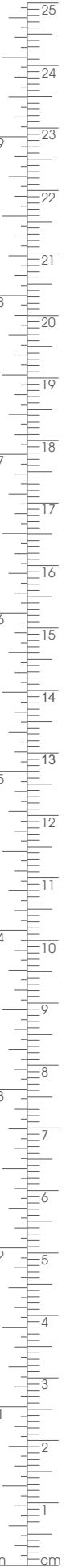





1/1



YASARGIL
FD 137.00
Mikro raspa, açılı
Micro raspatory,
angled
18.5 cm



YASARGIL
FD 137.01
Mikro disektör, açılı
Micro dissector,
angled
18.5 cm



YASARGIL
FD 137.02
Mikro disektör, açılı
Micro dissector,
angled
18.5 cm



YASARGIL
FD 137.03
Mikro raspa, hafif
kavisli
Micro raspatory,
slightly curved
18.5 cm



YASARGIL
FD 137.04
Mikro raspa, eğri
Micro raspatory,
curved
18.5 cm



YASARGIL
FD 138.00
Mikro raspa, aşağı eğimli
Micro raspatory, down-
wards curved
18.5 cm



YASARGIL
FD 138.01
Mikro raspa, aşağı eğimli
Micro raspatory, down-
wards curved
18.5 cm



YASARGIL
FD 138.02
Mikro raspa, yukarı eğimli
Micro raspatory, up-
wards curved
18.5 cm



YASARGIL
FD 102.00
Mikro kaşık küret
Micro scoop
18.5 cm





1/1

1/1

JACOBSON
FD 064.00
Damar bıçağı
Vessel knife
18.5 cm

FD 060.00-FD 062.03
18.5 cm



KOOS
FD 060.00
Yukarı eğimli
Curved upwards



KOOS
FD 060.01
Aşağı eğimli
Curved downwards



KOOS
FD 060.02
Yukarı eğimli
Curved upwards



KOOS
FD 060.03
Aşağı eğimli
Curved downwards



KOOS
FD 062.00
Aşağı eğimli
Curved downwards



KOOS
FD 062.01
Yukarı eğimli
Curved upwards



YAŞARGIL
FD 062.02
Aşağı eğimli
Curved downwards



YAŞARGIL
FD 062.03
Yukarı eğimli
Curved upwards

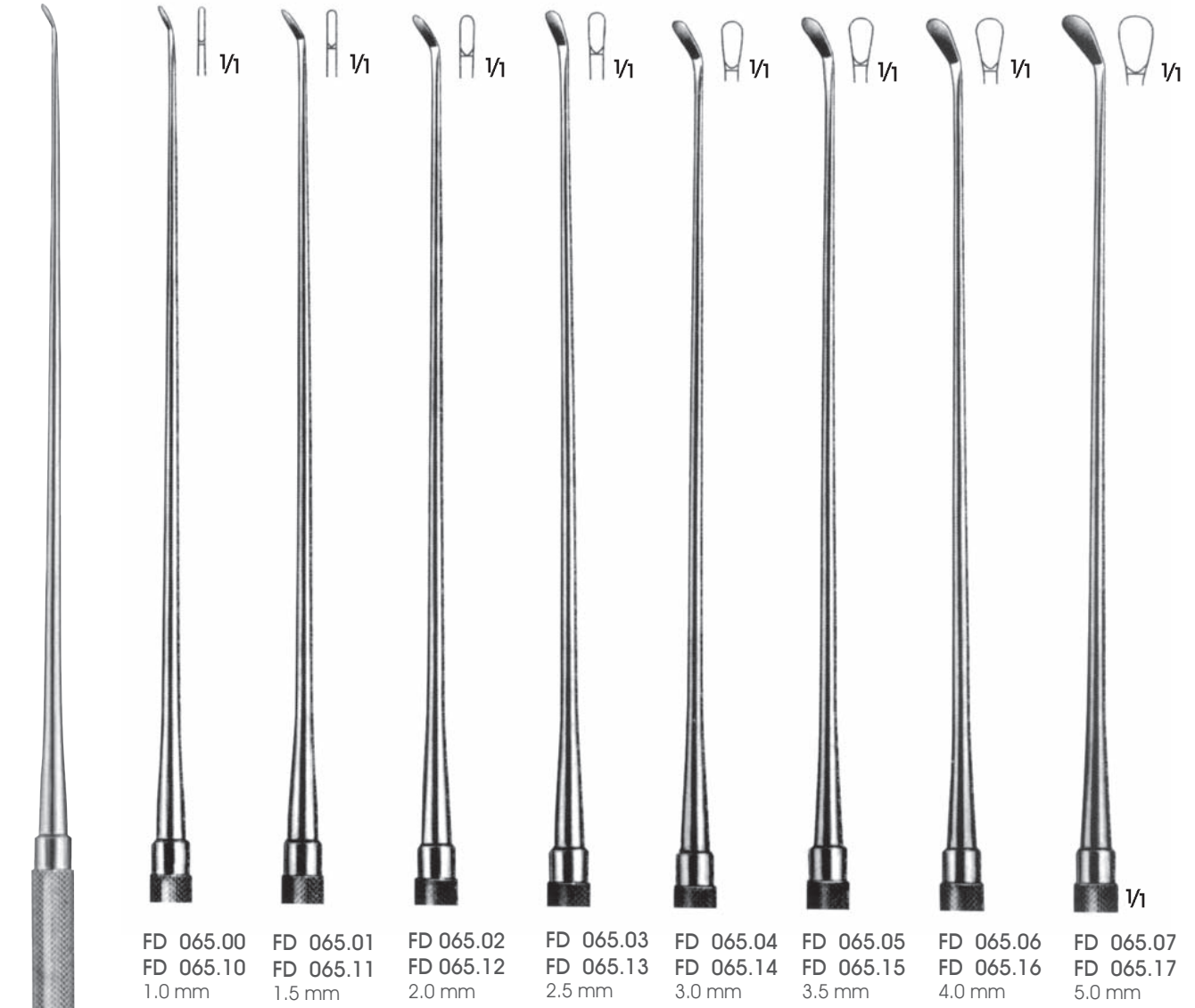

$\frac{1}{1}$ SAMII
FD 065.00-FD 065.07
20 cm
FD 065.10-FD 065.17
23 cm





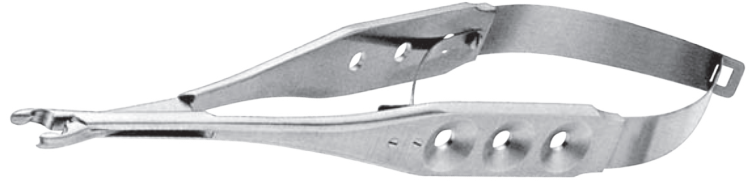

YASARGIL
FE 595.00 Mini/Mini
FE 595.01 Standart/Standard
17,5 cm

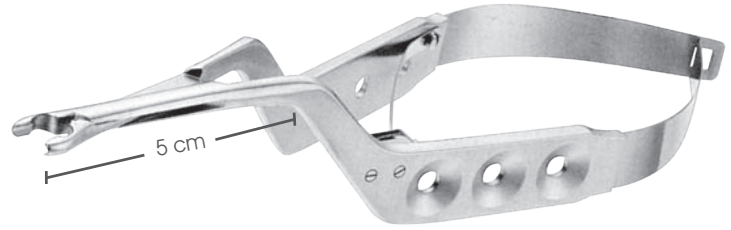

YASARGIL
FE 596.00 Mini/Mini
FE 596.01 Standart/Standard
17,5 cm

Mini/Mini Standart/Standard

FE 596.02 FE 596.03
Düz/Straight



FE 597.02 FE 597.03
15° Açılı/15° Angled



FE 598.02 FE 598.03
30° Açılı/30° Angled

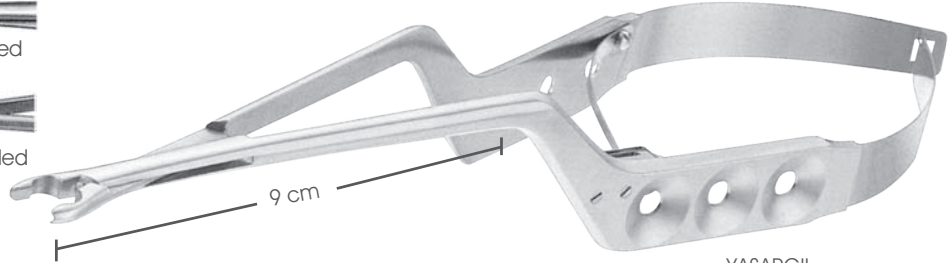

YASARGIL
FE 596.02-FE 596.03
FE 597.02-FE 597.03
FE 598.02-FE 598.03
21.5 cm

FE 596.04 FE 596.05
Düz/Straight



FE 597.04 FE 597.05
15° Açılı/15° Angled



FE 598.04 FE 598.05
30° Açılı/30° Angled

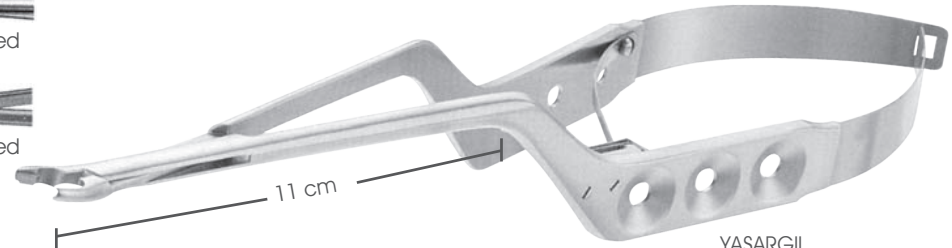

YASARGIL
FE 596.04-FE 596.05
FE 597.04-FE 597.05
FE 598.04-FE 598.05
23.5 cm



FE 591.01
Hizalama anahtarı
Alignment key

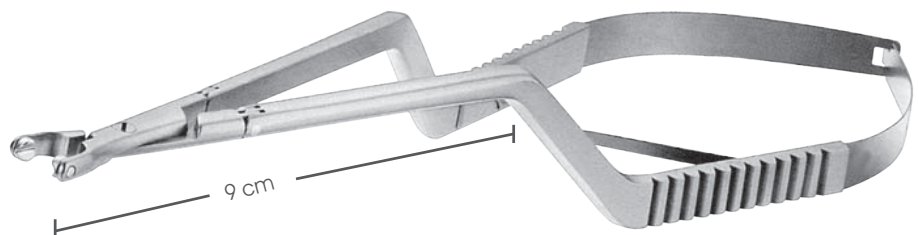

FE 590.00 Mini/Mini
FE 590.01 Standart/Standard
21.5 cm

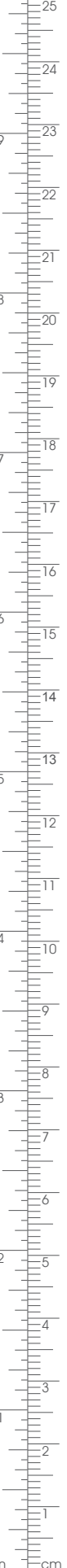

Düz Straight 15° Açılı 15° Angled 30° Açılı 30° Angled

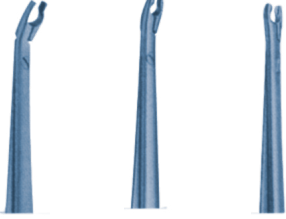

OG 340.03OG Mini/Mini OG 350.03OG Standart Standard 22 cm	OG 341.03OG Mini/Mini OG 351.03OG Standart Standard 22 cm	OG 343.03OG Mini/Mini OG 353.03OG Standart Standard 22 cm
--	--	--

Düz Straight 15° Açılı 15° Angled 30° Açılı 30° Angled



OG 340.06OG Mini/Mini OG 350.06OG Standart Standard 25 cm	OG 341.06OG Mini/Mini OG 351.06OG Standart Standard 25 cm	OG 343.06OG Mini/Mini OG 353.06OG Standart Standard 25 cm
--	--	--

Mini/Mini Standart/Standard

OG 330.01OG OG 332.01OG

OG 330.03OG OG 332.03OG

OG 330.05OG OG 332.05OG



YASARGIL
OG 340.01OG Mini/Mini
OG 350.01OG Standart/Standard
18 cm

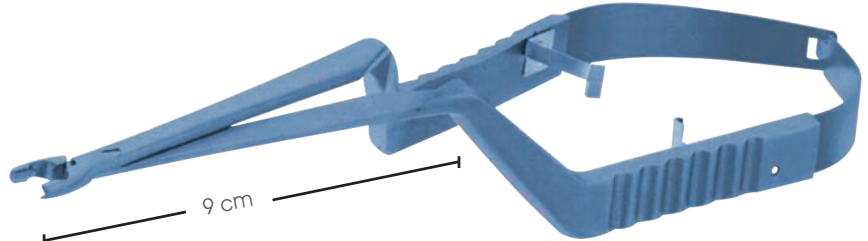

YASARGIL
OG 340.03OG-OG 350.03OG
OG 341.03OG-OG 351.03OG
OG 343.03OG-OG 353.03OG

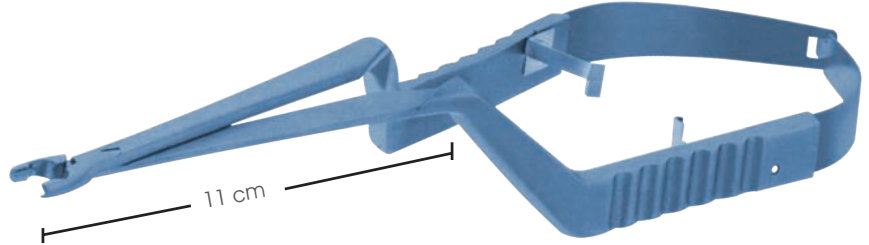

YASARGIL
OG 340.06OG-OG 350.06OG
OG 341.06OG-OG 351.06OG
OG 343.06OG-OG 353.06OG



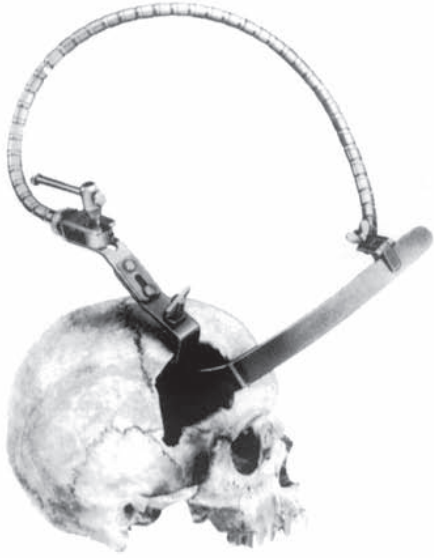

YASARGIL
FF 530.00
Tek kollu komple otomatik beyin ektartörü Self-retaining brain retractor, with 1 flexible arm, complete, consisting of:
FF 530.11 Tespit elemanı/Fixation base
FF 530.05 Yalnız esnek kol/Flexible arm only
FF 530.15 Kaşık tutucu/Support for spatula

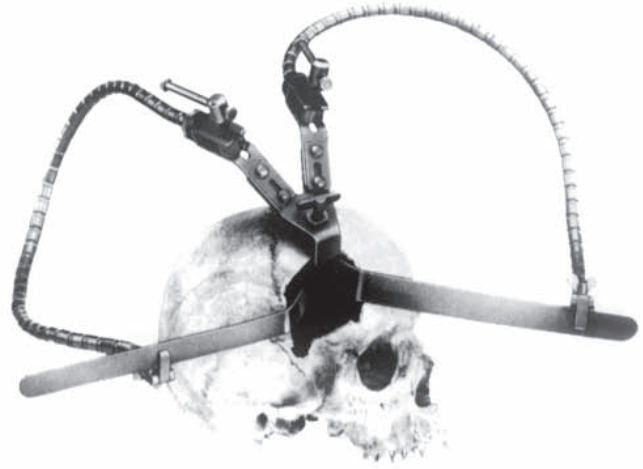

YASARGIL
FF 530.01
İki kollu komple otomatik beyin ektartörü Self-retaining brain retractor, with 1 flexible arm, complete, consisting of:
FF 530.12 Tespit elemanı (1 adet)/Fixation base (1 each)
FF 530.05 Yalnız esnek kol (2 adet)/Flexible arm only (2 each)
FF 530.15 Kaşık tutucu (2 adet)/Support for spatula (2 each)

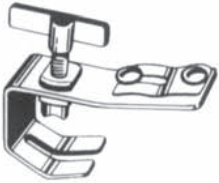

FF 530.10
Tespit elemanı
Fixation base



YASARGIL
FF 530.05
Yalnız esnek kol
Flexible arm only

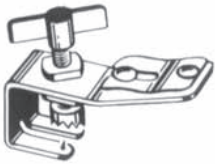

FF 530.11
Tespit elemanı
Fixation base

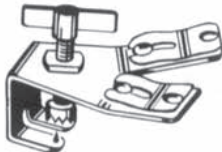

FF 530.12
Tespit elemanı
Fixation base

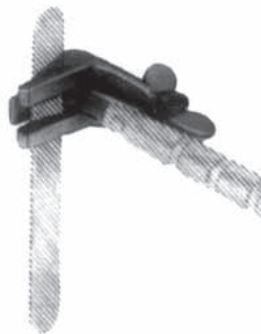

FF 530.15
Kaşık tutucu/Support only

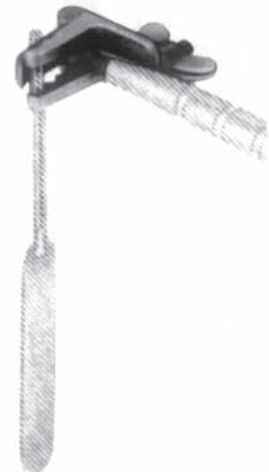

FF 530.16
Kaşık tutucu/Support only

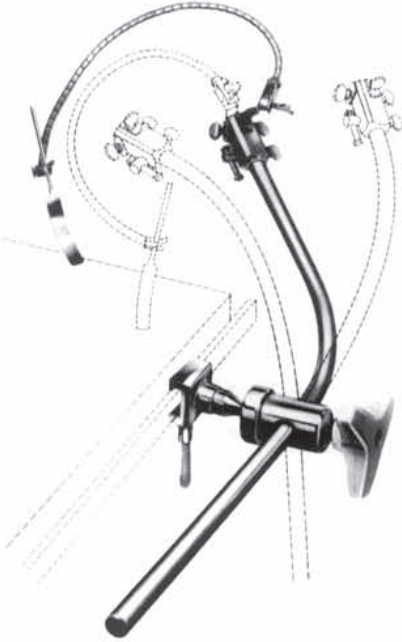

FF 530.20

FF 530.32 Masa bağlantı mafsalı/Ball-and socket joint
FF 530.35 Tutucu mil/Holding rod
FF 530.30 Bağlantı başlığı/Coupling head
FF 530.05 Yalnız esnek kol/Flexible arm only
FF 530.16 Kaşık tutucu/Support for spatula

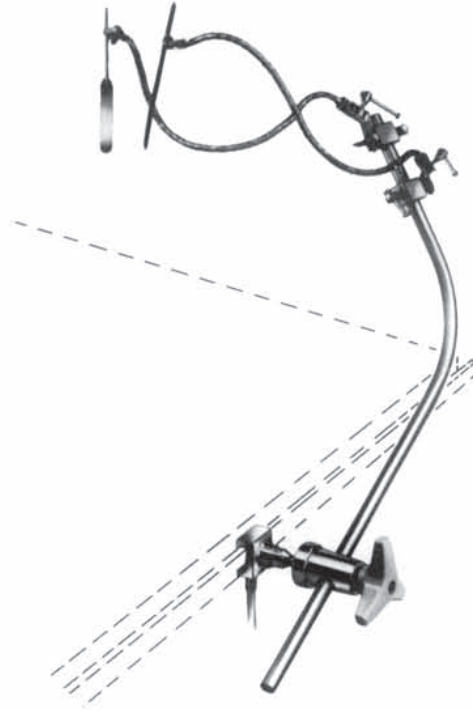

FF 530.21

FF 530.32 Masa bağlantı mafsalı/Ball-and socket joint
FF 530.35 Tutucu mil/Holding rod
FF 530.34 2 adet bağlantı başlığı/Coupling head (2 each)
FF 530.05 2 adet yalnız esnek kol/Flexible arm only (2 each)
FF 530.15 Kaşık tutucu/Support for spatula
FF 530.16 Kaşık tutucu/Support for spatula

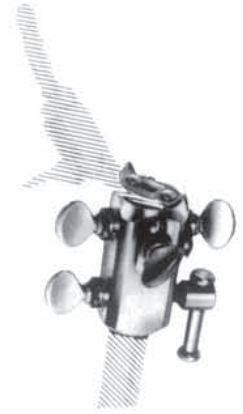

S 530.30
Bağlantı başlığı
Coupling head



FF 530.29

Masa bağlantı mafsalı
Joint for table fixation
maximum 9 x 32 mm

FF 530.32

Masa bağlantı mafsalı
Joint for table fixation
10 x 25 mm



FF 530.33

Döner bağlantı başlığı
Turnable coupling head

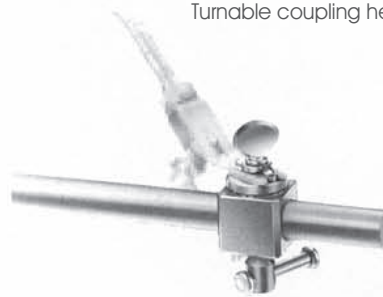

FF 530.34

Döner bağlantı başlığı
Turnable coupling head



FF 530.35

Tutucu mil
Holding rod



FF 531.12

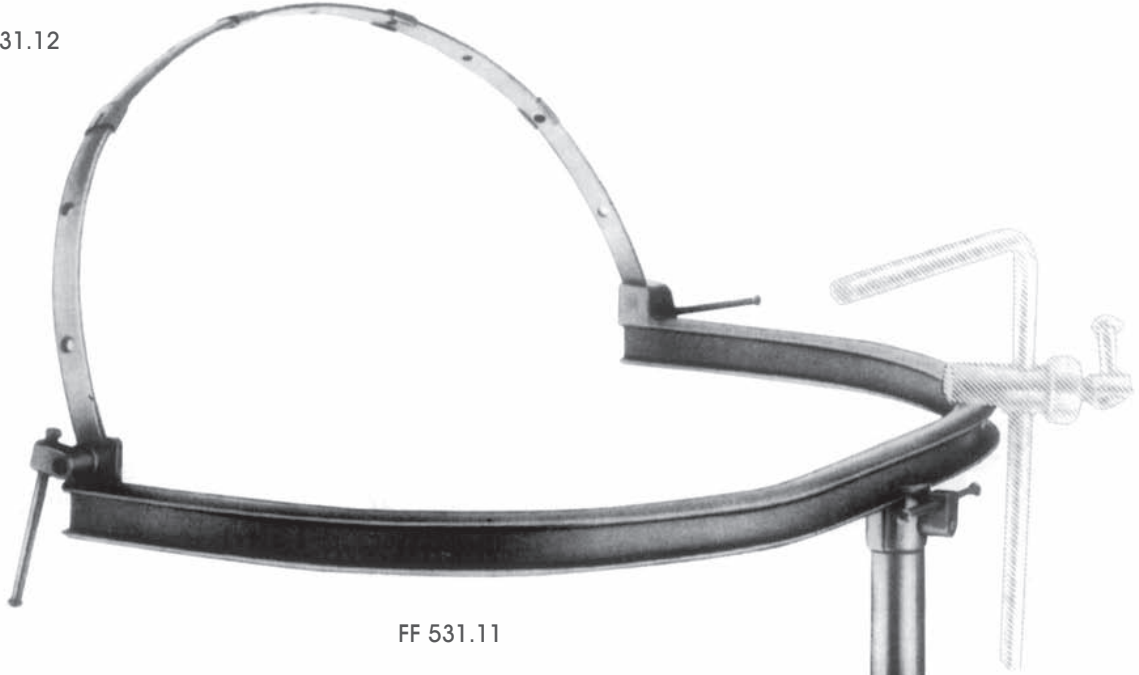

FF 531.11

FF 531.10

GILSBACH

FF 531.00 (Komple/Complette)

Temel ünite/Basic unit

FF 531.10 Tutucu mil/Holding rod

FF 531.11 Esnek kollar için yarım daire bar/Semi-circular basic bar, for flexible arms

FF 531.12 Galea hukları için çerçeve/Frame for Galea hook

GILSBACH EKARTÖR SETİ/GILSBACH RETRACTOR SYSTEM

FF 531.01 (Komple/Complette)

FF 505.00 4 Adet/4 Each

FF 530.07 2 Adet/2 Each

FF 530.15 1 Adet/1 Each

FF 530.16 1 Adet/1 Each

FF 530.50 1 Adet/1 Each

FF 531.00 1 Adet/1 Each

FF 531.02 1 Adet/1 Each

FF 531.08 1 Adet/1 Each

FF 530.37 1 Adet/1 Each

FF 530.39 1 Adet/1 Each

JG 110.15 1 Adet/1 Each

JG 191.05 1 Adet/1 Each

JG 191.07 1 Adet/1 Each



FF 531.02 Masa bağlantı elemanı/Table Fixation attachment

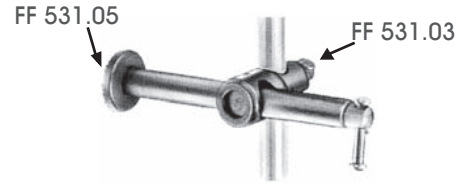
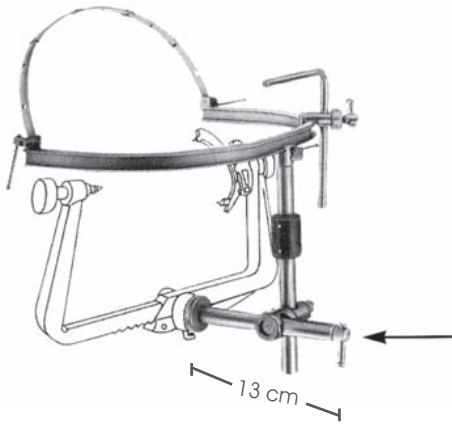

FF 531.08 Komple/Complete
FF 531.03 Masa bağlantı elemanı/Table Fixation attachment(1 adet)
FF 531.05 Masa bağlantı elemanı/Table Fixation attachment (1 pcs)

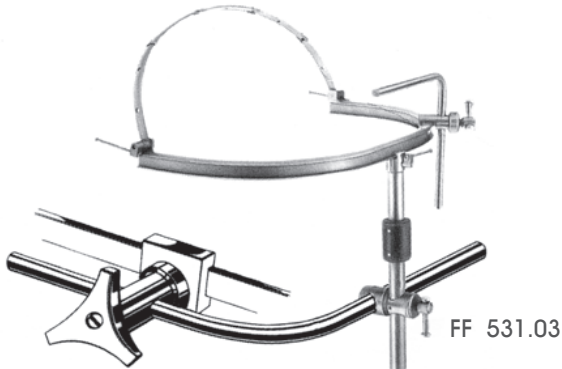

FF 530.29
FF 530.32

FF 530.35

FF 531.03

FF 531.03 Masa bağlantı elemanı/Table Fixation attachment
FF 530.35 Tutucu mil/Holding rod
FF 530.29 Masa bağlantı mafsalı/Joint for table fixation
9 x 32 mm
FF 530.32 Masa bağlantı mafsalı/Joint for table fixation
10 x 25 mm



FF 530.39
Pens tutucu
Holder for forceps



GILSBACH
FF 530.37
El dayama barı
Handrest bar



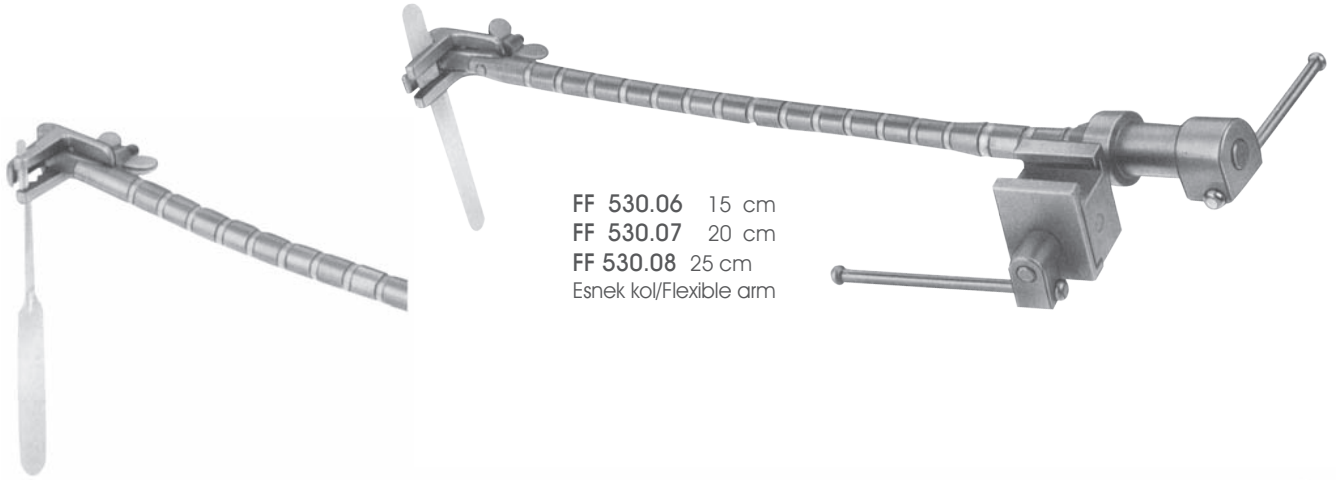

FF 530.06 15 cm
FF 530.07 20 cm
FF 530.08 25 cm
Esnek kol/Flexible arm

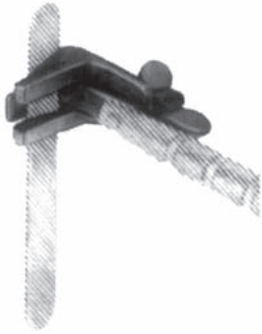

FF 530.04
Esnek kol/Flexible arm



FF 530.15
Kaşık tutucu
Support only



FF 530.16
Kaşık tutucu
Support only

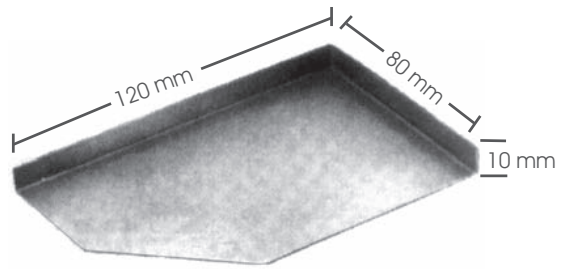

FF 530.50
FF 530.05 ve FF 0.15 ile
sabitnebilir tabla.
Tray can be to the FF 350.05
and FF 530.15



FF 505.00
Zincirli huk (SFF 531.12 ile
kullanılır) Chain hook (Used to
FF 531.12)



FF 506.00
Yaylı huk (FF 531.12 ile
kullanılır) Spring hook (Used to
FF 531.12)





MAYFIELD
FF 540.01
Kafa klempi/Skull clamp

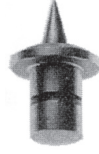

GARDNER
FF 540.20 10
mm Yetişkinler için
Adult size
25 mm



MAYFIELD
FF 540.06
Yetişkinler için
Adult size



MAYFIELD
FF 540.07
Çocuklar için
Child size

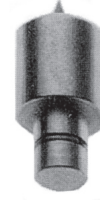

GARDNER
FF 540.21 6 mm
Çocuklar için
Child size
38 mm

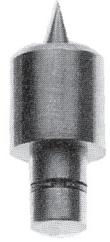

MT.SINAI
FF 540.22 10 mm
Çocuklar için Child
size
38 mm

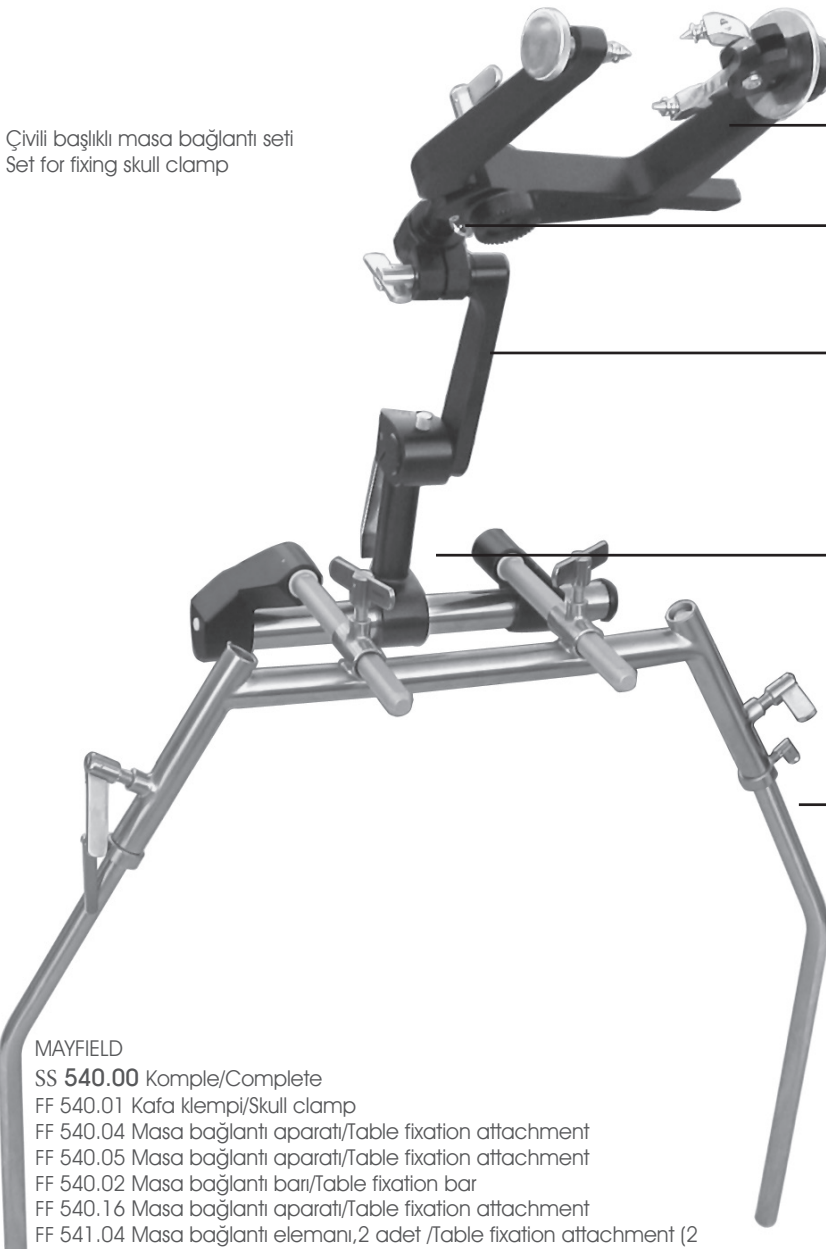

Çivili başlıklı masa bağlantı seti
Set for fixing skull clamp

MAYFIELD
FF 540.01
Kafa klempi/Skull clamp

MAYFIELD
FF 540.16
Masa bağlantı aparatı
Table fixation attachment

MAYFIELD
FF 540.05
Masa bağlantı aparatı
Table fixation attachment

MAYFIELD
FF 540.04
Masa bağlantı aparatı
Table fixation attachment

MAYFIELD
FF 540.02
Masa bağlantı aparatı
Table fixation attachment

MAYFIELD
SS 540.00 Komple/Complete
FF 540.01 Kafa klempi/Skull clamp
FF 540.04 Masa bağlantı aparatı/Table fixation attachment
FF 540.05 Masa bağlantı aparatı/Table fixation attachment
FF 540.02 Masa bağlantı barı/Table fixation bar
FF 540.16 Masa bağlantı aparatı/Table fixation attachment
FF 541.04 Masa bağlantı elemanı, 2 adet /Table fixation attachment (2 each)



MAYFIELD
FF 541.04
Masa bağlantı aparatı
Table fixation attachment

FF 542.00 Komple/Complete

FF 542.02 1 adet/1 each
FF 542.03 1 adet/1 each
FF 542.06 1 adet/1 each
Pediatrik kafa dayanağı uzatma çubuğu ile
Headrest pediatric with extension bar

FF 542.01 Komple/Complete

FF 542.04 1 adet/1 each
FF 542.05 1 adet/1 each
FF 542.07 1 adet/1 each
Yetişkinler için kafa dayanağı uzatma çubuğu ile
Adults with headrest extension bar

FF 542.10

Jel kulak halkası 90 mm
Gel ear ring base 90 mm

FF 542.12

Jel kulak halkası 90 mm
Gel ear ring base 90 mm

FF 542.14

Jel baş halkası 140 mm
Gel head ring base 140 mm

FF 542.06
Uzatma çubuğu
Extension bar

FF 542.02
Kafa dayanağı, sağ
Headrest title, right

FF 542.03
Kafa dayanağı, sol
Headrest title, left

FF 542.07
Uzatma çubuğu
Extension bar

FF 542.04
Kafa dayanağı, sağ
Headrest title, right

FF 542.05
At balı başlık, sol
Horseshoe title, left

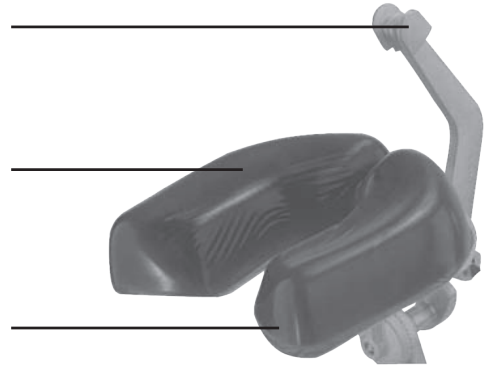

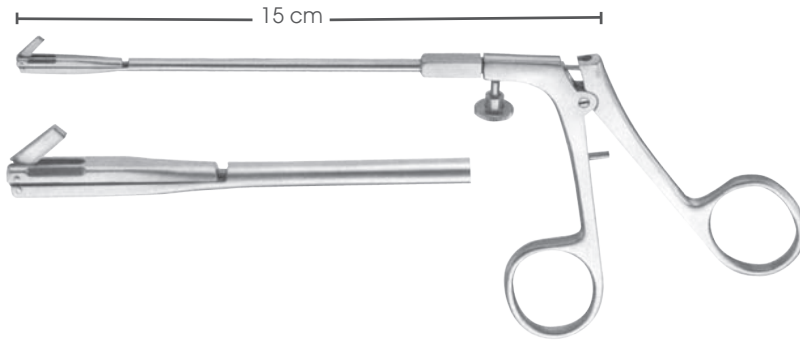

FB 470.00
Antrum panç
Antrum punch

HARD COATED



CX 644.00
Anahtar/Key
15 cm

PAPAVERO-CASPAR
FF 298.01 80 x 11 mm
FF 298.02 90 x 13 mm
FF 298.03 100 x 15 mm

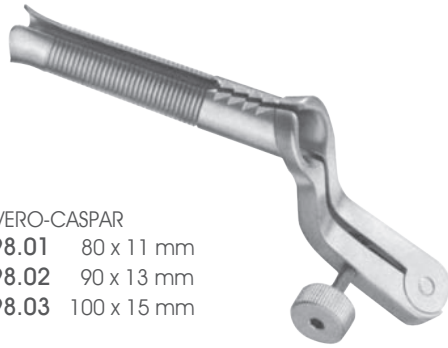

CX 644.00 ile beraber
With key CX 644.00
İnce profilli, hafif transsfenoidal spekulum
Slim profile and lightweighted specula for
transsphenoidal



FF 298.02B 90 x 13 mm
Transsfenoidal spekulum
Transsphenoidal specula



PAPAVERO-HARTMANN
FF 265.00
FF 298.01, FF 298.02, FF 298.03 ile
birlikte Use with FF 298.01, FF 298.02,
FF 298.03

$\frac{1}{1}$
34 x 9 mm



COTTLE
FF 275.02-FF 275.03
Burun spekulumu/Nasal speculum
FF 298.01, FF 298.02, FF 298.03 ile
birlikte Use with FF 298.01, FF 298.02,
FF 298.03 13.5 cm

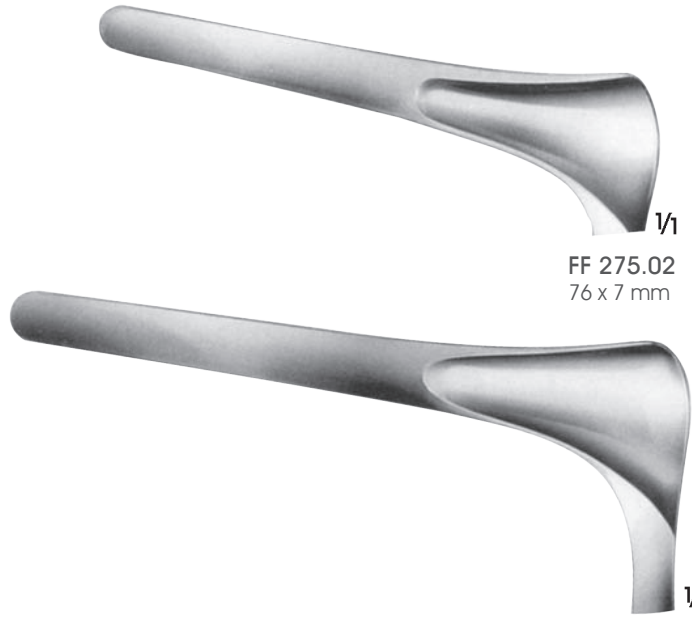

$\frac{1}{1}$
FF 275.02
76 x 7 mm

$\frac{1}{1}$
FF 275.03
90 x 7 mm



CUSHING-LANDOLT
OK 295.00 70 x 15 mm
OK 295.01 90 x 15 mm
OK 295.02 110 x 15 mm
Transsfenoidal, hipofizektomi spekulum
Specula for transsphenoidal hypophysectomy



JANSEN-MIDDLETON
OK 580.00
20 cm



COTTLE
OL 631.01 4 mm
OL 631.02 7 mm
OL 631.03 9 mm
OL 631.04 12 mm
Derinlik işaretli çizil
Chisel with depth markings
18 cm



PAPAVERO
OF 613.00 4 mm
Bayonet çizil
Bayonet chisel, 4 mm
22 cm



LANDOLT
OK 296.00
Spekulum için ayırıcı
Spreader for specula
OK 295.00-OK
295.02 21 cm



COTTLE
FL 815.01 240 gr
Çekiç, bir tarafı düz
bir tarafı dış bükey
Mallet, 1 side flat, 1
side convex
18.5 cm



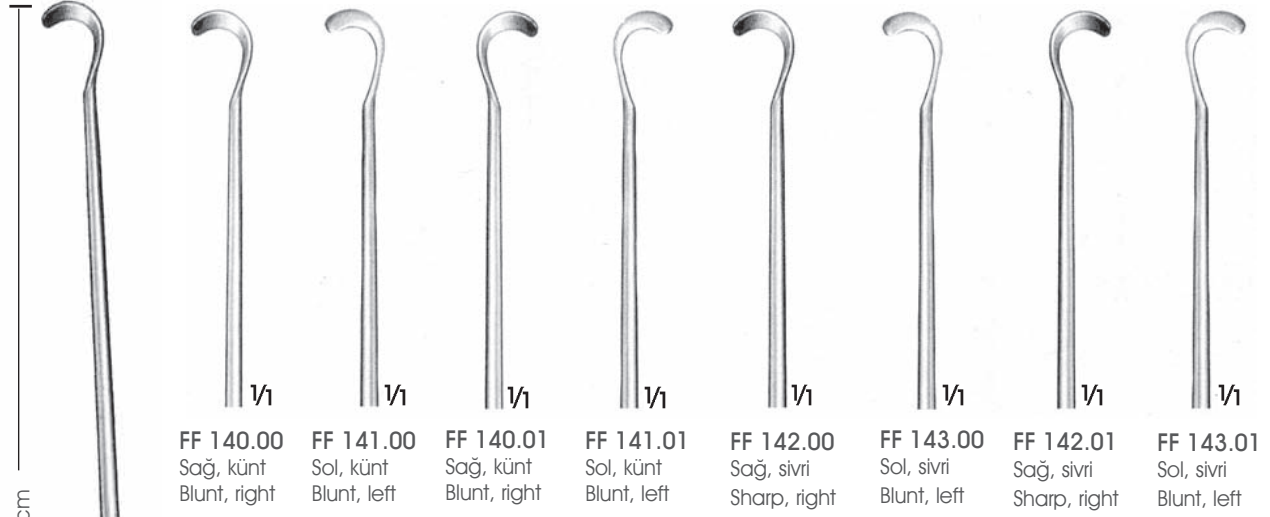

12 cm

HARDY
FF 140.00-FF 143.01
24.5 cm

1/1

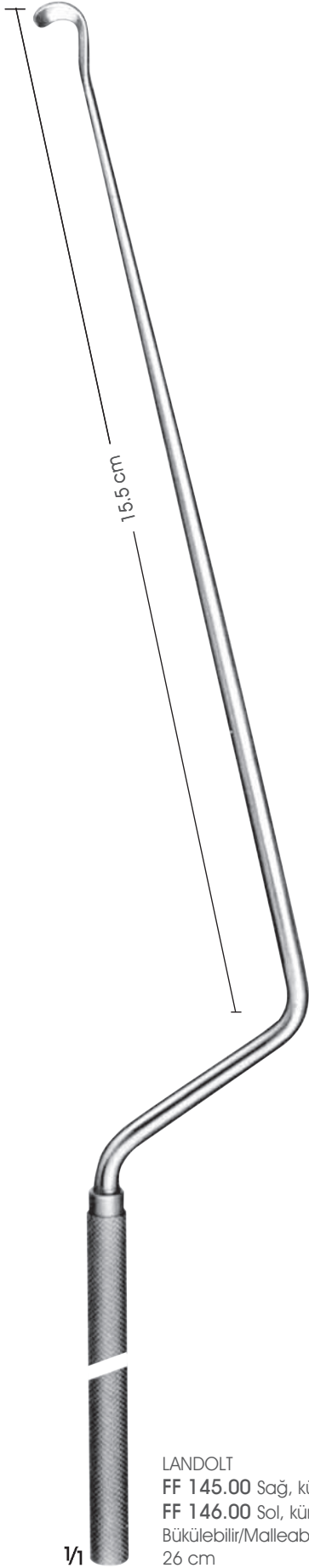

LANDOLT
FF 145.00 Sağ, künt/Blunt, right
FF 146.00 Sol, künt/Blunt, left
Bükülebilir/Malleable
26 cm



LANDOLT
FF 145.01 Sağ, künt
Blunt, right
26 cm
FF 146.01 Sol, künt
Blunt, left
Bükülebilir/Malleable
26 cm



LANDOLT
FF 105.00
Küret, bükülebilir
Curette, malleable
26 cm

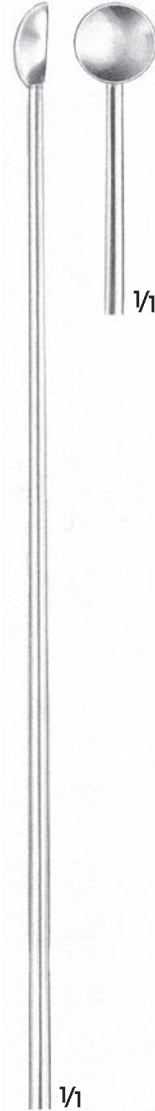

LANDOLT
FF 106.00
Kaşık, bükülebilir
Spoon, malleable
26 cm



LANDOLT
FF 116.00
Künt huk/Blunt hook
Bükülebilir/Malleable
26 cm





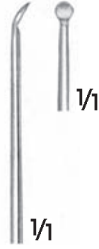
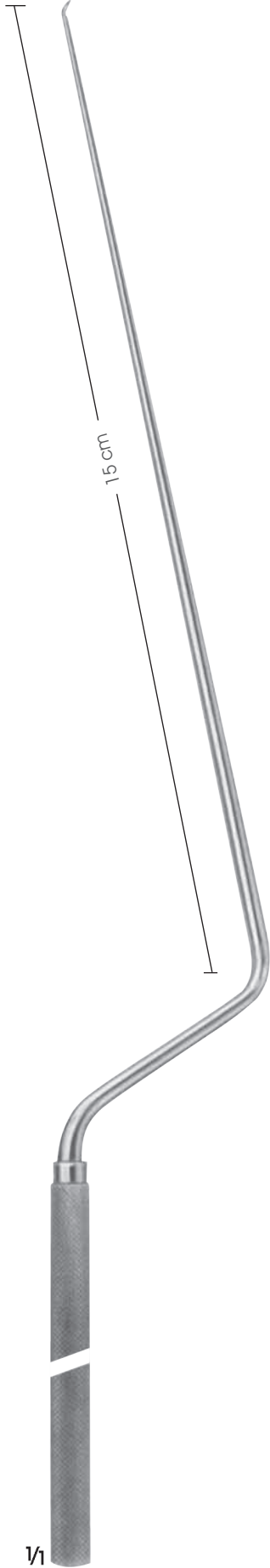

LANDOLT-REULEN
FF 149.00 Ø 2.2 mm
Raspa, esnemez
Raspatories, rigid
26 cm



LANDOLT-REULEN
FF 149.01 Ø 3.2 mm
Raspa, esnemez
Raspatories, rigid
26 cm



LANDOLT-REULEN
FF 109.00 Ø 2.5
mm Küret, esnemez
Curette, rigid
26 cm



LANDOLT-REULEN
FF 115.00 Ø 1.7
mm Künt huk/Blunt
hook 26 cm



FAHLBUSCH
FF 107.00 Ø 2.0
mm Kaşık, bükülebilir
Spoon, malleable
26 cm



FAHLBUSCH
FF 108.00 Ø 2.5
mm Küret, bükülebilir
Curette, malleable
26 cm



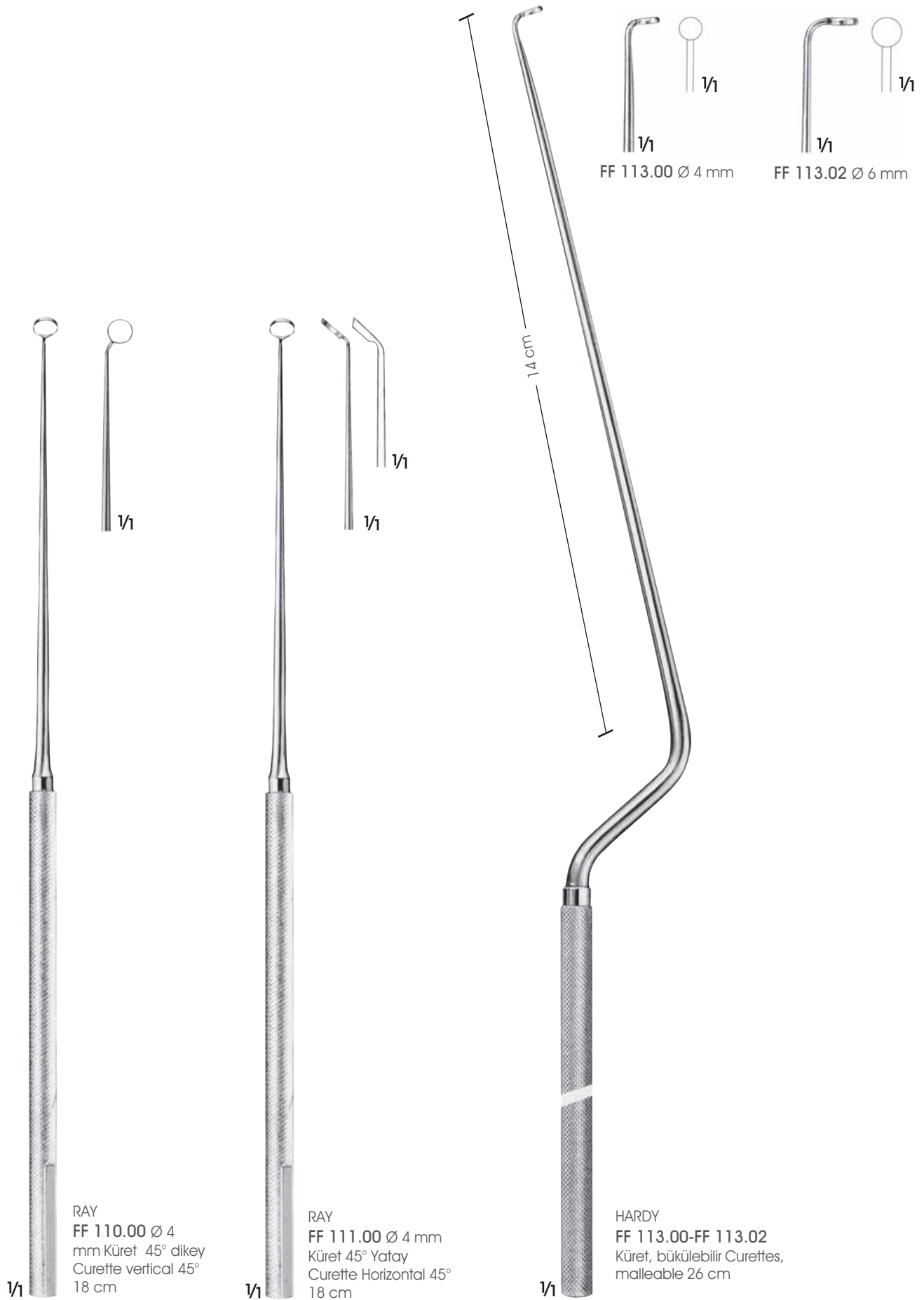

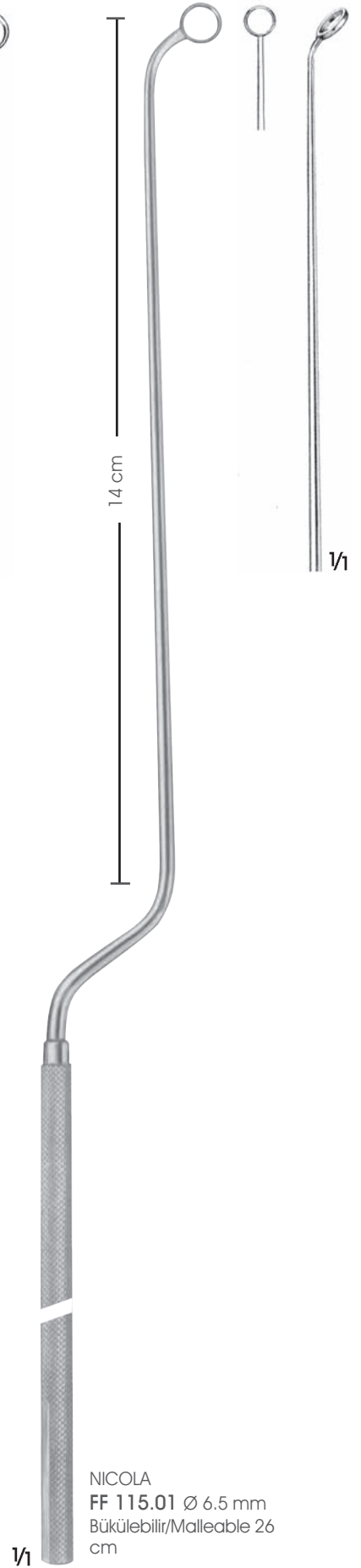
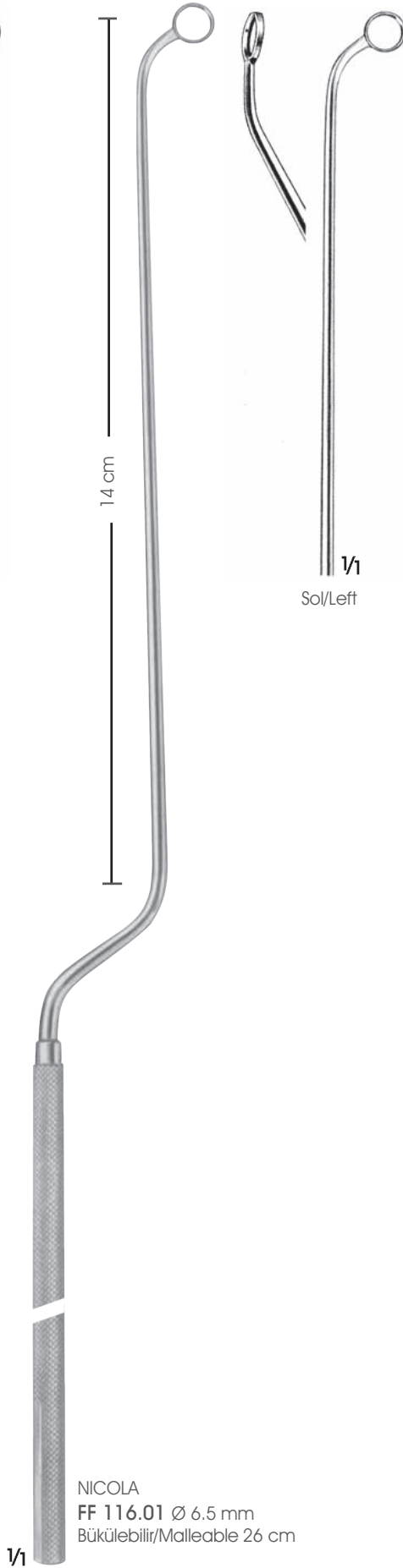
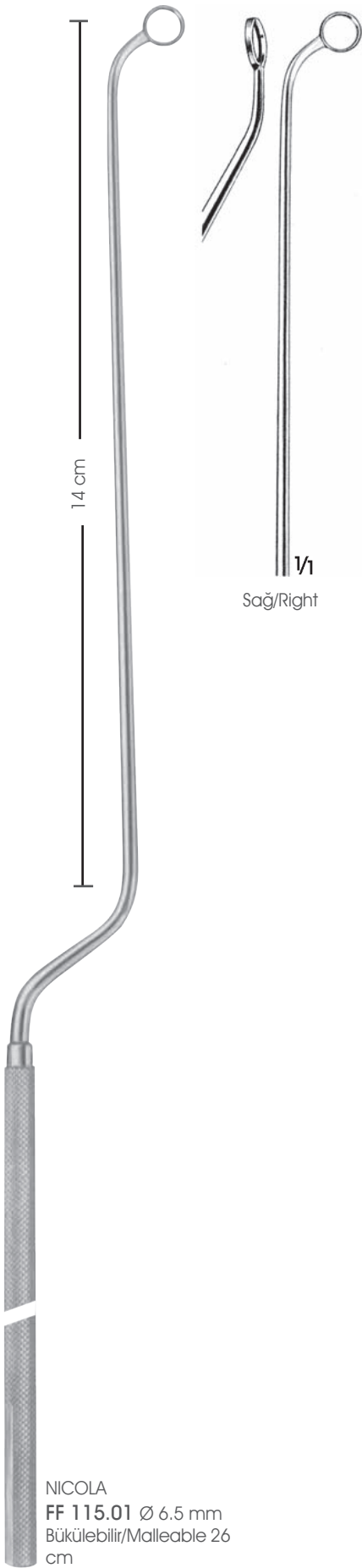



CLOWARD
BV 490.01
Sadece ekartör
Retractor only
25 cm



CLOWARD
BV 491.00
Sadece ekartör
Retractor only
15 cm

CLOWARD
BV 490.00 Komple/Complete
BV 490.01
BV 490.05 - BV 491.09

CLOWARD
BV 491.01
Komple/Complete
BV 491.00
BV 491.05
BV 491.09



BV 490.05



BV 490.06

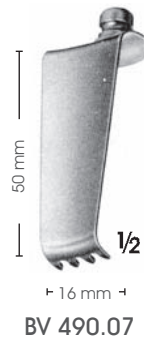

BV 490.07

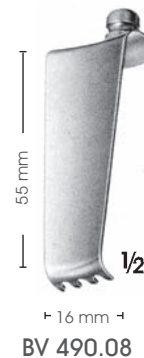

BV 490.08

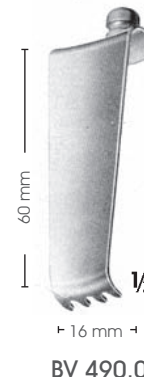

BV 490.09



BV 491.05

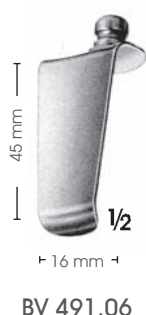

BV 491.06



BV 491.07

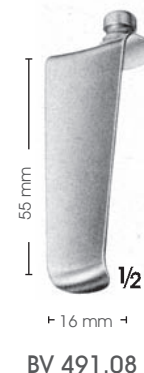

BV 491.08

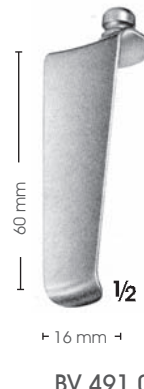

BV 491.09



CLOWARD
BV 494.00
15.5 cm



CLOWARD
BV 495.00
13.5 cm



INGE
BV 497.00
17 cm

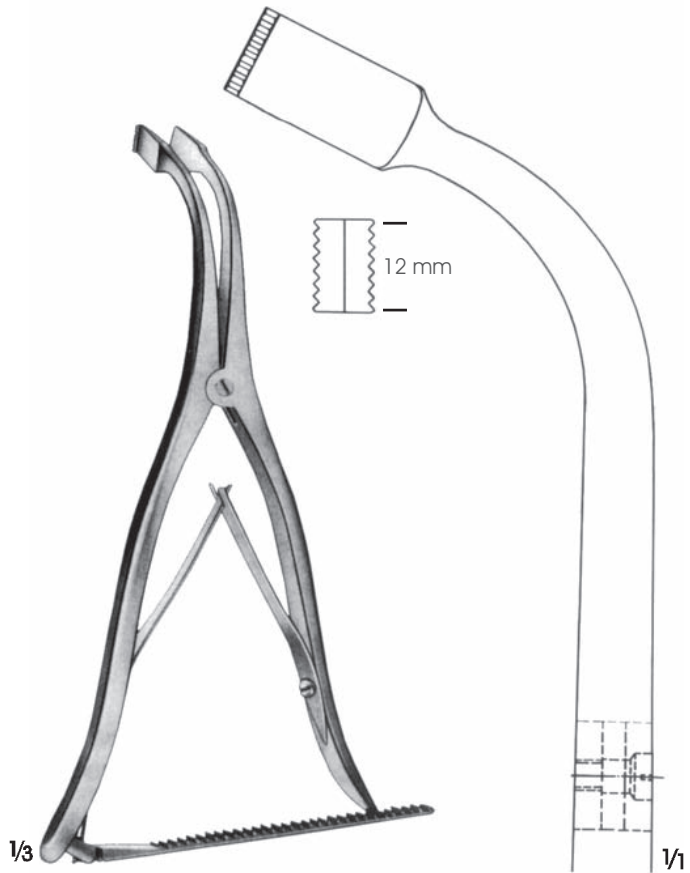

INGE
BV 498.00
27.5 cm





CLOWARD
 MF 552.00 18 mm
 MF 552.01 20 mm
 MF 552.02 23 mm
 18 cm



CLOWARD
 MF 557.00
 Koter huku/Coutery hook
 20 cm



CLOWARD
 MF 555.00
 10 x 8 mm
 19 cm



CLOWARD
 MF 554.00
 20 x 12 mm
 20 cm



1/2
 CLOWARD
 MF 814.01 230
 gr. 19 cm



CLOWARD
 MF 567.00 5 mm
 MF 567.01 8 mm
 MF 567.02 10 mm
 MF 567.04 12 mm 20
 cm



CLOWARD
 MF 569.00
 18 cm



CLOWARD
 MF 568.00
 20 cm

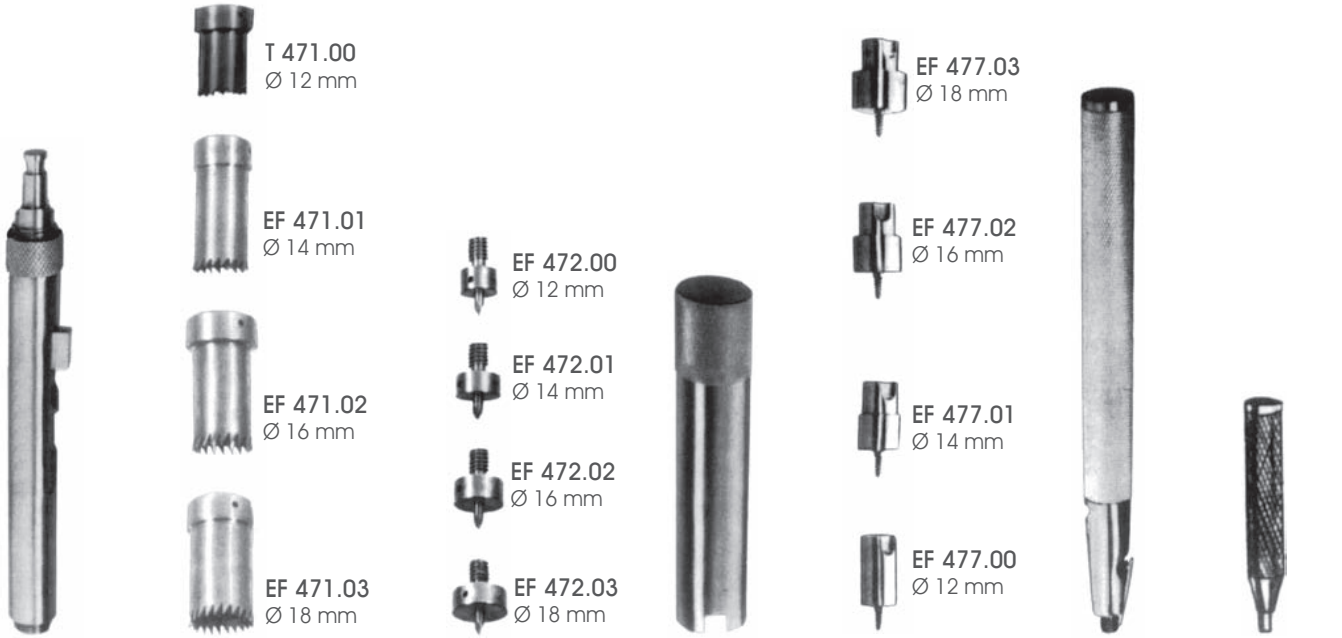

CLOWARD
EF 470.00
Greff alma kolu
Dowel cutter shaft
16.5 cm

EF 471.00-EF 471.03
Greff alma matkapları
Dowel cutters

EF 472.00-EF 472.03
Merkezleme pimleri
Dowel center pins

EF 475.00
Çakma başlığı
Dowel ejector

EF 477.00-EF 477.03
Greff tutma uçları
Dowel holders

EF 478.00
Tutma kolu
Dowel handle

T 479.00
Anahtar
Wrench

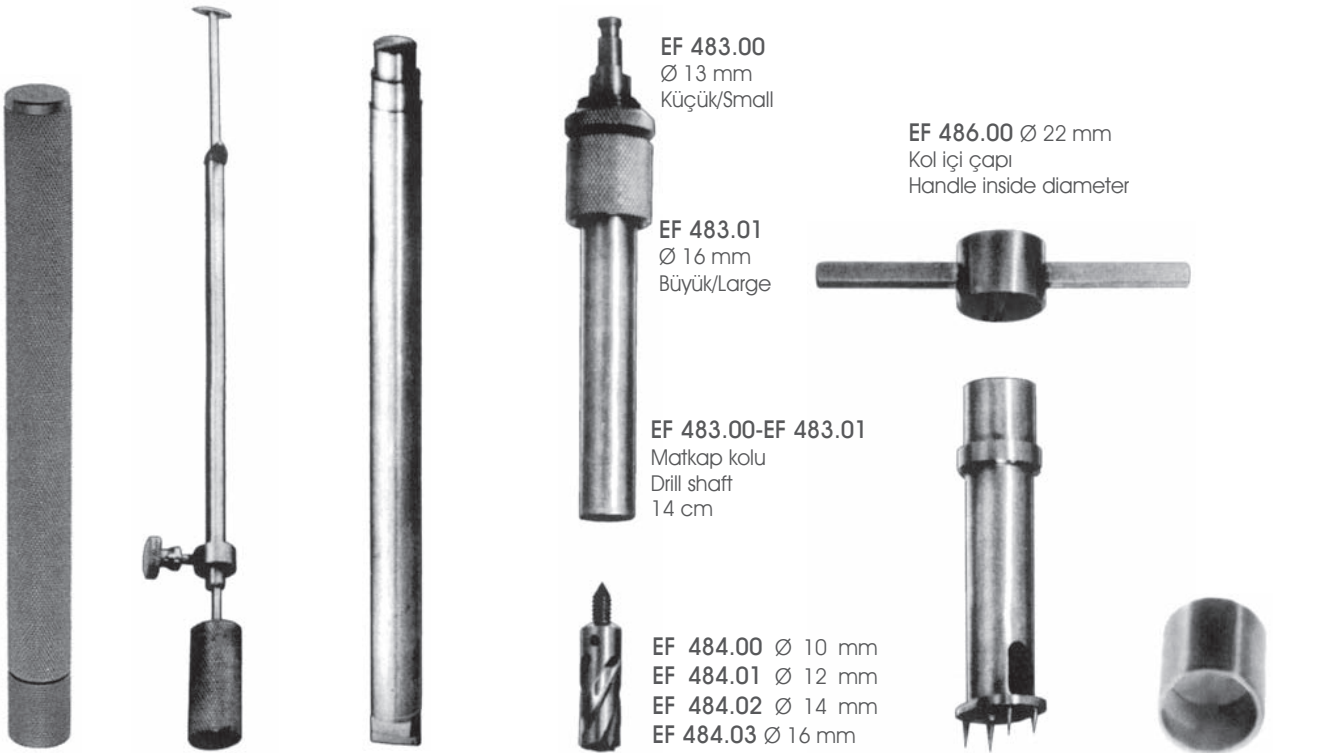

EF 481.00
Tutma kolu
Dowel handle
18 cm

EF 480.01
Derinlik ölçer
Depth gauge
21 cm

EF 482.00 Ø 9.5 mm
EF 482.01 Ø 13 mm
Koruyucu kılavuz
Guard guide
19 cm

EF 484.00-EF 484.03
Matkap ucu/Drill tip

EF 484.00 Ø 10 mm
EF 484.01 Ø 12 mm
EF 484.02 Ø 14 mm
EF 484.03 Ø 16 mm

EF 483.00
Ø 13 mm
Küçük/Small

EF 483.01
Ø 16 mm
Büyük/Large

EF 483.00-EF 483.01
Matkap kolu
Drill shaft
14 cm

EF 486.00 Ø 22 mm
Kol içi çapı
Handle inside diameter

EF 487.00 Ø 13 mm
Küçük/Small
EF 487.01 Ø 16 mm
Büyük/Large Matkap
koruyucu Drill guard

EF 488.00 Ø 25 mm
Matkap koruma başlığı
Drill Guard cap
3 mm

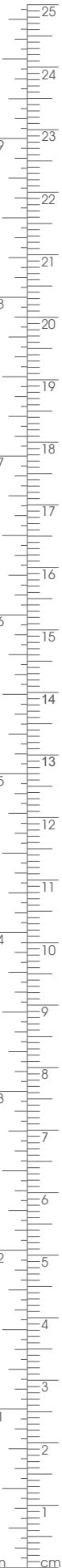



FC 901.00
Sadece ekartör, V 644.00P ile birlikte
Retractor only, with key V 644.00P



TE 644.00P
Tornavida/Screwdriver
15 cm



BV 470.20T 20 x 35 mm
BV 470.21T 20 x 40 mm
BV 470.22T 20 x 45 mm
BV 470.23T 20 x 55 mm
BV 470.24T 20 x 65 mm
Titanyum bleydler Blades
titanium



BV 470.30T 40 x 35 mm
BV 470.31T 40 x 40 mm
BV 470.32T 40 x 45 mm
BV 470.33T 40 x 55 mm
BV 470.34T 40 x 65 mm
BV 470.35T 40 x 75 mm
Titanyum bleydler Blades
titanium

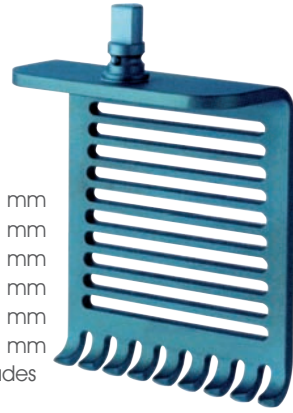

BV 470.40T 60 x 35 mm
BV 470.41T 60 x 40 mm
BV 470.42T 60 x 45 mm
BV 470.43T 60 x 55 mm
BV 470.44T 60 x 65 mm
BV 470.45T 60 x 75 mm
BV 470.46T 60 x 85 mm
Titanyum bleydler Blades
titanium



BV 463.50T
Hemi-Laminektomi huk, küçük 38 mm
Hemi-Laminectomy hook, small 38 mm



BV 463.52T
Hemi-Laminektomi huk, büyük 58 mm
Hemi-Laminectomy hook, large 58 mm



FH 995.00P
Ekartör bleydleri yerleştirme kolu
Handle for positioning of the
retractor blades

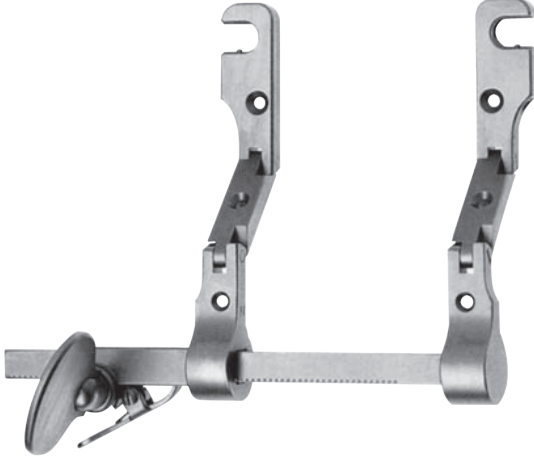

BV 465.05
Çift hareketli Servikal ekartör
Doble hinged Cervical retractor



BV 469.05
Çift hareketli karşı ekartör
Doble hinged retractor used for
longitudinal retraction



BV 467.05
Karşı ekartör
Counter retractor

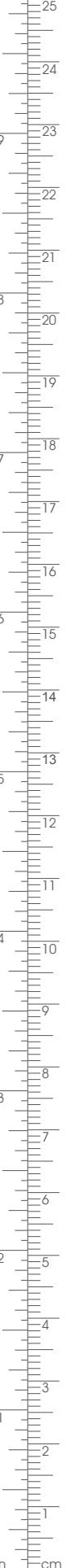

BV 470.50T 30 x 24 mm
BV 470.51T 35 x 24 mm
BV 470.52T 40 x 24 mm
BV 470.53T 45 x 24 mm
BV 470.54T 50 x 24 mm
BV 470.55T 55 x 24 mm
BV 470.56T 60 x 24 mm
BV 470.57T 65 x 24 mm
BV 470.58T 70 x 24 mm
Titanyum orta bleydler
Mediall blades titanium



BV 471.50T 30 x 24 mm
BV 471.51T 35 x 24 mm
BV 471.52T 40 x 24 mm
BV 471.53T 45 x 24 mm
BV 471.54T 50 x 24 mm
BV 471.55T 55 x 24 mm
BV 471.56T 60 x 24 mm
BV 471.57T 65 x 24 mm
BV 471.58T 70 x 24 mm
Titanyum yan bleydler
Lateral blades titanium



BV 472.50T 35 x 24 mm
BV 472.51T 40 x 24 mm
BV 472.52T 45 x 24 mm
BV 472.53T 50 x 24 mm
BV 472.54T 55 x 24 mm
BV 472.55T 60 x 24 mm
BV 472.56T 65 x 24 mm
BV 472.57T 70 x 24 mm
BV 472.58T 75 x 24 mm
Titanyum künt bleydler
Blunt blades titanium



BV 474.50T 30 x 24 mm
BV 474.51T 35 x 24 mm
BV 474.52T 40 x 24 mm
BV 474.53T 45 x 24 mm
BV 474.54T 50 x 24 mm
BV 474.55T 55 x 24 mm
BV 474.56T 60 x 24 mm
BV 474.57T 65 x 24 mm
BV 474.58T 70 x 24 mm
Titanyum orta bleydler
Mediall blades titanium



BV 473.50T 30 x 24 mm
BV 473.51T 35 x 24 mm
BV 473.52T 40 x 24 mm
BV 473.53T 45 x 24 mm
BV 473.54T 50 x 24 mm
BV 473.55T 55 x 24 mm
BV 473.56T 60 x 24 mm
BV 473.57T 65 x 24 mm
BV 473.58T 70 x 24 mm
Titanyum yan bleydler
Lateral blades titanium



BV 475.50T 35 x 24 mm
BV 475.51T 40 x 24 mm
BV 475.52T 45 x 24 mm
BV 475.53T 50 x 24 mm
BV 475.54T 55 x 24 mm
BV 475.55T 60 x 24 mm
BV 475.56T 65 x 24 mm
BV 475.57T 70 x 24 mm
BV 475.58T 75 x 24 mm
Titanyum künt bleydler
Blunt blades titanium



BV 476.50T 25 x 19 mm
BV 476.51T 30 x 19 mm
BV 476.52T 35 x 19 mm
BV 476.53T 40 x 19 mm
BV 476.54T 45 x 19 mm
BV 476.55T 50 x 19 mm
BV 476.56T 55 x 19 mm
BV 476.57T 60 x 19 mm
Titanyum dişli bleydler
Teeth blades titanium



BV 477.50T 25 x 19 mm
BV 477.51T 30 x 19 mm
BV 477.52T 35 x 19 mm
BV 477.53T 40 x 19 mm
BV 477.54T 45 x 19 mm
BV 477.55T 50 x 19 mm
BV 477.56T 55 x 19 mm
BV 477.57T 60 x 19 mm
Titanyum künt bleydler
Blunt blades titanium



FH 995.00P
Bleyd tutucu elçek
Handle for blades with side load
attachment

LX

Ortopedik Cerrahi
Orthophedic Surgery



 ARGENT

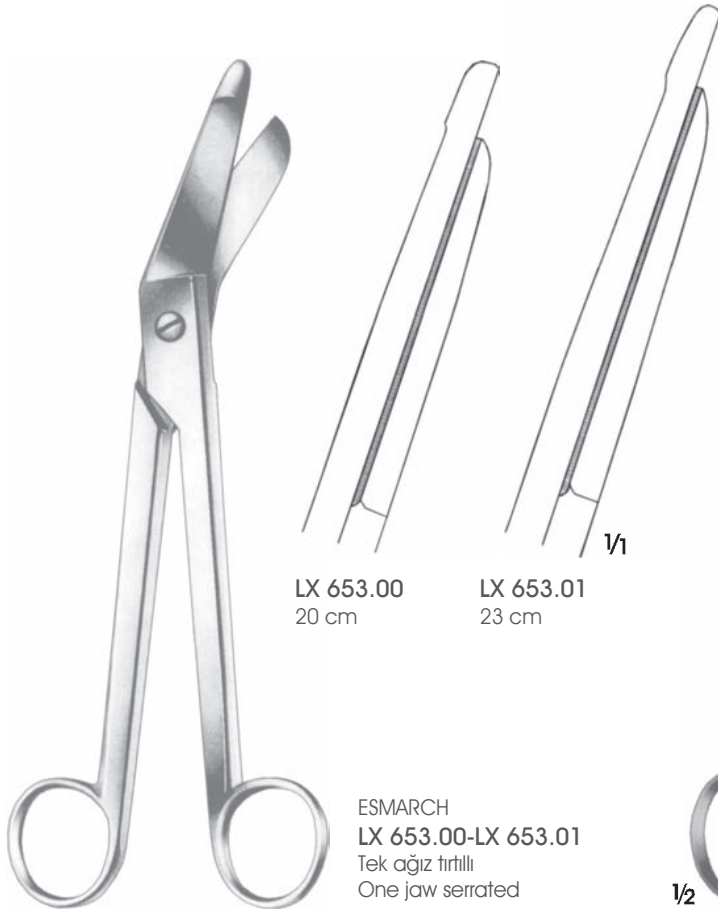



ESMARCH
AA 175.00
Alçı bıçağı
Plaster knife
18 cm

1/2



ENGEL
LX 605.00
Alçı testeresi
Plaster saw
15 cm

1/2

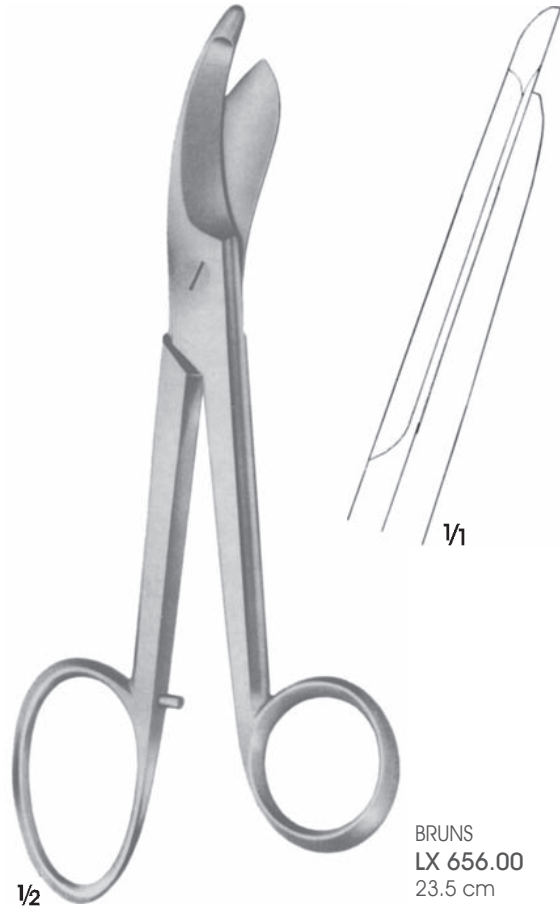

BRUNS
LX 656.00
Tek ağız tırtıllı
One jaw serrated
23.5 cm

1/2

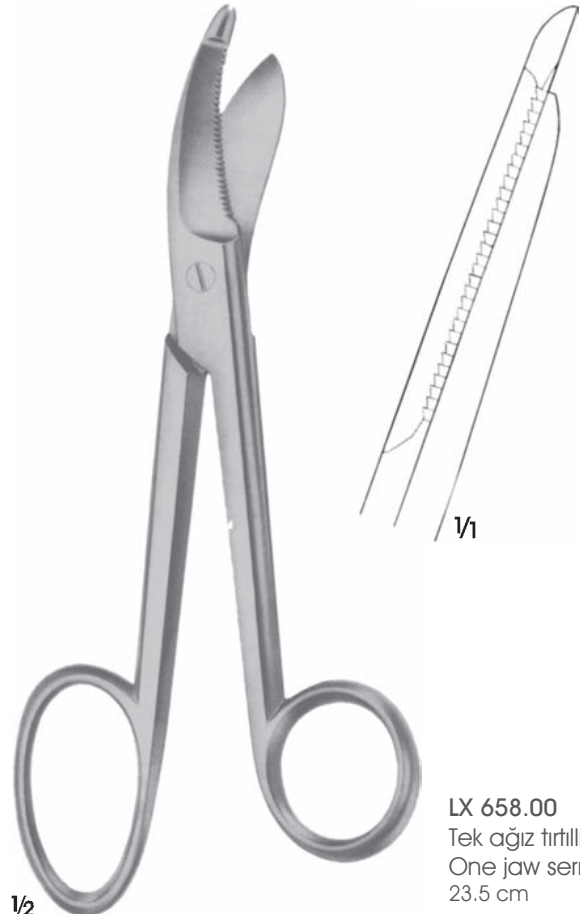

LX 658.00
Tek ağız tırtıllı
One jaw serrated
23.5 cm

1/2

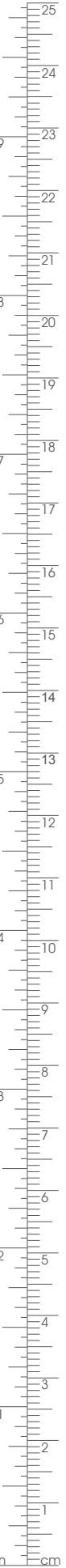



1/3

STILLE
BC 882.00
23 cm



1/3

STILLE
BC 884.00
26 cm



1/3

STILLE
BC 885.00
36 cm



1/3

STILLE
BC 886.00
37 cm



1/3

LX 600.00
Alçı ayırıcı
Plaster shear
23 cm



1/3

HENNIG
LX 602.00
Alçı ayırıcı
Plaster shear
27 cm



WOLFF
LX 608.00 18 cm
LX 608.02 24 cm
Alçı kesiciler Plaster
breakers



1/3

LX 605.00
Alçı ayırıcı
Plaster shear
29 cm

Sökülebilir çeneli
With removable jaws



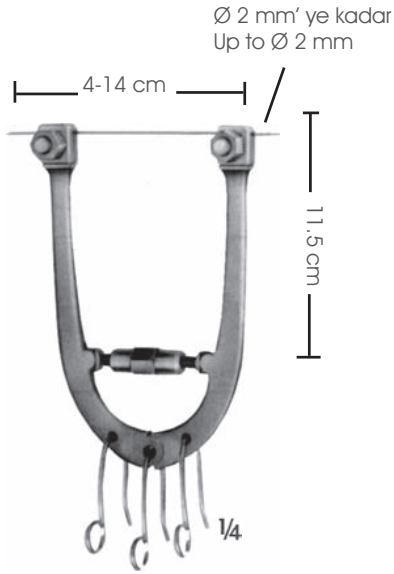

LX 550.00

Ayarlı küçük boy, üç kancalı traksiyon aleti
Wire traction bow, adjustable, with 3 hooks,
small size
LX 558.00 Uygun anahtar
LX 558.00 Suitable wrench

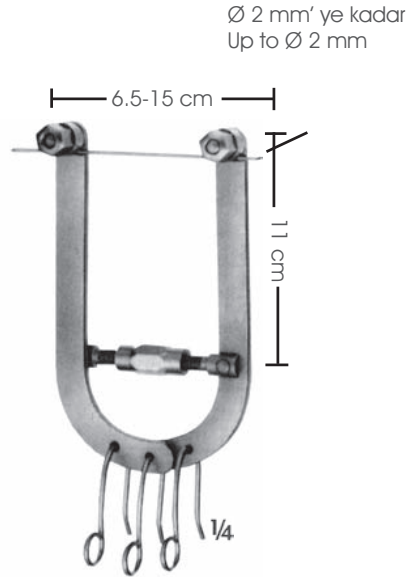

LX 551.00

Ayarlı küçük boy, üç kancalı traksiyon aleti
Wire traction bow, adjustable, with 3 hooks,
small size
LX 558.00 uygun anahtar
LX 558.00 suitable wrench

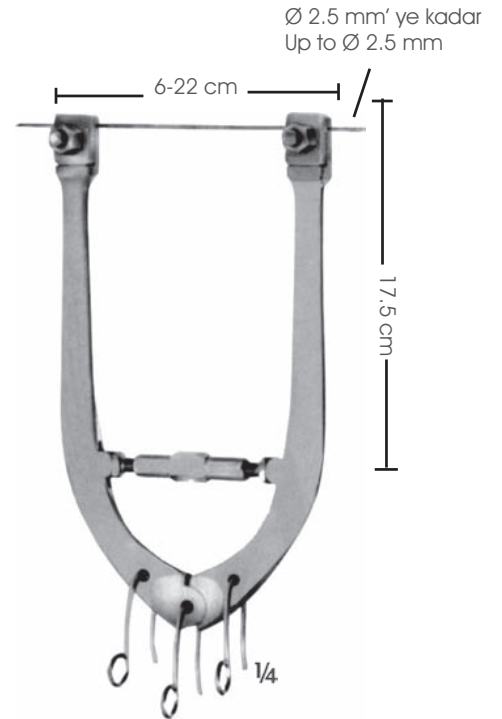

LX 550.01

Ayarlı büyük boy, üç kancalı traksiyon aleti
Wire traction bow, adjustable, with 3 hooks,
large size
LX 558.00 Uygun anahtar
LX 558.00 Suitable wrench

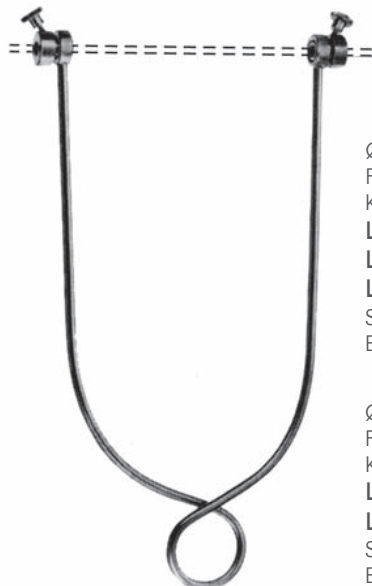

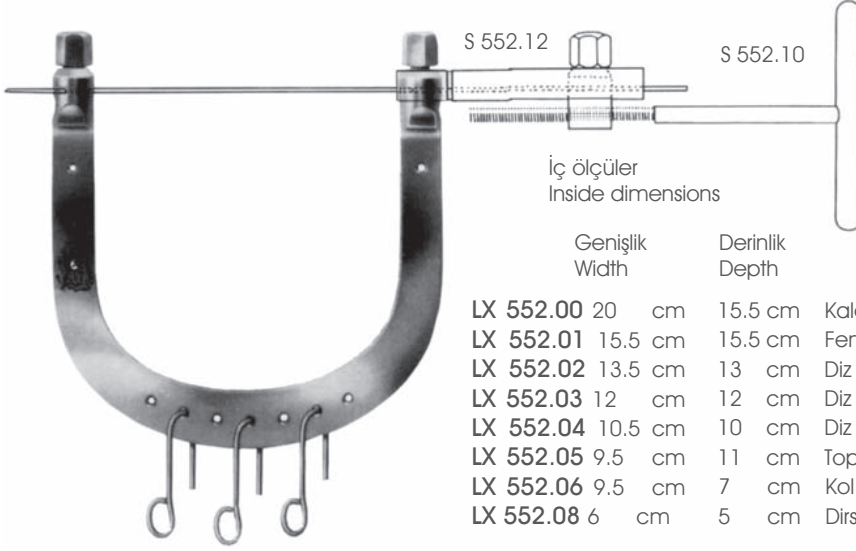

KIRSCHNER
LX 552.00-S 552.06
3 kancalı, Ø 2.5 mm'ye kadar KIRSCHNER
teli ile kullanılan çekirme
Wire traction bows, to be used with KIRSCHNER
wires up to Ø 2.5 mm, with 3 hooks

İç ölçüler
Inside dimensions

	Genişlik Width	Derinlik Depth	
LX 552.00	20 cm	15.5 cm	Kalça için/For the hip
LX 552.01	15.5 cm	15.5 cm	Femur için/For the femur
LX 552.02	13.5 cm	13 cm	Diz için/For the knee
LX 552.03	12 cm	12 cm	Diz için/For the knee
LX 552.04	10.5 cm	10 cm	Diz için/For the knee
LX 552.05	9.5 cm	11 cm	Topuk için/For the calcaneus
LX 552.06	9.5 cm	7 cm	Kol ve dirsek için/For the arm and elbow
LX 552.08	6 cm	5 cm	Dirsek için, çocuklar için/For the elbow child size



LX 552.10
Kavrama çeneli tel gerdirme aleti
Wire tightener with clamping jaws



LX 552.12
LX 552.10 Tespit klempini için/For fixation
clamp



LX 558.00
Traksiyon yayı anahtarı Wrench,
double-ended, for wire traction bows
LX 552.00-LX 551.00



LX 555.00
Büyük boy traksiyon kancası
Large size traction hook



LX 555.01
Küçük boy traksiyon kancası
Small size traction hook



LX 557.00 Sabitleme
diski kanallı Fixation
disc, slotted



LX 557.01
Alüminyum, x ışınlarını
geçirgen
Fixation disc, slotted idem,
alüminyum transparent to
X-rays



LX 557.02 Sabitleme
diski, kanallı
Fixation disc, slotted

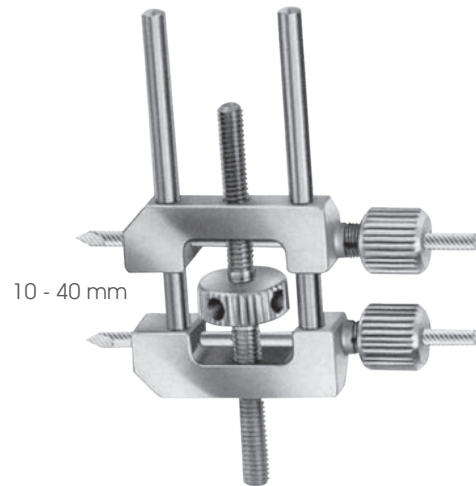

LX 380.00
Küçük distraktör
Small distractor
Tel Ø 3.0 mm
For wires Ø 3.0 mm

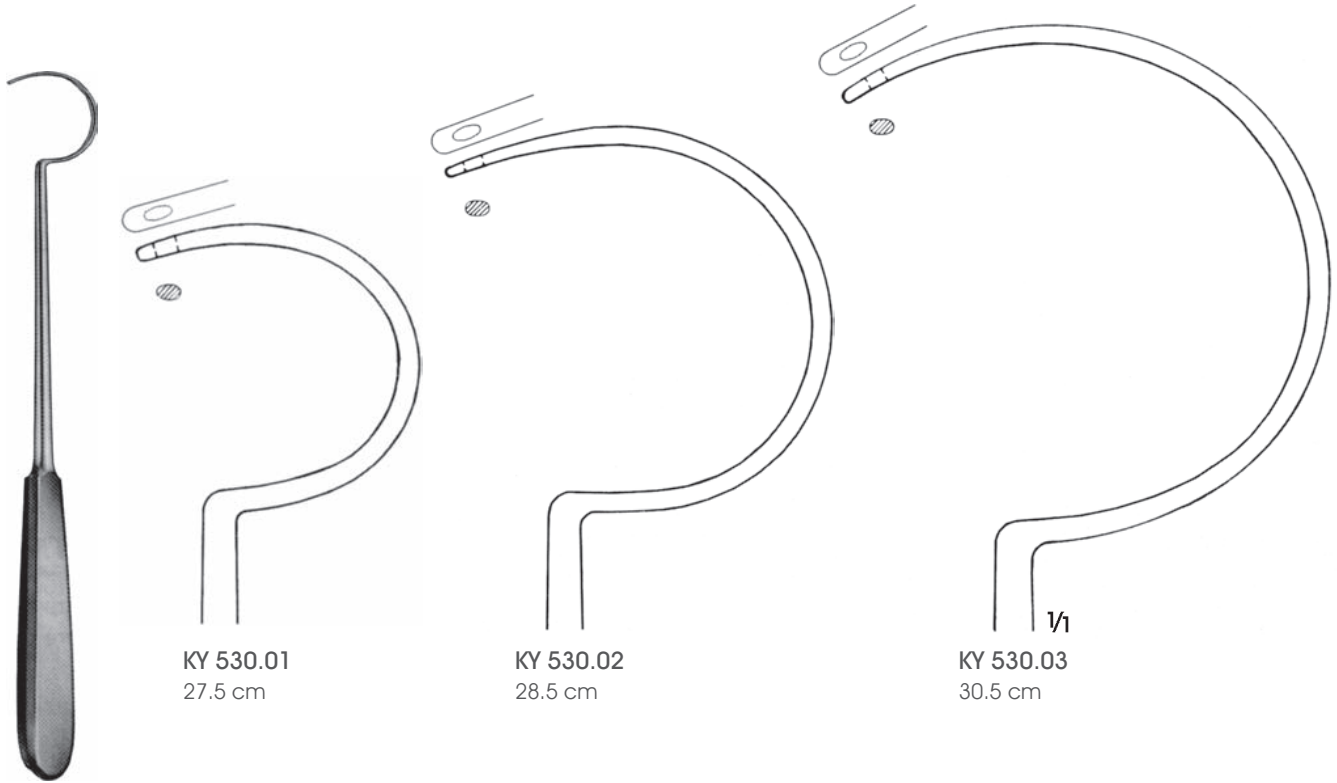

DEMEL
KY 530.01-KY 530.03
Tel kılavuzları/Wire guides

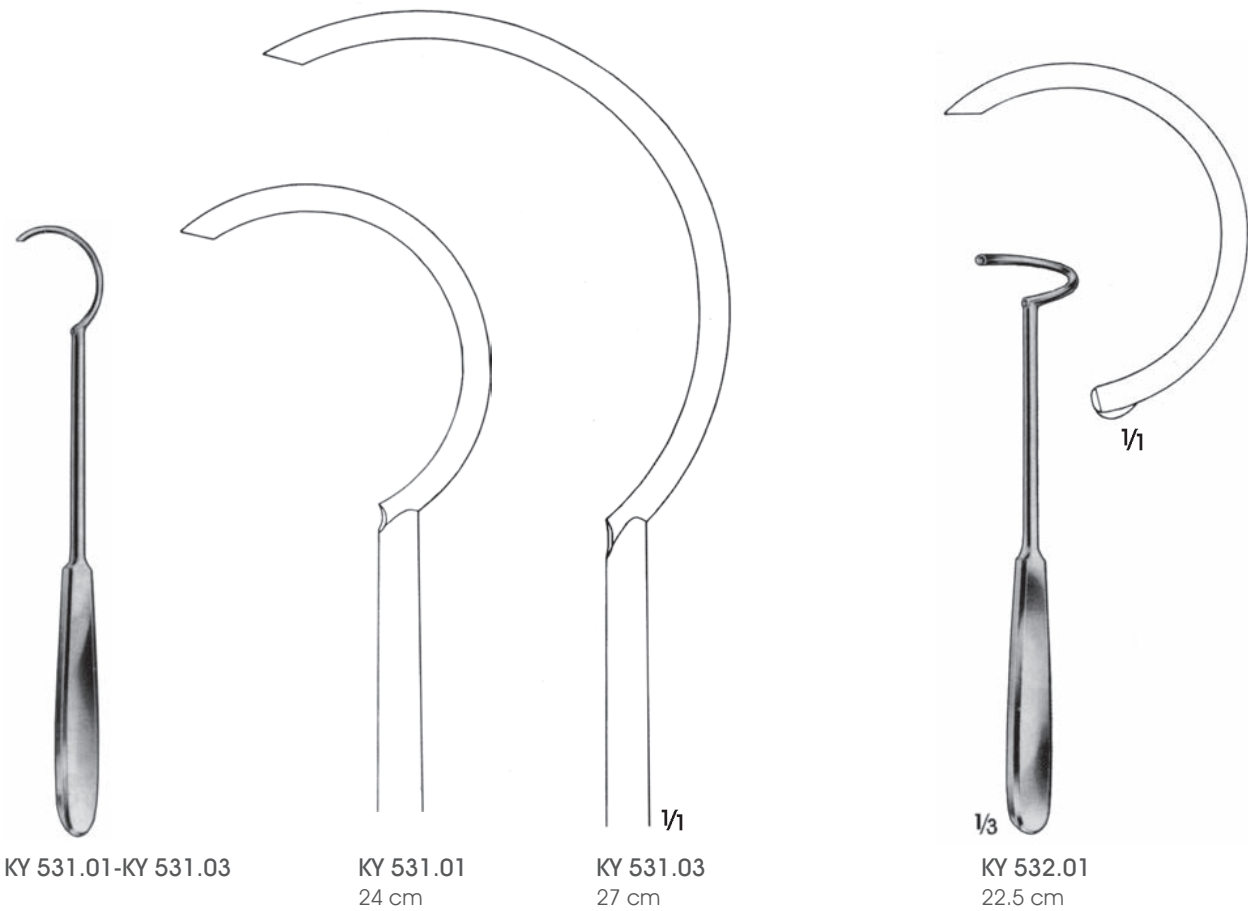



KY 529.00 Ø 0.2 mm KY 529.03 Ø 0.5 mm KY 529.06 Ø 0.8 mm KY 529.09 Ø 1.2 mm
KY 529.01 Ø 0.3 mm 529.04 Ø 0.6 mm KY 529.07 Ø 0.9 mm KY 529.10 Ø 1.5 mm
KY 529.02 Ø 0.4 mm 529.05 Ø 0.7 mm KY 529.08 Ø 1.0 mm

KY 529.00-KY 529.10

Yumuşak doku uyumlu tel 10 m
Wire, soft, tissue compatible, in coils of 10 m

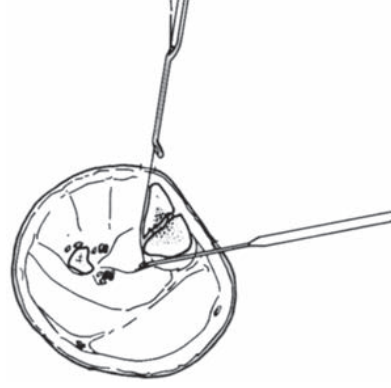
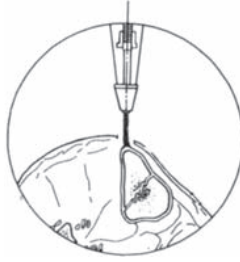

Implantlar için kullanılan malzemeden yapılmış hareketli uç. Bükülürken hareketli başlık sabit kalır bu sayede tel kalmaz.
Movable tip made of material used for implants. While twisting the movable head remains stable, therefore the wire will not slip off.

1/2

**LOUTE
KY 520.00**

Tel gerici, geliştirilmiş model, hareketli uç ile 1.0 mm çapına kadar olan teller için
Wire tightener, improved pattern, with movable tip, for wires up to 1.0 mm diam
22 cm

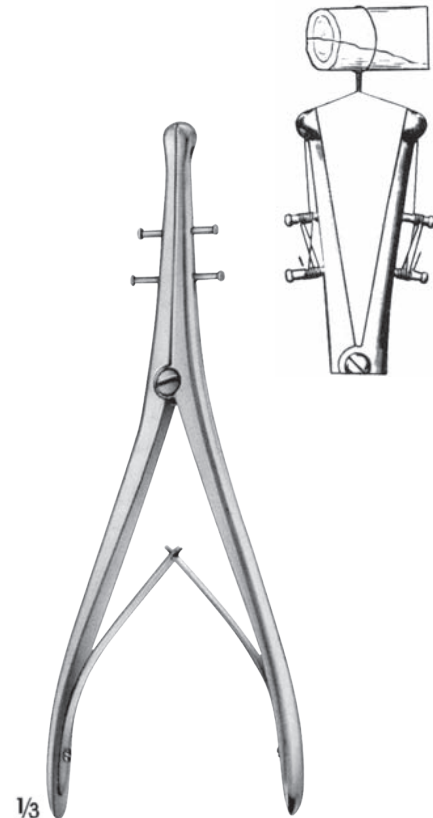

1/3

**DEMEL
KY 522.00**

Gerdirek tel sıkma, büküm pensi
Wire tightening-and twisting forceps
27 cm



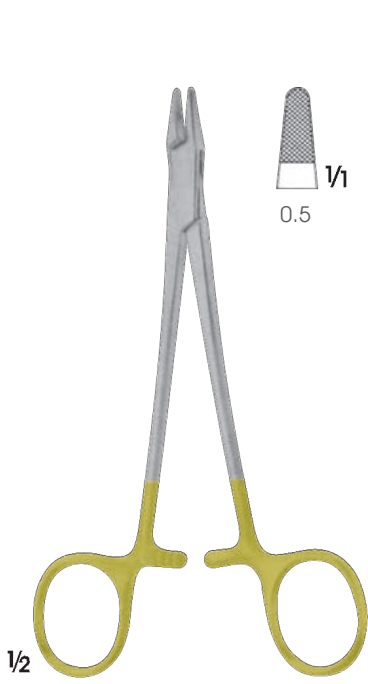

BM 334.00
Tel bükücü/Wire twister
Bağlama pens/Ligature forceps
15 cm



BM 336.00
Tel bükücü/Wire twister
Bağlama pens/Ligature forceps
15 cm

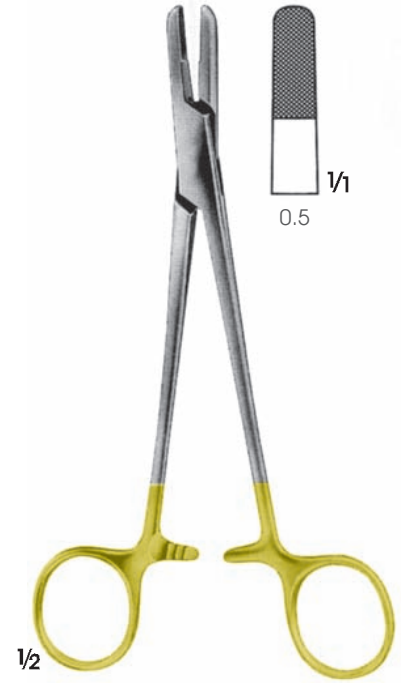

BM 337.01
Sternum dikişi için
For sternum suture
17.5 cm



**BERRY
MD 335.00**
Tel bükücü/Wire twister
Bağlama pens/Ligature forceps
18.5 cm



**BAUMGARTNER
BM 339.01**
Tel bükücü/Wire twister
Bağlama pens/Ligature forceps
20 cm



LX 610.00
17 cm

Kaymayı engellemek için
yanal çeneleri olan serkaj teli
tutma Pensi
Holding forceps for cerclage wire,
with lateral jaws to avoid
wire slipping off



**MARBURG MODELL
DP 611.00**
Tel tutma pensi,
Düz burunlu, tırtıllı ağız
Wire holding forceps,
Flat nosed, with serrated jaws
14 cm



**GOSLEE
DP 617.00**
Tel bükücü, düz burunlu
Wire twister, flat nosed
14 cm

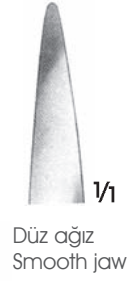

Düz ağız
Smooth jaw

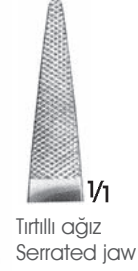

Tırtıllı ağız
Serrated jaw



LX 612.00-LX 613.00
Tel bükücü, düz burunlu
Wire twister, flat nosed
17 cm



LX 612.00
Tırtıllı ağız
With serrated jaws

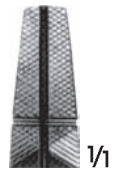

LX 613.00
Boylamasına ve
çapraz kanallı
With longitudinal
and transversal
grooves



MB 627.00
19.5 cm



LX 614.00
Tel tutma pensi, düz burunlu
Wire holding forceps, flat nosed
19 cm



LX 615.00-LX 616.00
Tel çıkarma pensi
Extraction pliers for boring
wires



LX 615.00
13 cm

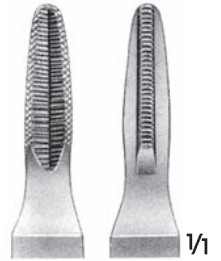

LX 616.00
18 cm



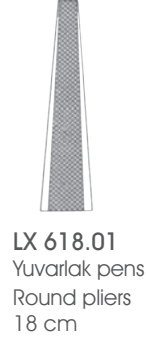

LX 618.01
Yuvarlak pens
Round pliers
18 cm



LX 618.02
Tel çıkartıcı pens
Extraction pliers
for wires
18 cm

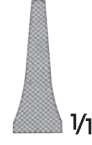

LX 618.05
Tel çıkartıcı pens
Extraction pliers for
wires
14.5 cm

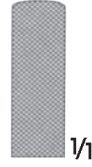

LX 618.03
Tel çıkartıcı pens
Extraction pliers for
wires
18 cm



LX 620.00
Ø 1.8 mm kadar teller için
bükme pensi
Bending pliers for wires up to
1.8 mm diam.



LX 621.00
Paralel düz tutucu
Flat-nosed pliers, parallel
18.5 cm

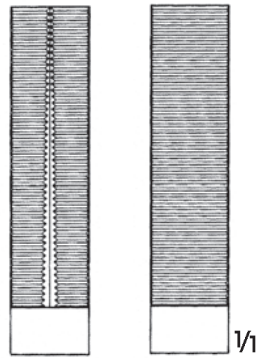

1/1



LX 625.00
Mengene kavramalı, ayarlı pense
Vise grip pliers set
20 cm



1/1



Özel sertleştirilmiş kesici ağız
Specially hardened cutting edges



Özel sertleştirilmiş kesici ağız
Specially hardened cutting edges



Yumuşak tel için Ø 0.5 mm
For soft wire Ø 0.5 mm
Sert tel için Ø 0.3 mm
For hard wire Ø 0.3 mm

1/2

ANGLE
DP 630.00
13 cm



Yumuşak tel için Ø 0.6 mm
For soft wire Ø 0.6 mm
Sert tel için Ø 0.4 mm
For hard wire Ø 0.4 mm

1/2

DP 630.01
13 cm

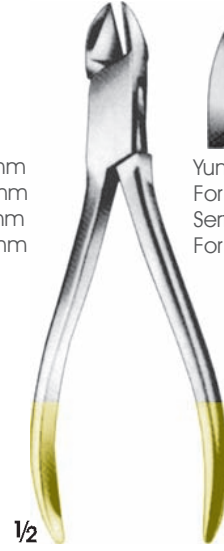

Yumuşak tel için Ø 1.5 mm
For soft wire Ø 1.5 mm
Sert tel için Ø 1.0 mm
For hard wire Ø 1.0 mm

1/2

DP 632.00
Tel kesme pensisi
Wire cutting pliers
14 cm



Sert metal kesici ağız
Tungsten carbide cutting edges

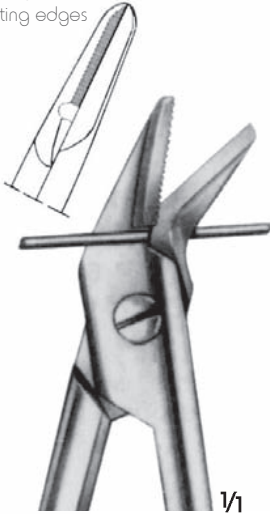

Yumuşak tel için Ø 1.2 mm
For soft wire Ø 1.2 mm
Sert tel için Ø 0.8 mm
For hard wire Ø 0.8 mm

1/2

BC 798.00
Tek ağız tırtıllı
One jaw serrated
12 cm

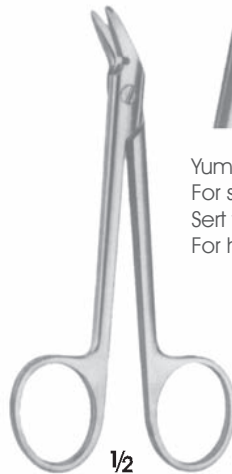

Yumuşak tel için Ø 1.2 mm
For soft wire Ø 1.2 mm
Sert tel için Ø 0.6 mm
For hard wire Ø 0.6 mm

1/2

DP 668.00
Tek ağız tırtıllı
One jaw serrated
12 cm

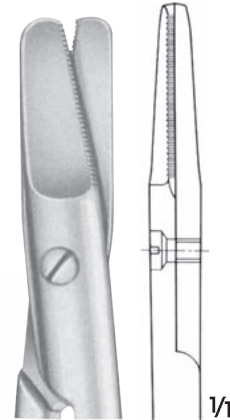
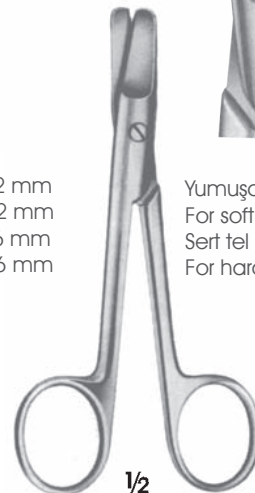

Yumuşak tel için Ø 0.4 mm
For soft wire Ø 0.4 mm
Sert tel için Ø 0.3 mm
For hard wire Ø 0.3 mm

1/2

HARVEY
BC 666.00
Çift ağız tırtıllı
Both jaws serrated
12.5 cm





Özel sertleştirilmiş kesici ağız
Specially hardened cutting edges



1/1

Yumuşak tel için Ø 1.5 mm
For soft wire Ø 1.5 mm
Sert tel için Ø 1.2 mm
For hard wire Ø 1.2 mm

1/2

DP 635.00
16 cm



1/1

Yumuşak tel için Ø 1.5 mm
For soft wire Ø 1.5 mm
Sert tel için Ø 1.0 mm
For hard wire Ø 1.0 mm

1/2

DP 634.00
15 cm

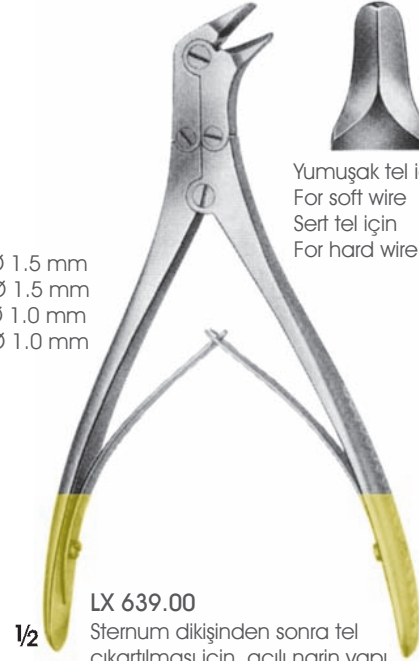

1/1

Yumuşak tel için Ø 0.9 mm
For soft wire Ø 0.9 mm
Sert tel için -
For hard wire -

1/2

LX 639.00
Sternum dikişinden sonra tel
çıkartılması için açılı narin yapı
Angled slender pattern for wire
removal after sternum suture
17 cm



Özel sertleştirilmiş kesici ağız
Specially hardened cutting edges



1/1

Yumuşak tel için Ø 3.0 mm
For soft wire Ø 3.0 mm
Sert tel için Ø 2.2 mm
For hard wire Ø 2.2 mm

1/2

HARVEY
LX 649.05
Tel kesme pens
Wire cutting pliers
23 cm



1/1

Yumuşak tel için Ø 3.0 mm
For soft wire Ø 3.0 mm
Sert tel için Ø 2.2 mm
For hard wire Ø 2.2 mm

1/2

LX 643.00
Yanal kesme
Lateral cutting
23.5 cm



Özel sertleştirilmiş kesici ağız
Specially hardened cutting edges



Yumuşak tel için Ø 2.0 mm
For soft wire Ø 2.0 mm
Sert tel için Ø 1.5 mm
For hard wire Ø 1.5 mm

REILL
LX 640.00
Kemiğe yakın olan
telleri kesme
For cutting off wires close
to the bone
17.5 cm



Yumuşak tel için Ø 2.0 mm
For soft wire Ø 2.0 mm
Sert tel için Ø 1.5 mm
For hard wire Ø 1.5 mm

LX 641.00
Tel kesiciler, ön ve yan kesme
hareketli
Wire cutters, front-and lateral
cutting action
18 cm



Özel sertleştirilmiş kesici ağız
Specially hardened cutting edges



Yumuşak tel için Ø 3.0 mm
For soft wire Ø 3.0 mm
Sert tel için Ø 2.2 mm
For hard wire Ø 2.2 mm

HARVEY
LX 649.00
Tel kesme pensi
Wire cutting pliers
23.5 cm



Sert metal kesici ağız
Tungsten carbide cutting edges



Yumuşak tel için Ø 2.5 mm
For soft wire Ø 2.5 mm
Sert tel için Ø 2.0 mm
For hard wire Ø 2.0 mm

LX 645.00
Tel kesme pensi
Wire cutting pliers
24 cm





LX 647.00
14.5 cm



DP 650.00
14.5 cm



LX 651.00
16.5 cm

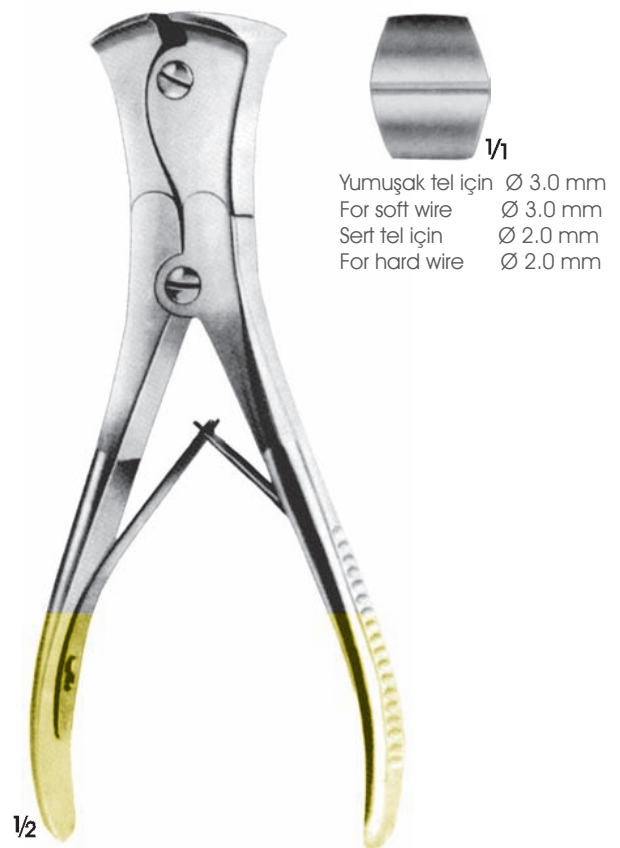

LX 648.00
22 cm



LX 652.00
Ø 3 mm kadar tel, vida, çivi vs. kesmek için
For cutting off wires, screws, pins, etc. up to Ø 3 mm
32 cm



LX 655.00
Ø 6 mm kadar tel, vida, çivi vs. kesmek için
For cutting off wires, screws, pins, etc. up to Ø 6 mm
47 cm

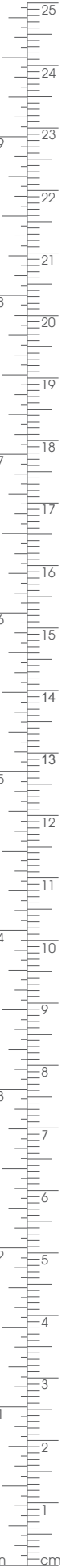

143° buhar sterilizatörlerinde steril edilebilir.
Can be sterilized in a steam sterilizer up to 143°



1/2
OBWEGESER
DO 458.00
19.5 cm

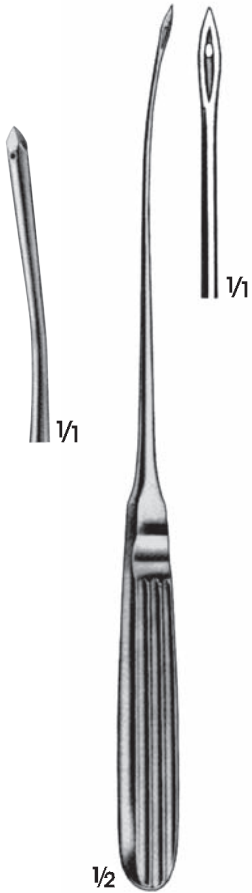

1/2
OBWEGESER
DO 457.00
23 cm

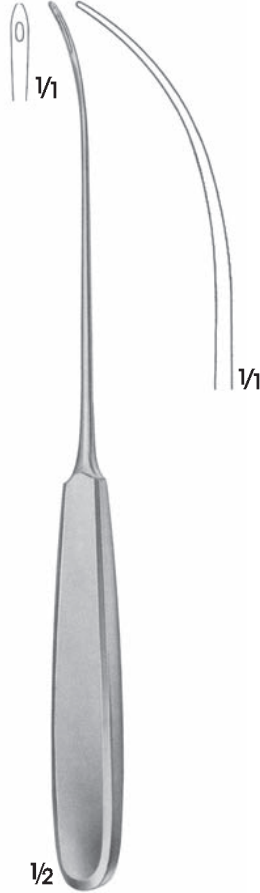

1/2
BM 460.00
Bükülebilir/Malleable
23 cm

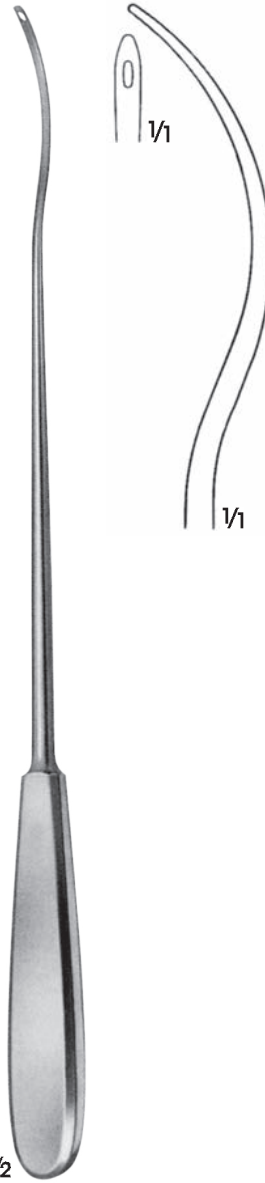

1/2
BRUNNER
BM 466.00
30 cm



1/2
WAGNER
KY 533.00
Tel uzatma/Wire extension
30 cm



1/2

FR 600.00
Oyucu (Biz)
Reamer (Awl)
18 cm



1/2

FR 601.00
Oyucu (Biz)
Reamer (Awl)
21.5 cm



1/2

CHAMPIONNIERE
LX 607.00
Kemik matkabı
Bone drill
17 cm



1/2

FR 599.00
Oyucu (Biz)
Reamer (Awl)
15 cm

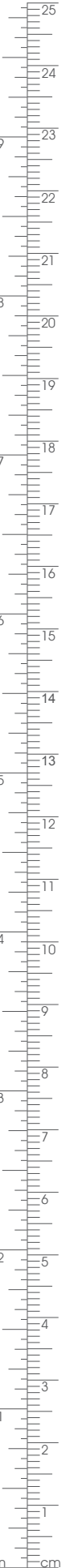

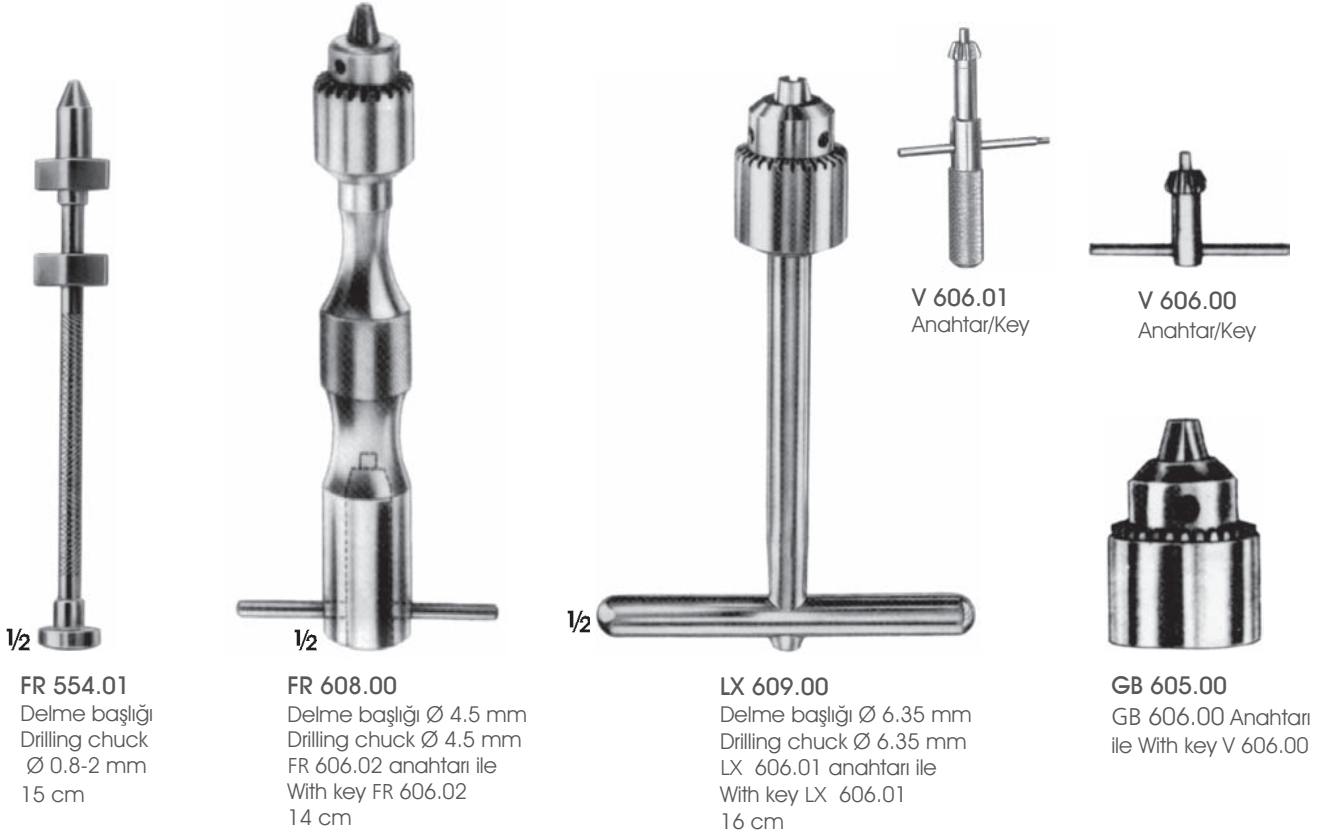

FR 554.01
Delme başlığı
Drilling chuck
Ø 0.8-2 mm
15 cm

FR 608.00
Delme başlığı Ø 4.5 mm
Drilling chuck Ø 4.5 mm
FR 606.02 anahtarı ile
With key FR 606.02
14 cm

LX 609.00
Delme başlığı Ø 6.35 mm
Drilling chuck Ø 6.35 mm
LX 606.01 anahtarı ile
With key LX 606.01
16 cm

V 606.01
Anahtar/Key

V 606.00
Anahtar/Key

GB 605.00
GB 606.00 Anahtarı
ile With key V 606.00

İç çap/Inside Ø 6.7 mm
Dış çap/Outside Ø 8.7 mm

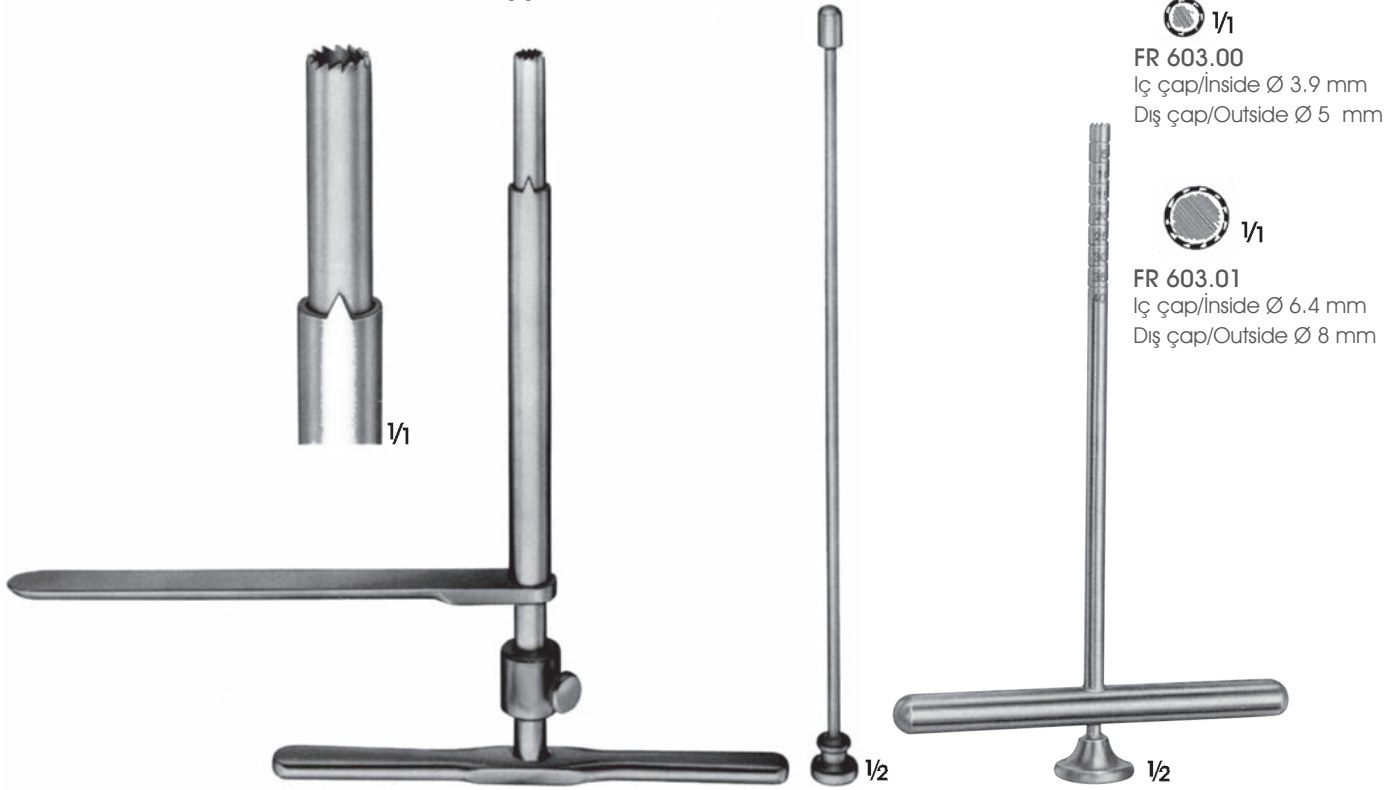

FR 603.00
İç çap/inside Ø 3.9 mm
Dış çap/Outside Ø 5 mm

FR 603.01
İç çap/inside Ø 6.4 mm
Dış çap/Outside Ø 8 mm

R.N.O.H.
FR 704.05
Kemik biyopsi trapanı
Bone biopsy trephine
19.5 cm

FR 603.00-FR 603.01
Kemik biyopsi trapanı
Bone biopsy trephine 16 cm

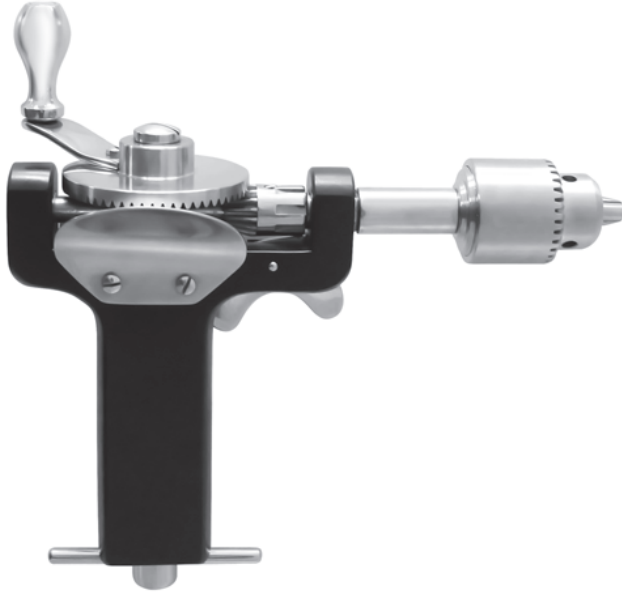

BUNNEL

FR 615.00

Küçük el matkabi, KIRSCHNER tel için delikli küçük el matkabi,
3 çene ağızlı, 4 mm çaplı başlıklar için uygundur.

Small hand drill, canullated for KIRSCHNER wires, with 3-jaw chuck,
to fit any size of shanks up to 4.0 mm diameter.

FR 606.02 anahtarı ile

With key FR 606.02

16 cm



GA 606.02
Anahtar/Key



Ayarlı sap
Adjustable handle

FR 612.00

El matkabi/Hand drill only
28 cm

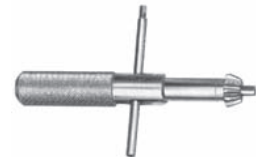

GA 606.01
Anahtar/Key

El matkabi paslanmaz, 3 çene ağızlı, 6.35 mm çaplı başlıklar için
uygundur. Orjinal 'Jacops Chuck' aynaları ile ve V 606.01 anahtarı
ile, anahtarı veya anahtarsız kullanılabilir.

Hand drill, stainless, original 'Jacops Chuck' and key V 606.01
Can be used with or without the key.





LS 623.00
20 cm

LS 623.01
25 cm



LS 622.00
20 cm

LS 622.01
25 cm



LS 621.01
20 cm

LS 621.03
25 cm



LS 621.00
20 cm

LS 621.02
25 cm



LS 620.02
20 cm

LS 620.05
25 cm

3.5 mm



LS 620.01
20 cm

LS 620.04
25 cm

2.5 mm



LS 645.01
Ø 2.7 mm
15 cm

LS 645.02
Ø 3.5 mm
17 cm

LS 645.03
Ø 4.0 mm
20 cm

LS 645.04
Ø 4.5 mm
22 cm

LS 645.01-LS 645.04
Kemik tapları/Bone taps



Ölçme sınırı
Measuring
6 - 40 mm

Vidalar için
For screws
Ø 2.7 mm
Ø 3.5 mm
Ø 4.0 mm

LS 649.00
15.5 cm



Ölçme sınırı
Measuring
10 - 60 mm

Vidalar için
For screws
Ø 4.5 mm
Ø 6.5 mm

LS 648.00
22 cm



LS 616.00
Plak tutucu pens
Plate holding forceps
20 cm



Elmas Kesici Ağız
With Carbide Cutting Edges



1/2

REILL
LX 640.00
Kemiğe yakın olan telleri kesme
For cutting off wires close to the bone
17.5 cm



1/1

Yumuşak tel için Ø 2.0 mm
For soft wire Ø 2.0 mm
Sert tel için Ø 1.5 mm
For hard wire Ø 1.5 mm



1/1

Düz ağız
Smooth jaw

1/2

GOSLEE
DP 617.00
Tel bükücü, düz burunlu
Wire twister, flat nosed
14 cm



1/1

Tırtıllı ağız
Serrated jaw



HF 683.00
15 cm



KH 750.00
1.5 mm



KH 752.00
20 cm



KH 754.04
KH 754.05-KH 754.06
ile kullanılır.
To be use with
KH 754.05 and KH
754.06



KH 754.00
Kılavuz/Guide
23 cm



KH 754.05
Ø 2.5 mm



KH 754.06
Pin/Pin





LS 622.00
Bükme kolu
Bending iron
14 cm



LS 622.01
Bükme kolu
Bending iron
14 cm



LS 621.00
Bükme kolu
Bending iron
16 cm



JEWETT
LS 623.00
Bükme kolu
Bending iron
20 cm



JEWETT
LS 623.01
Bükme kolu
Bending iron
20 cm

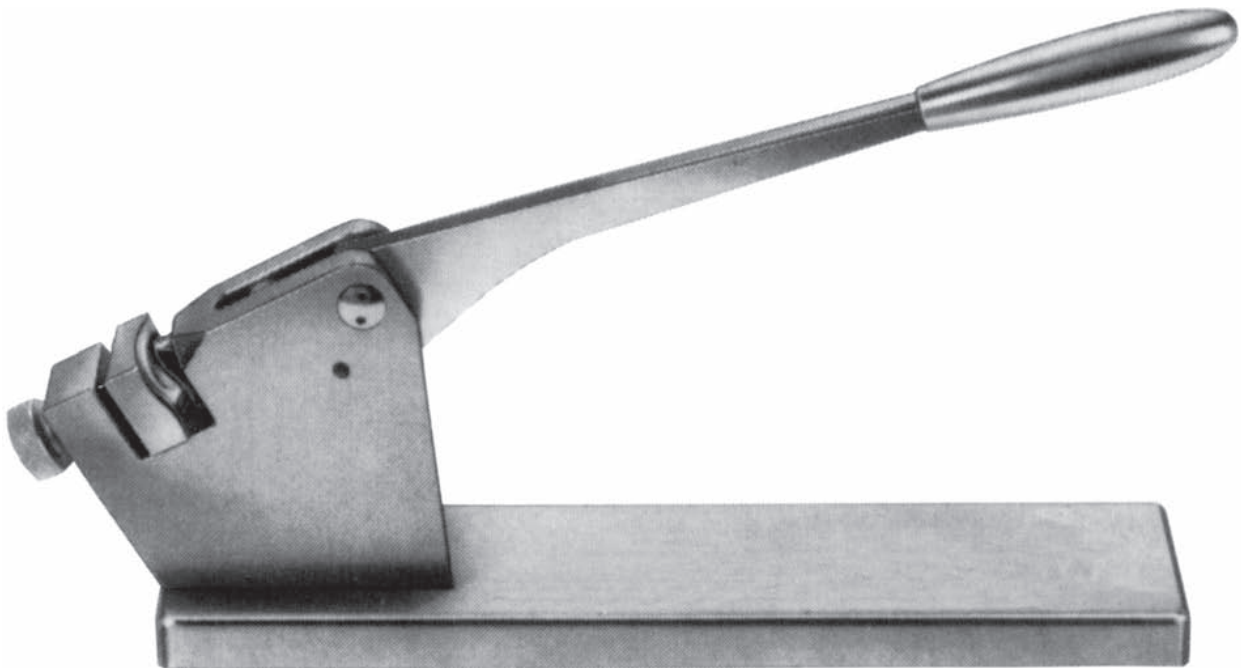

LS 625.00
Bükme ve kıvrma aparatı
Plate bending and contouring device



LS 712.00
10 cm



LS 713.00
10 cm



LS 710.00 Ø 2.5 mm
LS 710.01 Ø 3.5 mm
14 cm



LS 711.00 Ø 3.5 mm
18 cm



LX 675.00
20 cm



FL 711.03P 9 mm
Kırık vida çıkartıcı guj
Broken screw extractor guj
22 cm

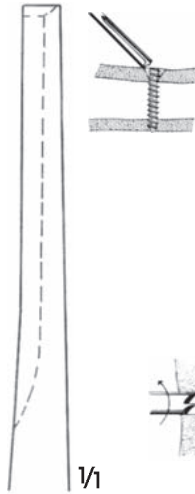

1/1

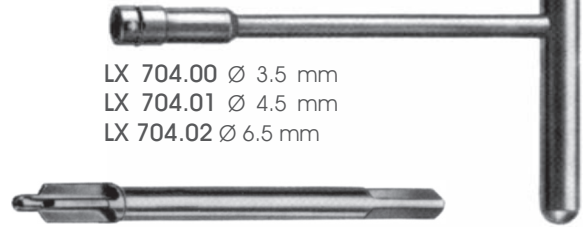
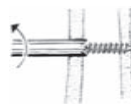
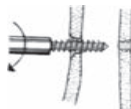
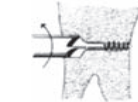

LX 704.00 Ø 3.5 mm
LX 704.01 Ø 4.5 mm
LX 704.02 Ø 6.5 mm



LS 707.00 Ø 3.5 mm
LS 707.01 Ø 4.5 mm
LS 707.02 Ø 6.5 mm



LS 706.00 Ø 3.5 mm
LS 706.01 Ø 4.5 mm
LS 706.02 Ø 6.5 mm



LS 705.00 Ø 3.5 mm
LS 705.01 Ø 4.5 mm
LS 705.02 Ø 6.5 mm

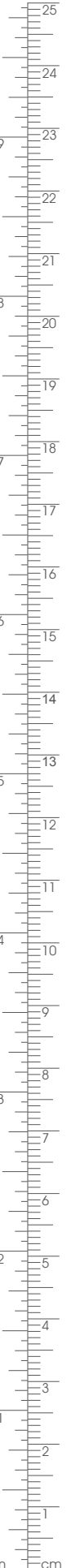

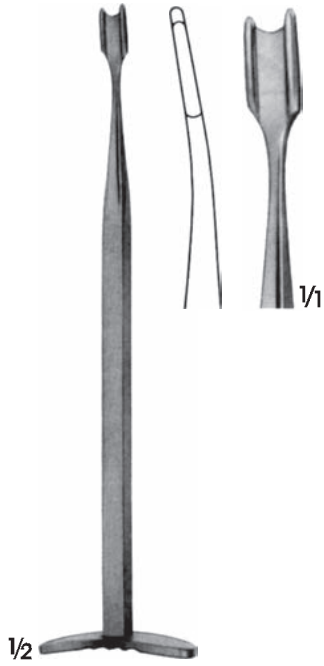

SMILLIE
 FO 515.00
 Menisküs bıçak
 Meniscus knife
 17 cm

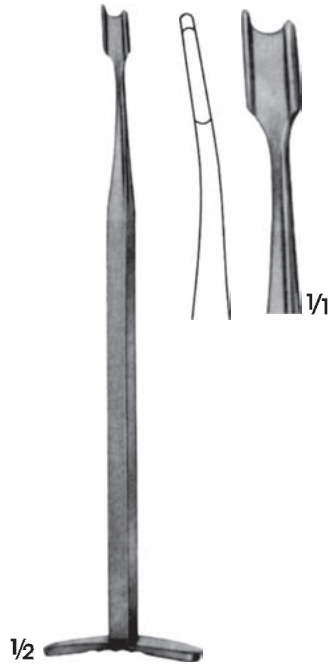

SMILLIE
 FO 516.00
 Menisküs bıçak
 Meniscus knife
 17 cm

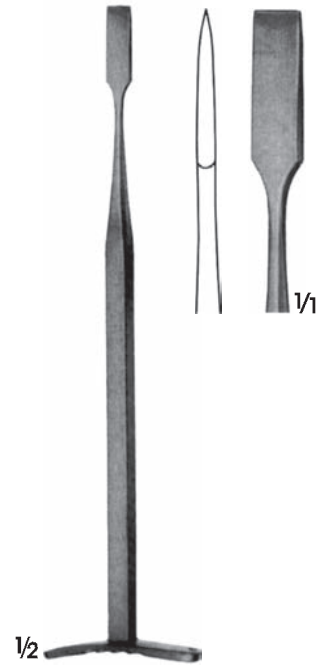

SMILLIE
 FO 517.00
 Menisküs bıçak
 Meniscus knife
 17 cm

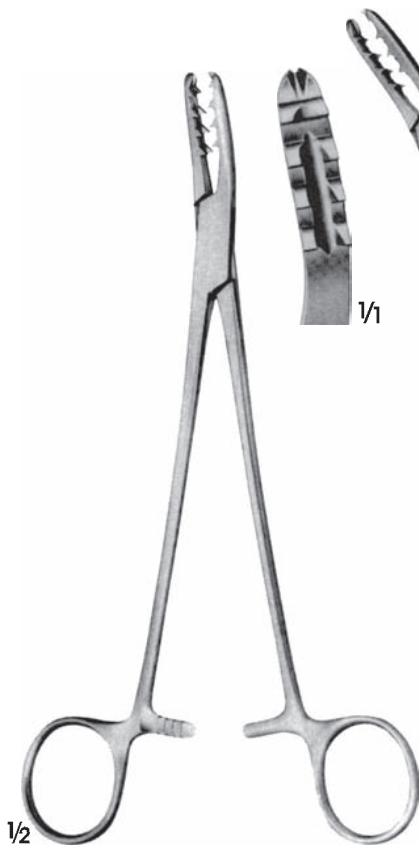

BIRCHER-GANSKE
 FO 660.00-FO 661.00
 Menisküs pensi
 Meniscus forcep
 20 cm

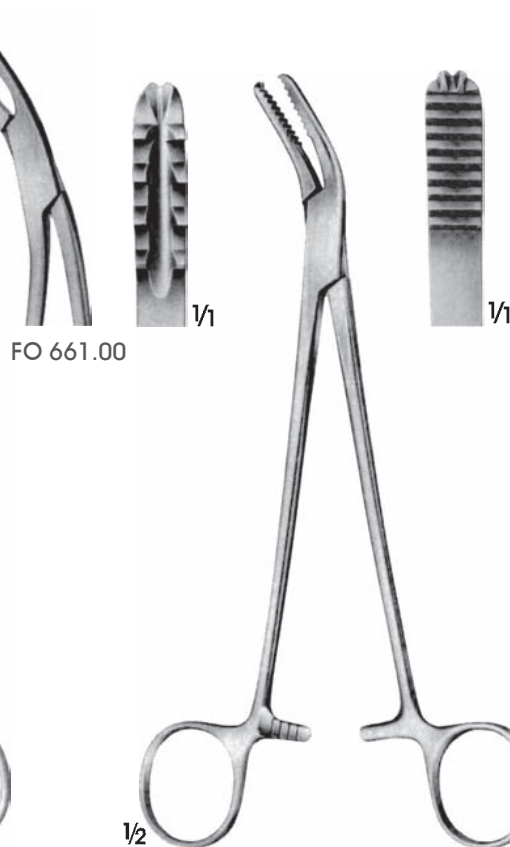

WELLER
 FO 662.00
 Menisküs pensi
 Meniscus forcep
 20 cm



FO 664.00
 Menisküs pensi
 Meniscus forcep
 20.5 cm

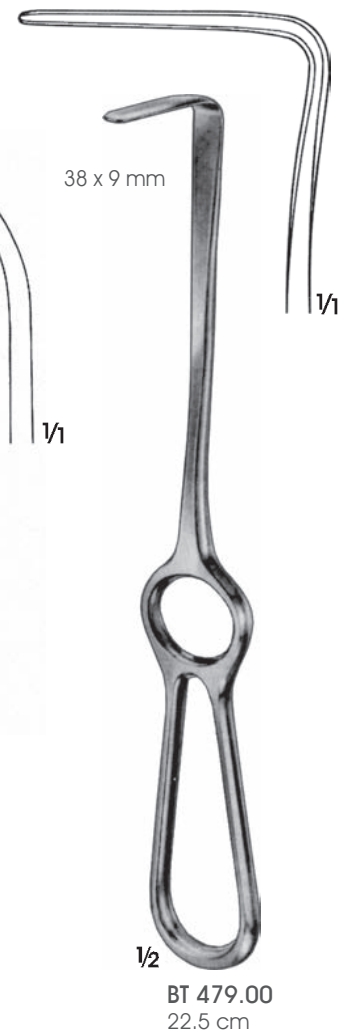
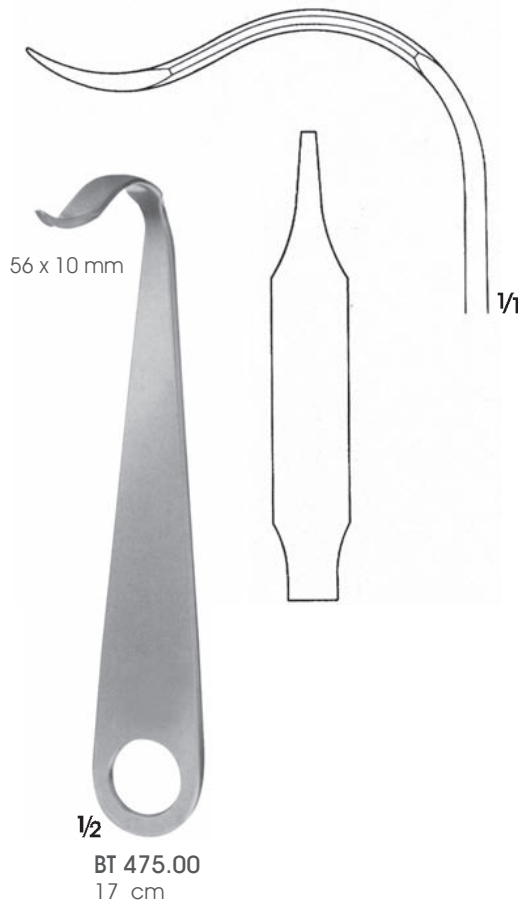
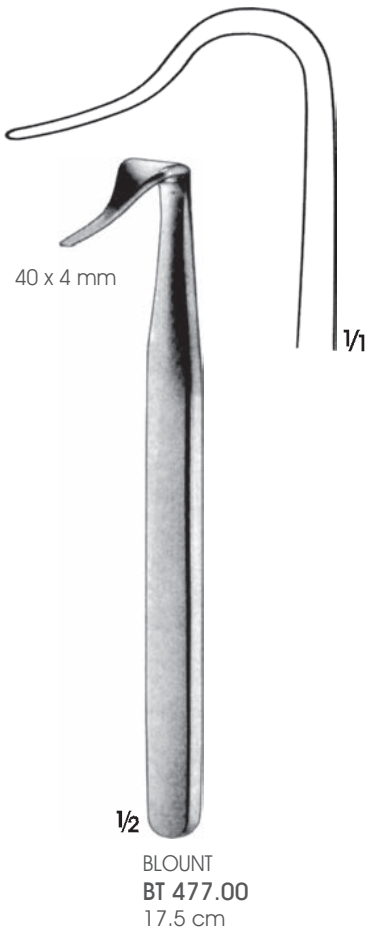
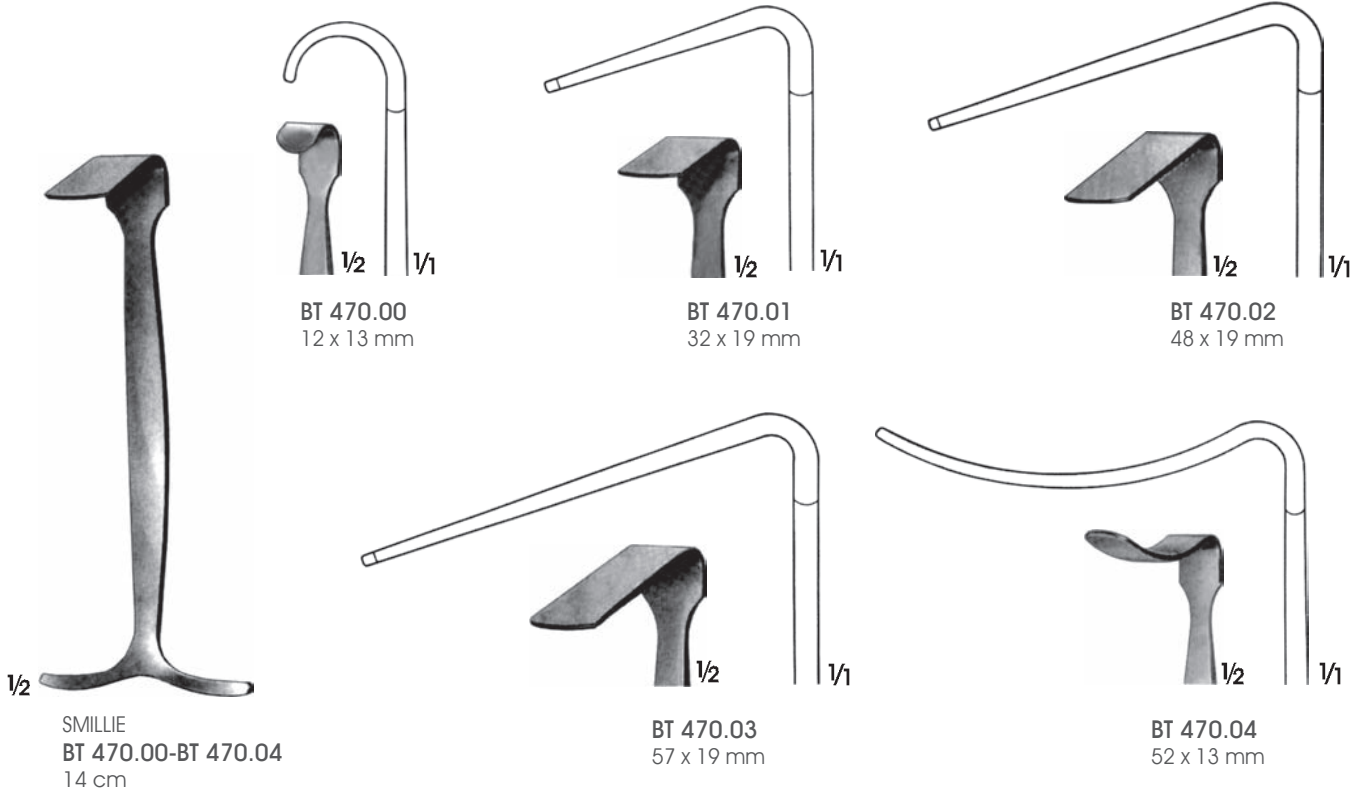



KUNTSCHER
KH 725.06 Ø 6 mm
KH 725.07 Ø 7 mm
KH 725.08 Ø 8 mm
KH 725.09 Ø 9 mm
KH 725.10 Ø 10 mm
KH 725.11 Ø 11 mm
KH 725.12 Ø 12 mm
KH 725.13 Ø 13 mm
KH 725.14 Ø 14 mm
KH 725.15 Ø 15 mm
KH 725.16 Ø 16 mm
Sabit oyucu
Fixed reamer
50 cm



KUNTSCHER
GC 727.06 Ø 6 mm
GC 727.07 Ø 7 mm
GC 727.08 Ø 8 mm
GC 727.09 Ø 9 mm
GC 727.10 Ø 10 mm
GC 727.11 Ø 11 mm
GC 727.12 Ø 12 mm
GC 727.13 Ø 13 mm
GC 727.14 Ø 14 mm
GC 727.15 Ø 15 mm
GC 727.16 Ø 16 mm
Bükülebilir oyucu
Malleable reamer 48
cm



ND 729.00
KUNTSCHER "T" kolu,
bükülebilir oyucular için
"T" Wrench, for malleable
reamers

ND 711.00
Çıkartıcı/Extractor
25 cm



ND 712.00
Çıkartıcı/Extractor
27 cm



ND 701.00
İtici/Pusher
25 cm



ND 714.00
MORE protez çıkartıcı
MORE protheses extractor
50 cm



BV 895.00
Kalça ekartörü
Hip retractor



ND 795.00
Zincirli ağırlık
Weight with chain
1 kg

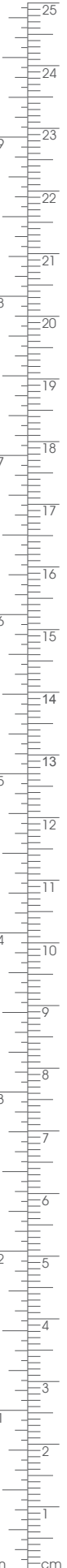



ND 720.00
Çement itici
Cement pusher
30 cm



ND 721.00
Çement itici
Cement pusher
30 cm



ND 745.00-ND 747.02
Osteotom ve guj Chisel
and gouge 35 cm



ND 745.00
5 mm



ND 746.00
5 mm



ND 747.00
5 mm



ND 745.01
7 mm



ND 746.01
7 mm



ND 747.01
7 mm



ND 745.02
10 mm



ND 746.02
10 mm



ND 747.02
7 mm



Osteotom/Çizil
Osteotome/Chisel



Guj/Gouge



Guj/Gouge



OP 780.00
40 cm

FO 735.00
Ø 6 mm
40 cm

FO 736.00
Ø 8 mm
40 cm

FO 737.00
Ø 10 mm
40 cm

ND 725.00
Çekiç / Mallet
22 cm

ND 726.00 Ø 7 mm
ND 726.01 Ø 9 mm
ND 726.02 Ø 11 mm
Çement çıkartıcı
Cement extractor 60
cm

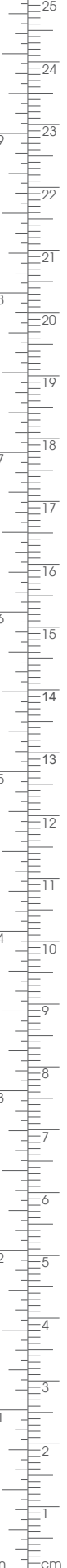

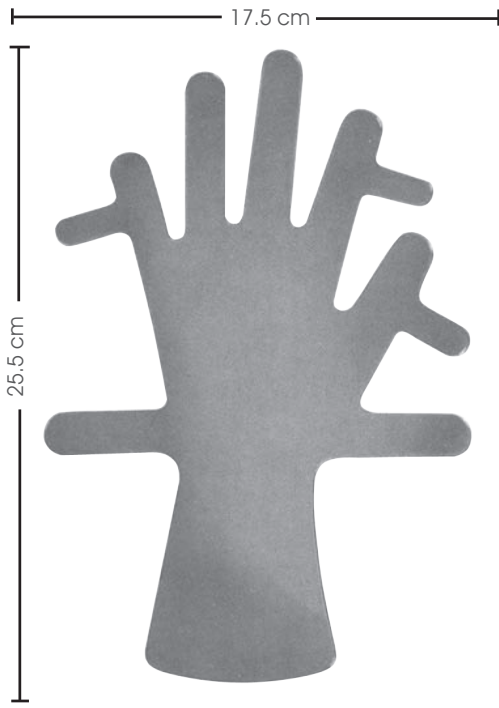

ND 750.00

Çocuklar için el sabitleyici, yumuşak
Children's hand control, soft

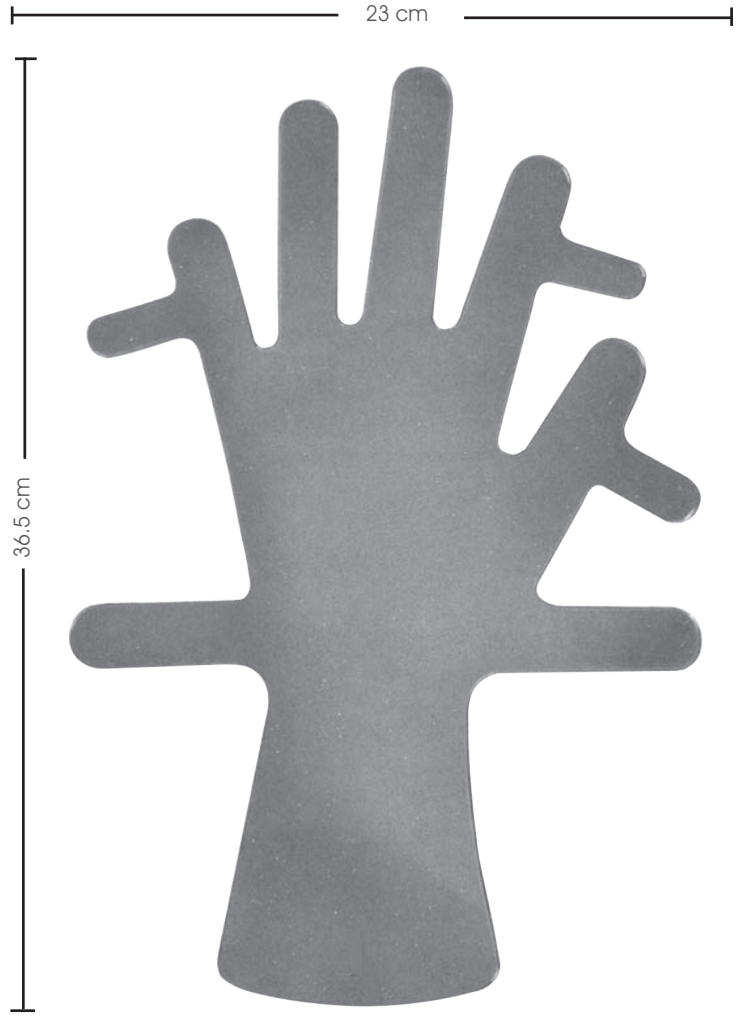

ND 750.01

Yetişkinler için el sabitleyici, yumuşak
Used stabilizer for adults, soft

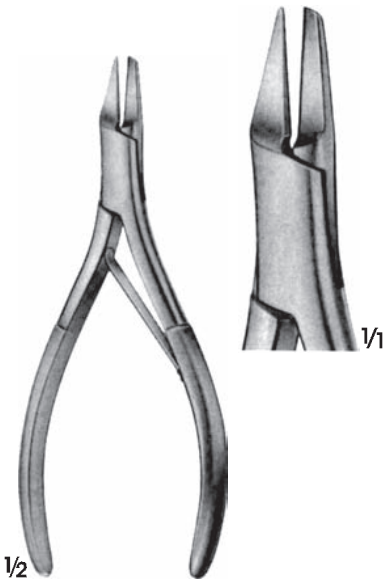

HF 685.00

Tırnak çıkarma penci
Nail splitting forceps
13 cm



FO 686.00

Tırnak çıkarma penci
Nail extracting forceps
13.5 cm



FO 670.00

Parmak yüzük testere
Finger ring saw
15 cm

FO 670.01
Yedek bleyd
Spare blade



1/2

JOSEPH
OL 765.00
El testere
Hand saw
17 cm



1/2

LINDEMANN
DO 766.00
El testere
Hand saw
20 cm



1/2

SYSTRUNK
BC 660.00
Parmak tırnak kesme makası
Scissors for splitting finger nails
13 cm

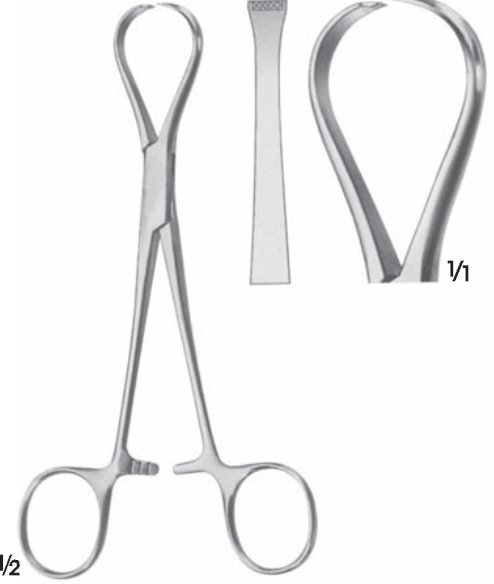

1/2

JACKSON
BF 300.00
Tendon tutucu pens
Tendon seizing forceps
4 x 5 diş/4 x 5 teeth
15 cm



1/2

HERZ
BF 302.00
Tendon tutucu pens
Tendon seizing forceps
15.5 cm

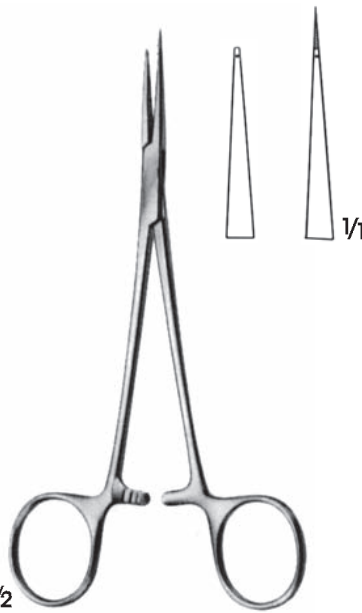

1/2

FO 311.00
Tendon geçmeli pens
Tendon interlacing forceps
15 cm

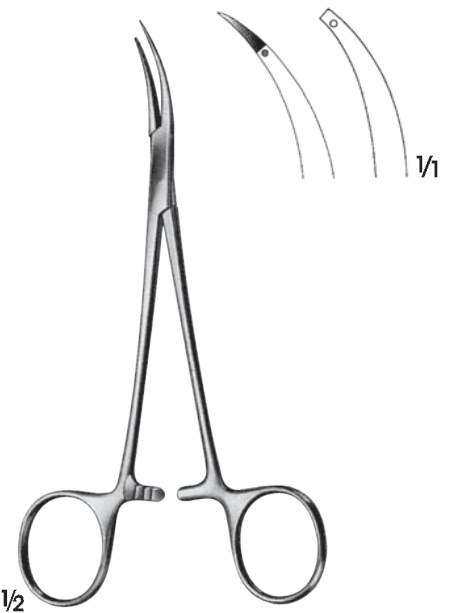

1/2

FO 312.00
Tendon geçmeli pens
Tendon interlacing forceps
15 cm



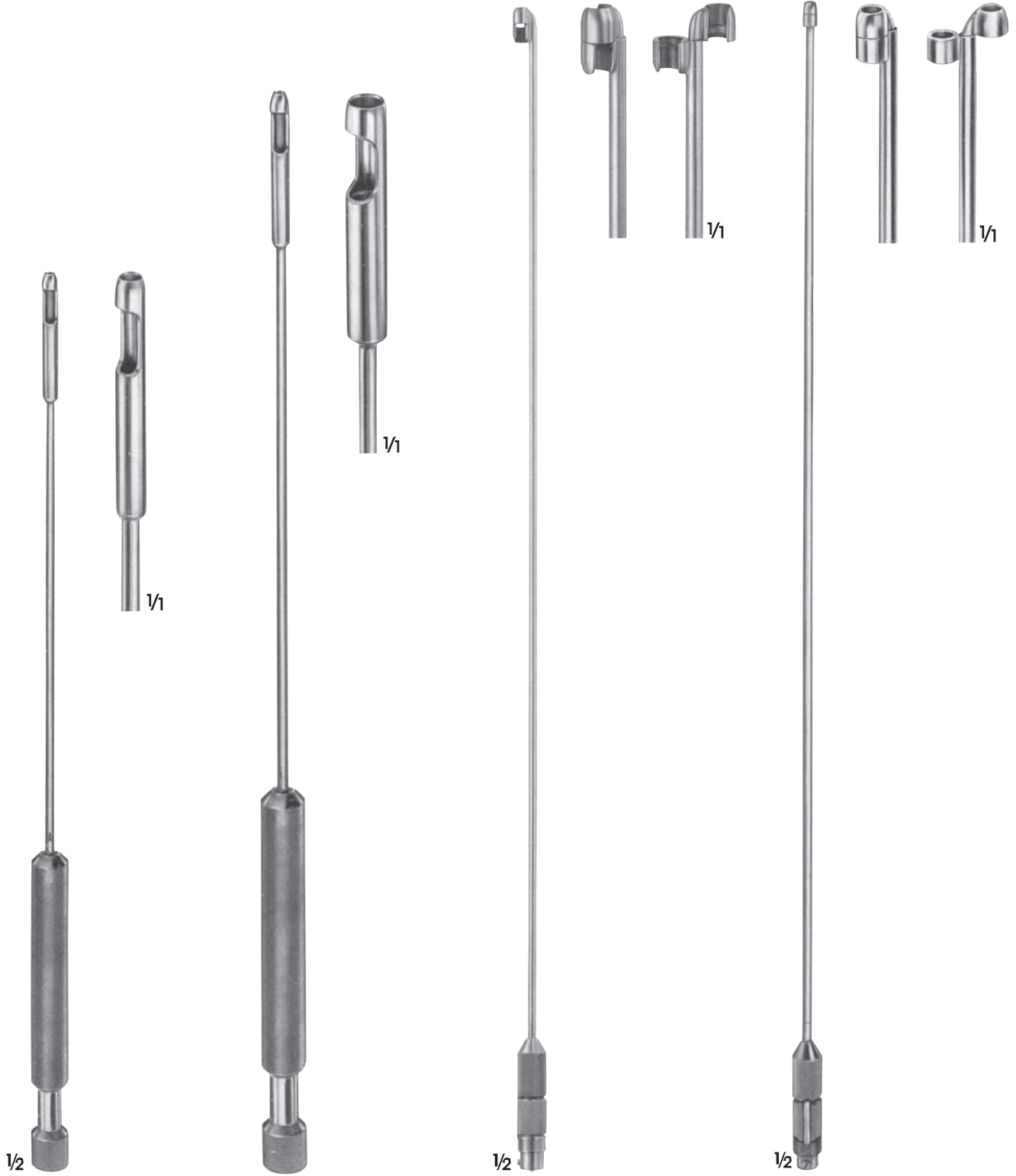

FF 089.01 Ø 3 mm Tendon stripper
Tendon stripper
Şaft uzunluğu
Schafflänge 19 cm
Toplam boy
Shaft length 30 cm

FF 089.03 Ø 5 mm Tendon stripper
Tendon stripper
Şaft uzunluğu
Schafflänge 39 cm
Toplam boy
Shaft length 49.5 cm

REILL
FF 088.00 Ø 4 mm
FF 088.01 Ø 6 mm
Tendon stripper
Tendon stripper
Şaft uzunluğu
Schafflänge 35 cm
Toplam boy
Shaft length 39.5 cm

ASSMUS
FF 086.00 Ø 3 mm
Sinir stripper, Künt
Nerve stripper, blunt
Şaft uzunluğu
Schafflänge 35 cm
Toplam boy
Shaft length 39.5 cm

BN 035.00 Ø 2.5 mm
BN 035.01 Ø 2.5 mm
BN 035.02 Ø 3.0 mm



1/2



BUNNELL
BN 034.00
23 cm



1/2

BUNNELL
ND 760.00 Ø 2 mm
ND 760.01 Ø 3 mm
ND 760.02 Ø 4 mm
ND 760.03 Ø 6 mm
13.5 cm

C
ND 760.00

C
ND 760.01

C
ND 760.02

C 1/1
ND 760.03

1/2



FO 763.00 Ø 3 mm
FO 763.02 Ø 5 mm
30 cm

1/1
FO 763.00

1/1
FO 763.02



FO 764.03 Ø 5 mm
50 cm



FH Anatomi, Amputasyon ve Otopsi Aletleri
Instruments For Anatomy, Amputation and Post Mortem



 **ARGENT**

Çift taraflı kesici
Double cutting

Çift taraflı kesici
Double cutting



AA 160.00 AA 161.00

1/2

1/2

1/2

1/2

1/2

LANGENBECK
AA 160.00-AA 161.00
Rezeksiyon bıçakları
Resection knives Ağız
uzunlukları Length of
blade 5.5 cm

AA 163.00
Periyost bıçak
Periosteum knife
Ağız uzunluğu
Length of blade
6.5 cm

FH 141.00
Interosseöz bıçak
Interosseous knife
Ağız uzunluğu
Length of blade
11 cm

FH 144.00
Falanks bıçak
Phalangeal knife
Ağız uzunluğu
Length of blade
10.5 cm

LANGENBECK
FH 143.00
Kanat bıçak
Flap knife
Ağız uzunluğu
Length of blade
12 cm

LISTON
FH 146.00 13 cm
FH 146.01 16 cm
FH 146.02 19 cm
FH 146.03 22 cm
Amputasyon bıçak
Amputation knives

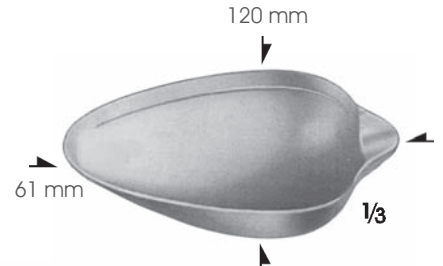

FB 886.00
Kan kaşığı/Blood scoop
Hacmi 50 cc/Volume 50 cc

Çift taraflı kesici
Double cutting



1/2

CATLIN
FH 145.00
Ampütasyon bıçak
Amputation knife
Ağız uzunluğu
Length of blade
16 cm



1/2

AA 108.00
Ağız uzunluğu
Length of blade
13 cm



1/2

AA 165.00
Ağaç sap/Wooden handle
Ağız uzunluğu/Length of blade
17 cm



1/2

AA 156.00
Ağız uzunluğu
Length of blade
19.5 cm



Ø 90 mm

BT 885.00
Kan kaşığı
Blood scoops
Hacmi/Volume 50 cc





GIGLI
FH 536.00 30 cm
FH 536.01 40 cm
FH 536.02 50 cm
İki sargılı/Two windings



GIGLI
FH 537.00 30 cm
FH 537.01 40 cm
FH 537.02 50 cm
Üç sargılı/Three winding

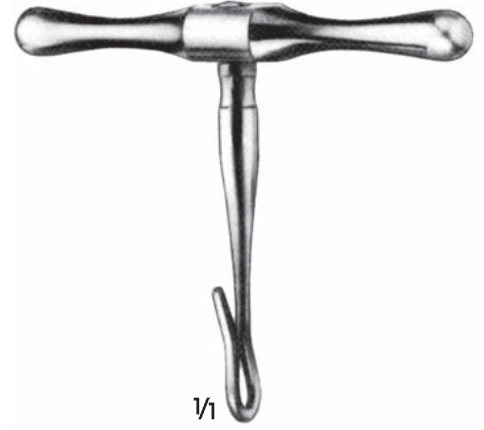

GIGLI
FH 530.00
Sap/Handle



DE MARTEL
FF 540.00 35 cm
Kondüktör için gigli testere teli, esnek
Gigli saw for the flexible conductor wire

LEBSCHE
OG 255.01
Tel testeresi için klavuz
Conductor for wire saws
Bükülebilir/Malleable
25 cm



LANGENBECK
FH 600.00
Metakarpal testeresi
Metacarpal saw
Ağız uzunluğu
Length of blade
11.5 cm
23.5 cm



FH 602.05
Bleyd uzunluğu
Length of blade
20 cm

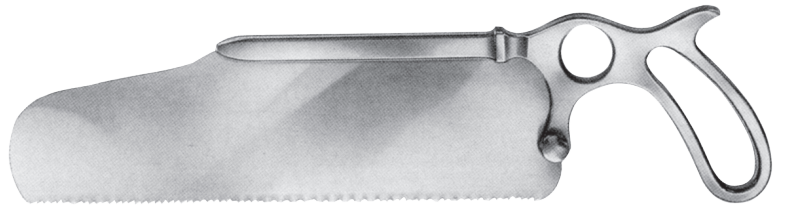

SATTERLEE
FH 602.00
29 cm

FH 603.05 18 cm
FH 603.06 24 cm
Ağız uzunluğu
Length of blade

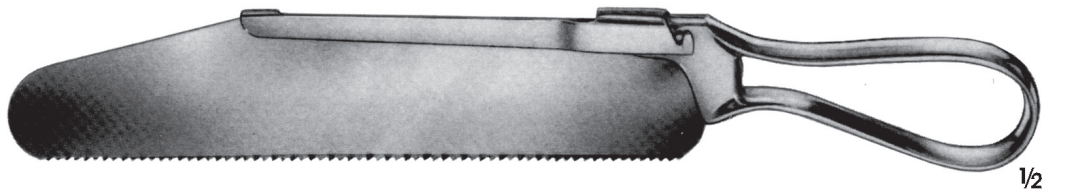

CHARRIERE
FH 603.00 27 cm
FH 603.02 34 cm

FH 608.10 Komple/Complete
FH 608.00, FH 608.05, FH
608.07

CHARRIERE

FH 608.00

Sadece sap/Only handle 35
cm

FH 608.05 12 mm

FH 608.07 18 mm

Bleyd uzunluğu
Length of blade
21.5 cm

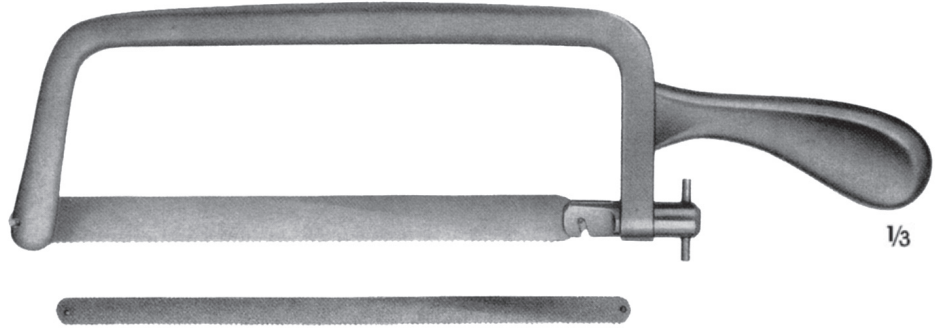

FH 609.12 Komple/Complete

FH 609.00 ,FH 609.05, FH

609.06 (1 adet/1 each)

FH 609.07 (2 adet/2 each)

RUST

FH 609.00

Sadece sap/Only handle 39
cm

FH 609.05 6 mm

FH 609.06 8 mm

FH 609.07 12 mm

FH 609.08 18 mm

Bleyd uzunluğu
Length blade
23.5 cm

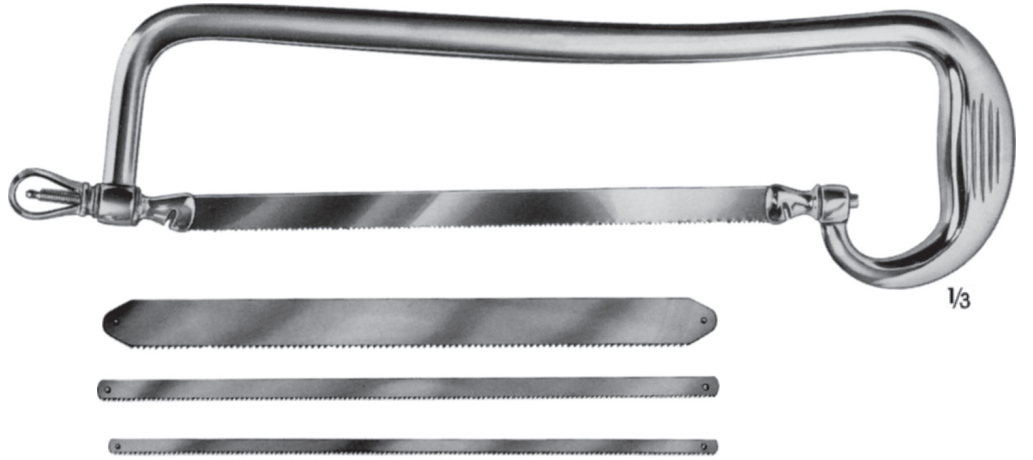

BIER

FH 607.10 Komple/Complete

FH 607.00, FH 607.03. FH

607.04 FH 607.06

FH 607.00

Sadece sap/only handle 42
cm

FH 607.03 4 mm

FH 607.04 6 mm

FH 607.06 8 mm

Bleyd uzunluğu
Length blade
27 cm



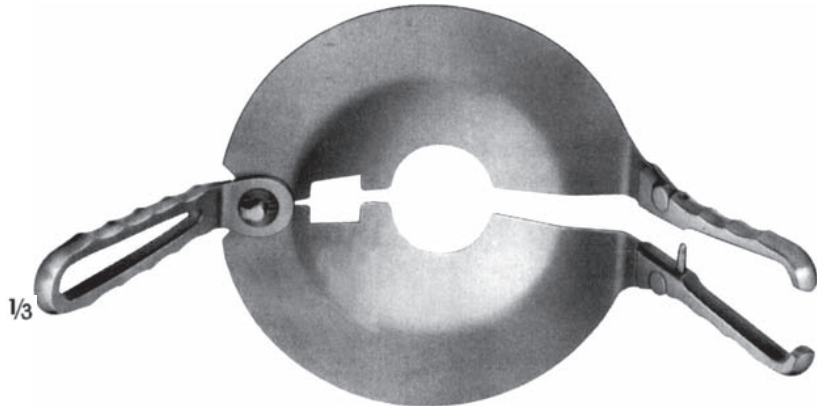

PERCY
FH 890.00
Sökülebilir saplı
Removable handles

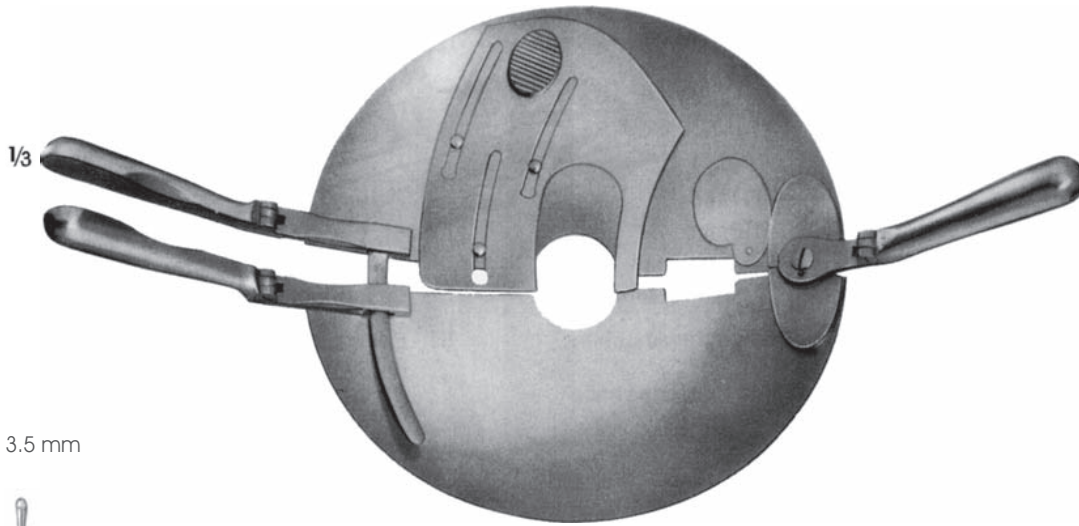

PERCY
FH 891.00
Ters çevrilebilir saplı
Reversible handles

Ø 3.5 mm



BN 038.01 30 cm Çift
başlı sonda bükülebilir,
delikli Double ended
probes, malleable,
with hole



BD 240.03-BD 240.05
Standart model/Standard pattern
Diseksiyon penseti/Dissecting forceps

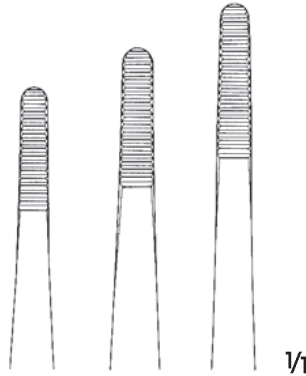

BD 240.03 16 cm
BD 240.04 18 cm
BD 240.05 20 cm

1/1



STANDARD
BD 360.04-BD 360.06
Standart model
Standard pattern

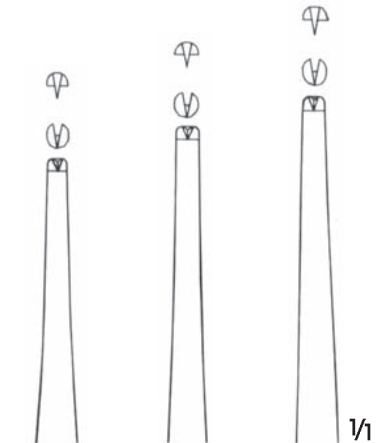

BD 360.04 16 cm
BD 360.05 18 cm
BD 360.06 20 cm

1/1



1/2

AA 616.00
21 cm



1/2

AA 617.00
21 cm



AA 690.00 19.5 cm
AA 690.01 22.5 cm



1/2

FB 513.01 23 cm



1/2

SEMB
FO 135.00
19 cm



1/2

FERGUSON
FO 152.00
20.5 cm



STILLE

- FL 651.04 8 mm
- FL 651.05 10 mm
- FL 651.06 12 mm
- FL 651.07 15 mm
- FL 651.08 20 mm
- FL 651.09 25 mm

1/2



BERGMANN
FL 818.02 245 gr.
23.5 cm

1/2

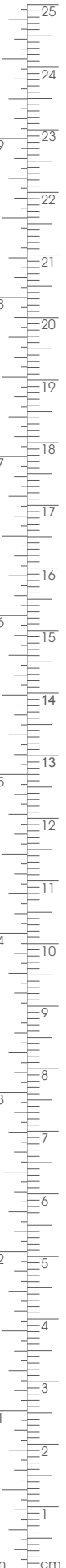

DE Dermatoloji
Dermatology



 **ARGENT**



- OL 200.01 Ø 2 mm
- OL 200.02 Ø 3 mm
- OL 200.03 Ø 4 mm
- OL 200.04 Ø 6 mm
- OL 200.06 Ø 7 mm

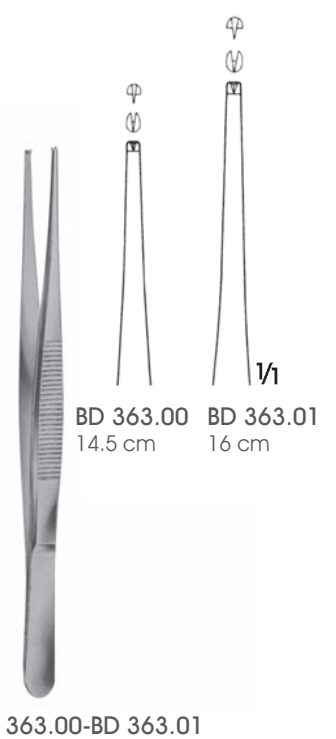
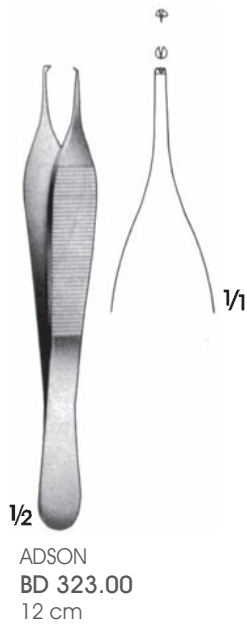
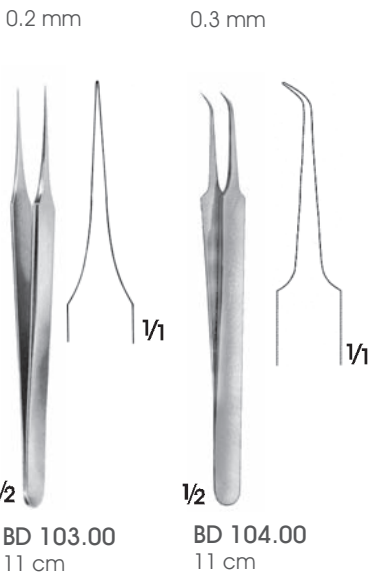

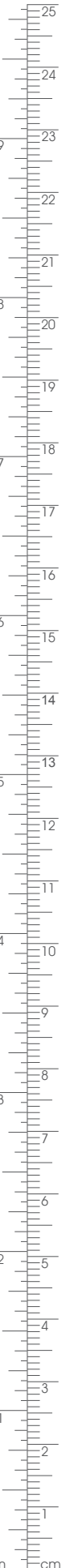
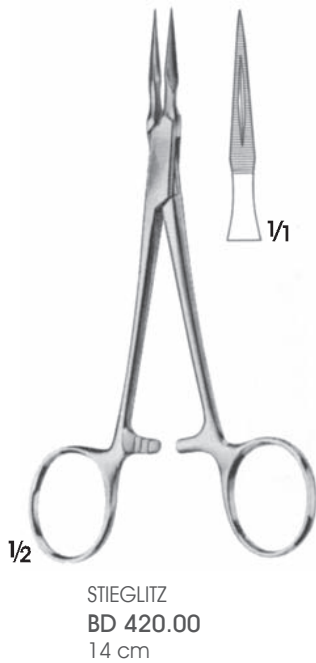
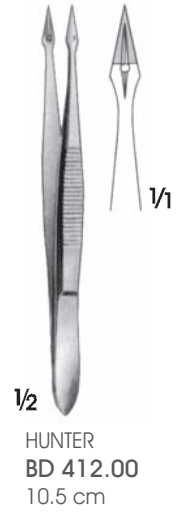

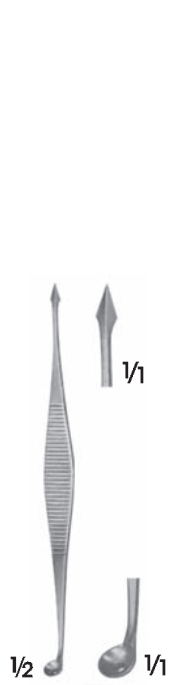

SAALFELD
HH 215.00
10 cm

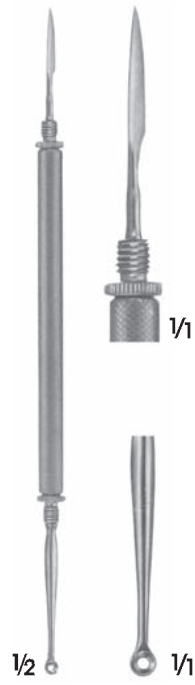

HEBRA
HH 217.00
18 cm



HH 218.00
14.5 cm



UNNA
OL 160.00
14 cm



VIDAL
M 163.00
13.5 cm



KILNER
OL 127.00
16 cm

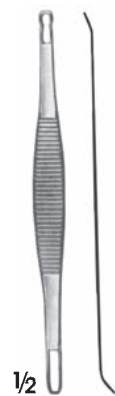

SCHAMBERG
HH 161.00
10 cm

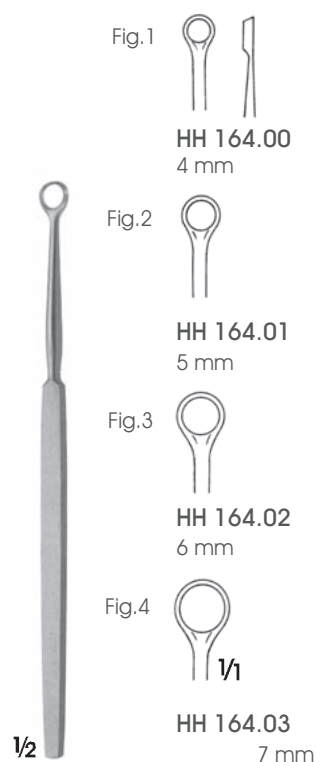

FOX
HH 164.00-HH 164.03
14 cm

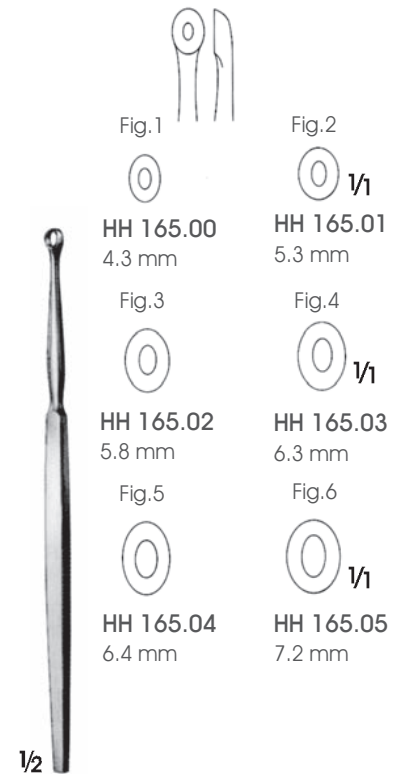

WOLFF
HH 165.00-HH 165.05
14 cm



1/2

SILVER
BA 186.00P
Cilt nakil bıçağı, bıçaksız
Skin graft knife, without blade
19 cm

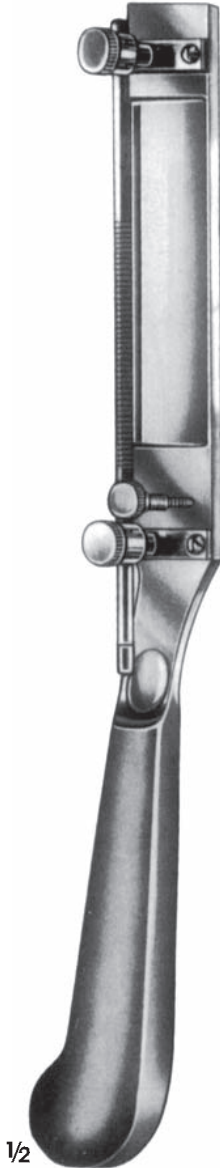

1/2

SCHINK
BA 182.00
Sadece dermatom
Dermatom only
30 cm

BA 188.01
Yedek Bıçak
Spare blade only

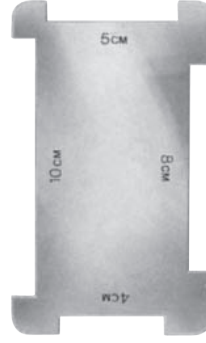

BA 188.00
Cilt doğrultma plağı
Skin straightening plate
only



1/2

WATSON
BA 184.00
Cilt nakil bıçağı, bıçaksız
Skin graft knife, without blade
30 cm

Sabit bar
Bar fixed



FD Mikroskopi
Microscopy



 **ARGENT**



BD 250.00
10 cm

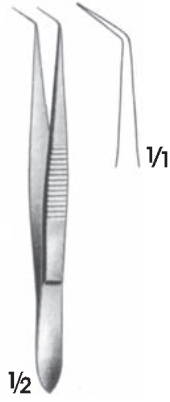

BD 251.00
10 cm



BD 252.00
10 cm

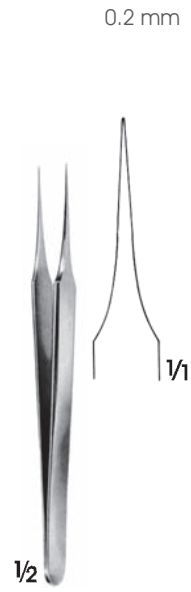

BD 103.00
11 cm

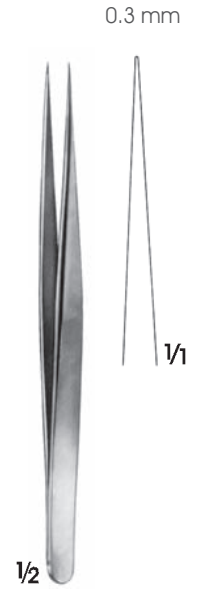

BD 108.00
13.5 cm



VANNAS
BD 070.00
Düz/Straight
Hassas/Delicate
8.5 cm



FD 102.00-FD 103.00
Mikro makaslar Micro
scissors
12 cm



FD 103.00
Eğri/Curved



REILL
FD 126.00-FD 127.00
Kilitsiz/Without catch
15 cm



OF 228.00

Metal saplı,
mikroskopik iğne
Microscopic needle, with
metal handle
13 cm

OF 229.00

Metal saplı,
mikroskopik iğne
Microscopic needle with
metal handle
13 cm

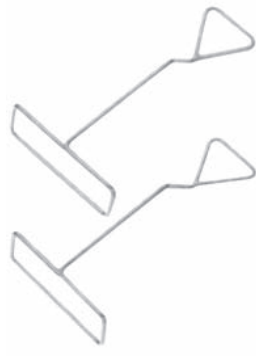

MULLER

BV 004.00

Fare için ekartör bir çift
Retractors for mouse
pairs



1/2

FINSEN

BV 082.00

7.5 cm

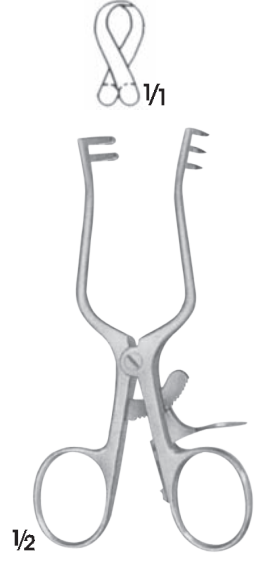

1/2

WEITLANER
LBV11 cm



1/1

FD 030.00

Approximatör/Approximator

Derin aralıkta mikro damar anastomileri için.
Güvenli ve dikkatli şekilde damar kavrama.
Tırtıklı yüzeyli bleydler.
El ile basınç ayarı yapabilme özelliği.
Mesafeyi el ile yakınlaştırma ve uzaklaştırma.

For micro vessel anastomosis
Safe and careful gripping of vessel.
Blades with serrated blade surface
The ability to manually set the pressure
Distance, zoom in and out manually



1/1

BIEMER

FD 026.00

Komple Aproksimatör,
anahtar ile S 029.00
Approximator, complete
with key S 029.00

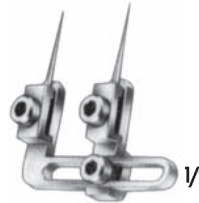

1/1

BIEMER

FD 025.00

Komple Aproksimatör,
anahtar ile S 029.00
Approximator, complete
with key S 029.00

1/1

FD 029.00

Anahtar/Key

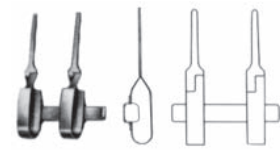

1/2

BIEMER

FD 035.00

Kilitsiz/Without Lock
BIEMER damar klip ve BIEMER-MÜLLER
ve MÜLLER yaklaşıtrıcılar için başvuru pensi
Applying forcep for BIEMER vessel clip and
BIEMER-MÜLLER and MÜLLER approximators
14 cm



GK Elektrocerrahi Aletleri
Electrosurgical Instruments



 **ARGENT**

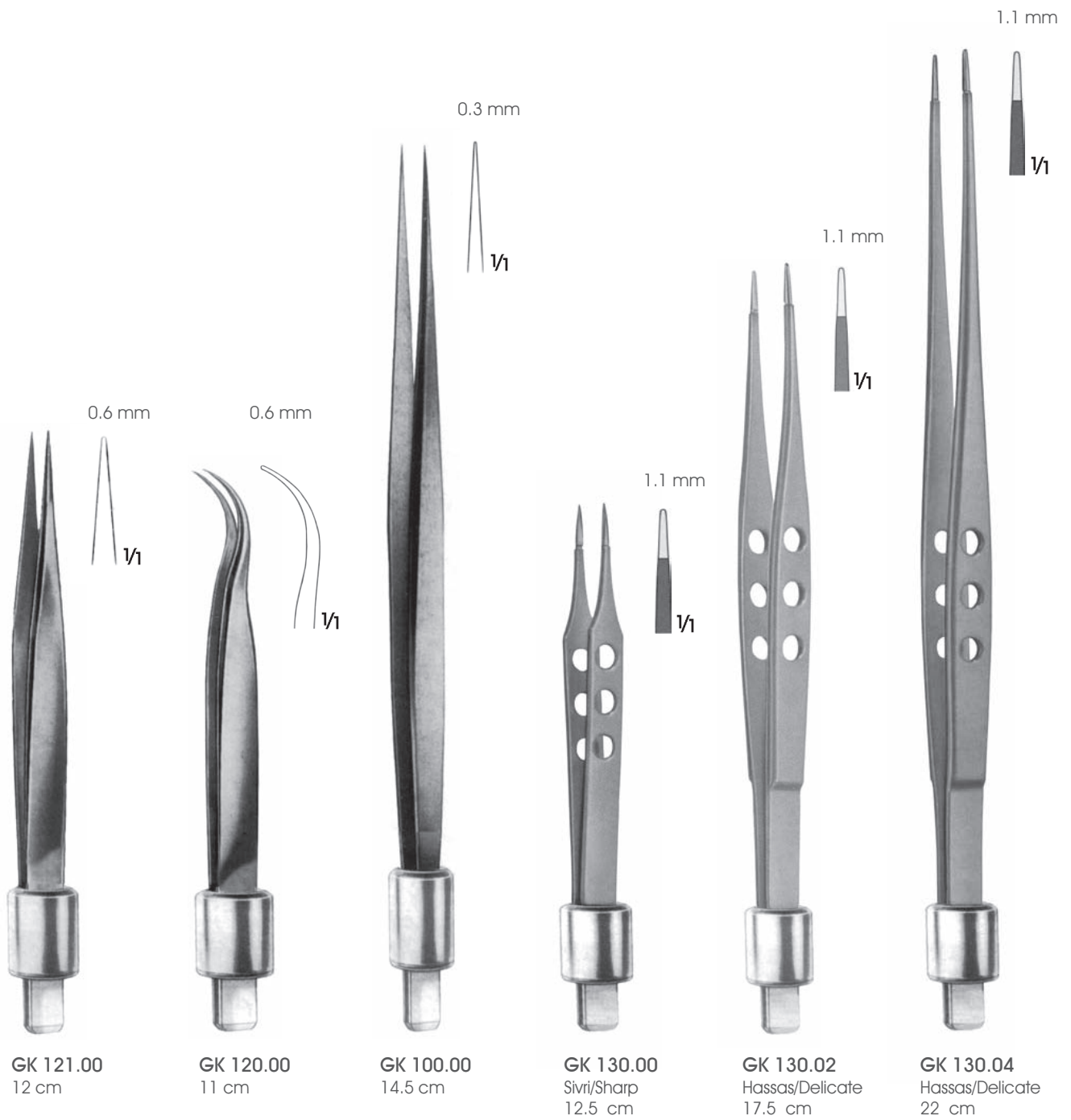

Yapışmaz/Non sticking

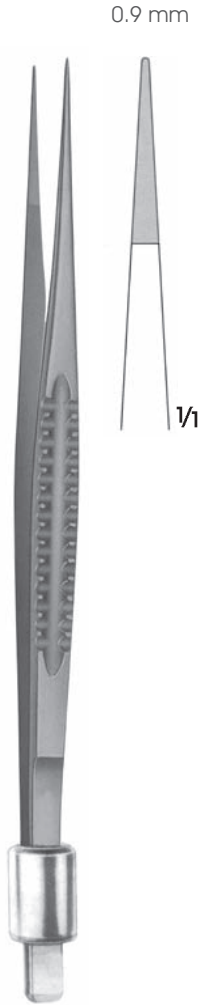

GK 170.01
Düz/Straight
İzolesiz/Non-insulated
16 cm



GK 170.04
Düz/Straight
İzolesiz/Non-insulated
18.5 cm



GK 170.07
Düz/Straight
İzolesiz/Non-insulated
20 cm

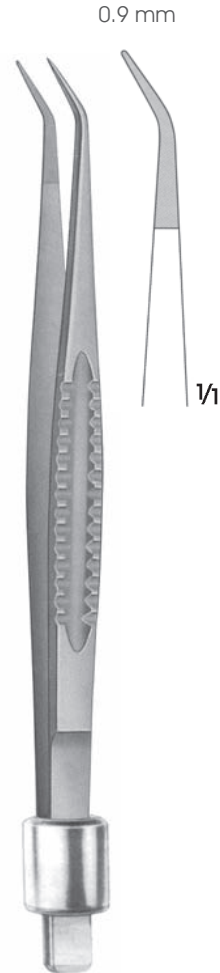

GK 171.01
Açılı/Angled
İzolesiz/Non-insulated
16 cm



GK 172.01
Açılı/Angled
İzolesiz/Non-insulated
20 cm



Izoleli
Insulated

Izoleli
Insulated

Izoleli
Insulated



Özellikler

- Doku hazırlanması ve ayırması için uygun.
- Yuvarlak çalışma uçları.
- Dayanıklı izolasyon kaplaması.
- Güvenilir fişli bağlantı.

Features

- Suitable for tissue preparation and spreading.
- Rounded working tips.
- Durable insulation coating.
- Reliable plug-in connection.

GK 150.00 0.6 mm
GK 150.01 0.9 mm
16 cm
GK 150.03 0.9 mm
20 cm

GK151.03 0,9
mm 20 cm
GK 151.01 0.9
mm 16 cm

GK 160.00 0.4 mm
GK 160.01 0.7 mm
GK 160.02 1.0 mm
GK 160.03 1.3 mm
14 cm
GK 160.04 0.4 mm
GK 160.05 0.7 mm
GK 160.06 1.0 mm
GK 160.07 1.3 mm
15.5 cm

GK 160.08 0.4 mm
GK 160.09 0.7 mm
GK 160.10 1.0 mm
GK 160.11 1.3 mm
17.5 cm
GK 160.12 0.4 mm
GK 160.13 0.7 mm
GK 160.14 1.0 mm
GK 160.15 1.3 mm
19.5 cm

GK 160.16 0.4 mm
GK 160.17 0.7 mm
GK 160.18 1.0 mm
GK 160.19 1.3 mm
21.5 cm
GK 160.20 0.4 mm
GK 160.21 0.7 mm
GK 160.22 1.0 mm
GK 160.23 1.3 mm
23.5 cm

GK 160.26 0.7 mm
25.5 cm

Izoleli
Insulated



0.2 mm 0.5 mm 1.0 mm 2.0 mm

Özellikler

- İnce, hassas, yuvarlak, parlak çaloşma
- Dayanıklı izolasyon kaplaması.
- Güvenilir fişli bağlantı.

Features

- Slim, delicate, rounded, polished working tips.
- Durable insulation coating.
- Reliable plug-in connection.

Izoleli
Insulated



2/3 mm 3/4 mm 4/5 mm

- Halka uçlar
- Dayanıklı izolasyon kaplaması.
- Güvenilir fişli bağlantı.
- Ring tips
- Durable insulation coating.
- Reliable plug-in connection.

GK 200.00 0.2 mm
GK 200.01 0.5 mm
GK 200.02 1.0 mm
GK 200.03 2.0 mm
16.5 cm
GK 200.04 0.2 mm
GK 200.05 0.5 mm
GK 200.06 1.0 mm
GK 200.07 2.0 mm
19.5 cm

GK 200.08 0.2 mm
GK 200.09 0.5 mm
GK 200.10 1.0 mm
GK 200.11 2.0 mm
22 cm

GK 202.00 1.0 mm
16.5 cm
GK 202.02 1.0 mm
19.5 cm
GK 202.04 1.0 mm
22 cm

GK 213.00 2/3 mm
GK 213.01 3/4 mm
GK 213.02 4/5 mm
19.5 cm
GK 215.00 2/3 mm
GK 215.01 3/4 mm
GK 215.02 4/5 mm
23.5 cm



Yapışmaz/Non sticking

Izolesiz
Non-insulated



GK 180.00 0.7 mm
16 cm
GK 180.01 1.0 mm
18.5 cm
GK 180.02 1.0 mm
20 cm

Izolesiz
Non-insulated



GK 184.00 1.0 mm
21 cm

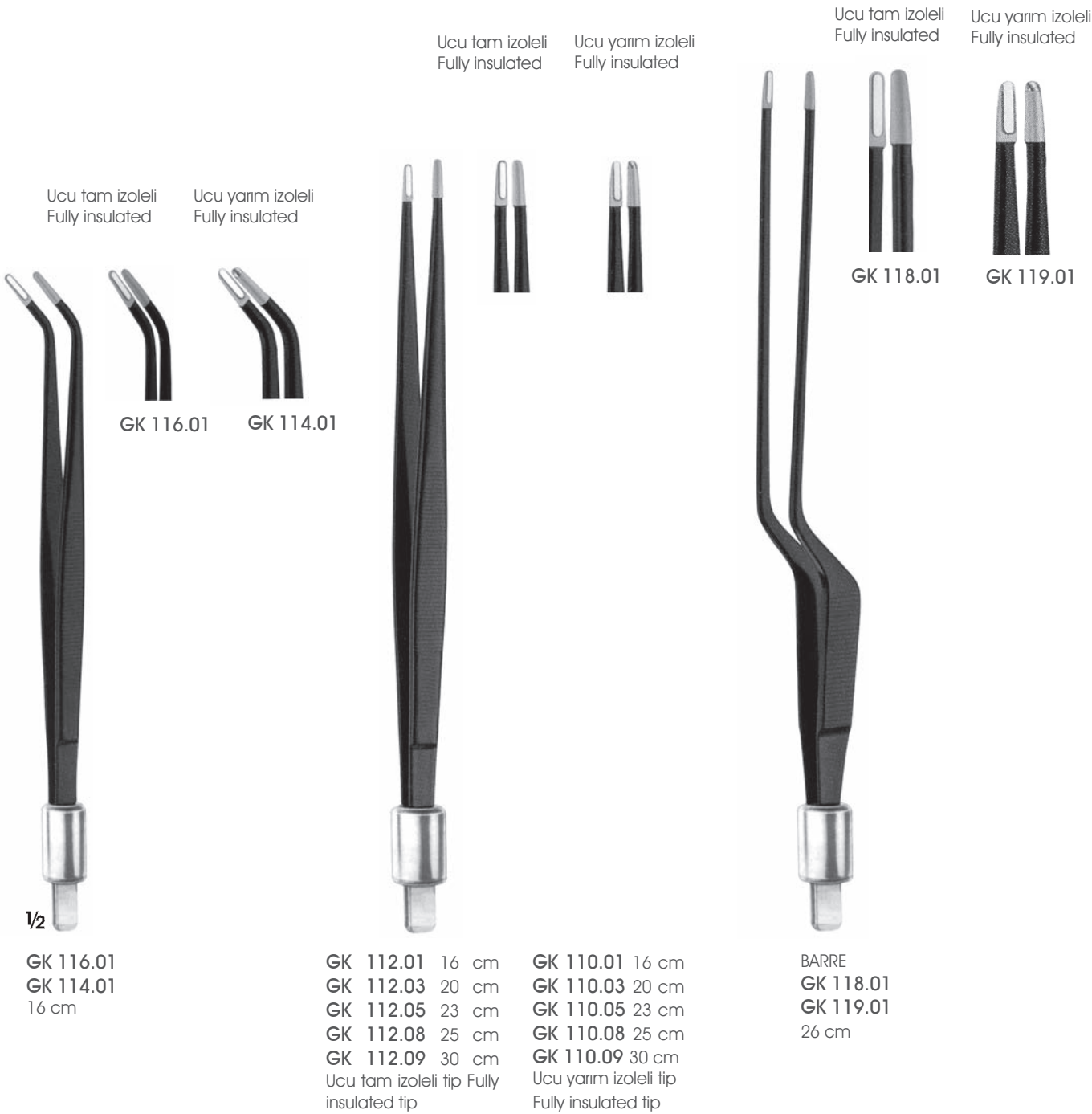

Izoleli/Insulated

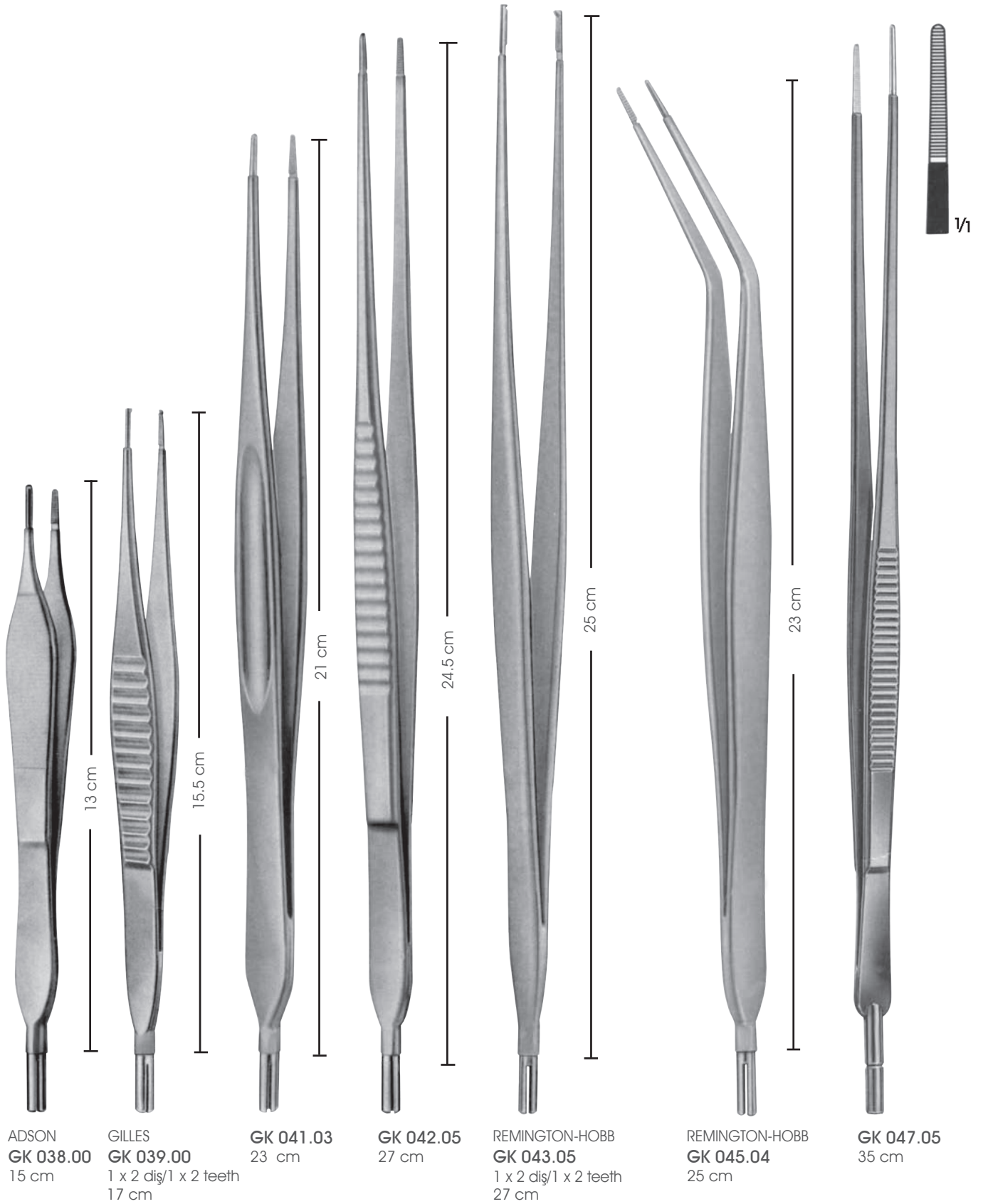



GK 230.00 18 cm
GK 230.01 20 cm
GK 230.03 24 cm
GK 230.05 30 cm
izoleli/Insulated



GK 231.00 18 cm
GK 231.01 20 cm
GK 231.03 24 cm
GK 231.05 30 cm
izoleli/Insulated
1 x 2 disj/1 x 2 teeth



Atromatik
Atraumatic

GK 232.01 20 cm
GK 232.03 24 cm
GK 232.05 30 cm
izoleli/Insulated



GK 260.00 18 cm
GK 260.01 20 cm
GK 260.02 23 cm
Makas, İzoleli Scissors,
insulated

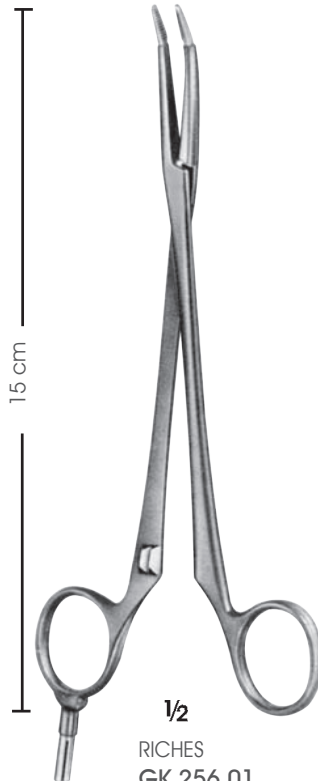

15 cm

1/2
RICHES
GK 256.01
izoleli/Insulated
17.5 cm

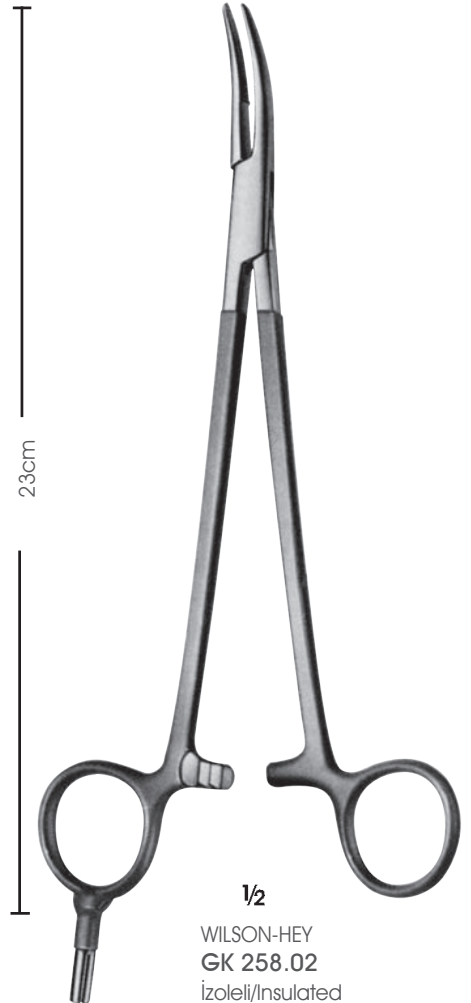

23cm

1/2
WILSON-HEY
GK 258.02
izoleli/Insulated
25.5 cm



Ø 4 mm

Ø 2.4 mm



Ø 2.4 mm **GK 017.00P**
Ø 4.0 mm **GK 017.02P**
Bıçak elektrotları
Knife electrodes



Ø 2.4 mm **GK 018.00P**
Ø 4.0 mm **GK 018.01P**
Kesme elektrotlar
Cutting electrodes



Ø 2.4 mm **GK 019.00P**
Ø 4.0 mm **GK 019.01P**
Kesme elektrotlar
Cutting electrodes



Ø 2.4 mm **GK 020.00P**
Ø 4.0 mm **GK 020.01P**
Kesme elektrotlar
Cutting electrodes



Ø 2.4 mm **GK 021.00P**
Ø 4.0 mm **GK 021.01P**
İğne elektrotlar
Needle electrodes



Ø 2.4 mm **GK 022.00P**
Ø 4.0 mm **GK 022.01P**
Halkalı elektrotlar
Loop electrodes

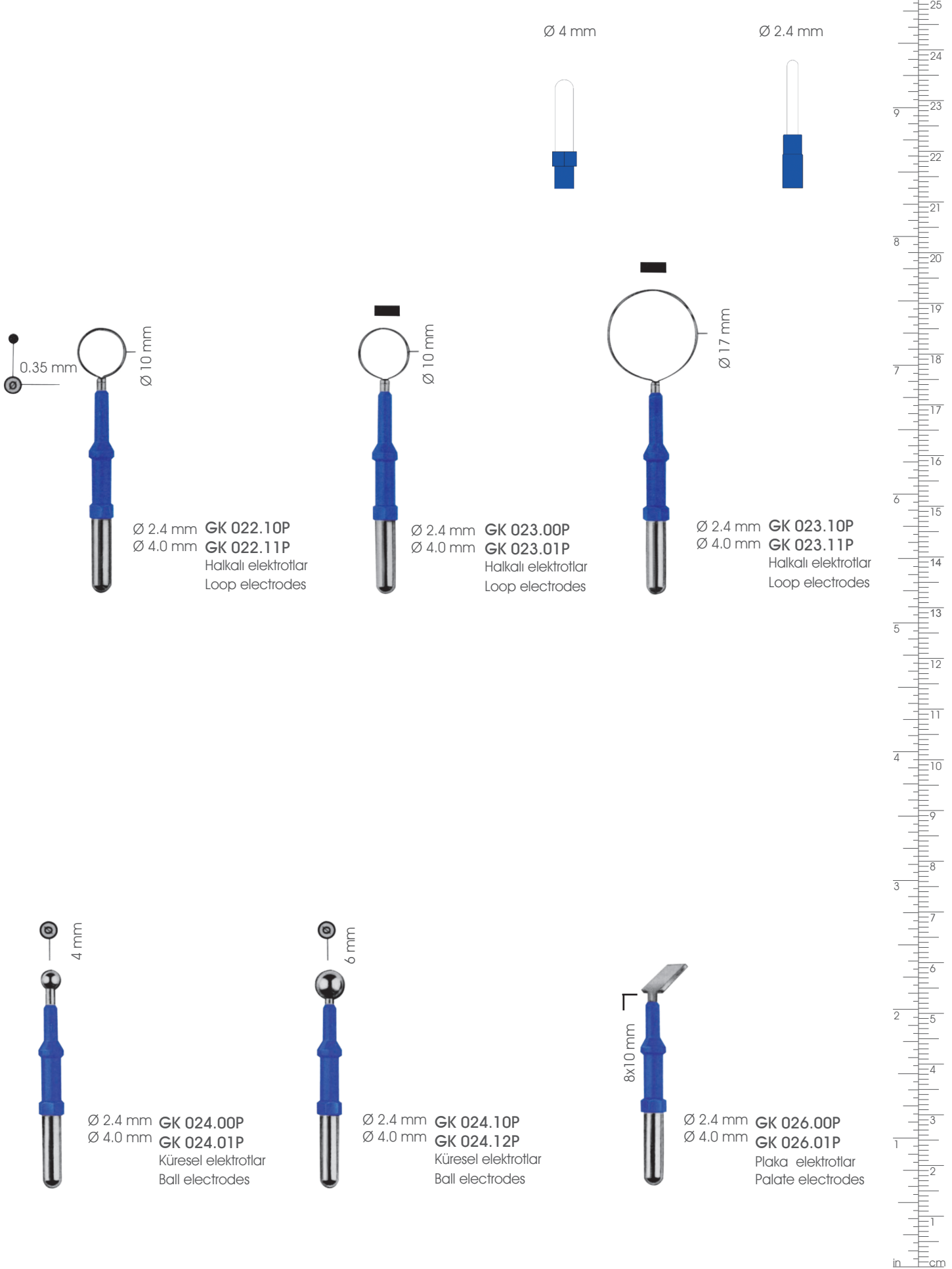

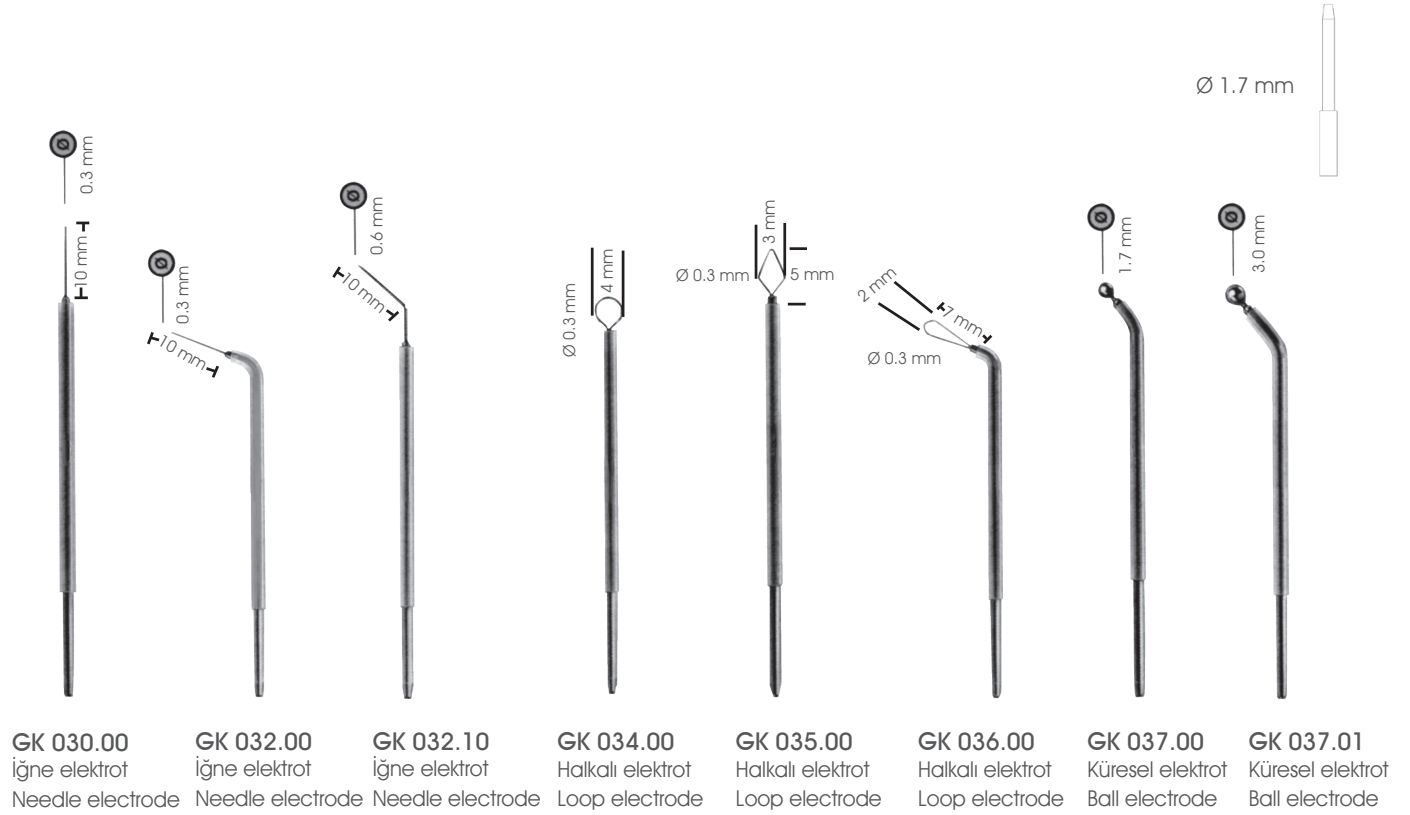

GK 097.01 Komplete/Complete
 12 adet cerrahi elektrot/Surgical lead of 12
 (GK 017.00P-GK 018.00P-GK 019.00P-GK 020.00P
 GK 021.00P-GK 022.00P-GK 022.10P-GK 023.00P
 GK 023.10P-GK 024.00P-GK 024.10P-GK 026.00P)
 1 adet konteyner (GK 096.00)/1 each container
 1 adet rak (GK 098.03)/1 adet rack

GK 097.02 Komplete/Complete
 12 adet cerrahi elektrot/Surgical lead of 12
 (GK 017.02P-GK 018.01P-GK 019.01P-GK 020.01P
 GK 021.01P-GK 022.01P-GK 022.11P-GK 023.01P
 GK 023.11P-GK 024.01P-GK 024.12P-GK 026.01P)
 1 adet konteyner (GK 096.00)/1 each container
 1 adet rak (GK 098.03)/1 adet rack

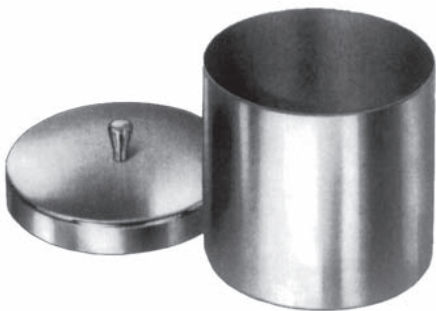

GK 096.00
 Kapaklı elektrot konteyneri
 Container with lid for electrodes



GK 098.01
 Mikro cerrahi elektrotlar için rak
 Rack for micro electrodes

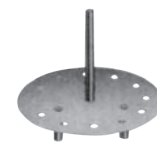

GK 098.03
 Cerrahi elektrotlar için rak
 Rack for surgery electrodes



GK 001.00
Oval kesme elektrodu
Cutting electrode
Boy/Length 30 mm
En/Wide 3.5 mm



GK 002.00
Açılı kesme elektrodu
Angled cutting electrode
Boy/Length 14 mm
En/Wide 1.8 mm



GK 003.00
Kesme elektrodu, hassas
Cutting electrode, delicate
25 mm



GK 004.00
Bıçak elektrod
Knife electrode
25 mm



GK 005.00
Bıçak elektrod
Knife electrode
18 mm



GK 010.00
Plaka elektrod
Plate electrode



GK 006.00
Halkalı elektrot
Loop electrode
Ø 10 mm
Tel Ø 3 mm/Wire Ø 3 mm



GK 009.00
Halkalı elektrot
Loop electrode
Ø 15 mm



GK 012.00
Açılı halkalı elektrot
Angled loop electrode
Ø 8 mm



GK 015.00 Ø 2.5 mm
GK 015.01 Ø 4 mm
GK 015.02 Ø 6 mm
Küresel uçlu elektrotlar
Ball point electrodes



GK 016.00 Ø 0.3 mm
GK 016.01 Ø 0.5 mm
GK 016.02 Ø 0.7 mm
İğne elektrotlar
Needle electrode 25 mm



GK 095.00 Komple/Complete
Cerrahi elektrotlar-Surgical electrodes
Ø 4 mm

12 Elektrotluk ray
Rack for 12 surgical electrodes
(GK 001.00-GK 002.00-GK 003.00-GK 004.00-
GK 005.00 GK 006.00-GK 009.00-GK 010.00-GK
012.00-GK 015.00 GK 015.01-GK 016.00)



GK 096.00
Kapaklı elektrot konteyneri
Container with lid for electrodes
25 cm

GK 097.00 Komple/Complete
GK 095.00 - GK 096.00



Ø 2.4 mm

Ø 4.0 mm



GK 052.01
Bıçak elektrot
Knife electrode

GK 052.03
Bıçak elektrot
Knife electrode

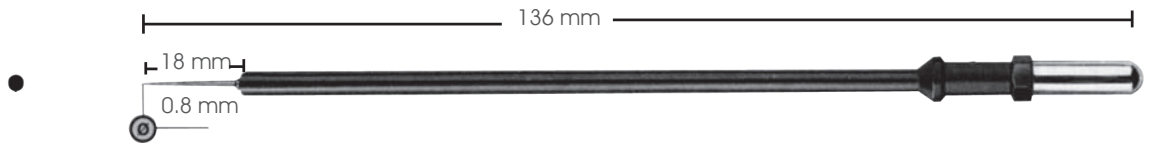

GK 051.01
İğne elektrot
Needle electrode

GK 051.03
İğne elektrot
Needle electrode

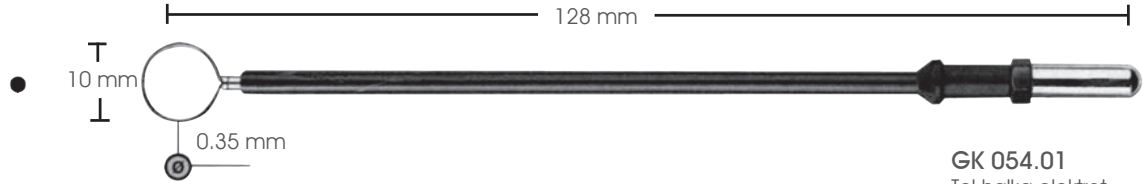

GK 054.01
Tel halka elektrot
wire loop electrode



GK 055.01
Küre elektrot
Ball electrode

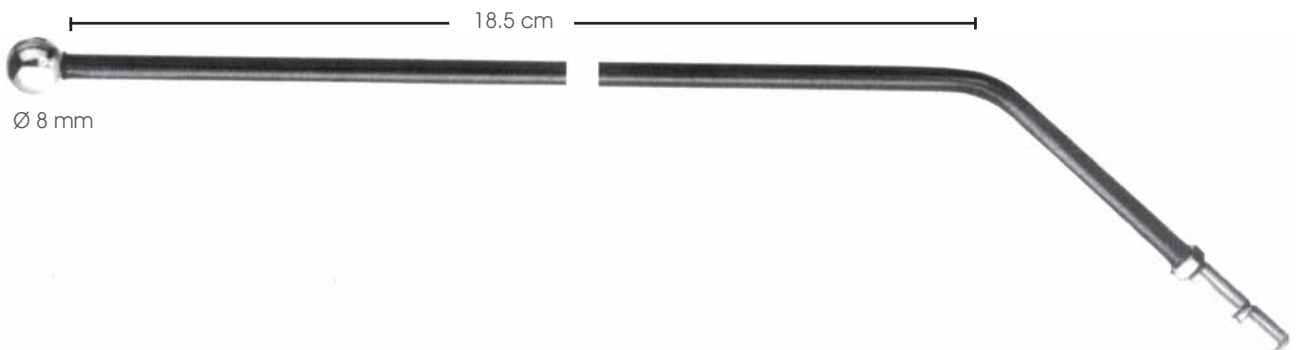

GK 046.00

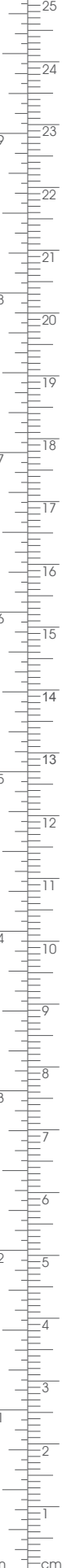
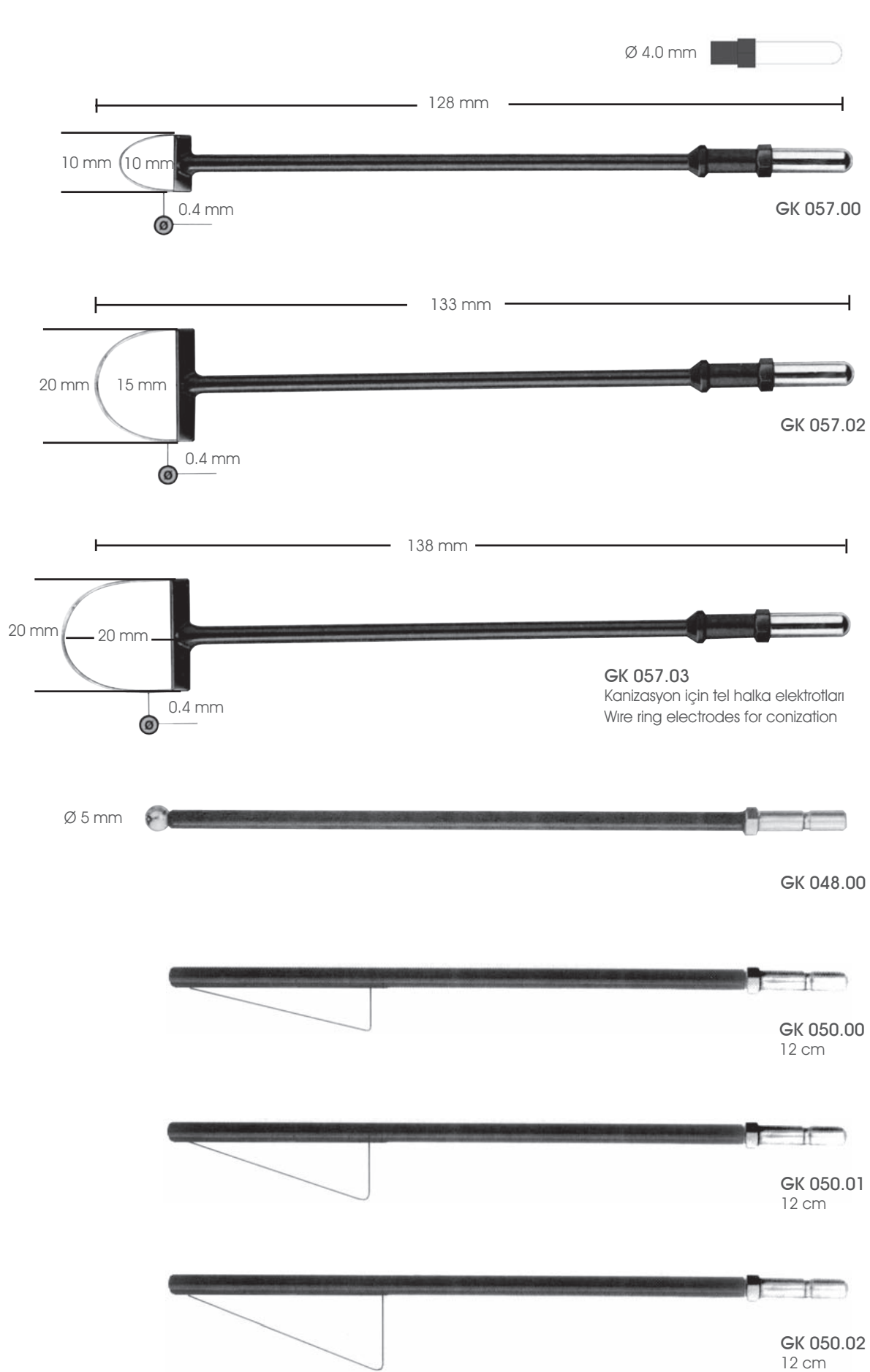

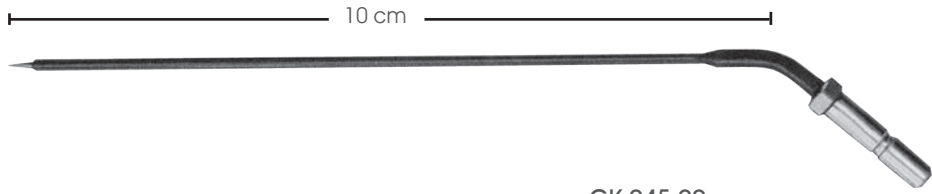

GK 045.00
Burun için iğne elektrot
Needle elektrode for nasal concha



GK 040.00
İğne elektrot
Needle elektrode



GK 041.00
Bıçak elektrot
Knife elektrode



GK 043.00
Halkalı elektrot
Wire loop elektrode



GK 043.01
Halkalı elektrot
Wire loop elektrode



GK 044.00
Halkalı elektrot
Wire loop elektrode
10 x 10 mm



GK 044.01
Halkalı elektrot
Wire loop elektrode
15 x 15 mm



GK 044.02
Halkalı elektrot
Wire loop elektrode
20 x 20 mm



GK 060.00
Elektrot tutucusu
Electrode holder

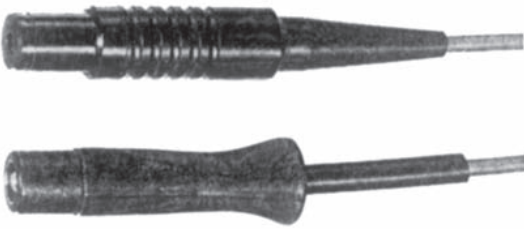

GK 309.00
Ayrılabilir aletler için kablo
Instrument cable for detachable

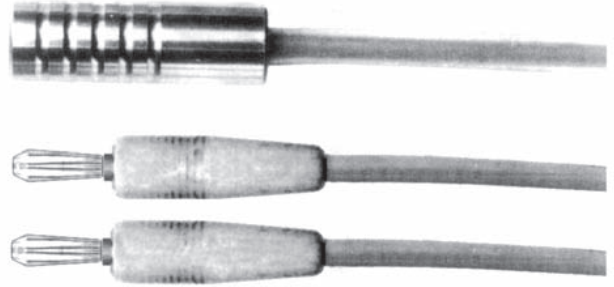

GK 065.00
Bipolar kordon
Bipolar cord
2 mt.



ABBEY
GK 270.00
Mukuzaya iğne
Mucosa needle

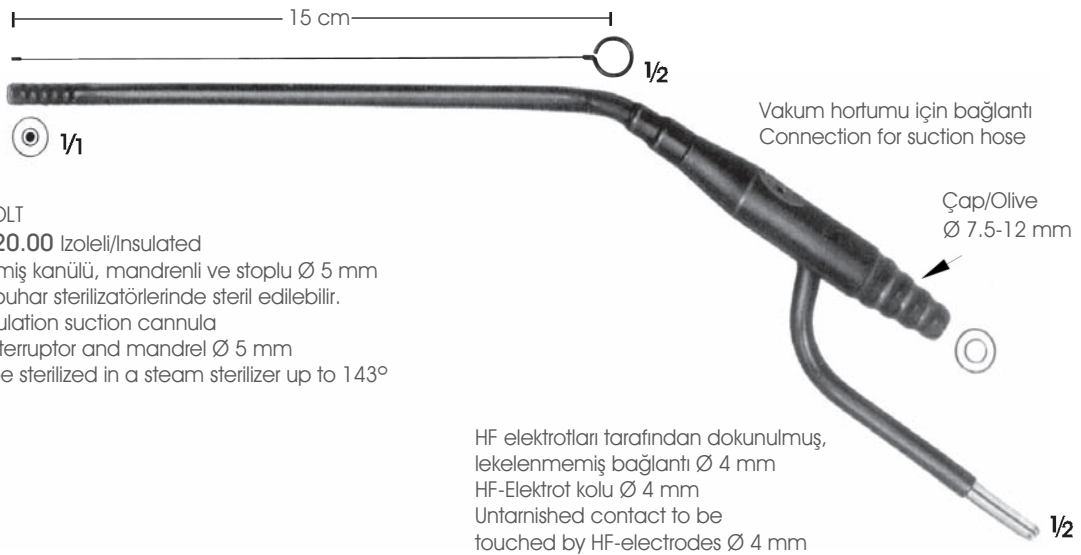

LANDOLT
GK 620.00 İzoleli/Insulated
Pıhtı emiş kanülü, mandrenli ve stoplu Ø 5 mm
143° buhar sterilizatörlerinde steril edilebilir.
Coagulation suction cannula
with interruptor and mandrel Ø 5 mm
Can be sterilized in a steam sterilizer up to 143°

HF elektrotları tarafından dokunulmuş,
lekelenmemiş bağlantı Ø 4 mm
HF-Elektrot kolu Ø 4 mm
Untarnished contact to be
touched by HF-electrodes Ø 4 mm

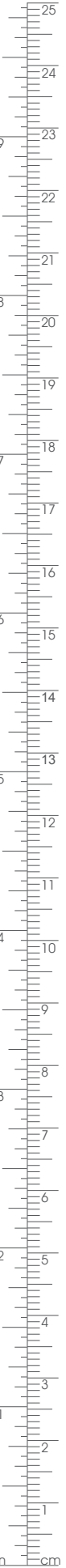

TS Taslar, Böbrek Tasları
Bowls, Kidney Trays



 **ARGENT**



JG 901.00
0.05 LT.



JG 902.00
0.1 LT.



JG 903.00
0.25 LT.



JG 904.00 0.02 LT.
4.0 x 2.8 x 1.9 cm
JG 904.01 0.06 LT.
6.1 x 4.2 x 3.0 cm
JG 904.02 0.16 LT.
8.3 x 5.4 x 4.1 cm
JG 904.03 0.4 LT.
11.1 x 7.2 x 5.6 cm
JG 904.04 1.0 LT.
15.1 x 10.0 x 7.3 cm
JG 904.06 2.5 LT.
21.1 x 14.5 x 9.6 cm



JG 900.01
175 x 100 x 35 mm
JG 900.02
205 x 115 x 40 mm
JG 900.03
255 x 145 x 40 mm
JG 900.04
275 x 155 x 45 mm



JG 905.00
1.0 LT.

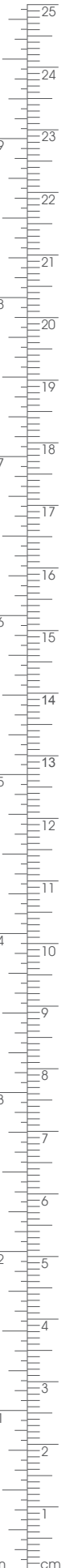

1/3

CHEATTLE
JG 500.00
28 cm



JG 514.00 20 cm
JG 514.01 30 cm



1/2

ROGGE
JG 518.00
23.5 cm

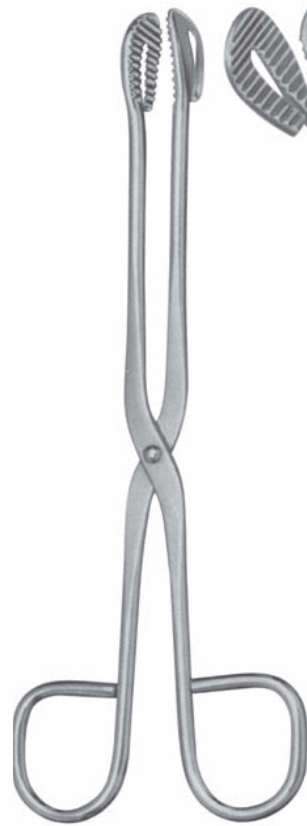

JG 510.00 20 cm
JG 510.01 30 cm



E 511.00
30 cm

1/1

A-Z

Alfabetik İndeks
Alphabetical Index

 ARGENT

A		AUSTIN , mikro sütür bağlama pensi	99
ABBEY, mukuza iğne	863	AUVARD, vajinal spekulumlar	523
Abdominal makaslar	62	Ayna	758
ABEL, uterin tenekulum pensi	536	Ayna sapları	1, 6, 58
ABRAHAM, tonsil bıçağı	17	B	
Açı ölçer	7	BABCOCK, organ ve doku tutma pensleri	148, 149
ADAIR, uterin tenekulum pensi	534	BABY-CRILE-WOOD, HARDTIPS portegü	177
ADLERKREUTZ, damar ve tümör pensetleri	120	BABY-ADSON, diseksiyon ve dikiş pensleri	235
ADSON, aspiratör uçları	306	BABY, ALLIS, doku tutma pensleri	146
bayonet penset	112	BABY-COLLIN batın ekartörler	420
doku penseti	114	BABY-CRILE, hassas hemostatik pensler	219
elektrocerrahi aletleri	854	BABY-KOCHER, bağırsak klempleri	439
HARDTIPS diseksiyon penseti	124	BABY-METZENBAUM, diseksiyon makasları	50
hassas diseksiyon pensetleri	102	HARDCOATED, HARDTIPS diseksiyon makası	94
hassas doku pensetleri	115	HARDTIPS diseksiyon makasları	85
hassas doku pensetleri, Titanyum	129	HARDTIPS diseksiyon makasları, Gripcut	90
hassas hemostatik pensler	222	Supercut diseksiyon makasları, Gripcut	92
hassas pensetler	114, 838	BABY-MIKULICZ, periton pensi	246
kemik pançı	748	BABY-MIXTER, diseksiyon ve dikiş pensleri	235
kemik ronjuru	712	BABY-OVERHOLT, diseksiyon ve dikiş pensleri	235
otomatik ekartörler	399	BABY-ROUX, ekartör	336
otomatik laminektomi ekartörler	403, 405	BABY-SENN-MILLER, ekartörler	332
perforatör	747	BACKHAUS, çamaşır klempleri	156
portegü	172	BACKHAUS-KOCHER, çamaşır klemp	156
raspalar	621, 624	Bağırsak makası	59
sinir ve damar hukları	320	Bağırsak ve kırıldak makasları	835
ADSON-BABY, otomatik ekartörler	399	BAILEY, göğüs ekartörleri	608
ADSON-BROWN, dişli doku penseti	115	BAINBRIDGE, bağırsak klempleri	438
Ağırlıklar	798	BAKES, dilatörler	480
Ağız açıcılar	3	BALFOUR, batın ekartörleri	424, 425
Alçı ayırıcılar	797	BALFOUR-BABY, batın ekartör	423
Alçı kesme makası	75, 794	BALLANTINE, otomatik ekartör	410
Alçı ve kumaş makası	76, 795	BANE-HARTMANN, kemik ronjuru	711
Alet tablası	774	BARNES-NEVILLE, doğum pensi	570
ALEXANDER, gujlar	657	BARPE, damar ve beyin cerrahi makası	70, 498
kemik ronjuru	710	BARRAQUER, mikro portegüleri	163
raspa	597, 626	otomatik ekartör	394
ALLEN, bağırsak klemp	438	BARRE, bipolar penset	499
osteofit keski ve raspa	621	bistüri sapları	22
ALLENBERG, ATROMATİK hemostatik pensler	276	diseksiyon ve dikiş pensleri	241, 498
buldog klemp	605	BARRON, aspiratör uçları	308
iliak ekartörler	431	hemoroid ligatür konik yükleyici	470
otomatik ekartörler	401	hemoroid ligatür mili	470
penset	431	hemoroid ligatür sapı	470
ALLIS, arter tutma pensi	146	hemoroid ligatürü	470
ATROMATİK organ pensleri	147, 459	BARSKY, ince yara ekartörü	324
organ ve doku tutma pensleri	147, 148	BART, kemik küreti	676
ALLIS THOMS, organ ve doku tutma pensi	148	Batın ekartörleri	420-422
ALLISON, ciğer spatulaları	363	Batın ekartörü (zincir ve ağırlık)	388
ALLPORT, otomatik ekartör	395	Batın ekartörü, ağırlık	388, 524
ALM, otomatik ekartörler	395	Batın ekartörü, zincirli	388
Alyan T kol	817	Batın ve bağırsak malaları	390, 750
Amputasyon testere bleydi	832	BAUMGARTNER, HARDTIPS portegü	177
Amputasyon testeresi	832	HARDTIPS tel bükücü	182, 802
Ampütasyon bıçakları	831	portegü	170
Anahtarlar	662, 671, 746, 812, 813, 845	Bayonet pensetler	112
ANGEL, tel kesme pensi	805	BEACHAM, amniyotom	565
Antrum pançı	778	Bebek tırnak makası	1, 4, 78
Aort pançlar	604	BECK, ronjur	736
Aproksimatör	211, 845	BECKMANN-ADSON, otomatik laminektomi ekartörler	404
ASCH, kaşık küreti	502, 550	BECKMANN-EATON, otomatik laminektomi ekartörü	405
Aspiratör kanülleri	313	BEEBE, tel kesme makasları	79
Aspiratör sapı	313	BEHRMAN, uterin kanülleri	562, 563
Aspiratör uçları	307, 309-313	BELLUCCI, aspiratör uçları	308
ASSMUS, sonda	755, 826	BENGOLEA, hassas hemostatik pensler	224
ATROMATİK bronş pensler	284, 452	BENNETT, özel kemik elevatörler	645
buldog klempler	216	BENSAUDE, anoskoplar	465
hemostatik pensler	260	BENSON, mide klemp	450
koarktasyon klempleri	295	BERGER, biyopsi pensleri	553
organ ve doku tutma pensleri	143, 473, 543	BERGMANN, alçı kesme makası	75, 794
ultra hafif pensetler	108		
AUFRIEHT, kemik törpüsü ve raspaları	690		

bıçak	14	kılavuz sondaları	200
çekiç	672, 673, 835	ligatür iğneleri	200, 810
yara ve soluk borusu ekartörü	325	sigmoid anastomoz pensi	452
BERKELEY-BONNEY , histerektomi hemostatik pens	251	sütür aleti, ligatür iğnesi	199
BERLIN , biyopsi küret	550	BRUNS , alçı makası	76, 795
BERNHARD , uterin tenekulum pensi	156, 534	kemik küretleri	678, 682
BERRY , HARDTIPS tel bükücü	182, 802	BRÜNINGS , biyopsi pens kanülleri	555
BETHUNE , göğüs makası	609	dil basacağı	2
BEYER , kemik ronjurlar	711, 713	ronjurlar	733
Beyin kaşıkları	750, 751	BRYANT , spanç ve pansuman pensi	134
Beyin şantları	748	BUCHWALD , dil basacağı	2
Bıçaklar	14, 15	BUCK , pamuk aplikatörü	302
BIEMER , aproksimatör	211, 845	BUCK-GRAMCKO , kemik elevatörleri	636
damar klipsler	210, 847	BUELAU , trokarlar	316
damar klipsleri için penset	210	Buldog klempler	215, 605
mikro damar klipsleri	208	BUMM , plasenta ve ovum küretleri	559
proksimatörler	211, 845	uterin kaşıklar	558
sinir ve damar huku	754	BUNNELL , el matkabı	813
BIEMER-MÜLLER , aproksimatörler	209, 845	tendon stripperler	827
BIER , amputasyon testere	833	BUNT , alet askısı	159
amputasyon testere bleydleri	833	BURKE , histerektomi pensleri	255, 549
amputasyon testere sapı	833	BUSHE , kemik küretleri	680
BIRCHER-GANSKE , menisküs pensleri	818	BÜCHS , ekartör	355
BIRKETT , hassas hemostatik pensleri	223	raspa	624
BISHOP-HARMON , hassas göz penseti	114	Bükme kolları	816
Bistüri sapları	22-24, 499, 546	Bükme ve kıvrıma aparatı	816
Bistüri sapı, mikrocerrahi bıçaklar için	767		
Biyopsi pens sapı	468, 555	C	
Biyopsi pensi	468, 469, 554	CAIRNS , dura ekartör	322
BLAKE , safra taşı pensleri	482, 602	hassas hemostatik pensleri	219, 220
uterin küret	560	CAIRNS, DOTT , hassas diseksiyon pensetleri	105
Bleyd tutma pensi	416	CAIRNS , elevator	634
Bleyd tutucu	417, 790, 791	CAMPBEL , sinir ve sinir kökü ekartörü	334
BLOUNT , ekartör	350, 819	CANNY-RYALL , ekartörler	338
özel kemik elevatörü	647	CARREL , hassas hemostatik pens	218
BLUMENTHAL , kemik ronjurları	709	CARTER , raspa	616
BOER , plasenta ve ovum pensi	575	CASPAR , bistüri sapı	24
BONNER MODELL , mikro sütür bağlama pensi	99	disektör	615, 760
BONNEY , diseksiyon penseti	107	düğüm aparatı	204, 755
doku penseti	122	ekartör	355
polipus ve ovum pensi	545	iticiler	669
BOROWSKI , aort kapağı ekartörleri	595	kemik küretleri	686, 687
BOSE , otomatik ekartör	394	mikro bıçaklar	767
yara ve soluk borusu ekartörleri	325	mikro disektörler	760
BOWMAN , sondalar	302	otomatik ekartörler	413-416
BOZEMANN , rahim makası	61	raspalar	615, 623, 759
uterin pansuman pensleri	532, 533	ronjurlar	738, 741, 743
vajinal spekulumlar	524	sinir ve damar hukları	321, 757
BOZEMANN-DOUGLAS , uterin pansuman pensi	533	sinir ve sinir kökü ekartörleri	334, 416
Böbrek tasları	864	CASTANEDA , ATROMATİK anastomoz ve çok amaçlı klempler	263
BÖHLER , kemik kesme pensleri	719	CASTROVIEJO , göz makasları	29
kemik ronjurları	713	HARDTIPS mikro portegüler	164
Bölücü için sürgülü raylar	527	hassas göz penseti	114
BRAITHWAITE , cilt nakil bıçağı, kesicisiz	21	mikro portegüler	162
BRAND , tendon tutucu pensler	145	CATLIN , amputasyon bıçağı	18, 831
BRAUN , organ ve doku tutma pensi	151, 539	CAWTHORNE , pamuk aplikatörü	302
uterin bastırıcı	531	Cement çıkartıcılar	823
uterin tenekulum pensi	534	Cement iticiler	822
vajinal spekulumlar	518	Cerrahi makaslar	41-44
BRAUN-STADLER , bandaj makası	73	Cetveller	7
epizyotomi makasları	73, 567, 606	CHADWICK , hassas makas	39
BREISKY , vajinal spekulumlar	516, 520	CHAMPIONNIERE , kemik matkabı	811
BRIDGE , hassas hemostatic pensler	225	CHANDLER , kemik elevatörleri	628
BRISTOW , kemik elevatörü	635	CHAPUT , arter tutma pensi	146
BROCK , mikro sütür pensetler	101	CHARNLEY , doku penseti	122
BRODIE , sonda	300, 472	CHARRIERE , amputasyon testere bleydleri	832, 833
BROM , sinir ve damar huku	320	amputasyon testere sapı	833
BROPHY , doku penseti	118	amputasyon testere	832
hassas diseksiyon pensetler	104	CHEATLE , sterilizasyon pensi	159, 865
BROWN , hassas doku pensetleri	115	CHERON , spanç ve pansuman pensi	139
BRUNNER , ekartörler	365, 367, 368, 386	CINELLI , osteotomları	659
göğüs makası	609		

CITELLI, pañçlar	722	osteotomlar	657, 779
Cilt dođrutma plađı	20, 841	raspalar	619, 623
CLAUS VAN EICKEN, stur aleti ligatr iđn	199	COTTLE-KNAP, plastik cerrahi makaslar	50
CLOWARD, anahtar	789	COTTLE-MASING, plastik cerrahi makası	47
akma bařlıđı	789	CRAFOORD, hassas hemostatic pensler	225
ekiler	670, 788	CRAIG, ronjurlar	732
derinlik ler	789	CRAIG-DOMNICK, ronjur	732
ekartrler	418, 786, 788	CRILE, ekartr	335
ekartr bleydleri	418, 786	hassas hemostatik pensler	220, 221
elevatrler	788	porteg	175
greft alma kolu	789	sinir ve damar huku	320
greft alma matkapları	789	CRILE-MURRAY, porteg	171
greft tutma uları	789	CRILE-WOOD, HARDTIPS portegler	178
kol ii apı	789	portegler	171
koruyucu kilavuzları	789	CRUCHFIELD, kafa traksiyon aletleri	746
koter huku	788	CUSCO, vajinal spekulumlar	509, 510
lamina ayırıcılar	419, 787	CUSHING, doku penseti	118
matkap kolları	789	HARDTIPS diseksiyon penseti	125
matkap koruma bařlıđı	789	hassas diseksiyon pensetler	104, 838
matkap koruyucular	789	hassas diseksiyon pensetler, Titanyum	130
matkap uları	789	perforatrler	747
merkezleme pimleri	789	ronjurlar	737, 739
osteotom	788	sinir ve damar hukları	320
tutma kolları	789	yara ve damar ekartrler	331
COBB, gujlar	668	CUSHING-KOCHER, yara ve damar ekartr	331
raspalar	628, 629	CUSHING-LANDOLT, hipofizektomi spekulumları	779
COBBETT, cilt nakil bıađı	21	CZERNY, doku ve organ tutma pensi	151, 540
COBRA, kemik elevatrleri	645	ekartr	339
COCK, rektal spekulum	464	rektal spekulum	462
COLLER, hassas hemostatik pensler	221	safra tařı pensi	482
COLLIN, bađırsak tutma pensleri	150		
batın ekartrler	420, 422		
bbrek alma pensi	491, 545	amařır klempleri	155, 157, 158
dil pensleri	01, 08, 41, 141	amařır pensleri	159, 865
ekartr	335	ekiler	670, 671, 673, 823
gbek kordonu klempi	567	eki, yedek diskler	671
klip ıkarıcı pens	204		
organ ve doku tutma pensleri	143	D	
span ve pansuman pensi	139	DAHLGREN, dura koruyucu	749
uterin ıkartma pensleri	544, 545	huk	749
uterin kret	560	Damar makasları	29, 70, 477
vajinal spekulumlar	508	Damar ve beyin cerrahi makasları	69
COLLIN-HARTMANN, ekartr	339	DANDY, hassas hemostatik pensler	220
COLLIN-POZZI, uterin tenekulum pensi	534	DARDIK, ATROMATİK ok amalı klempler	285
CONE, laminektomi ekartr	401	DARLING, otomatik laminektomi ekartrler	407
CONVERSE, HARDTIPS porteg	177	DARTIGUES, bbrek alma pensi	491, 544
ince yara ekartr	324	DAUBENSPECK, kemik kretleri	680
porteg	170	DAVIDSON, krek ekartrler	366
COOLEY, atrium ekartrler	592-594	DAVIS, disektr	596, 614
ATROMATİK anastomoz ve ok amalı klempler	264, 265, 292	raspa	614
ATROMATİK anastomoz klempler	288, 290, 293	DE BAKEY, arteriyotomi makası	49
ATROMATİK aort klemp	297	aspiratr kanlleri	314, 607
ATROMATİK buldog klempler	286, 287	ATROMATİK anastomoz ok amalı klempler	264
ATROMATİK ok amalı klempler	289, 296	ATROMATİK diseksiyon ve ligatr pensler	282
ATROMATİK koarktasyon klempler	294	ATROMATİK sigmoid anastomoz pensi	273, 454
ATROMATİK pensetler	108	ATROMATİK tanjensiyel oklzyon klempler	268
damar ve beyin cerrahi makası	70	ATROMATİK aort anastomoz klemp	280
hassas diseksiyon penseti	105	ATROMATİK aort anevrizma klempler	274-276
sternum ekartrler	587	ATROMATİK aort klemp	278
COOLEY-BECK, ATROMATİK anastomoz klempler	288	ATROMATİK buldog klempler	217, 262
COOPER, cerrahi makaslar	42	ATROMATİK ok amalı klempler	272
stur aleti, ligatr iđnesi	199	ATROMATİK duktus klempler	269
CORYLLOS, ciđer spatulaları	364	ATROMATİK koarktasyon klempler	271
COTTLE, bayonet penset	112	ATROMATİK mikro pensetler	108
burun spekulumları	778	ATROMATİK pensetler	108, 109, 459
eki	672, 779	ATROMATİK pensetler, Titanyum	131
diseksiyon makası	46	ATROMATİK periferik damar klempler	269, 270
dura ekartr	323	ATROMATİK ultra hafif penset	131
ekartrler	329, 330	damar dilatrleri	600, 601
ince yara ekartr	322	gđs ekartrleri	583, 585
keski	657	HARDTIPS damar makası	84, 477
keski ve osteotom	657		

HARDTIPS portegüler	178, 179	myoma burguları	546
kalça kemiği ekartörü	408	portegü	171
kardiyovasküler makaslar	67, 68	raspalar	598, 632
sternum ayırıcılar	586	sonda	300
TİYANYUM ultra hafif penset	131	vajinal spekulumlar	522
DE BAKEY-BAINBRIDGE, ATROMATİK hemostatik pens	260	yanal spekulumlar	522
DE BAKEY-BECK, ATROMATİK vena kava klempier	267	DUBOIS, rahim makasları	64
DE BAKEY-HARKEN, ATROMATİK vena kava klempier	267	DUNHILL, hassas hemostatik pensler	218, 223
DE BAKEY-HESS, buldog klempier	214	DUPLAY, spanç ve pansuman pensleri	135
DE BAKEY-KELLY, ATROMATİK hemostatik pens	260	uterin tenekulum pens	536
DE BAKEY-MC QUIGG-MIXTER, ATROMATİK bronş klemp	281	Dura ekartör	323, 757
DE BAKEY-MIXTER, ATROMATİK diseksiyon ligatür pens	283	Dura ve cilt ekartörü	324, 757
DE BAKEY-PEAN, ATROMATİK hemostatik pensler	261	DURHAM, ekartör	352
DE BAKEY-RUMEL, ATROMATİK diseksiyon ligatür pensler	283	DUVAL, bağırsak penseti	122
DE BAKEY-SATINSKY, ATROMATİK tanjensiyel oklüzyon klempier	268	bağırsak tutma pens	150
DE LEE, pelvimetre	564	DUVAL, COLLIN, organ ve doku tutma pensleri	149
DE MARTEL, kondüktör	749	Düğüm aparatı	204
DE MARTEL-WOLFSON, anastomoz klempier	450		
kapama pens	450	E	
DE VILBISS, dura koruyucu	749	EAST GRINSTEAD (WARD), keskiiler	658
DEAVER, cerrahi makaslar	45	EAST GRINSTEAD, osteotomlar	658
ekartörler	369-374	EASTMAN, keskiiler	658
Delikli tepsiler	528	vajinal spekulum	518
Delme başlıkları	812	ECHLIN, kemik ronjuruları	714
DEMEL, tel kılavuzları	800	Ekartörler	329, 346, 351, 365, 649-655, 845
tel bükme pens	801	Ekartör tutucu mil	771, 773
DENIS-BROWNE, bağırsak penset	122	Ekartör yerleştirme kolu	414
batın ekartörler	428	Ekartörler, esnek kol	774
DERF, HARDTIPS portegü	177	Ekartör, masa bağlantı mafsalları	771, 773
portegü	170	Ekartör, pens tutucu	773
Derinlik ölçerler	814	Ekartör, tutma ve sabitleme elemanları	770, 774
DERRA, ATROMATİK anastomoz ve çok amaçlı klempier	265	El matkabı	813
DERRA, COOLEY, ATROMATİK anastomoz klempier	289	El sabitleyicileri	824
DESCHAMPS, sütür aletleri, ligatür iğnesi	194-197	El vanası ve bağlantı borusu	561
DESJARDINS, diseksiyon ve dikiş pens	244, 476	Elektrocerrahi aletleri	848-855
safra kanalı sondaları	478	Elektrotlar	856-862
safra taşı kaşıkları	479	Elektrot kabloları	863
safra taşı pensleri	483	Elektrot konteyneri	858, 859
DESMARRES, ekartörler	330	Elektrot rakları	858
DETHRICH, kardiyovasküler makasları	67	Elektrot tutucusu	863
DIAMOTE mikro pensetler	125, 126, 127	Elevatör	634
DIAMOTE mikro pensetler, Titanyum	128	EMMET, ekartör	330
DIAMOTE mikro portegüler	165, 166, 168, 169	spanç ve pansuman pens	139
DIAMOTE mikro portegüler, Titanyum	167	Endarterektomi temizleyiciler	603
DICK, ATROMATİK anastomoz klempier	256, 284, 451	ENGEL, alçı testeresi	795
DIEFFENBACH, buldog klempier	214	ENGIL MOD, çamaşır klemp	155
DIETHRICH, ATROMATİK aort klemp	277	Enjeksiyon iğnesi	564
buldog klempier	215	Epizyotomi makası	73, 567
DINGMANN, kemik tutma pensleri	699	EPENDORE, biyopsi pensleri	553
DITTEL, üretral dilatasyon bujiler	504	EPSTEIN, kemik küretleri	681
DIXON-LOVELACE, hassas hemostatik pensler	222	ESMARCH, alçı bıçağı	795
Dil basacakları	1, 2, 4	alçı kesme makasları	75, 794
Dilatör	754		
Dilatörler için steril saklama parçaları	527	F	
Diseksiyon makasları	46	FAHLBUSCH, mikro kaşık	783
Diseksiyon pensetleri	106, 107, 834, 836	mikro küret	783
Diseksiyon pensetleri, Titanyum	130	Falanks bıçak	19, 830
Diseksiyon ve dikiş pensleri	235, 236	FARABEUF, ekartörler	335
Diseksiyon sinir makası	49	kemik tutma pensleri	701
Diseksiyon ve çapşılık makasları	34	raspalar	626
Diseksiyon, sinir makası	35	FARABEUF-COLLIN, raspalar	626
Disektör	615	FARABEUF-LAMBOTTE, kemik tutma pens	701
Distraktör	698, 799	FARRELL, pamuk aplikatörleri	303, 304
Diz ekartörleri	350, 351, 819	FAURE, biyopsi pensleri	551
DOCKHORN, ekartörler	355	periton ve histerektomi pensleri	247
Doku pensetleri	116-119, 834, 838	FAVOLORO, kardiyovasküler makası	68
Doku pensetleri, Titanyum	129	FEILCHENFELD, kıymık pensetler	123, 839
DOUNAY, biyopsi pens	554	Femur ekartörü	644
DOYEN, bağırsak klempier	438-441	FERGUSSON, aspiratör uçları	305
batın ekartörler	380, 382, 387, 388, 519	baskı klempier	474
çamaşır klempier	155	kemik tutma pens	700, 835
hemoroid pens	474, 543		

FERGUSSON-ACKLAND, ağız açıcı	3
FERRIS-SMITH, HARDTIPS diseksiyon penseti	125
FICKLING, çekiç	670
hemostatik pensler	232
FINECHIETTO, diseksiyon ve dikiş pensi	244
göğüs ekartörleri	580-583
torasik ekartörler	591
HARDTIPS portegü	186
FINOCHIETTO-BURFORD, göğüs ekartörleri	584
FINSEN, otomatik ekartörler	394, 395, 845
FINSTERER, sulama kanülü	315, 607
FISCH, dura ve cilt huku	324, 757
Fiber ışık taşıyıcı NAUNTON, MORGAN için	466
Fistül bıçakları	16
Fistül sonda	472
FOERSTER BALLANGER, tampon pansuman pensi	140, 474
FOMON, diseksiyon makasları	47
ekartör	329
kemik törpüsü ve raspaları	691
osteotomlar	659
FORMBY, aspiratör ucu	307
Forseps	823
FOWLER, tonsil bıçak	17
FOX, küretler	840
FÖRSTNER, pozisyon pensi	697
FRASER-KELLY(CRILE), hassas hemostatik pens	223
FRAZIER, aspiratör uçları	305
dura ekartör	322
raspa	617
FREER, guj	656
ince yara ekartörü	322
keskiler	656
raspalar	596, 614, 616, 617
FREER-YASARGIL, raspa	614
FRENZEL, dil basacağı	2
FRIEDMANN, kemik ronjurları	708
FRITSCH, batin ekartörler	383
FRYKHOLM, kemik ronjuru	714
FUCHSIG, hassas hemostatik pens	222
FUKUSHIMA DESING, aspiratör uçları	309

G	
GABRIEL, rektal spekulum	466
GALABINS, uterin sonda	531
GALLAHER, kemik törpüsü ve raspası	691
GARDNER, WELLS, kafa traksiyon aleti	746
GELPI, cilt ve vajinal ekartör	408, 525
vajinal ekartör	408, 525
GEMINI, diseksiyon ve dikiş pensleri	238
GERALD, doku pensetler	118
hassas diseksiyon pensetler	104
mikro pensetler	101
GERSTER, kemik klempi	707
GIERTZ-STILLE, göğüs makası	609
GIGLI, tel testereleler	749, 810, 832
tel testere sapı	749, 810, 832
GILLES, portegüler	174
aspiratör ucu	307
doku penseti	119
HARDTIPS portegü	181
hassas diseksiyon penseti	104
ince yara ekartörleri	323
osteotomlar	659
elektrocerrahi aletleri	854
GILSBACH, kombine ekartörler	772
kombine ekartör, bağlantı elemanları	773
kombine ekartör, yarım daire bar	772
kombine ekartör, çerçeve	772
kombine ekartör, el dayama barı	773
kombine ekartör, tutucu mil	772
ekartör sistemi	772-774

Gland ve sünnet pensi	500
GLASSER, DIAMOTE mikro portegüler	166
GLOVER, ATROMATİK anastomoz klempeler	266
ATROMATİK buldog klempeler	217
GLUCK, göğüs makası	609
GOELET, ekartör	337
GOLIGHER, batin ekartör	426
GORNEY, aspiratör disektör	311
diseksiyon makasları	51
Supercut diseksiyon makası	93
GOSLEE, tel tutma pensi	803, 815
GOSSET, batin ekartörler	423, 424
GOURDET, kemik küretleri	556, 688
Göbek dilatörü	567
Göbek kordonu makasları	72, 566
Göğüs makası	609, 835
GRAEFE, cilt ekartörleri	322
diseksiyon makası	46
hassas doku penseti	115
sinir ve damar huıkları	320
GRAVE, vajinal spekulumlar	510
GRAY, diseksiyon ve dikiş pensler	244, 475
GREEN-ARMYTAGE, sezeryan hemostatik pensler	571
GREENE, ekartör	352
GREGORY, ATROMATİK profunda klempeler	282
GREY-TURNER, hassas hemostatik pens	223
GROSS, pansuman pensler	1, 9, 35
spanç pensler	1, 9, 35
spanç ve pansuman pensler	134
GRUENWALD bayonet penset	112
diseksiyon penseti	125
Gujlar	656, 664, 666-668, 817, 822
GULEKE, kemik ronjuru	712
GUTHRIE, cilt ekartörleri	322
GUYON, böbrek klempeleri	486-488
katater için uygulayıcı	504
katater kılavuz	504
üretal dilatasyon bujileri	505
GWILLIAM, histerektomi hemostatik pensler	251

H	
HAASE, itici	669
pozisyon pensleri	696, 697
HABERER, batin ve bağırsak malası	391
mide, bağırsak pensi	449
HAIGHT, göğüs ekartörü	581
HAJEK, çekiç	670
ekartör	338
sulama kanülü	478
HAJEK-KOFLER, pançlar	723
HAKANSSON, kemik ronjuru	709
HALLE, elevatör	596, 615
kemik küretleri	680
HALSEY, HARDTIPS portegüler	176, 177
portegüler	170
HALSTED, hassas hemostatik pensler	222
HALSTED-MOSQUITO, hassas hemostatik pensler	218, 223
HARDCOATED diseksiyon makası	94
HARDCOATED diseksiyon makasları, Gripcut	95
HARDCOATED transsfenoidal spekulum	778
HARDTIPS cerrahi makaslar	80, 81
HARDTIPS cerrahi makas, Gripcut	89
HARDTIPS diseksiyon makaslar	85
HARDTIPS diseksiyon makası, Gripcut	90
HARDTIPS diseksiyon pensetler	124, 125
HARDTIPS hassas ligatür makaslar	80
HARDTIPS hassas makaslar	80
HARDTIPS histerektomi makaslar	84
HARDTIPS kemik törpüleri ve raspaları	692, 693
HARDTIPS ligatür makaslar, Gripcut	88, 89
HARDTIPS makaslı portegü	181

JOSEPH, cilt ekartörleri	323	kılavuz sondası	203
çift taraflı burun bıçakları	16	traksiyon aletleri	799
Supercut diseksiyon makasları	93	Kıymık penseti	123, 839
hassas makaslar	34, 38	KLAPP, yara ve damar ekartörü	333
kemik törpüsü ve raspaları	690	Kılavuz sondaları	203
raspa	621	KLEINERT-KUTZ, ince yara ekartörleri	323
el testeresi	825	tendon geçiş pensi	145
JUDD-ALLIS, organ ve doku tutma pensi	148	KLEINSCHMIDT, apendektomi klempi	450
		Klemp tutucular	450
K		KLIMA-ROSEGGGER, trokar	316
KADER, batin ve bağırsak malası	390	KLINIKUM BERLIN, Tüp klempi	11
Kalça ekartörü	821	KLINKENBERG, damar cerrahi makası	71
KALLMORGEN, vajinal spekulumlar	516	Klip aplikatörleri	768
Kan kaşıkları	391, 831	Klip aplikatörleri, Titanyum	769
KANTROWITZ, diseksiyon ve dikiş penleri	241	Klip aplikatör penleri	578, 579, 752
Kanüller	315, 561	KNOWLES, bandaj ve kumaş makasları	74
Katater kılavuz	504	KOCHER, bağırsak klempleri	440, 442, 443
Kavrama silikonları	655	basacak	391
KAZANJIAN, kemik kesme pensi	718	ekartörler	342, 348, 356
KEIBACK, diseksiyon ve dikiş penleri	245, 547	hemostatik penler	230
KELLY, anoskop	465	kemik ekartörleri	340
batın ekartörler	379	kılavuz sondaları	202
ekartörler	353	mesane ekartörü	495
hassas hemostatik penler	219	sütür aleti, ligatür iğnesi	199
hassas makaslar	38	yara ve damar ekartörleri	333
organ ve doku tutma penleri	142, 542, 574	KOCHER-LANGENBECK, ekartörler	345
proktoskop	466	KOCHER-OCHSNER, hemostatik penler	231
rektal spekulumlar	464	KOCHER-WAGNER, ekartörler	358
sfinteroskop	465	KOFLER, pañç	724
Kemik biyopsi trapanları	812	KOGAN, endo spekulumlar	529
Kemik ekartörü	340	Komedon ekstraktör	840
Kemik elevatörleri	636-638, 640, 641, 644, 646	KONIG, elevatörler	634
Kemik kesme penleri	718, 719	Konik uçlu delme boruları	605
Kemik küretleri	676, 677, 679, 680, 689	KOOS, mikro damar bıçakları	764
Kemik makasları	835	KÖNIG, raspa	620
Kemik pañçı	748	yara ve damar ekartörleri	331
Kemik ronjurları	708, 709	kılavuz sondaları	201
Kemik tapları	814	KÖRTE, ekartör	342, 343, 376
Kemik törpüsü ve raspaları	690, 691, 693	KÖRTE-WAGNER, ekartör	342
Kemik tutma penleri	700, 705, 706	KRAMER, ekartör	355
KERN-LANE, kemik tutma penleri	702, 703	keski	658
KERN-MINI, kemik tutma pensi	703	raspalar	624
KERPEL, kemik küretleri	683	ronjurlar	740, 743
KERRISON, HARDCOATED kemik pañçları	726, 727	KRAUSE, biyopsi pens uçları	555
kemik pañçları	726-729	trokar	316
pañçları	722, 725	KRAYENBULH, sinir ve damar hukları	321, 756
KERSTING, ATROMATİK sigmoid anastomoz pensi	455	KRISTELLER, vajinal spekulumlar	512-515, 517
Kesim uçları, biyopsi pensi için	468, 469, 555	KRONECKER, sütür aletleri, ligatür iğnesi	194
Keskiler	652, 656, 662, 663, 665	KRONLEIN, hemostatik pens	226
KEVORKIAN, biyopsi pens	554	Kumaş makası	76
KEY, raspalar	629	Kumpaslar	7
KEYES, deri pañçları	838	KUNTSCHER, oyucular	820
KIEBACK, ATROMATİK histerektomi penleri	253	KÜMMEL, ekartör	376
parametriyum makasları	60, 548	KÜSTNER, uterin tenekulum pensi	538
KIELLAND, doğum pensi	569		
Kıkırdak makası	51	L	
Kılavuzlar	815	LA GRANGE, hassas makas	40
Kılavuz kılıfı	564	LABORDE, tiroid dilatörler	409
Kılavuz pimleri	815	LAHEY, ekartör	351
KILLIAN, kemik makası	77	organ ve doku tutma penleri	151, 539
raspalar	615, 617	LAHEY(SWEET), diseksiyon ve dikiş penleri	245, 476
rektal spekulum	462	LAHGENCBEK, HARDTIPS portegüler	189
sonda	302	LAMBERT-KAY, ATROMATİK aort anastomoz klempiler	280
KILNER, diseksiyon makaslar	47	LAMBOTTE, kemik tutma penleri	706
ekartörler	332, 337	osteotomlar	659, 662
HARDTIPS portegü	177	raspalar	597, 626
hassas diseksiyon makası	46	LANCASTER, otomatik ekartör	394
ince yara ekartörleri	322, 324, 840	LANDAU, trokar	316
portegü	171	vajinal spekulumlar	520
KING'S COLLEGE HOSPITAL, pamuk aplikatörleri	302	LANDOLT, aspiratör ucu	310
KIRSCH, ekartörler	349	ayırıcı	779
KIRSCHNER, batin ekartörler	429	bistüri sapı	25

disektörler	781	Ligatür kılavuzları	756
enuklasyon makası	47	Ligatür makası	78
huk	781	LLOYD-DAVIES (GOLIGHER'S) rektal makas	58, 457
kanül	315, 863	LLOYD-DAVIES, biyopsi pensi	468
kaşık	781	LLOYD-DAVIS, sigmoid anastomoz pensi	453
küret	781	LOCKHART-MUMMERY, sondalar	300, 472
raspa	623	LOCKLIN, hassas makas	40
ronjur	740	LOCKWOOD, bağırsak tutma pensi	150
LANDOLT-REULEN, disektör	782	LOGAN-REILL, otomatik ekartör	394
huk	783	LOPEZ-REINKE, aspirasyonlu tonsil disektör	311
raspalar	783	LORNA, çamaşır klempri	158
LANDON, vajinal spekulum	518	LOUTE, tel gerici	801
LANE, çamaşır klempri	155	LOVE, sinir ve sinir kökü ekartörleri	334
doku pense/leri	120	LOVE-GRUENWALD, ronjurlar	739
ekartörler	338	LOWER, diseksiyon ve dikiş pensi	245
kemik elevatörü	635	LOWMAN, kemik klempri	707
kemik tutma pensler	702, 703	LOWMAN-GERSTER, kemik klempri	707
mide, bağırsak pensleri	448	LOWMAN-HOGLUND, kemik klempri	707
LANE-TREHOWAN, kemik elevatörü	635	LUC, ronjurlar	733, 734
LANG-STEVENSON, bağırsak klempri	446	LUCAE, bayonet pense/ler	112
LANGE, ekartör	330	LUCAS, gujlar	658
LANGE-HOHMANN, kemik elevatörleri	642	kemik küretler	677
LANGENBECK, ekartörler	344, 346	keskiler	658
elevatörler	634, 635	LUER, ekartör	335
kanat bıçak	18, 830	hemoroid pensler	473
kemik tutma pensi	700	kemik ronjurları	709, 711
metakarpal testeresi	832	LUER-FRIEDMANN, kemik ronjuru	709
raspalar	597, 625	LUER-KÖRTE, safra taşı kaşıkları	479
rezeksiyon bıçakları	19, 830	LUER-STILLE, kemik ronjurları	715, 716
LANGENBECK-GREEN, ekartörler	329	Lumbar mikro disektomi küretleri	685
Laringel aynalar	1, 6, 58		
LATHBURY-FARRELL, pamuk aplikatörleri	302-304	M	
LAWRENCE, diseksiyon ve dikiş pensi	243	MAC DONALD, disektör	616
portegü	170	MAGILL, aspiratör uçları	312
LAZAR, mikro sütür bağlama pensleri	99	dil pensi	8
LEBSCHKE, sternum keski	606	MAIER, spanç ve pansuman pensleri	136
tel testere için kondüktör	832	MAINGOT, histerektomi ve hemostatik pensler	249
LEECH-WILKINSON, biyopsi pens	554	MALTZ, kemik törpüsü ve raspası	690
uterin kanüller	562	Mamaria ekartör	588
LEES, ATROMATİK bronş klempri	281	MANNERFELT, ekartör, üçgen saplı	327, 328
LEGUEU, mesane spatula	495, 430	guj	658
LEITZ, ATROMATİK anastomoz klemp	291	osteotomlar	658
LEKSELL, kemik ronjurları	714	raspalar	622
LEKSELL-STILLE, kemik ronjuru	715	MARQUARD, kemik ronjuru	713
LELAND-JONES, ATROMATİK periferik damar klempri	270	MARTIN, ekartör	360, 521
LEMBERT, kemik ronjuru	708	pelvimetre	564
aspiratör uçları	307	MARTINI, kemik küretleri	676
kemik küretleri	680	MASING, ekartör	330
kemik ronjurları	710	HARDTIPS portegü	176
raspalar	621	kıkırdak kesme bıçağı	16
LERICHE, ekartörler	375	osteotomlar	659
hassas hemostatik pensler	220	MASSON, HARDTIPS portegü	184
LEWIN, kemik klempri	698	porgetü	173
LEWIS, kemik törpüsü ve raspalar	690	MASSON-LUETHY, portegü	173
LEWKOWITZ, plasenta ve ovum pensleri	575	MATHEU, yabancı cisim pensi	502
LEXER, diseksiyon makaslar	55	ekartör	339
HARDTIPS diseksiyon makası	82	HARDTIPS portegüler	190
HARDTIPS diseksiyon makası, Gripcut	89	portegüler	175
gujlar	663, 664	rektal spekulum	463
osteotomlar	663	vajinal spekulumlar	518
LEXER-MINI, gujlar	663	MATHIEU-STILLE, portegüler	175
osteotomlar	663	Matkap kılavuzları	817
LICHTENBERG, HARDTIPS portegü	190	Matkap kolları	817
LINDEMANN, el testeresi	825	Matkap T kol	817
LISTER, bandaj ve kumaş makasları	74, 75	MAYFIELD, kafa dayanakları	777
burun pensleri	134	kafa dayanağı uzatma çubukları	777
LISTON, ampütasyon bıçağı	18, 830	kafa klempri	776
kemik kesme pensleri	718, 720	kemik ronjuru	713
LISTON-KEY-HORSLEY, kemik kesme pensi	610, 721	masa bağlantı aparatları	776
LISTON-STILLE, kemik kesme pensi	610, 721	MAYNIHAN, bağırsak klempri	445
LITTLER, diseksiyon makası	46	safra taşı sondası	478
LITTLEWOOD, uterin tenekulum pensi	538		

MAYO , alet askıları	159	MILLS , kardiyovasküler makası	68, 477
cerrahi ve diseksiyon makasları	56	MINI-FINOCHIETTO , torasik ekartör	591
diseksiyon makasları	53, 55, 82	MISKIMON , otomatik laminektomi ekartör	403
HARDTIPS diseksiyon makasları	81, 82	MITCHELLS , raspa	626
HARDTIPS diseksiyon makası, Gripcut	89	MIXTER , diseksiyon ve dikiş pensleri	243, 245, 475
safra kanalı sondası	478, 530	MIXTER-O'SHAUGHNESSY , diseksiyon ve dikiş pensi	240
Supercut diseksiyon makasları,	93	Mikro damar makasları	66
MAYO-ADAMS , otomatik ekartör	400	Mikro disektörler	596, 761, 762
MAYO-HARRINGTON , diseksiyon makasları	55	Mikro halka penset	101
MAYO-HEGAR , HARDTIPS portegüler	180	Mikro huklar	762
portegüler	171, 172	Mikro kepçeler	762
MAYO-LEXER , diseksiyon makasları	54	Mikro ligatür makası	31
HARDCOATED diseksiyon makasları	94	Mikro makaslar	28, 30-32, 98, 101, 838, 844
HARDCOATED diseksiyon makasları, Gripcut	95	Mikro pensetler, titanyum	128
HARDTIPS diseksiyon makası	81, 82	Mikro portegüler	162, 163
HARDTIPS diseksiyon makası, Gripcut	89	Mikro raspa	762
MAYO-NOBLE , diseksiyon makasları	54	Mikro sütür bağlama pensetleri	99, 101
MAYO-ROBSON , bağırsak klempleri	444	Mikroskobik iğneler	845
MAYO-STILLE , cerrahi ve diseksiyon makaslar	56	Mini oyucu	815
diseksiyon makaslar	53	Mini vida tutucu	815
MC CLINTOCK , plasenta ve ovum pensi	574	MOLLISON , otomatik ekartörler	397, 400
MC CLURE , mikro makas	28	MOLT , raspa	620
MC GIVNEY , hemoroid pensi	470	MORE , protez çıkartıcı	821
MC INDOE , doku penseti	119	MORRIS , ATROMATİK sigmoid anastomoz pensi	273, 454
dura ve cilt hukları	324	ekartörler	356
hassas diseksiyon penseti	105	sternum ayırıcılar	586
kemik kesme pensi	719	MOYNIHAN , hassas hemostatik pens	219
MC KENTY , raspa	620	hemostatik pensler	232, 475
MC KENZIE , klip aplikatörleri	752, 753	MUHLING , kemik makası	77
perforatör	747	MUNCHEN , biyopsi küret	550
MC KISSOCK , raspa	625	MURPHY , ekartörler	344
MEAD , çekiç	671	MURPHY-LANE , luksasyon elevatörü	647
çekiç, yedek disk	671	MUSEUX , organ ve doku pensi	151, 539
kemik ronjuru	709	uterin tenekulum pensleri	537, 538
raspa	620	MÜHLING , raspalar	623
MEHDORN , damar klipsleri	208, 210	MÜLLER , aproksimatörler	209
Meme markörleri	7	ATROMATİK rektal anastomoz klemp	456
Menisküs pensi	818	ATROMATİK damar klipsleri	213
MERBURG MODELL , tel bükücü	803	damar klipsleri, travmatik olmayan	212
Metal kataterler	503	ekartörler	385, 497
METZAMBAUM , elektrocerrahi makasları	855	HARDTIPS portegü	185, 459
diseksiyon makasları	35, 50, 52	ince yara ekartörleri	322
HARDCOATED diseksiyon makaslar	94	ligatür pensi	212
HARDCOATED diseksiyon makası, Gripcut	95	mikro makaslar	33
HARDTIPS diseksiyon makaslar	85-87	mikro pensetler	100
HARDTIPS diseksiyon makasları, Gripcut	90, 91	mikro portegüler	162
Supercut diseksiyon makasları,	92	rektal makas	59, 458
METZENBAUM-NELSON , HARDTIPS diseksiyon makası	87		
MEYER , pozisyon pensleri	697	N	
MEYERDING , ekartörler	332, 357	NABATOFF , varis aletleri	599
otomatik ekartörler	406	NAGELE , doğum pensi	568
otomatik laminektomi ekartörler	407	NAUNTON MORGAN , HARDTIPS portegü	185
MICHEL , klip uygulayıcı penset	204	spekulumlar	466
klip uygulayıcı, çıkarıcı pensetler	204	NEGUS , aspiratör disektör	311
rinoskopik aynalar	6	hemostatik pensler	234
MICRO-ADSON , hassas diseksiyon pensetler	102, 128	NELATON , sonda	300
hassas doku penseti, Titanyum	129	NELSON , akciğer tutma penseti	122
hassas pensetler	114	NELSON-METZENBAUM , diseksiyon makasları	52
MICRO-ADSON , BEIMER, hassas penset	114	HARDTIPS diseksiyon makasları	86
MICRO-HALSTED , hassas hemostatik pensler	218	HARDTIPS diseksiyon makasları, Gripcut	91
MIDDELDORPF , ekartörler	352	NELSON-METZENBAUM(MC INDOE) , HARDTIPS diseksiyon makasları	86
MIKRO-ADSON , diseksiyon ve dikiş pensleri	235	NICOLA , küretler	785
MIKULICZ , batin ekartörler	378, 379, 387	raspa	782
hemostatik pens	234	NIEDERDELLMANN , osteotomlar	662
periton pensleri	246	NISSEN , diseksiyon ve dikiş pensi	244, 475
periton ve histerektomi pensleri	247	hassas hemostatik pens	222
MILLER , kemik törpüsü ve raspaları	691	NOON , ATROMATİK buldog klemp	262
MILLESİ , mikro makaslar	30	NORFLOK AND NORWICH , otomatik laminektomi ekartörler	403
MILLIGAN , raspa	617	NORTHBENT , ligatür makası	78
MILLIN , ligatür tutucu pens	192, 496	NORTHFIELD , kemik ronjuru	712
mesane ayırıcı	495	NOTO , organ ve doku tutma pensi	142, 542
mesane ekartörleri	494, 430	NOVAK , SCHOECKAERT, biyopsi küret	550

NOYES, göz makası	29	raspa	621
NUSSBAUM, bağırsak klempleri	445	ronjur	736
O		sonda disektör	614
O'CONNELL, disektör	617	PERCY, amputasyon ekartörleri	834
O'SHAUGHNESSY, diseksiyon ve dikiş pensleri	239	Perforatör	747
diseksiyon ve dikiş pensi	240	Periyost bıçak	19, 830
O'SULLIVAN-O'CONNOER, batin ekartörler	426	PERKINS, otomatik ekartörler	398
Obstetrik levye	569	PERWITZSCHKY, hassas makas	39
OBWEGESER, ekartörler	347	PHANEUF, periton ve histerektomi pensleri	248
ligatür iğneleri	810	PICCOLO, pamuk aplikatörleri	304
osteotom	662	PIERCE, raspa	619
OCHSNER, ATROMATİK aort klemp	277	trokar	316
ligatür penseti	107	PIPER, doğum pensi	569
safra kanalı sondası	478	PITHA, yabancı cisim pensi	154, 502
OFFICER, doku penseti	121	Plak tutucu pens	814
OLDBERG, ronjur	740	Plasenta ve ovum pensi	574
OLIVECRONA, beyin kaşıkları	750	PLESTER, aspiratör uçları	306
kemik ronjuru	712	otomatik ekartörler	399, 400
trigeminal bıçak	17	POIRIER, doku tutucu	146
OLLIER, ekartör	343	POOL, aspiratör kanülleri	313
OMBREDANNE, çekiç	672	Popliteal ekartörler	430
Organ ve doku tutma pensi	152, 541, 656, 822	Poş açıcı	565
Otomatik ekartörler	394, 395, 413-417, 790	POTTS, diseksiyon makası	49
Otomatik ekartörler, Titanyum	416	POTTS-DE MARTEL, kardiyovasküler makaslar	67, 68, 477
Otomatik ekartör, Titanyum bleydler	417, 790, 791	POTTS-SMITH, damar cerrahi makası	71
Otomatik laminektomi ekartörler	407	kardiyovasküler makaslar	68
Otopsi bıçağı	831	Pozisyon pensleri	696-698, 700
OVERHOLT, diseksiyon ve dikiş pensler	237	POZZI, organ ve doku tutma pensi	153, 535
OVERHOLT-GIESSENDOERFER, diseksiyon ve dikiş pensleri	236, 238	uterin tenekulum pensi	534
OVERHOLT-MIXTER, diseksiyon ve dikiş pensi	236	PRATT, organ ve doku tutma pensi	152, 541
Oyucular	811, 823	rektal spekulum	463
Oyucu ve delici	811	uterin dilatörler	526
Ö		PROB, kılavuz sondası	201
Ölçü skalalı taslar	864	Prostat ekartörü	377, 497
P		Protez çıkartıcılar	821
Pamuk aplikatörleri	303	Protez itici	821
Pansuman pensleri	1, 9, 38	PROVIDENCE, hassas hemostatik pensler	219
PAPAVERO, bayonet keski	779	PUTTI, kemik törpüsü ve raspaları	693
PAPAVERO-CASPAR, hipofizektomi spekulumları	778	Q	
PAPAVERO-HARTMANN, spekulum	778	QUERVAIN, elevatör	634
PARKER, ekartörler	336	QUINBY, hassas makas	39
PARKER-KERR, anastomoz pensi	451	R	
PARKS, anastomoz bleyd	467	R.N.O.H, kemik biyopsi trapanı	812
rektal bleydler	467	RAABE, aspiratör uçları	309
rektal ekartör	467	RAGNELL, diseksiyon makasları	35
sfinker bleyd	467	ekartör	335
Parmak yüzük testeresi	824	RAMPLEY, tampon ve pansuman pensleri	140
Parmak yüzük testeresi, yedek bleyd	824	RAMSEY, diseksiyon penseti	107
PARRY-COOLEY, ATROMATİK anastomoz klemp	291	doku pensetleri	121
PARTSCH, gujlar	657	RANDALL, biyopsi küret	550
keskiler	656	böbrek taşı pensleri	492, 493
raspalar	620	RANEY, klip aplikatörü	752
PASSOW, iticiler	669	RANKIN, hassas hemostatik pensler	221
PAUL, ekartör	333	Raspalar	615, 621, 623, 630, 631, 633, 761
PAULSEN, raspalar	622	RAY, küretler	784
PAYR, bağırsak klempleri	447	RECAMIER, plasenta ve ovum küretleri	559
kılavuz sondaları	202	uterin kaşıkları	557
pilor klemp	447	REDON, kılavuz iğneleri	317
PEAN, ATROMATİK hemostatik pensler	260	REILL, mikro portegüler	163, 844
hemostatik pensler	226, 227, 229, 233, 486	pozisyon pensi	696
tüp klemp	11	tel makası, elmas kesici ağız	807, 815
PEDERSON, vajinal spekulumlar	510	tendon stripperler	826
PELKMANN, yabancı cisim pensleri	154, 482, 532	REIN-KUPKA, HARDTIPS portegüler	188
PENFIELD, disektörler	616	Rektal makas	458
raspa	615	Rektal spekulum	462
PENNINGTON, bağırsak tutma pensleri	150	REMINGTON-HOBB, elektrocerrahi aletleri	854
raspa	619	RESANO, kırıldak makası	57
PENNYBACKER, kemik ronjuru	712	ATROMATİK sigmoid anastomoz pensi	455
		REVERDIN, batin ve bağırsak malası	391
		sütür aleti, reverdin iğneleri	193

REYNOLDS, diseksiyon makasları	49	SCHNIDT, hemostatik pensler	234
REYNOLDS-JAMESON, vasküler makas	35	SCHOEMAKER, bağırsak klempi	446
RIBBON, batin ve bağırsak malaları	391	SCHOENBORN, yara ve damar ekartörü	331
RICHARD, batin ekartörleri	421	SCHRÖDER, kemik küretleri	556, 688
RICHARDSON, ekartörler	353, 354	organ ve doku tutma pensleri	151, 153, 535, 541
RICHARDSON-EASTMAN, ekartörler	354	uterin tenekulum pensleri	535, 540
RICHES, elektrocerrahi pensi	855	SCHUBERT, biyopsi pensleri	551
RICHTER, özel ekartör	408, 525	SCHUKNECHT, aspiratör uçları	308
panç	724	SCHULZ, biyoptom	604
RNTNE, otomatik ekartör	398	ekartörler	349
ROBERTS, hemostatik pensler	232, 233	SCHULZE, uterin kanüller	562
raspa	627	SCHUMACHER, biyopsi pensleri	551, 553, 555
ROBIN, çamaşır klempeleri	157	göbek kordonu makası	72, 566
ROBIN-MASSE, batin ekartörler	421	kemik elevatörü	643
ROCHARD, batin ekartörler	388, 389, 488	sternum makası	606
batin ekartör bağlantı tertibatı	388	SCHUMACHER-WAGNER, kemik elevatörü	643
ROCHESTER-CARMALT, hemostatik pensler	232	SCHWEDISCHES MODELL, diseksiyon pensetler	107
ROCHESTER-OCHSNER, hemostatik pensler	230, 232	SCOVILLE, otomatik ekartörler	411, 412
ROCHESTER-PEAN, hemostatik pensler	228	SCOVILLE-HAVERFIELD, otomatik ekartörler	412
ROEDER, çamaşır klempi	156	SCOVILLE-RICHTER, ekartörler	411
ROGGE, sterilize pensi	865	SCUDDER, mide klempi	446
ROLLET, cilt ekartörleri	322	SEBILEAU, elevatör	634
Ronjurlar	733, 742	SEDILLOT, raspalar	625
ROSE, ekartör	335	SEGOND, histerektomi hemostatik pensi	250
ROTUNDA, irrigasyon kanülü	563	SEGOND-LANDAU, histerektomi ve hemostatik pensi	250
ROUX, ekartörler	336-338	SEIDL, vajinal spekulumlar	512
ROWBOTHAM, aspiratör ucu	312	SEIDLDBP, biyopsi pensleri	551
RÖTTGEN-RUSKIN, kemik ronjuru	713	SEIFFERT, sonda	302
RUBIN, kemik törpüsü ve raspaları	690	Sekestrum pensi	698
RUDD, hemoroid ligatürü	470	SELDIN, raspalar	627
RUMEL, diseksiyon ve dikiş pensleri	241	SELLORS, göğüs ekartörü	608
RUMEL-BELMONT, turnikeler	602	SELMAN, doku penseti	121
RUSKIN, kemik ronjuru	713	SEMB, kemik ronjuru	611, 716
RUSKIN-LISTON, kemik kesme pensler	719	kemik tutma pensleri	608, 699, 835
RUSS MODELL, doku pensetleri	121	raspalar	596, 597, 627
RUST, amputasyon testereleer	833	SEMKEN, doku pensetleri	116
amputasyon testere bleydleri	833	hassas diseksiyon pensetler	103
amputasyon testere sapı	833	SEMM, batin ekartörler	428
RYDER, DIAMOTE mikro portegüler	165, 166	vajinal spekulumlar	511
HARDTIPS portegüler	186, 187	SENN-MILLER, ekartör	332
		Serklaj telleri	801
S		Servikal mikro disektomi küretler	684
SAALFELD, komedon ekstraktör	840	SEWALL, raspa	615
SACHS, raspa	615	SEYFFERT, vajinal spekulumlar	511
SAENGER, plasenta ve ovum pensleri	573	SIEBOLD, rahim makası	61
Safra dilatörleri	481	SILVER, cilt nakil bıçağı	20, 841
SAMI, tümör doku bıçakları	765, 766	SIMON, ekartörler	330, 360, 521
SAROT, HARDTIPS portegüler	178	kemik küretler	556, 683, 688
hassas hemostatik pensler	224	SIMPSON, doğum pensi	568
hemostatik pens	233	uterin sonda	530
SATINSKY, ATROMATİK buldog klemp	287	SIMPSON-BRAUN, doğum pensleri	568
damar cerrahi makası	71	SIMS, HARDTIPS rahim makasları	83
SAUER, otomatik ekartör	394	HARDTIPS rahim makasları, Gripcut	90
SAUERBRUCH, ciğer spatulası	364	jinekoloji makasları	63, 65
ekartörler	348	rektal spekulumlar	462-464
göğüs makasları	609	uterin kaşıkları	558
tutma pensi	11	uterin sondalar	530
SAUERBRUCH-CORYLLOS, kemik ronjurlar	611, 717	vajinal spekulumlar	516
SAUNDERS, biyopsi küret	550	SIMS SIEBOLD, rahim makası	58, 64
SCHADEL, çamaşır klempeleri	155	Sınırlayıcı kaliplar	527
SCHAMBERG, küret	840	Silikon bölücü	527
SCHEDE, kemik küretleri	678	Sinir ve sinir kökü ekartörü	334
SCHERBACK, vajinal spekulumlar	524	Sinovektomi ronjuru	708
SCHINDLER, histerektomi hemostatik pensi	251	SMELLIE, plasenta ve ovum pensi	575
SCHINIC, dermatomlar	20, 841	SMILLE, ekartörler	350, 819
SCHMID, ağız açıcı	3	menisküs bıçakları	818
damar temizleme kanülleri	603	SMITH-BUIE, rektal ekartör	467
disektörler	596	SMITH-PETERSEN, gujlar	661
SCHMIEDEN, kılavuz sondası	201	osteotomlar	661
SCHMIEDEN-TAYLOR, dura makas	69	Soğuk ışık taşıyıcı	467
SCHNEIDER, raspa	625	Soğuk ışık taşıyıcı ve bleyd	467
SCHNEIDER-SAUERBRUCH, raspa	625	SOMER, uterin çıkartma pensi	544

Sonda	300-302, 472, 827, 834	Tel kesme pensleri, Elmas Kesici Ağız	805, 807
SPACKMAN, vulsulum kanülü	563	Tel kılavuzlar	800
Spanç pansuman pensi	134	Tel makası	806
Spanç pensleri	1, 9, 38	Tel makasları, Elmas Kesici Ağız	806, 807
Spanç ve pansuman pensler	134, 137	Tel tabanlar	528
Spatula	304	Tel tutma pensleri	803, 804, 815
SPENCER, ligatür makaslar	78	Tel tutma pensi, Elmas Kesici ağız	802
SPENCER-WELLS, hemostatik pensler	227	Tel ve vida kesme makasları	809
SPURLING, ronjurlar	735, 736, 739	Tendon geçmeli pensler	144, 825
ST.BARTS, sinir ve damar huku	320	Tendon stripperler	826, 827
ST.MARKS, pelvis ekartörler	384, 461	Testis sabitleme klemp	500
ST.MARKS-GIRONA, perianal ekartör	467	THOMS-GAYLOR, biyopsi pensleri	551
ST.MARTIN, hassas göz penseti	114	THOREK, damar cerrahi makası	71
STAMM, kemik kesme pensi	718	THORPE, korneal penset	102
STELLBRINK, sinovektomi ronjurlar	708	Tırnak çıkarma pensleri	824
STELZNER, rektal makaslar	58, 457	Tırnak kesiciler	5
Steril konteynerler	528	Tırnak makasları	1, 4, 5, 78
Sterilize pensler	865	Tırnak törpüsü	5
STERNBERG, ekartörler	339	TISCHLER, biyopsi pensi	555
Sternum ekartörler	588	Tiroid ekartörü	409
STEVENS, damar ve tendon makaslar	48	Torasik ekartörler	588, 590
diseksiyon makaslar	34	Tornavidalar	414, 778, 790, 814
hassas diseksiyon makası	48	Tornavida T kollar	817
STIEGLITZ, kıymık pensetler	123, 839	TÖNNIS, diseksiyon makaslar	51
STILLE, alçı makasları	796	disektörler	596, 618
böbrek klempieri	488	dura ekartör	323
diseksiyon makasları	54	HARDTIPS portegü	189
gujlar	660	oluklu disektör	618
kemik ronjuru	714	portegü	175
keskiler	660	TÖNNIS-ADSON, diseksiyon makaslar	50
osteotomlar	660, 835	HARDTIPS diseksiyon makası	87
STILLE-BARRAYA, damar ve tümör pensetler	120	HARDTIPS diseksiyon makası, Gripcut	90
STILLE-RUSKIN, kemik ronjuru	715	TÖNNIS MODIF., HARDTIPS portegü	189
STOCKMANN, penis pens	501	Traksiyon aletleri	746, 798, 799
STRANDELL-STILLE, ekartörler	329	Traksiyon aleti, matkap uçları	746
STRASSBURGER, doku pensetler	118	Traksiyon aleti, sabitleme diskleri	799
STRATTE, HARDTIPS portegüler	183	Traksiyon aleti, tornavida	798
STRAUSS, penis pens	501	Traksiyon anahtarı	799
STRUCK, göğüs ekartörleri	580	Traksiyon kancaları	799
STRULLY, damar makası	69, 477	TRAVERS, laminektomi ekartör	401
dura makas	69	TRELAT, raspa	621
SUBRAMANIAN, ATROMATİK aort klemp	278	vajinal spekulum	508
SUETIN, bandaj makası	76, 794	TRELAT, vajinal spekulumlar	508
Supercut diseksiyon makasları	92	TREVES, doku pensetler	118
Sütür aleti, ligatür iğneleri	198, 810	Trigeminal bıçak	17
Sütür pensetler	121, 125	TROELTSCH, açılı pensetler	113
SWEDISH, disektörler	614	Trokarlar	313, 316
SWEET, kemik pançları	748	TROTTER, kemik ronjuru	712
SYME, raspa	616	TROUSSEAU, tiroid dilatör	409
sütür aleti, ligatür iğnesi	198	TUDOR-EDWARDS, batin ekartör	381
SYPERT, iticiler	669	TUFFIER, arter tutma pensi	146
kemik küretleri	687	batin ekartör	381
kemik ronjuru	717	batin ve bağırsak malası	390
panç	724	göğüs ekartörleri	581
ronjur	742	TURANTAN, otomatik ekartörler	410
SYSTRUNK, cerrahi makas	45, 825	TURNER WARWICK, gerici buji	505
		batin ekartörler	427, 428
T		Tumikeler	602
TAGER, kemik elevatörü	647	TUTTLE, akciğer tutma penseti	122
Tahta ağız açıcı	3	TÜBINGER, ekartör	360, 521
TARNIER, doğum pensi	570	otomatik ekartör	400
Taşlar, yuvarlak	864	safra taşı pensi	483
TAYLOR, ekartörler	410, 648	Tüp klempier	10, 11
otomatik ekartörler	412		
TEALE, uterin tenekulum pensler	538, 540	U	
Tel bükme pensi	804	UCHIDA, radikal histerektomi aletleri	547, 548
Tel bükücüler	803	UFFENORDE, kemik küreti	683
Tel çıkarıcılar	804	ULRICH, fistül bıçağı	16
Tel çıkarma pensleri	803	spanç ve pansuman pensi	137
Tel gerici	799	Ummikro disektomi küreti	685
Tel kesme makası	79, 805	UNNA, küret	840
Tel kesme pensleri	806, 808	US. ARMY, ekartör	339

Üterin sondalar 502, 530
Üterin tenekulum pensu 536

Ü

Üreter pensu 500
Üretral ekartör 377

V

Vajinal spekulümlar 517
Vakum küretleri 315, 561
Valf ekartörler 589
VALLEIX, uterin sonda 531
VANNAS, mikro makas 28-30, 844
VARADY, varis aletleri 599
Venoz plexus pensu 498
VERBRUGGE, kemik tutma pensleri 705
VERBRUGGE-MÜLLER, kemik elevatörleri 641
VERHOEVEN, aspiratör uçları 306
VIDAL, lupus kazıyıcı 840
VISE, mikro sütür bağlama pensetleri 99
Vida çıkarma pensu 817
Vida çıkartıcı T kol 817
VOLKMANN, ekartörler 340, 341
kemik ekartörleri 341
kemik küretleri 676, 679

W

WACHTEL, DIAMOTE mikro diseksiyon penseti 127
DIAMOTE mikro doku penseti 127
HARDTIPS mikro portegü 164
WAGENER, sinir ve damar hukları 320
WAGNER, çekik 671
çekik diski, metal 671
çekik diski, plastik 671
gujlar 666
kemik elevatörü 635, 637
raspalar 633
ronjurlar 742, 743
tel uzatma 810
WALLICH, plasenta ve ovum küreti 560
WALTER, gujlar 660
osteotomlar 659
WALTON, biyopsi pensu 469
WANGENSTEEN, HARDTIPS diseksiyon pensetleri 125
HARDTIPS portegü 184
portegü 173
WARD, raspa 620
WATSON cilt nakil bıçağı 20, 841
WATSON-CHEYNE, raspalar 616
WATSON-JONES, kemik elevatörü 638
WAUGH, hassas doku pensetleri 120
WEBER, ATROMATİK aort anastomoz klemler 279
WEBSTER, HARDTIPS portegü 176
portegü 170
WECKER, iridektomi makası 29
WEIL-BLAKESLEY, ronjurlar 735
WEISSBARTH, vajinal spekulümlar 523
WEITLANER, otomatik ekartörler 396, 397, 401, 402, 845
WELLER, diseksiyon makası 57
menisküs pensu 818
WERTHEIM, ATROMATİK histerektomi pensleri 252
HARDTIPS diseksiyon makasları 83
HARDTIPS portegüler 183
histerektomi hemostatik pensler 249, 250
histerektomi pensler 254, 489
jinekoloji makasları 65
kompresyon pensu 256, 490
WERTHEIM-CULLEN, kompres pensu 490
WIENER MODELL, periton histerektomi pensleri 248
WIKSTROEM, diseksiyon ve dikik pensu 240
WILDE, açılı penset 113

WILLETT, kafa derisi tutucu pensu 571
WILLIAMS, organ pensu 141
WILLIGER, ekartörler 332
kemik küretleri 679
raspalar 620
elevatörler 634
WILSON, hemostatik pensu 234
organ ve doku tutma pensu 153, 534
WILSON, HEY, elektrocerrahi pensu 855
WINKELMANN, sünnat klemleri 501
WINTER, plasenta ve ovum pensleri 572
WITT, sternal delme iğneleri 606
WOLFF, alçı kırıcılar 797
küretler 840
WOODSON, raspa 617
WÖRRLEIN, pozisyon tamperi 698
WRIGLEY, doğum pensu 569
WULLSTEIN, aspiratör uçları 307, 308
otomatik ekartörler 398

Y

Yabancı cisim pensu 154
YANKAUER, aspiratör kanülü 314, 607
aspiratör ucu 314
Yara ve damar ekartörleri 331, 333
Yara ve soluk borusu ekartörü 325, 326, 500
YASARGIL, aspiratör uçları 312
disektörler 759
hareketli mikro ayna 758
kanül 311
klip aplikatörleri 768
klip aplikatörleri, titanyum 769
mikro damar bıçakları 764
mikro disektörler 763
mikro kaşık küret 763
mikro makas 30
mikro portegü 162
mikro raspalar 763
ronjurlar 740
tümör, doku tutma pensetleri 110, 111
yaylı huklar 753
LEYLA ekartörler 770
LEYLA ekartör bağlantı başlığı 771
LEYLA ekartör, esnek kol 770
LEYLA ekartör, masa bağlantı elemanları 771
LEYLA ekartör, tespit elemanları 770
Yaylı huklar 753, 774
Yedek bıçak 20, 841
YEOMAN, biyopsi pensu 468
YOUNG, prostat ekartörü 497
YOUNG, HRYNTSCHAK, bumerang portegü 192, 499

Z

ZENKER, diseksiyon ve dikik pensleri 242
ekartörler 361
ZIELKE, gujlar 664
Zincir ağırlık 821
Zincirli huk 774
ZOELLNER, aspiratör uçları 306, 308
ZUFAL-JANSEN, kemik ronjuru 713
ZWEIFEL, HARDTIPS portegüler 191

A		
ABBEY, mucosa needle	863	
Abdominal and intestinal spatulas	390, 750	
Abdominal retractors	420-422	
Abdominal retractor (chain and weight)	388	
Abdominal retractor, weight	388, 524	
Abdominal retractor, with chain	388	
Abdominal scissors	62	
ABEL, uterine tenaculum forceps	536	
ABRAHAM, tonsil knife	17	
ADAIR, uterine tenaculum forceps	534	
ADLERKREUTZ, vascular and tumor forceps	120	
ADSON, bone punch	748	
bone rongeur	712	
delicate dissecting forceps	102	
delicate forceps	114, 838	
delicate hemostatic forceps	222	
delicate tissue forceps	115	
delicate tissue forceps, Titanium	129	
electrosurgical instruments	854	
forceps, bayonet, shaped	112	
HARDTIPS dissecting forceps	124	
needle holder	172	
nerve and vessel hooks	320	
perforator	747	
raspatories	621, 624	
self, retaining laminectomy retractors	403, 405	
self, retaining retractors	399	
suction tubes	306	
tissue forceps	114	
ADSON-BABY, self, retaining retractors	399	
ADSON-BROWN, tissue forceps	115	
ALEXANDER, bone rongeur	710	
gouges	657	
raspatory	597, 626	
Alignment key	768	
ALLEN, intestinal clamp	438	
osteophyte chisel and scraper	621	
Allen T arm	817	
ALLENBERG, ATRAUMATIC hemostatic forceps	276	
bulldog clamp	605	
forceps	431	
iliaca retractors	431	
self, retaining retractor	401	
ALLIS, artery traction forceps	146	
ATRAUMATIC organ forceps	147, 459	
organ and tissue grasping forceps	147, 148	
tissue grasping forceps	147	
ALLIS-THOMS, organ tissue grasping forcep	148	
ALLISON, lung spatulas	363	
ALLPORT, self, retaining retractor	395	
ALM, self, retaining retractor	395	
Amputation knife	831	
Amputation saw	832	
Amputation saw blade	832	
Anahtar	812, 813	
ANGEL, wire cutting forceps	805	
Antrum punch	778	
Aorta punches	604	
Approximator	211, 845	
ASCH, secretion scoop	502, 550	
ASSMUS, probe	755, 826	
ATRAUMATIC, organ and tissue grasping forceps	143, 473, 543	
bronchus forceps	284, 452	
bulldog clamps	216	
coarctation clamps	295	
hemostatic forceps	260	
ultra, light forceps	108	
Attachment node	204	
AUFRIEHT, bone file and rasps	690	
AUSTIN, micro suture tying forceps	99	
Autopsy knife	831	
AUVARD, vaginal speculas		523
B		
BABCOCK, organ and tissue grasping forceps	148, 149	
BABY CRILE WOOD, HARDTIPS needle holder	177	
Baby nail scissors	1, 4, 78	
BABY-ADSON, dissecting and ligature forceps	235	
BABY-ALLIS, tissue grasping forceps	146	
BABY-COLLIN, abdominal retractors	420	
BABY-CRILE, delicate hemostatic forceps	219	
BABY-KOCHER, intestinal clamps	439	
BABY-METZENBAUM, dissecting scissors	50	
HARDCOATED dissecting scissors	94	
HARDTIPS dissecting scissors	85	
HARDTIPS dissecting scissors, Gripcut	90	
Supercut dissecting scissors	92	
BABY-MIKULICZ, peritoneum forceps	246	
BABY-MIXTER, dissecting and ligature forceps	235	
BABY-OVERHOLT, dissecting and ligature forceps	235	
BABY-ROUX, retractor	336	
BABY-SENN-MILLER, retractors	332	
BACKHAUS, towel clamps	156	
BACKHAUS-KOCHER, towel clamp	156	
BAILEY, rib spreaders	608	
BAINBRIDGE, intestinal clamps	438	
BAKES, dilators	480	
BALFOUR, abdominal retractors	424, 425	
BALFOUR, BABY, abdominal retractor	423	
BALLANTINE, self, retaining retractor	410	
BANE-HARTMANN, bone rongeur	711	
BARNES-NEVILLE, obstetrical forceps	570	
BARPE, vascular and neurosurgery scissors	70, 498	
BARRAQUER, micro needle holders	163	
self, retaining retractor	394	
BARRE, bipolar forceps	499	
dissecting and ligature forceps	241, 498	
scalpel handles	22	
BARRON, hemorrhoidal ligator	470	
hemorrhoidal ligator conic loader	470	
hemorrhoidal ligator handle	470	
hemorrhoidal ligator shaft	470	
suction tubes	308	
BARSKY, fine wound retractor	324	
BART, bone curette	676	
BAUMGARTNER, HARDTIPS needle holder	177	
HARDTIPS wire twisters	182, 802	
needle holder	170	
Bayonet, shaped forceps	112	
BEACHAM, amniotome	565	
BECK, rongeur	736	
BECKMANN-ADSON, self, reta laminectomy retractors	404, 405	
BECKMANN-EATON, self, retaining laminectomy retractor	405	
BEEBE, wire cutting scissors	79	
BEHRMAN, uterine cannulas	562, 563	
BELLUCCI, suction tubes	308	
Bending irons	816	
BENGOLEA, delicate hemostatic forceps	224	
BENNETT, special bone levers	645	
BENSAUDE, anoscopes	465	
BENSON, stomach clamp	450	
BERGER, biopsy forceps	553	
BERGMANN, mallets	672, 673, 835	
plaster cutting scissors	75, 794	
scalpels	14	
wound and trached retractor	325	
BERKELEY-BONNEY, hysterectomy hemostatic forceps	251	
BERLIN, biopsy curette	550	
BERNHARD, uterine tenaculum forceps	156, 534	
BERRY, HARDTIPS wire twisters	182, 802	
BETHUNE, rib shears	609	
BEYER, bone rongeurs	711, 713	
BIEMER, applying forceps for vessel clips	210	

approximators	211, 845	ligature needles	200, 810
micro vessel clips	208	retractors	365, 367, 368, 386
nerve and vessel hook	754	rib shear	609
vessel clips	210, 847	sigmoid anastomosis forceps	452
BIEMER-MÜLLER , approximators	209, 845	suture instruments ligature needle	199
BIER , amputation saw	833	BRUNS , bone curettes	678, 682
amputation saw blades	833	plaster scissors	76, 795
amputation saw handle	833	BRÜNINGS , biopsy forceps cannulas	555
BIRCHER-GANSKE , meniscus forceps	818	rongeurs	733
BIRKETT , delicate hemostatic forceps	223	tongue depressors	2
BISHOP-HARMON , delicate eye forceps	114	BRYANT , sponge and dressing forceps	134
Biopsy forceps	468, 469, 554	BUCHWALD , tongue depressors	2
Biopsy forceps handle	468, 555	BUCK , cotton applicator	302
Blade ejector forceps	416	BUCK-GRAMCKO , bone levers	636
BLAKE , gall stone forceps	482, 602	BUELAU , trocars	316
uterine curette	560	Bulldog clamps	215, 605
Blood scoops	391, 831	BUMM , placenta and ovum curettes	559
BLOUNT , retractor	350, 819	uterine scoops	558
special bone lever	647	BUNNELL , hand drill	813
BLUMENTHAL , bone rongeurs	709	tendon strippers	827
BOER , placenta and ovum forceps	575	BUNT , safety pin	159
Bone biopsy trephines	812	BURKE , hysterectomy forceps	255, 549
Bone curettes	676, 677, 679, 680, 689	BUSHE , bone curettes	680
Bone cutting forceps	718, 719	BÜCHS , raspatory	624
Bone file and rasps	690, 691, 693	retractor	355
Bone holding forceps	700, 705, 706		
Bone levers	636-638, 640, 641, 644, 646	C	
Bone punch	748	CAIRNS , delicate hemostatic forceps	219, 220
Bone retractor	340	dura retractor	322
Bone rongeurs	708, 709	elevators	634
Bone shears	835	CAIRNS-DOTT , delicate dissecting forceps	105
Bone taps	814	Calipers	7
BONNER MODELL , micro suture tying forceps	99	CAMPBELL , nerve and nerve root retractor	334
BONNEY , dissecting forceps	107	Cannulas	315, 561
polypus and ovum forceps	545	CANNY-RYALL , retractors	338
tissue forceps	122	CARREL , delicate hemostatic forceps	218
BOROWSKI , aorta value retractors	595	CARTER , raspatory	616
BOSE , self, retaining retractor	394	Cartilage scissors	51
wound and trached retractors	325	CASPAR , attachment node	204, 755
Bowel and cartilage scissors	835	bone curettes	686, 687
Bowel scissors	59	dissector	615, 760
Bowl rounds	864	micro dissectors	760
Bowl with measuring scales	864	micro knives	767
BOWMAN , probes	302	nerve and nerve root retractors	334
BOZEMANN , uterine dressing forceps	532, 533	nerve and vessel hooks	321, 757
uterine scissors	61	raspatories	615, 623, 759
vaginal speculas	524	retractors	355, 414
vaginal specula, handles	524	rongeurs	738, 741, 743
BOZEMANN-DOUGLAS , uterine dressing forceps	533	scalpel handle	24
BÖHLER , bone cutting forceps	719	self, retaining retractors	413-415, 416
bone rongeurs	713	tampers	669
Braces	817	CASTANEDA , ATROMATIC anast and multi, purpose clamps	263, 264
BRAITHWAITE , skin graft knife,	21	CASTROVIEJO , delicate eye forceps	114
Brain shunts	748	eye scissors	29
Brain spatulas	750	HARDTIPS micro needle holders	164
BRAND , tendon seizing forceps	145	micro needle holders	162
BRAUN , organ and tissue grasping forceps	151, 539	Catheter guide	504
uterine depressor	531	CATLIN , amputation knife	18, 831
uterine tenaculum forceps	534	CAWTHORNE , cotton applicator	302
vaginal speculas	518	Cement extractors	823
BRAUN-STADLER , bandage scissors	73	Cement pushers	822
episiotomy scissors	73, 606, 567	Cerclage wires	801
BREISKY , vaginal speculas	516, 520	Cervical micro dissection curettes	684
BRIDGE , delicate hemostatic forceps	225	CHADWICK , delicate scissors	39
BRISTOW , bone level	635	Chain hook	774
BROCK , micro suture forceps	101	CHAMPIONNIERE , bone drill	811
BRODIE , probe	300, 472	CHANDLER , bone levers	628
BROM , nerve and vessel hook	320	CHAPUT , artery traction forceps	146
BROPHY , delicate dissecting forceps	104	CHARNLEY , tissue forceps	122
tissue forceps	118	CHARRIERE , amputation saws	832
BROWN , delicate tissue forceps	115	amputation saw blades	832, 833
BRUNNER , guiding probes	200	amputation saw handle	833

CHEATLE, sterilizing forceps	159, 865	suture instrument ligature needle	199
CHERON, sponge and dressing forceps	139	CORYLLOS, lung spatulas	364
Chisels	656, 662, 663, 665	COTTLE, chisel	657
CINELLI, osteotomes	659	chisel and osteotome	657
CITELLI, punches	722	dissecting scissors	46
Clamp holders	450	dura retractor	323
CLAUS VAN EICKEN, suture instruments ligatur needle	199	fine wound retractor	322
Clip applicators	768	forceps, bayonet, shaped	112
Clip applicators, Titanium	769	mallet	672, 779
Clip applicator forceps	578, 579, 752	nasal speculums	778
Cloth scissors	76	osteotomes	657, 779
CLOWARD, center pins	789	raspatories	619, 623
coutery hook	788	retractors	329, 330
depth gauge	789	COTTLE-KNAP, scissors plastic surgery	50
dowel cutters	789	COTTLE-MASING, scissors plastic surgery	47
dowel cutter shaft	789	Cotton applicators	303
dowel ejector	789	CRAFOORD, delicate hemostatic forceps	225
dowel handle	789	CRAFOORD MOD, delicate hemostatic forceps	225
dowel holders	789	CRAIG, rongeurs	732
drill guards	789	CRAIG-DOMNICK, rongeur	732
drill guard cap	789	CRILE, delicate hemostatic forceps	220, 221
drill shafts	789	needle holder	175
drill tips	789	nerve and vessel hook	320
elevators	788	retractor	335
guard guides	789	CRILE-MURRAY, needle holder	171
handle inside diameter	789	CRILE-WOOD, HARDTIPS needle holders	178
lamina spreaders	419, 787	needle holders	171
mallets	670, 788	CRUCHFIELD, skull traction instruments	746
osteotome	788	CUSCO, vaginal speculas	509, 510
retractors	418, 786, 788	CUSHING, delicate dissecting forceps	104, 838
retractor blades	418, 786	delicate dissecting forceps, Titanium	130
wrenches	789	HARDTIPS dissecting forceps	125
COBB, gouges	668	nerve and vessel hooks	320
raspatories	628, 629	perforators	747
COBBETT, skin graft knife	21	rongeurs	737, 739
COBRA, bone levers	645	tissue forceps	118
COCK, rectal specula	464	wound and vein retractors	331
Cold light carrier	467	CUSHING-KOCHER, wound and vein retractor	331
Cold light carrier and blade	467	CUSHING-LANDOLT, hypophysectomy speculums	779
COLLER, delicate hemostatic forceps	221	Cutting terminator, for biopsy forceps	468, 469, 555
COLLIN, abdominal retractors	420, 422	CZERNY, gall stone forceps	482
clip removing forceps	204	organ and tissue forceps	151, 540
intestinal grasping forceps	150	rectal specula	462
kidney elevating clamp	491, 545	retractor	339
organ and tissue grasping forceps	143		
retractor	335	D	
sponge and dressing forceps	139	DAHLGREN, dura protector	749
tongue forceps	1, 8, 41	hook	749
umbilical cord clamp	567	DANDY, delicate hemostatic forceps	220
uterine curette	560	DARDIK, ATRAUMATIC multi, purpose clamps	285
uterine elevating forceps	544, 545	DARLING, self, retaining laminectomy retractors	407
vaginal speculas	508	DARTIGUES, kidney elevating clamp	491, 544
COLLIN-HARTMANN, retractor	339	DAUBENSPECK, bone curettes	680
COLLIN-POZZI, uterine tenaculum forceps	534	DAVIDSON, scapula retractors	366
Comedone extractor	840	DAVIS, dissector	596, 614
CONE, laminectomy retractor	401	raspatory	614
CONVERSE, fine wound retractor	324	DE BAKEY, arteriotomy scissors	49
HARDTIPS needle holder	177	ATRAUMATIC anastomosis multi, purpose clamps	264
needle holder	170	ATRAUMATIC aorta anastomosis clamp	280
COOLEY, ATRAUMATIC anastomosis and multi, purpose clamps	264, 265, 292	ATRAUMATIC aorta aneurysm clamps	274-276
ATRAUMATIC anastomosis clamps	288, 290, 293	ATRAUMATIC aorta clamp	278
ATRAUMATIC aorta clamp	297	ATRAUMATIC bulldog clamps	217, 262
ATRAUMATIC bulldog clamps	286, 287	ATRAUMATIC coarctation clamps	271
ATRAUMATIC coarctation clamps	294	ATRAUMATIC dissecting ligature forceps	282
ATRAUMATIC forceps	108	ATRAUMATIC ductus clamps	269
ATRAUMATIC multi, purpose clamps	289, 296	ATRAUMATIC forceps	108, 109, 459
atrium retractors	592-594	ATRAUMATIC forceps, Titanium	131
delicate dissecting forceps	105	ATRAUMATIC micro forceps	108
sternum retractors	587	ATRAUMATIC multi purpose clamps	272
vascular and neurosurgery scissors	70	ATRAUMATIC peripheral vascular clamps	269, 270
COOLEY-BECK, ATRAUMATIC anastomosis clamps	288	ATRAUMATIC sigmoid anastomosis forceps	273, 454
COOPER, surgical scissors	42	ATRAUMATIC tangential occlusion clamps	268

ATRAUMATIC ultra, light forceps	131	needle holder	171
cardiovascular scissors	67, 68	probe	300
femur retractors	408	raspatories	598, 632
HARDTIPS needle holders	178, 179	towel clamps	155
HARDTIPS vascular scissors	84, 477	vaginal speculas	522
rib retractors	583, 585	Dressing forceps	1, 9, 38
sternum spreaders	586	Drill guides	817
suction cannulas	314, 607	Drill T arm	817
TITANIUM ultra light forceps	131	Drilling chucks	812
vascular dilators	600, 601	DUBOIS , uterine scissors	64
DE BAKEY-BAINBRIDGE , ATRAUMATIC hemostatic forceps	260	DUNHILL , delicate hemostatic forceps	218, 223
DE BAKEY-BECK , ATRAUMATIC vena cava clamps	267	DUPLAY , sponge and dressing forceps	135
DE BAKEY-HESS , bulldog clamps	214	uterine tenaculum forceps	536
DE BAKEY-KELLY , ATRAUMATIC, hemostatic forceps	260	Dura and skin retractor	324, 757
DE BAKEY-MC QUIGG-MIXTER , ATRAUMATIC bronchus clamp	281	Dura retractor	323, 757
DE BAKEY-MIXTER , ATRAUMATIC dissecting ligature forcep	283	DURHAM , retractor	352
DE, BAKEY-PEAN , ATRAUMATIC hemostatic forceps	261	DUVAL , intestinal grasping forceps	150
DE BAKEY-SATINSKY , ATRAUMATIC tangential occlusion clamps	268	intestinal forceps	122
DE LEE , pelvimeter	564	DUVAL-COLLIN , organ tissue grasping forceps	149
DE MARTEL , conductor	749		
DE MARTEL-WOLFSON , anastomosis clamps	450	E	
closing forceps	450	EAST GRINSTEAD (WARD) , chisels	658
DE VILBISS , dura protector	749	EAST GRINSTEAD , osteotomes	658
DEAVER , retractors	369-374	EASTMAN , chisels	658
surgical scissors	45	vaginal specula	518
Delicate dissecting forceps	103-105, 838	ECHLIN , bone rongeurs	714
Delicate dissecting forceps, Titanium	130	Electrodes	856-862
Delicate dissecting scissors	103	Electrode cables	863
Delicate scissors	1, 4, 34, 36-40	Electrode container	858, 859
DEMEL , wire guides	800	Electrode hol	863
twisting forceps	801	Electrode racks	858
DENIS-BROWNE , abdominal retractors	428	Electrosurgical instruments	848-855
intestinal forceps	122	Elevator	634
Depth gauges	814	EMMET , retractor	330
DERF , HARDTIPS needle holder	177	sponge and dressing forceps	139
needle holder	170	Enderarterectomy strippers	603
DERRA , ATRAUMATIC anastomosis and multi, purpose clamps	265	ENGEL , plaster saw	795
DERRA, COOLEY , ATRAUMATIC anastomosis clamp	289	ENGIL MOD , towel clamp	155
DESCHAMPS , suture instruments, ligature needles	194-197	Episiotomy scissors	73, 567
DESJARDINS , dissecting and ligature forceps	244, 476	EPPENDORE , biopsy forceps	553
gall duct probes	478	EPSTEIN , bone curettes	681
gall stone forceps	483	ESMARCH , plaster cutting scissors	75, 794
gallstone scoops	479	plaster knife	795
DESMARRES , retractors	330	Extraction pliers	804
DETRICH , cardiovascular scissors	67	Extraction pliers for wires	803
DIAMOTE micro forceps	125-127		
DIAMOTE micro forceps, Titanium	128	F	
DIAMOTE micro needle holders	165, 166, 168, 169	FAHLBUSCH , micro curette	783
DIAMOTE micro needle holders, Titanium	167	micro spoon	783
DICK , ATRAUMATIC anastomosis clamps	256, 284, 451	FARABEUF , bone holding forceps	701
ATRAUMATIC anastomosis forceps	451	raspatories	626
DIEFFENBACH , bulldog clamps	214	retractors	335
DIETRICH , ATRAUMATIC aorta clamp	277	FARABEUF-COLLIN , raspatories	626
bulldog clamps	215	FARABEUF-LAMBOTTE , bone holding forceps	701
DINGMANN , bone holding forceps	699	FARRELL , cotton applicators	303, 304
DITTEL , urethral dilating bougies	504	FAURE , biopsy forceps	551
DIXON-LOVELACE , delicate hemostatic forceps	222	peritoneum & hysterectomy forceps	247
Dilator	754	FAVOLORO , cardiovascular scissors	68
Dissecting and strabismus scissors	34	FEILCHENFELD , splinter forceps	123, 839
Dissecting forceps	106, 107, 834, 836	Femoral retractor	644
Dissecting and ligature forceps	235, 236	FERGUSON , bone holding forceps	700, 835
Dissecting forceps, Titanium	130	pressure clamps	474
Dissecting scissors	46	suction tubes	305
Dissectors	615	FERGUSON-ACKLAND , mouth gag	3
Distractors	698, 799	FERRIS-SMITH , HARDTIPS dissecting forceps	125
DOCKHORN , retractors	355	FICKLING , hemostatic forceps	232
DOUNAY , biopsy forceps	554	mallet	670
DOYEN , abdominal retractors	380, 382, 387, 388, 519	FINECHIETTO , dissecting and ligature forceps	244
hemorrhoidal forceps	474, 543	HARDTIPS needle holder	186
intestinal clamps	438-441	rib retractors	580-583
lateral speculums	522	thoracic retractors	591
myoma screws	546		

FINOCHIETTO-BURFORD, rib retractors	584	GLUCK, rib shear	609
FINSEN, self, retaining retractors	394, 395, 845	GOELET, retractor	337
FINSTERER, irrigation cannula	315, 607	GOLIGHER, abdominal retractor	426
FISCH, dura and skin hook	324, 757	GORNEY, dissecting scissors	51
Fiber light attachment for NAUNTON, MORGAN	466	suction dissector	311
Finger goniometer	7	Supercut dissecting scissors,	93
Finger ring saw	824	GOSLEE, Wire holding forceps	803, 815
Finger ring saw, replacement blade	824	GOSSET, abdominal retractors	423, 424
Fistula knives	16	Gouges	656, 664, 666-668, 817, 822
Fistula probe	472	GOURDET, bone curettes	556, 688
FOERSTER BALLANGER, sponge dressing forceps	140, 474	GRAEFE, delicate tissue forceps	115
FOMON, bone file and rasps	691	dissecting scissors	46
dissecting scissors	47	nerve and vessel hooks	320
osteotomes	659	skin retractors	322
retractor	329	GRAVE, vaginal speculas	510
Forceps	823	GRAY, dissecting and ligature forceps	244, 475
Foreign body forceps	154	GREEN-ARMYTAGE, caesarean hemostatic forceps	571
FORMBY, suction tube	307	GREENE, retractor	352
FOWLER, tonsil knife	17	GREGORY, ATRAUMATIC profunda clamps	282
FOX, curettes	840	GREY-TURNER, delicate hemostatic forceps	223
FÖRSTNER, reposition forceps	697	GROSS, dressing forceps	1, 9, 35
FRASER-KELLY(CRILE), delicate hemostatic forceps	223	sponge and dressing forceps	134
FRAZIER, dura retractor	322	sponge forceps	1, 9, 35
raspatory	617	GRUENWALD, dissecting forceps	125
suction tubes	305	forceps, bayonet, shaped	112
FREER, chisels	656	Guides	815
fine wound retractor	322	Guide pins	815
gouge	656	Guide sheath	564
raspatories	596, 614, 616, 617	Guiding probes	203
FREER-YASARGIL, raspatory	614	GULEKE, bone rongeur	712
FRENZEL, tongue depressors	2	GUTHRIE, skin retractors	322
FRIEDMANN, bone rongeurs	708	GUYON, catheter guide	504
FRITSCH, abdominal retractors	383	introducer for catheter	504
FRYKHOLM, bone rongeur	714	kidney clamps	486-488
FUCHSIG, delicate hemostatic forceps	222	urethral dilating bougies	505
FUKUSHIMA DESING, suction tubes	309	GWILLIAM, hysterectomy hemostatic forceps	251
G			
GABRIEL, rectal speculum	466	H	
GALABINS, uterine probe	531	HAASE, reposition forceps	696, 697
Gall duct dilators	481	tamper	669
GALLAHER, bone file and rasp	691	HABERER, abdominal and intestinal spatula	391
GARDNER, WELLS, skull traction instrument	746	gastro, intestinal forceps	449
Gel ear ring bases	777	HAIGHT, rib retractor	581
GELPI, skin and vaginal retractor	408, 525	HAJEK, irrigating cannula	478
vaginal retractor	408, 525	mallet	670
GEMINI, dissecting and ligature forceps	238	retractor	338
GERALD, delicate dissection forceps	104	HAJEK-KOFLER, punches	723
micro forceps	101	HAKANSSON, bone rongeur	709
tissue forceps	118	HALLE, bone curettes	680
GERSTER, bone clamp	707	elevator	596, 615
GIERTZ, STILLE, rib shear	609	HALSEY, HARDTIPS needle holders	176, 177
GIGLI, wire saws	749, 810, 832	needle holders	170
GILLIES, delicate dissecting forceps	104	HALSTED, delicate hemostatic forceps	222
electrosurgical instruments	854	HALSTED-MOSQUITO, delicate hemostatic forcep	218, 223
fine wound retractors	323	Hand drill	813
HARDTIPS needle holder	181	Hand grips	655
needle holders	174	Hand stabilizers	824
osteotomes	659	Hand valve and connection hose	561
suction tube	307	Handle for blade	417, 790, 791
tissue forceps	119	HARDCOATED dissecting scissors	94
GILSBACH, combined retractor semi, circular basic bar	772	HARDCOATED dissecting scissors, Gripcut	95
combined retractors	772	HARDCOATED transsphenoidal specula	778
combined retractor fixation attachments	773	HARDTIPS bone file and rasps	692, 693
combined retractor handrest bar	773	HARDTIPS delicate ligature scissors	80
combined retractor, frame	772	HARDTIPS delicate scissors	80
combined retractor, holding rod	772	HARDTIPS dissecting forceps	85, 124, 125
retractor system	772-774	HARDTIPS dissecting scissors, Gripcut	90
Gland and the foreskin forceps	500	HARDTIPS hysterectomy scissors	84
GLASSER, DIAMOTE micro needle holders	166	HARDTIPS ligature scissors, Gripcut	88, 89
GLOVER, ATRAUMATIC anastomosis clamps	266	HARDTIPS needle holders	179, 183, 184, 187, 190, 191
ATRAUMATIC bulldog clamps	217	HARDTIPS needle holder with scissors	181
		HARDTIPS surgical scissors	80, 81

HARDTIPS surgical scissors, Gripcut	89	HOHMANN, bone levers	639
HARDTIPS wire cutting scissors	84, 805	HOHMANN-ALDINGER, bone lever	646
HARDTIPS wire twisters	182, 802	HOLZBACH, abdominal retractors	421, 422
HARDY, curettes	784	hysterectomy hemostatic forceps	251
dissectors	780	HOPT, ATRAUMATIC kidney & pancreas clamps	277
implant fork	782	HOSEMANN, delicate hemostatic forceps	475
HARDY-FAHLBUSCH, dissectors	780, 781	HOUSE, suction tubes	306, 310
HARRINGTON, lung spatulas	362	HOWARTH, raspatory	615
HARRINGTON-PEMBERTON, lung spatula	362	HÖSEL, HARDTIPS needle holder	191
HARTMANN, intestinal clamps	438	retractors	359, 460
cotton applicator	304	HUBER, biopsy forceps handle	555
delicate hemostatic forceps	218	HUDSON, perforators	747
intestinal clamps	439	tissue forceps	114
HARVEY, wire cutter, with carbide cutting	807	HUDSON-DOWNS, perforators	747
wire cutting scissors	79, 805	HUMBY, skin graft knife	21
HARVEY-JACKSON, self, retaining laminectomy retractor	405	HUNTER, splinter forceps	123, 839
HASSON, retractors	369	HURD, dissectors	619
HEANEY, ATRAUMATIC hysterectomy forceps	252	suture instruments, ligature needles	194
HARDTIPS needle holders	183		
needle holder	172	I	
peritoneum hysterectomy forceps	248	Incision scissors	45
uterine curette	560	INGE, lamina spreaders	419, 787
vaginal specula	518	Injection needle	564
HEANEY-BALLENTINE, hysterectomy hemostatic forceps	249	Interosseous knife	18, 830
HEANEY-REZEK, peritonum hysterectomy forceps	247	Intima dissectors	596, 759
HEATH, clip removing forceps	204	IRWIN MOORE, rongeur	733
mallets	672	IRWIN, self, retaining retractor	400
HEBRA, comedone extractor	840	ISRAEL, retractors	343
HEGAR, HARDTIPS needle holders	180	IVES-FANSLER, anoscope	465
needle holders	172		
uterine dilators	526	J	
HEGAR-MAYO-SEELEY, HARDTIPS needle holder	179	JACKSON, tendon seizing forceps	144, 825
HEGAR-OLSEN, HARDTIPS needle holder	181	vaginal speculas	515
HARDTIPS needle holder scissors	181	JACKSON-BURROWS, retractor	408
needle holders	174	tissue forceps	122
HEGENBARTH, clip applying forceps	204	JACOBS, uterine tenaculum forceps	537
HEIFETZ, brain spatulas	750	JACOBSON, bone curette	676
forceps for grasping tumor, tissue	111	delicate hemostatic forceps	219, 223
vessel spreader	754	dilators	755
HEIMING, kidney stone forceps	492	micro needle holders	162
HEISS, delicate hemostatic forceps	224	micro scissors	30
HEISTER, mouth gag	3	micro vessel knife	764
HELLBERG-KUPKA, HARDTIPS needle holder	188	JAGER, dura retractor	323
HEMANN-KNIGHT, rongeur	732	tendon seizing forceps	145
HEMINGWAY, bone curettes	677	JAMESON, dissecting scissors	49
Hemi, laminectomy hooks	790	needle holder	172
Hemi, laminectomy retractor	404	Supercut dissecting scissors	92
Hemorrhoidal ligators	471	JAMESON-WERBER, dissecting scissors	49
Hemorrhoidal ligator handle	471	JANSEN, bone curettes	676, 677
Hemorrhoids rubber	470	bone rongeurs	710
HENCKEL-TILLEY, rongeur	735	forceps, bayonet, shaped	112
HENDERSON, self, retaining retractor	399	raspatory	624
HENKE, raspatories	619	self, retaining retractor	395
HENNING, plaster spreader	797	JANSEN-MIDDLETON, septum forceps	779
HERFF, membrane puncturing forceps	565	JEFFERSON, delicate dissecting forceps	102
HERRECK, kidney pedicle clamps	489	delicate tissue forceps	115
HERTZLER, rib retractor	580, 423	self, retaining retractor	398
HERZ, tendon seizing forceps	144, 825	JENKNER, tunneling forceps	605
HESS, nerve root retractors	334	JEWETT, bending irons	816
HEY GROVES, bone holding forceps	704, 705	JOHNS-HOPKINS, apply forceps for vessel clip	214
HEYMANN, rongeur	732	bulldog clamps	214
HEYWOOD-SMITH, organ and tissue forceps	142, 474, 542	JOLL (FREEDMAN), thyroid vaginal retractor	409, 525
HEYWOOD-SMITH, tongue forceps	1, 8, 40, 141, 473, 543	JONECO, suture instrument ligature needle	198
HIBBS, gouges	661	JONES, towel clamp	155
osteotomes	661	JOSEPH, bone file and rasp	690
retractors	648	bone file and rasp	690
HIBBS-SPRATT, bone curettes	681	delicate scissors	34, 38
HILL, raspatory	618	double, edged nasal knives	16
HIRSCHMANN, rectal speculas	464	raspatory	621
Hib retractor	821	skin retractors	323
HOEN, raspatories	617	hand saw	825
rongeurs	742		

Supercut dissecting scissors	93	KOOS, micro vessel knives	764
JUDD-ALLIS, organ tissue grasping forcep	148	KÖNIG, guiding probes	201
K		raspatory	620
KADER, abdominal and intestinal spatula	390	wound and vein retractors	331
KALLMORGEN, vaginal speculas	516	KÖRTE, retractors	343, 376
KANTROWITZ, dissecting ligature forceps	241	KÖRTE-WAGNER, retractor	342
KAZANJIAN, bone cutting forceps	718	KRAMER, chisel	658
KEIBACK, dissecting and ligature forceps	245, 547	raspatories	624
KELLY, abdominal retractors	379	retractor	355
anoscope	465	rongeurs	740, 743
delicate hemostatic forceps	219	KRAUSE, biopsy forceps tip	555
delicate scissors	38	trocars	316
organ and tissue forceps	142, 542, 574	KRAYENBULH, nerve and vessel hooks	321, 756
proctoscope	466	KRISTELLER, vaginal speculas	512-515, 517
rectal speculas	464	KRONECKER, suture instruments ligature needles	194
retractors	353	KRONLEIN, hemostatic forceps	226
sphincteroscope	465	KUNTSCHER, reamers	820
KERN-LANE, bone holding forceps	702	T arm	820
KERN-MINI, bone holding forceps	703	KÜMMEL, retractor	376
KERPEL, bone curettes	683	KÜSTNER, uterine tenaculum forceps	538
KERRISON, bone punches	726-729	L	
punches	722, 725	LA GRANGE, delicate scissors	40
HARDCOATED bone punch	726, 727	LABORDE, thyroid dilators	409
KERSTING, ATRAUMATIC sigmoid anastomosis forceps	455	LAHEY, organ and tissue grasping forceps	151, 539
KEVORKIAN, biopsy forceps	554	retractor	351
Keys	662, 812, 813, 845	LAHEY(SWEET), dissecting and ligature forceps	245, 476
KEY, raspatories	629	LAHGENCBEK, HARDTIPS needle holders	189
KEYES, dermal punches	838	LAMBERT, KAY, ATRAUMATIC aorta anastomosis clamps	280
KIEBACK, ATRAUMATIC hysterectomy forceps	253	LAMBOTTE, bone holding forceps	706
paramerium scissors	60, 548	osteotomes	659, 662
KIELLAND, obstetrical forceps	569	raspatories	597, 626
KILLIAN, bone shears	77	LANCASTER, self, retaining retractor	394
probe	302	LANDAU, trocar	316
raspatories	615, 617	vaginal speculas	520
rectal specula	462	LANDOLT, cannula	315, 863
KILNER, delicate dissecting scissors	46	curette	781
dissecting scissors	47	dissectors	781
fine wound retractors	322, 324, 840	enuclation scissors	47
HARDTIPS needle holder	177	hook	781
needle holder	171	raspatory	623
retractors	332, 337	rongeur	740
KING'S COLLEGE HOSPITAL, cotton applicators	302	scalpel handles	25
KIRSCH, retractors	349	spoon	781
KIRSCHNER, abdominal retractors	429	spreader	779
guiding probe	203	suction tube	310
traction instruments	799	LANDOLT-REULEN, dissector	782
Kidney trays	864	hook	783
KLAPP, wound and vein retractor	333	raspatories	783
KLEINERT-KUTZ, fine wound retractors	323	LANDON, vaginal specula	518
tendon passing forceps	145	LANE, bone holding forceps	702, 703
KLEINSCHMIDT, appendectomy clamp	450	bone level	635
KLIMA-ROSEGGER, trocar	316	gastro, intestinal forceps	448
KLINIKUM BERLIN, tubing clamp	11	retractors	338
KLINKENBERGH, scissors for vascular surge	71	tissue forceps	120
Knee retractors	350, 351, 819	towel clamp	155
KNOWLES, bandage and cloth scissors	74	LANE-TRETHOWAN, bone level	635
KOCHER, bladder retractor	495	LANG-STEVENSON, intestinal clamp	446
bone retractors	340	LANGE, retractor	330
depressor	391	LANGE-HOHMANN, bone levers	642
guiding probes	202	LANGENBECK, bone holding forceps	700
hemostatic forceps	230	elevators	634, 635
intestinal clamps	440, 442, 443	flap knife	18, 830
retractors	342, 348	metacarpal saw	832
suture instrument ligature needle	199	raspatories	597, 625, 626
wound and vein retractors	333	resection knife	19, 830
KOCHER-LANGENBECK, retractors	345	retractors	344, 346
KOCHER-OCHSNER, hemostatic forceps	231	LANGENBECK-GREEN, retractors	329
KOCHER-WAGNER, retractors	358	Laryngeal Mirrors	1, 6, 58
KOFLER, punch	724	LATHBURY-FARRELL, cotton applicators	302-304
KOGAN, endo speculas	529	LAWRENCE, dissecting and ligature forceps	243
KONIG, elevators	634	needle holder	170

LAZAR, micro suture tying forceps	99	MAC DONALD, dissector	616
LEBSCHKE, conductor for wire saw	832	MAGILL, suction tubes	312
sternum chisel	606	tongue forceps	8
LEECH-WILKINSON, biopsy forceps	554	MAIER, sponge and dressing forceps	136
uterine cannulas	562	MAINGOT, hysterectomy hemostatic forceps	249
LEES, ATRAUMATIC bronchus clamps	281	Mallets	670, 671, 673, 823
LEGUEU, bladder spatula	495, 430	Mallet, pair of spare discs	671
LEITZ, ATRAUMATIC anastomosis clamp	291	MALTZ, bone file and rasp	690
LEKSELL, bone rongeur	714	Mamilla markers	7
bone rongeur	714	Mammaria retractor	588
LEKSELL-STILLE, bone rongeur	715	MANNERFELT, gouge	658
LELAND-JONES, ATRAUMATIC peripheral vascular clamps	270	osteotomes	658
LEMBERT, bone rongeur	708	raspatories	622
bone curettes	680	retractors, triangle handle	327, 328
bone rongeurs	710	MARQUARD, bone rongeur	713
raspatories	621	MARTIN, pelvimeter	564
suction tubes	307	retractor	360, 521
LERICHE, delicate hemostatic forceps	220	MARTINI, bone curettes	676
retractors	375	MASING, cartilage slitting knife	16
LEWIN, bone clamp	698	HARDTIPS needle holder	176
LEWIS, bone file and rasps	690	osteotomes	659
LEWKOWITZ, placenta and ovum forceps	575	retractor	330
LEXER, dissecting scissors	55	MASSON, HARDTIPS needle holder	184
gouges	663, 664	needle holder	173
HARDTIPS dissecting scissors	82	MASSON-LUETHY, needle holder	173
HARDTIPS dissecting scissors, Gripcut	89	MATHEU, foreign body forcep	502
osteotomes	663, 665	HARDTIPS needle holders	190
LEXER-MINI, gouges	663	needle holders	175
osteotomes	663	rectal specula	463
LICHTENBERG, HARDTIPS needle holder	190	retractor	339
LINDEMANN, hand saw	825	vaginal speculas	518
LISTER, bandage and cloth scissors	74, 75	MATHIEU-STILLE, needle holders	175
sinus forceps	134	MAYFIELD, bone rongeur	713
LISTON, amputation knives	18, 830	headrests	777
bone cutting forceps	718, 720	headrest extension bar	777
LISTON-KEY-HORSLEY, bone cutting forceps	610, 721	headrest extension bar	777
LISTON-STILLE, bone cutting forceps	610, 721	skull clamp	776
LITTLER, dissecting scissors	46	table fixation attachments	776
LITTLEWOOD, uterine tenaculum forceps	538	MAYNIHAN, gall stone probe	478
Ligature guides	756	intestinal clamp	445
Ligature scissors	78	MAYO, dissecting scissors	53, 55, 82
Limiting bars	527	gall duct probe	478, 530
LLOYD-DAVIES (GOLIGHER'S), rectal scissors	58, 457	HARDTIPS dissecting scissors	81, 82
LLOYD-DAVIES, biopsy forceps	468	HARDTIPS dissecting scissors, Gripcut	89
LLOYD-DAVIS, sigmoid anastomosis forceps	453	safety pins	159
LOCKHART-MUMMERY, probes	300, 472	surgical and dissecting scissors	56
LOCKLIN, delicate scissors	40	Supercut dissecting scissors	93
LOCKWOOD, intestinal grasping forceps	150	MAYO-ADAMS, self, retaining retractor	400
LOGAN-REILL, self, retaining retractor	394	MAYO-HARRINGTON, dissecting scissors	55
LOPEZ-REINKE, tonsil dissector with suction	311	MAYO-HEGAR, needle holder	171, 172
LORNA, towel clamps	158	HARDTIPS needle holders	180
LOUTE, wire tightener	801	MAYO-LEXER, dissecting scissors	54
LOVE, nerve and nerve root retractors	334	HARDCOATED dissecting scissors	94
LOVE-GRUENWALD, rongeurs	739	HARDCOATED dissecting scissors, Gripcut	95
LOWER, dissecting and ligature forceps	245	HARDTIPS dissecting scissors	82
LOWMAN, bone clamps	707	HARDTIPS dissecting scissors, Gripcut	89
LOWMAN-GERSTER, bone clamp	707	MAYO-NOBLE, dissecting scissors	54
LOWMAN-HOGLUND, bone clamp	707	MAYO-ROBSON, intestinal clamps	444
LUC, rongeurs	733, 734	MAYO-STILLE, dissecting scissors	53
LUCAE, forceps, bayonet, shaped	112	surgical and dissecting scissors	56
LUCAS, bone curettes	677	MC CLINTOCK, placenta and ovum forceps	574
chisels	658	MC CLURE, micro scissors	28
gouges	658	MC GIVNEY, hemorrhoidal forceps	470
LUER, bone rongeurs	709, 711	MC INDOE, bone cutting forceps	719
hemorrhoidal forceps	473	delicate dissecting forceps	105
retractor	335	dura and skin hooks	324
LUER-FRIEDMANN, bone rongeur	709	tissue forceps	119
LUER-KÖRTE, gallstone scoops	479	MC KENTY, raspatory	620
LUER-STILLE, bone rongeurs	715, 716	MC KENZIE, clip applicators	752, 753
Lumbar micro dissection curettes	685	perforator	747
		MC KISSOCK, raspatory	625
		MEAD, bone rongeur	709

mallet	671	MUNCHEN, biopsy curette	550
mallet, pair of spare discs	671	MURPHY, retractors	344
raspatory	620	MURPHY-LANE, luxation lever	647
MEHDORN, vessel clips	208, 210	MUSEUX, organ and tissue forceps	151, 539
Meniscus forceps	818	uterine tenaculum forceps	537, 538
MERBURG MODELL, wire twister	803	MÜHLING, raspatories	623
Metal catheter	503	approximators	209
METZAMBAUM, electrosurgical scissors	855	MÜLLER, ATRAUMATIC rectal anastomosis clamp	456
dissecting scissors	35, 50, 52	ATRAUMATIC vessel clips	213
HARDCOATED dissecting scissors	94	fine wound retractors	322
HARDCOATED dissecting scissors, Gripcut	90, 95	HARDTIPS needle holder	185, 459
HARDTIPS dissecting scissors	85-87	ligature forceps	212
HARDTIPS dissecting scissors, Gripcut	90, 91	micro forceps	100
Supercut dissecting scissors	92	micro needle holders	162
METZENBAUM-NELSON, HARDTIPS dissecting scissors	87	micro scissors	33
MEYER, reposition forceps	697	rectal scissors	59, 458
MEYERDING, retractors	332, 357	retractors	385, 497
self, retaining laminectomy retractors	407	vessel clips, non, traumatic	212
self, retaining retractors	406		
MICHEL, clip applying & removing forceps	204	N	
clip applying forceps	204	NABATOFF, varix instruments	599
rhinoscopic mirror	6	NAGELE, obstetrical forceps	568
MICRO-ADSON, delicate dissecting forceps	102, 128	Nail cutters	5
delicate forceps	114	Nail extracting forceps	824
delicate tissue forceps, Titanium	129	Nail file	5
dissecting and ligature forceps	235	Nail scissors	1, 4, 5, 78
MICRO-ADSON-BEIMER, delicate forceps	114	NAUNTON MORGAN, HARDTIPS needle holder	185
MICRO-HALSTED, delicate hemostatic forceps	218	speculas	466
MIDDELDORPF, retractors	352	Needle cases	205
MIKULICZ, abdominal retractors	378, 379, 387	NEGUS, hemostatic forceps	234
hemostatic forceps	234	suction dissector	311
peritoneum forceps	246	NELATON, probe	300
peritoneum hysterectomy forceps	247	NELSON, lung grasping forceps	122
MILLER, bone file and rasps	691	NELSON-METZENBAUM, dissecting scissors	52
MILLES, micro scissors	30	HARDTIPS dissecting scissors	86
MILLIGAN, raspatory	617	HARDTIPS dissecting scissors, Gripcut	91
MILLIN, bladder neck spreader	495	NELSON-METZENBAUM(MC INDOE), HARDTIPS dissecting scissors	86
bladder retractors	494, 430	Nerve and nerve root retractor	334
ligature holding forceps	192, 496	Nerve dissecting scissors	35, 49
MILLS, cardiovascular scissors	68, 477	NICOLA, curettes	785
MINI-FINOCHIETTO, thoracic retractor	591	raspatory	782
MISKIMON, self, retaining laminectomy retractor	403	NIEDERDELLMANN, osteotomes	662
MITCHELLS, raspatory	626	NISSEN, delicate hemostatic forceps	222
MIXTER, dissecting and ligature forceps	243, 245, 475	dissecting and ligature forceps	244, 475
MIXTER-O'SHAUGHNESSY, dissecting and ligature forceps	240	NOON, ATRAUMATIC bulldog clamp	262
Micro dissectors	596, 761, 762	NORFLOK AND NORWICH, self, retaining laminectomy retractor	403
Micro forceps	98, 101, 838, 844	NORTHBENT, ligature scissors	78
Micro forceps, Titanium	128	NORTHFIELD, bone rongeur	712
Micro hooks	762	NOTO, organ and tissue forceps	142, 542
Micro ligature scissors	31	NOVAK-SCHOECKAERT, biopsy curette	550
Micro needle holders	162, 163	NOYES, eye scissors	29
Micro raspatory	762	NUSSBAUM, intestinal clamps	445
Micro ring forceps	101		
Micro scissors	28, 30-32, 844	O	
Micro scoops	762	O'CONNELL, dissector	617
Micro suture tying forceps	99, 101	O'SHAUGHNESSY, dissecting and ligature forceps	239, 240
Micro vascular scissors	66	O'SULLIVAN-O, CONNOER, abdominal retractors	426
Microscopic needles	845	Obstetric lever	569
Mini reamer	815	OBWEGESER, ligature needles	810
Mini screw holder	815	osteotome	662
Mirror	758	retractors	347
Mirror handle	1, 6, 58	OCHSNER, ATRAUMATIC aorta clamp	277
MOLLISON, self, retaining retractors	397, 400	gall duct probe	478
MOLT, raspatory	620	ligature forceps	107
MORE, protheses extractor	821	OFFICER, tissue forceps	121
MORRIS, ATRAUMATIC sigmoid anastomosis forceps	73, 454	OLDBERG, rongeur	740
retractors	356	OLIVECRONA, bone rongeur	712
MORSE, sternum spreaders	586	brain spatulas	750
Mouth gags	3	trigeminal knife	17
MOYNIHAN, delicate hemostatic forceps	219	OLLIER, retractor, deep form	343
hemostatic forceps	232, 475	OMBREDANNE, mallet	672
MUHLING, bone shears	77		

Organ and tissue forceps	152, 541	Prostate retractor	377, 497
Osteotomes	656, 822	Protheses extractors	821
OVERHOLT, dissecting and ligature forceps	237	Protheses pusher	821
OVERHOL-MIXTER, dissecting and ligature forceps	236	PROVIDENCE, delicate hemostatic forceps	219
OVERHOLT-GIESSENDOERFER, dissecting and ligature forceps	236, 238	PUTTI, bone file and rasps	693
P			
PAPAVERO, bayonet chisel	779	Q	
PAPAVERO-CASPAR, hypophysectomy speculas	778	QUERVAIN, elevator	634
PAPAVERO-HARTMANN, speculum	778	QUINBY, delicate scissors	39
PARKER, retractors	336	R	
PARKS, anostomosis blade	467	R.N.O.H, bone biopsy trephine	812
rectal blades	467	RAABE, suction tubes	309
rectal retractors	467	RAGNEL, dissecting scissors	35
sphincter blade	467	retractor	335
PARRY, COOLEY, ATRAUMATIC anastomosis clamp	291	RAMPLEY, sponge and dressing forceps	140
PARTSCH, chisels	656	RAMSEY, dissecting forceps	107
gouges	657	tissue forceps	121
raspatories	620	RANDALL, biopsy curette	550
PASSOW, tampers	669	kidney stone forceps	492, 493
PAUL, retractor	333	RANEY, clip applicator	752
PAULSEN, raspatories	622	RANKIN, delicate hemostatic forceps	221
PAYR, guiding probes	202	Raspatories	615, 621, 623, 630, 631, 633, 761
intestinal clamps	447	RAY, curettes	784
pylorus clamp	447	Reamers	811, 823
PEAN, hemostatic forceps	226, 227, 229, 233, 486	Reamers and awls	811
tubing clamp	11	RECAIMER, uterine scoops	557
ATRAUMATIC hemostatic forceps	260	placenta and ovum curettes	559
PEDERSON, vaginal speculas	510	Rectal scissors	458
PELKMANN, foreign body forceps	154, 482, 532	Rectal speculas	462
PENFIELD, dissectors	616, 618	REDON, guide needles	317
raspatory	615	REILL, micro needle holders	163, 844
PENNINGTON, intestinal grasping forceps	150	reposition forceps	696
raspatory	619	tendon strippers	826
PENNYBACKER, bone rongeur	712	wire cutter, with carbide cutting	807, 815
probe dissector	614	REIN-KUPKA, HARDTIPS needle holders	188
ronjur	736	REMINGTON-HOBB, electrosurgical instruments	854
raspatory	621	Removing the forceps screw	817
PERCY, amputation retractors	834	Reposition forceps	696, 697, 698, 700
Perforated trays	528	RESANO, cartilage scissors	57
Perforator	747	RESONE, ATRAUMATIC sigmoid anastomosis forceps	455
Periosteum knife	19, 830	Retractors	329, 346, 351, 365, 649-655, 845
PERKINS, self, retaining retractors	398	Retractor holder rod	771, 773
PERWITZSCHKY, delicate scissors	39	Retractor placing handle	414
Phalangeal knife	19, 830	Retractor, flexible arms	774
PHANEUF, peritoneum hysterectomy forceps	248	Retractor, holder for forceps	773
PICCOLO, cotton applicators	304	Retractor, holding and fixation attachments	770, 774
PIERCE, raspatory	619	Retractor, table fixation joints	771, 773
trocar	316	REVERDIN, abdominal and intestinal spatula	391
PIPER, obstetrical forceps	569	suture instruments, reverdin needles	193
PITHA, foreign body forceps	154, 502	REYNOLDS, dissecting scissors	49
Placenta and ovum forceps	574	REYNOLDS-JAMESON, vascular scissors	35
Plaster and cloth scissors	76, 795	RIBBON, abdominal and intestinal spatulas	391
Plaster cutting scissors	75, 794	RICHARD, abdominal retractors	421
Plaster spreaders	797	RICHARDSON, retractors	353, 354
Plate bending and contouring device	816	RICHARDSON-EASTMAN, retractors	354
Plate holding forceps	814	RICHES, electrosurgical forceps	855
PLESTER, self, retaining retractors	399, 400	RICHTER, punch	724
suction tubes	306	special retractor	408, 525
POIRIER, tissue grasping forceps	146	Rib shear	609, 835
POOL, suction cannulas	313	RNTNE, self, retaining retractor	398
Popliteal retractors	430	ROBERTS, hemostatic forceps	232, 233
POTTS, dissecting scissors	49	raspatory	627
POTTS-DE MARTEL, cardiovascular scissors	67, 68, 477	ROBIN, towel clamps	157
POTTS-SMITH, cardiovascular scissors	68	ROBIN-MASSE, abdominal retractors	421
scissors for vascular surger	71	ROCHARD, abdominal retractor fixation device	388
Pouch opener	565	abdominal retractors	388, 389, 488
POZZI, organ and tissue forceps	152, 153, 535, 541	ROCHESTER-CARMALT, hemostatic forceps	232
PRATT, rectal specula	463	ROCHESTER-OCHSNER, hemostatic forceps	230, 232
uterine dilators	526	ROCHESTER-PEAN, hemostatic forceps	228
PROB, guiding probe	201	ROEDER, towel clamp	156
Probes	300-302, 472, 827, 834		

ROGGE, sterilizing forceps	865	SCHWEDISCHES MODELL, dissecting forceps	107
ROLLET, skin retractors	322	SCOVILLE, self, retaining retractors	411, 412
Rongeurs	733, 742	SCOVILLE-HAVERFIELD, self, retaining retractor	412
ROSE, retractor	335	SCOVILLE-RICHTER, retractors	411
ROTUNDA, irrigation cannula	563	Screw extractor T arm	817
ROUX, retractors	336-338	Screwdrivers	414, 778, 790, 814
ROWBOTHAM, suction tube	312	Screwdrivers, T arm	817
RÖTTGEN-RUSKIN, bone rongeur	713	SCUDDER, stomach clamp	446
RUBIN, bone file and rasps	690	SEBILEAU, elevator	634
RUDD, hemorrhoidal ligator	470	SEDILLOT, raspatories	625
Rulers	7	SEGOND, hysterectomy hemostatic forceps	250
RUMEL, dissecting and ligature forceps	241	SEGOND-LANDAU, hysterectomy hemostatic forceps	250
RUMEL-BELMONT, tourniquets	602	SEIDL, vaginal speculas	512
RUSKIN, bone rongeur	713	SEIDLDBP, biopsy forceps	551
RUSKIN-LISTON, bone cutting forceps	719	SEIFFERT, probe	302
RUSS MODELL, tissue forceps	121	SELDIN, raspatories	627
RUST, amputation saws	833	Self, retaining laminectomy retractors	407
amputation saw blades	833	Self, retaining retractors	394, 395, 413- 417, 790
amputation saw handle	833	Self, retaining retractors, Titanium	416
RYDER, DIAMOTE micro needle holders	165, 166	Self, retaining retractor, Titanium blades	417, 790, 791
HARDTIPS needle holder	186, 187	SELLORS, rib spreader	608
S			
SAALFELD, comedone extractor	840	SELMAN, tissue forceps	121
SACHS, raspatory	615	SEMB, bone holding forceps	608, 699, 835
SAENGER, placenta and ovum forceps	573	bone rongeur	611, 716
SAMI, tumor tissue knives	765, 766	raspatories	596, 597, 627
SAROT, delicate hemostatic forceps	224	SEMKEN, delicate dissecting forceps	103
HARDTIPS needle holders	178	tissue forceps	116
hemostatic forceps	233	SEMM, abdominal retractors	428
SATINSKY, ATRAUMATIC bulldog clamp	287	vaginal speculas	511
scissors for vascular surge	71	SENN-MILLER, retractor	332
SAUER, self, retaining retractor	394	Sequestrum forceps	698
SAUERBRUCH, lung spatula	364	SEWALL, raspatory	615
pick, up forceps	11	SEYFFERT, vaginal speculas	511
retractors	348	SIEBOLD, uterine scissors	61
rib shears	609	SILVER, skin graft knife	20, 841
SAUERBRUCH-CORYLLOS, bone rongeurs	611, 717	SIMON, bone curettes	683, 688
SAUNDERS, biopsy curette	550	retractors	330, 360, 521
Scalpel handles	22-24, 499, 546	uterine scoops	556, 568
Scalpel handle, for microsurgery blades	767	SIMPSON, uterine probe	530
Scalpels	14, 15	SIMPSON-BRAUN, obstetrical forceps	568
SCHADEL, towel clamps	155	SIMS, gynecology scissors	63, 65
SCHAMBERG, curette	840	HARDTIPS uterine scissors	83
SCHUDE, bone curettes	678	HARDTIPS uterine scissors, Gripcut	90
SCHERBACK, vaginal specula, handle	524	rectal speculas	462-464
vaginal speculums	524	uterine probes	530
SCHINDLER, hysterectomy hemostatic forceps	251	uterine scoops	558
SCHINIC, dermatomes	20, 841	vaginal speculas	516
SCHMID, dissectors	596	Silicon divider	527
mouth gag	3	Sliding rails for dividers	527
vessel irrigating cannulas	603	Skin graft knife	20, 841
SCHMIEDEN, guiding probe	201	Skin straightening plate	20, 841
SCHMIEDEN-TAYLOR, dura scissors	69	SIMS-SIEBOLD, uterine scissors	58, 64
SCHNEIDER, raspatory	625	SMELLIE, placenta and ovum forceps	575
SCHNEIDER-SAUERBRUCH, raspatory	625	SMILLE, retractors	350, 819
SCHNIDT, hemostatic forceps	234	meniscus knives	818
SCHOEMAKER, colectomy	446	SMITH-BUIE, rectal retractor	467
SCHOENBORN, wound and vein retractor	331	SMITH-PETERSEN, gouges	661
SCHRÖDER, bone curettes	556, 688	osteotomes	661
organ and tissue forceps	151, 153, 535, 541	SOMER, uterine elevating forceps	544
uterine tenaculum forceps	535, 540	SPACKMAN, vulsillum cannula	563
SCHUBER, biopsy forceps	551	Spare blade	20, 841
SCHUKNECHT, suction tubes	308	Spatula	304
SCHULZ, biopptome	604	SPENCER, ligature scissors	78
retractors	349	SPENCER-WELLS, hemostatic forceps	227
SCHULZE, uterine cannula	562	Spermatocord fixation clamp	500
SCHUMACHER, biopsy forceps	551, 553, 555	Splinter forceps	123, 839
bone lever	643	Sponge and dressing forceps	134, 137
sternum scissors	606	Sponge forceps	1, 9, 38
umbilical cord scissors	72, 566	Spring hooks	753, 774
SCHUMACHER-WAGNER, bone lever	643	SPURLING, rongeurs	739
		ST.BARTS, nerve and vessel hook	320
		rongeurs	735, 736

ST.MARKS, pelvis retractors	384, 461	dissectors	596, 618
ST.MARKS-GIRONA, perineal retractor	467	dura retractor	323
ST.MARTIN, delicate eye forceps	114	grooved dissector	618
STAMM, bone cutting forceps	718	HARDTIPS needle holder	189
STAUSS, penis clamp	501	needle holder	175
STELLBRINK, synovectomy rongeurs	708	TÖNNIS-ADSON, dissecting scissors	50
STELZNER, rectal scissors	58, 457	HARDTIPS dissecting scissors	87
Sterile containers	528	HARDTIPS dissecting scissors, Gripcut	90
Sterile storage of dilators	527	TÖNNIS-MODIF., HARDTIPS needle holder	189
Sterilizing forceps	865	Traction hooks	799
STERNBERG, retractors	339	Traction instruments	746, 798, 799
Sternum retractors	588	Traction instrument, drill points	746
STEVENS, delicate dissecting scissors	48	Traction instrument, fixation discs	799
dissecting scissors	34	Traction instrument, screw	798
vascular and tendon scissors	48	Traction wrench	799
STIEGLITZ, splinter forceps	123, 839	TRAVERS, laminectomy retractor	401
STILLE, bone rongeur	714	Tray for instrument	774
chisels	660	TRELAT, raspatory	621
dissecting scissors	54	vaginal speculas	508
gouges	660	TREVES, tissue forceps	118
kidney clamps	488	Trigeminal knife	17
osteotomes	660, 835	Trocars	313, 316
plaster scissors	796	TROELTSCH, angular forceps	113
STILLE-BARRAYA, vascular and tumor forceps	120	TROTTER, bone rongeur	712
STILLE-RUSKIN, bone rongeur	715	TROUSSEAU, thyroid dilator	409
STOCKMANN, penis clamp	501	Tubing clamps	10, 11
STRANDELL-STILLE, retractors	329	TUDOR-EDWARDS, abdominal retractor	381
STRASSBURGER, tissue forceps	118	TUFFIER, abdominal and intestinal spatula	390
STRATTE, HARDTIPS needle holders	183	abdominal retractor	381
STRUCK, rib retractors	580	artery traction forceps	146
STRULLY, dura scissors	69	rib retractors	581
vascular scissors	69, 477	Tunneling tubes with conical tip	605
SUBRAMANIAN, ATRAUMATIC aorta clamp	278	TURANTAN, self, retaining retractors	410
Suction cannulas	313	TURNER WARWICK, retrograde bougie	505
Suction handle	313	abdominal retractors	427, 428
Suction tubes	307, 309-313	TUTTLE, lung grasping forceps	122
SUETIN, bandage scissors	76, 794	TÜBINGER, gall duct forceps	483
Supercut dissecting scissors	92	TÜBINGER, retractor	360, 521
Surgical scissors	41-44	TÜBINGER, self, retaining retractor	400
Suture forceps	121, 125		
Suture instrument, ligature needles	198, 810	U	
SWEDISH, dissectors	614	UCHIDA, radical hysterectomy instruments	547, 548
SWEET, bone punches	748	UFFENORDE, bone curette	683
SYME, raspatory	616	ULRICH, fistula knife	16
Synovectomy rongeur	708	sponge and dressing forceps	137
SYPERT, bone curettes	687	Umbilical cord scissors	72, 566
bone rongeur	717	Umbilical dilator	567
punch	724	UNNA, curette	840
rongeur	742	Ureter forceps	500
tampers	669	Urethral retractor	377
SYSTRUNK, surgical scissors	45, 825	US. ARMY, retractor	339
		Uterine probes	502
		Uterine tenaculum forceps	536
T			
TAGER, bone lever	647	V	
Tampers	669	Vacuum curettes	315, 561
TARNIER, obstetrical forceps	570	Vaginal speculas	517
TAYLOR, retractors	410, 648	VALLEIX, uterine probe	531
self, retaining retractors	412	Valve retractors	589
TEALE, uterine tenaculum forceps	538, 540	VANNAS, micro scissors	28-30, 844
Tendon interlaction forceps	144, 825	VARADY, varix instrument	599
Tendon strippers	826, 827	Vascular scissors	70, 477
THOMS-GAYLOR, biopsy forceps	551	Vascular and neurosurgery scissors	69
Thoracic retractors	588, 590	Vein scissors	29
THOREK, scissors for vascular surgery	71	Venous plexus clamp	498
THORPE, corneal forceps	102	VERBRUGGE, bone holding forceps	705
Thyroid retractor	409	VERBRUGGE-MÜLLER, bone levers	641
TISCHLER, biopsy forceps	555	VERHOEVEN, suction tubes	306
Tissue forceps	116-119, 129, 834, 838	VIDAL, lupus scraper	840
Tongue depressors	1, 2, 4	WISE, micro suture tying forceps	99
Tourniquets	602	VOLKMANN, bone curettes	676, 679
Towel clamps	155, 157-159, 865	bone retractors	341
TÖNNIS, dissecting scissors	51		

retractors	340, 341		
W			
WACHTEL, DIAMOTE micro dissecting forceps	127		
DIAMOTE micro tissue forceps	127		
HARDTIPS micro needle holder	164		
WAGENER, nerve and vessel hooks	320		
WAGNER, bone lever	637		
gouges	666		
mallet	671		
mallet disc, metal	671		
mallet disc, plastic	671		
raspatories	633		
rongeurs	742, 743		
bone level	635		
wire extension	810		
WALLICH, placenta and ovum curette	560		
WALTER, gouges	660		
osteotomes	659		
WALTON, biopsy forceps	469		
WANGENSTEEN, HARDTIPS dissecting forceps	125		
HARDTIPS needle holder	184		
needle holder	173		
WARD, raspatory	620		
WATSON-CHEYNE, raspatories	616		
WATSON-JONES, bone lever	638		
WAUGH, delicate tissue forceps	120		
WEBER, ATRAUMATIC aorta anastomosis clamps	279		
WEBSTER, HARDTIPS needle holder	176		
needle holder	170		
WECKER, Iridectomy scissors	29		
WEIL-BLAKESLEY, rongeurs	735		
WEISSBARTH, vaginal speculas	523		
WEITLANER, self, retaining retractors	396, 397, 401, 402, 845		
Weights	798		
Weight with chain	821		
WELLER, dissecting scissors	57		
menisküs pensi	818		
WERTHEIM, ATRAUMATIC hysterectomy forceps	252		
compression forceps	256, 490		
gyneecology scissors	65		
HARDTIPS dissecting scissors	83		
HARDTIPS needle holders	183		
hysterectomy forceps	254, 489		
hysterectomy hemostatic forceps	249, 250		
WERTHEIM-CULLEN, compression forceps	490		
WIENER MODELL, peritonum hysterectomy forceps	248		
WIKSROEM, dissecting and ligature forceps	240		
WILDE, angular forceps	113		
WILLETT, scalp flap forceps	571		
WILLIAMS, organ forceps	141		
WILLIGER, bone curettes	676, 679		
elevators	634		
raspatories	620		
retractors	332		
WILSON, hemostatic forceps	234		
organ and tissue forceps	153, 534		
WILSON-HEY, electrosurgical forceps	855		
WINKELMANN, circumcision clamps	501		
WINTER, placenta and ovum forceps	572		
WITT, sternal puncture needles	606		
Wire and screw cutting pliers	809		
Wire bases	528		
Wire bending pliers	804		
Wire cutter	806		
Wire cutters, with carbide cutting	807		
Wire cutter, with carbide cutting edges	806		
Wire cutting forceps	805, 806, 808		
Wire cutting scissors	79, 805		
Wire guides	800		
Wire holding forceps	803, 815		
Wire holding forceps, with carb cut edge	802		
Wire holding forceps		803, 804	
Wire tightener		799	
Wire twistors		803	
WOLFF, curettes		840	
plaster breakers		797	
Wooden mouth gag		3	
WOODSON, raspatory		617	
wound and trached retractors		325, 326, 500	
wound and vein retractors		331, 333	
WÖRRLEIN, reposition tamper		698	
Wrenches		671, 746	
WRIGLEY, obstetrical forceps		569	
WULLSTEIN, self, retaining retractors		398	
suction tubes		307, 308	
Y			
YANKAUER, suction cannula		314, 607	
suction tube		314	
YASARGIL, canulla		311	
clip applicators		768	
clip applicators, Titanium		769	
dissectors		759	
forceps for grasping tumor, tissue		110, 111	
micro dissectors		763	
micro needle holder		162	
micro raspatories		763	
micro scissors		30	
micro scoop		763	
micro vessel knives		764	
movable micro mirror		758	
rongeurs		740	
spring hooks		753	
suction tubes		312	
LEYLA retractors		770	
LEYLA retractor, coupling head		771	
LEYLA retractor, fixation attachments		771	
LEYLA retractor, fixation bases		770	
LEYLA retractor, flexible arms		770	
YEOMAN, biopsy forceps		468	
YOUNG, prostate retractors		497	
YOUNG-HRYNTSCHAK, boomerang needle holder		192, 499	
Z			
ZENKER, dissecting and ligature forceps		242	
retractors		361	
ZIELKE, gouges		664	
ZOELLNER, suction tubes		306, 308	
ZUFAL-JANSEN, bone rongeur		713	
ZWEIFEL, HARDTIPS needle holders		191	

0-9

Sayısal İndeks
Numerical Index

 ARGENT

Kat. No. Cat. No.	Sayfa. Page.	Kat. No. Cat. No.	Sayfa. Page.	Kat. No. Cat. No.	Sayfa. Page.	Kat. No. Cat. No.	Sayfa. Page.
AC 300.01	1, 6, 58	FD 060.01	764	AA 156.00	831	FM 151.00	33
AC 300.02	6	FD 060.02	764	AA 160.00	19, 830	FM 152.00	33
AC 300.03	6	FD 060.03	764	AA 161.00	19, 830	FM 155.00	33
AC 300.04	6	FD 062.00	764	AA 163.00	19, 830	FM 157.00	33
AC 300.05	6	FD 062.01	764	AA 165.00	831	FM 158.00	33
AC 300.06	6	FD 062.02	764	AA 175.00	795	FM 168.00	32
AC 300.07	6	FD 062.03	764	BA 182.00	21, 841	FM 168.01	32
AC 300.08	6	FD 064.00	764	BA 182.01	20, 841	FM 168.03	32
AC 300.09	6	FD 065.00	765	BA 184.00	20, 841	FM 168.04	32
AC 300.10	6	FD 065.01	765	BA 185.00	21	FM 168.06	32
AC 300.11	6	FD 065.02	765	BA 186.00P	20, 841	FM 168.09	30
AC 300.12	6	FD 065.03	765	BA 187.00	21	FM 168.10	32
AC 300.13	6	FD 065.04	765	BA 188.00	20, 841	FM 168.11	32
AC 302.01	1, 6, 58	FD 065.05	765	BA 188.01	20, 841	FM 168.13	32
AC 302.02	6	FD 065.06	765	BA 190.00	21	FM 168.14	32
AC 302.03	6	FD 065.07	765	OL 200.00	838	FM 168.16	32
AC 302.04	6	FD 065.10	765	OL 200.01	838	FM 168.18	30
AC 302.05	6	FD 065.11	765	OL 200.02	838	FM 168.19	30
AC 302.06	6	FD 065.12	765	OL 200.03	838	FM 168.30	32
AC 302.07	6	FD 065.13	765	OL 200.04	838	FM 168.31	32
AC 302.08	6	FD 065.14	765	OL 200.06	838	FM 168.33	32
AC 302.09	6	FD 065.15	765	HH 215.00	840	FM 168.34	32
AC 302.10	6	FD 065.16	765	HH 217.00	840	FM 168.36	32
AC 302.11	6	FD 065.17	765	HH 218.00	840	FM 168.50	32
AC 302.12	6	FD 066.01	766	OF 228.00	845	FM 168.51	32
AC 302.13	6	FD 066.02	766	OF 229.00	845	FM 168.53	32
AC 304.00	6	FD 066.03	766	FO 515.00	818	FM 168.54	32
AC 306.00	1, 6, 58	FD 066.04	766	FO 516.00	818	FM 168.56	32
AC 308.01	6	FD 067.01	766	FO 517.00	818	FM 169.00	32
AC 308.02	6	FD 067.02	766	OF 610.01	565	FM 169.01	32
AC 320.01	758	FD 070.00	767			FM 169.03	32
AC 325.01	758	FD 071.00	767			FM 169.04	32
AC 500.00	7	BA 101.01	15	FD 033.00	29	FM 169.06	32
AC 500.01	7	BA 101.03	15	FD 034.00	29	FM 169.09	31
AC 500.02	7	BA 101.04	15	FD 061.04	29	FM 169.10	32
AC 500.03	7	BA 101.06	15	FD 062.04	29	FM 169.11	32
AC 500.04	7	BA 101.07	15	FD 063.04	29	FM 169.13	32
AC 510.00	7	BA 101.08	15	FD 064.04	29	FM 169.14	32
AC 511.00	7	BA 101.09	15	FD 070.00	28, 844	FM 169.16	32
AC 512.00	7	BA 101.14	15	FD 071.00	28	FM 169.18	31
AC 523.00	7	BA 101.26	15	FD 073.00	28	FM 169.19	31
AC 610.01	564	BA 101.30	15	FD 076.00	28	FM 169.30	32
AC 620.01	564	BA 104.00	14	FD 078.00	29	FM 169.31	32
		BA 104.01	14	FD 079.00	29	FM 169.33	32
		BA 104.02	14	OC 100.00	28	FM 169.34	32
FD 010.00	24	BA 104.03	14	OC 101.00	28	FM 169.36	32
FD 012.00	24	BA 104.04	14	FD 102.00	28	BC 216.00	4
FD 014.00	24	BA 104.05	14	FD 103.00	28, 844	BC 216.10	4
FD 016.00	24	BA 106.00	14	FD 106.00	28	BC 216.11	4
FD 018.00	24	AA 108.00	831	FD 107.00	28	BC 217.00	1, 4, 78
FD 020.00	767	BA 110.01	16	FD 108.00	29	BC 217.01	1, 4, 78
FD 022.00	25	BA 111.02	17	OC 109.00	29	BC 218.00	1, 4, 78
FD 024.00	25	BA 118.00	16	FD 110.00	29	BC 219.00	5
FD 030.00	22	BA 118.01	16	FD 112.00	30	BC 219.10	5
FD 030.01	22	BA 118.02	16	FD 113.00	30	BC 219.11	5
FD 030.02	23	DM 122.00	17	FD 116.00	30	BC 219.12	5
FD 033.00	22	BA 124.00	17	FD 117.00	30	BC 220.00	36
FD 034.00	23	OM 125.00	17	FD 120.00	30	BC 221.00	36
FD 034.01	23, 546	FH 130.00	16	FD 121.00	30	BC 222.00	1, 4, 36
FD 035.00	22, 499	FH 134.00	16	FD 124.00	30	BC 222.01	36
FD 036.00	22, 499	FH 135.00	16	FD 125.00	30	BC 223.00	1, 4, 36
FD 036.01	22	FH 141.00	18, 830	FD 140.00	31	BC 223.01	36
FD 040.00	22	FH 143.00	18, 830	FD 141.00	31	BC 224.00	46
FD 040.01	22	FH 144.00	19, 830	FD 142.00	31	BC 224.00K	34
FD 040.02	23	FH 145.00	18, 831	FM 146.00	31	BC 225.00K	34
FD 043.00	23	FH 146.00	18, 830	FM 147.00	31	BC 226.00	36
FD 045.00	23	FH 146.01	18, 830	FM 148.00	31	BC 227.00	36
FD 046.00	23	FH 146.02	18, 830	FD 149.00	31	BC 228.00K	34
FD 060.00	764	FH 146.03	18, 830	FM 150.00	33	BC 229.00K	34

Kat. No. Cat. No.	Sayfa. Page.	Kat. No. Cat. No.	Sayfa. Page.	Kat. No. Cat. No.	Sayfa. Page.	Kat. No. Cat. No.	Sayfa. Page.
BC 230.00	37	BC 317.01	44	BC 430.00	51	BC 513.01	66
BC 230.01	37	BC 318.00	44	BC 430.01	51	BC 513.03	66
BC 231.00	37	BC 319.01	44	BC 431.00	51	BC 513.04	66
BC 231.01	37	BC 320.00	45	BC 435.00	51	BC 513.05	66
BC 232.00	37	BC 321.00	45	BC 440.00	56	BC 513.10	66
BC 233.00	37	BC 321.01	45	BC 440.01	56	BC 513.11	66
BC 234.00	37	BC 330.01	45	BC 440.02	56	BC 513.13	66
DO235.00	37	BC 330.02	45	BC 441.00	56	BC 513.14	66
DO236.00	37	BC 330.03	45	BC 441.01	56	BC 513.15	66
BC 237.00	38	OC 360.00	46	BC 441.02	56	BC 513.30	66
BC 238.00	38	BC 365.00	46	BC 442.00	56	BC 513.31	66
BC 239.00	38	BC 366.00	46	BC 442.01	56	BC 513.33	66
BC 240.00	38	OK 368.00	46	BC 443.00	56	BC 513.34	66
BC 241.00	38	OK 370.00	47	BC 443.01	56	BC 514.01	68
BC 242.00	38	OK 370.01	47	BC 444.00	54	BC 515.35	66
BC 243.00	38	BC 380.00	46	BC 445.00	54	BC 516.01	68
BC 250.00	38	BC 382.00	47	BC 446.00	53	BC 517.01	68
BC 250.00K	34	BC 382.01	47	BC 446.01	53	BC 520.00	69
BC 251.00	38	BC 384.00	49	BC 447.00	53	BC 521.00	70, 498
BC 251.00K	34	BC 385.00	49	BC 447.01	53	OM522.00	39
BC 252.00	38	BC 386.00	49	BC 448.00	54	BC 523.00	39
BC 253.00	38	BC 386.00K	35	BC 449.00	53	BC 526.00	69, 477
BC 258.00	49	BC 387.00	49	BC 449.01	53	BC 527.00	69
BC 258.00K	35	BC 387.01	49	BC 450.00	53	BC 527.01	69
BC 260.00	39	BC 390.00	48	BC 450.01	53	BC 528.00	69
BC 261.00	39	BC 390.00K	34	BC 451.00	54	BC 529.00	70, 477
DO264.00	39	BC 391.00	48	BC 452.00	54	BC 532.00	40
BC 265.00	47	BC 391.00K	34	BC 453.00	54	DO 533.00	40
OK266.00	47	BC 392.00	48	BC 454.00	55	DO 534.00	40
OC268.00	47	BC 392.00K	34	BC 455.00	55	BC 540.00	39
BC 310.00	41	BC 393.00	48	BC 456.00	55	BC 542.00	40
BC 310.01	41	BC 393.00K	34	BC 457.00	55	BC 546.00	40
BC 310.02	41	BC 394.00	48	BC 458.00	55	BC 568.00	70
BC 310.03	41	BC 395.00	48	BC 458.01	55	BC 569.00	71
BC 310.04	41	BC 396.00	48	BC 459.00	55	BC 570.00	71
BC 310.05	41	BC 396.10	48	BC 459.01	55	BC 571.04	58, 457
BC 310.06	41	OK 397.00	48	BC 459.02	55	BC 572.00	71
BC 310.07	41	BC 398.00K	35	BC 460.00	62	BC 573.00	71
BC 310.08	41	BC 398.10K	35	BC 461.00	62	BC 575.00	59
BC 311.01	41	BC 398.11K	35	BC 462.00	62	BC 576.04	58, 457
BC 311.02	41	OK 410.00	50	BC 462.01	62	BC 577.04	58
BC 311.03	41	BC 411.00	50	BC 463.00	63	BC 578.00	59, 458
BC 311.04	41	BC 412.00	50	BC 463.01	63	BC 579.04	458
BC 311.05	41	BC 412.00K	35	BC 467.00	63	ET 600.00	72, 566
BC 311.06	41	BC 413.00	50	BC 467.01	63	ET 602.00	72, 566
BC 311.07	41	BC 413.00K	35	BC 468.00	63	BC 603.00	72, 566
BC 312.02	42	BC 414.00	50	BC 468.01	63	BC 603.01	72, 566
BC 312.03	42	BC 414.05	50	BC 470.00	65	ET 604.00	73, 567
BC 312.04	42	BC 415.00	49	BC 470.01	65	ET 604.01	73, 606, 567
BC 312.05	42	BC 416.00	50	BC 470.02	65	ET 610.00	73, 567
BC 312.06	42	BC 416.01	50	BC 472.00	65	ET 612.02	64
BC 313.01	42	BC 418.00	51	BC 474.00	65	ET 613.02	64
BC 313.02	42	BC 418.01	51	BC 490.00	61	ET 614.00	60, 548
BC 313.03	42	BC 419.00	51	BC 491.00	61	ET 614.02	60, 548
BC 313.04	42	BC 420.00	52	BC 492.00	58, 64	ET 615.00	60, 548
BC 313.05	42	BC 420.01	52	BC 502.00	67	ET 615.02	60, 548
BC 313.06	42	BC 420.02	52	BC 502.01	67	AA 616.00	835
BC 314.01	43	BC 421.00	52	BC 504.00	67	AA 617.00	835
BC 314.02	43	BC 421.01	52	BC 504.01	67	BC 620.00	57
BC 314.03	43	BC 421.02	52	BC 504.02	67	BC 622.00	74
BC 314.04	43	BC 422.00	52	BC 506.00	67	BC 623.00	74
BC 314.05	43	BC 422.01	52	BC 506.01	67	BC 624.00	74
BC 315.01	43	BC 422.02	52	BC 506.02	67	BC 624.01	74
BC 315.02	43	BC 422.03	52	BC 508.00	67	BC 625.00	74
BC 315.03	43	BC 423.00	52	BC 508.01	67	BC 625.01	74
BC 315.04	43	BC 423.01	52	BC 510.01	68	BC 625.02	74
BC 316.00	44	BC 423.02	52	BC 511.01	68, 477	BC 625.03	74
BC 316.01	44	BC 423.03	52	BC 512.01	68, 477	BC 626.00	75
BC 317.00	44	BC 425.00	57	BC 513.00	66	LX 630.00	75, 794

Kat. No. Cat. No.	Sayfa. Page.	Kat. No. Cat. No.	Sayfa. Page.	Kat. No. Cat. No.	Sayfa. Page.	Kat. No. Cat. No.	Sayfa. Page.
BC 631.00	76						
BC 632.00	73						
LX 633.00	76, 794	BC 758.00	87	BD 024.04	114	FD 176.01	111
BC 640.00	78	BC 758.00G	90	BD 103.00	98, 838, 844	FD 176.03	111
BC 640.01	78	BC 760.00	86	BD 103.00T	128	FD 177.01	111
BC 642.00	78	BC 761.00G	91	BD 103.01	98	FD 177.03	111
BC 643.00	78	BC 761.01	86	BD 104.00	98, 838	FD 183.01	111
LX 653.00	75, 794	BC 763.00	87	BD 104.00T	128	FD 185.01	111
LX 653.01	75, 794	BC 763.01	87	BD 105.00	98	FD 198.00	101
LX 654.00	75, 794	BC 763.02	87	BD 106.00	98	FD 199.00	101
LX 656.00	76, 795	BC 764.00	87	BD 107.00	99	FD 199.04	101
LX 658.00	76, 795	BC 764.00G	91	BD 108.00	98, 844	OC 203.00	102
BC 660.00	45, 825	BC 764.01	87	BD 109.00	98	BD 204.00	102
DP 661.00	79	BC 764.01G	91	BD 110.00	99	BD 204.00T	128
DP 662.00	79	BC 764.02	87	BD 113.00	99	BD 205.00	102
DP 663.00	79	BC 764.02G	91	FM116.01	100	BD 207.00	102
DP 664.00	79	BC 766.00	86	FM117.01	100	OC 210.00	103
BC 666.00	79, 805	BC 766.00G	91	FM118.01	100	OC 211.00	103
DP 668.00	79, 805	BC 768.00	86	FM119.01	100	OC 212.00	103
AA 690.00	835	BC 768.00G	91	FM120.00	100	BD 213.00	102
AA 690.01	835	BC 768.01	86	FM120.01	100	BD 214.00	102
OP 695.00	77	BC 768.01G	91	FM120.02	100	BD 215.00	103
FO 695.01	77	BC 768.02	86	FM121.00	100	BD 215.01	103
BC 710.00	80	BC 768.02G	91	FM122.00	100	BD 215.02	103
BC 711.00	80	BC 769.05	87	FM123.00	100	BD 215.03	103
BC 711.00G	89	BC 780.01B	94	BD 124.00	99	BD 215.04	103
DO712.00	80	BC 781.00	88	BD 125.00	99	BD 216.00	103
DO713.00	80	BC 781.01	88	BD 126.00	99	BD 216.01	103
DO715.00	80	BC 781.02	88	BD 127.00	99	BD 216.02	103
BC 720.03	80	BC 781.03	88	BD 128.00	99	BD 216.03	103
BC 722.00	81	BC 781.05	88	FD 130.00	101	BD 216.04	103
BC 723.03	81	BC 782.01B	94	FD 130.01	101	BD 217.00	103
BC 723.03G	89	BC 783.01B	94	FD 130.02	101	BD 218.00	103
BC 725.00	81	BC 783.03B	94	FD 131.00	101	BD 218.01	103
BC 725.01	81	BC 783.04B	94	FD 131.01	101	BD 219.00	104, 838
BC 726.00	81	BC 783.13B	94	FD 131.02	101	BD 220.00	104
BC 726.01	81	BC 783.14B	94	FD 135.00	101	BD 220.00T	130
BC 726.01G	89	BC 785.01B	94	FD 135.01	101	BD 220.01	838
BC 727.10	82	BC 785.02B	94	FD 138.00	101	BD 220.01T	130
BC 727.13	82	BC 790.00	84, 477	BC 144.00	112	BD 221.00	104
BC 728.11	82	BC 790.01B	95	BC 145.00	112	BD 222.00	105
BC 728.13	82	BC 792.01B	95	BC 145.01	112	BD 223.00	104
BC 730.00	82	BC 793.01B	95	BC 147.00	112	BD 223.00T	130
BC 730.00G	89	BC 793.03B	95	BC 148.00	112	BD 224.00	104
BC 731.00	82	BC 793.04B	95	BC 149.00	112	BD 224.00T	130
BC 731.00G	89	BC 793.13B	95	OL 150.00	112	BD 225.00	106
BC 738.00	83	BC 793.14B	95	BD 152.00	112	BD 225.01	106
BC 738.10	83	BC 795.01B	95	BD 153.00	112	BD 225.02	106
BC 740.00	83	BC 795.02B	95	BD 154.00	112	BD 225.02T	130
BC 740.00G	90	BC 798.00	84, 805	BD 156.00	113	BD 225.03	106
BC 740.01	83	BC 800.00	92	BD 156.01	113	BD 225.03T	130
BC 740.01G	90	BC 800.05	92	BD 156.02	113	BD 225.04	106
BC 740.05	83	BC 801.01	92	BD 156.03	113	BD 225.05	106
BC 742.00	84	BC 801.05	92	BD 157.00	113	BD 225.07	106
BC 743.00	84	BC 802.01	92	BD 158.00	113	BD 225.09	106
BC 750.00	85	BC 802.02	92	BD 159.00	113	BD 226.00	107
BC 751.00	85	BC 804.01	93	BD 165.00	110	BD 226.01	107
BC 751.00G	90	BC 804.05	93	BD 165.01	110	BD 227.00	104
BC 752.00	85	BC 805.00	92	BD 166.00	110	BD 230.00	105
BC 753.00	85	BC 805.05	92	BD 167.00	110	BD 232.00	104
BC 753.00G	90	BC 807.00	93	BD 167.01	110	BD 232.01	104
BC 755.00	85	BC 808.00	93	BD 168.00	110	BD 233.00	104
BC 755.01	85	BC 808.05	93	BD 168.01	110	BD 235.00	105
BC 756.00	85	LX 882.00	796	BD 169.00	110	BD 235.01	105
BC 756.00G	90	LX 884.00	796	BD 169.01	110	BD 236.00	105
BC 756.01	85	LX 885.00	796	FD 170.00	111	BD 238.00	105
BC 756.01G	90	LX 886.00	796	FD 170.01	111	BD 239.00	105
BC 756.02	85	BD 017.00	114	FD 171.00	111	BD 239.01	105
BC 756.02G	90	BD 018.00	114	FD 171.01	111	BD 240.00	106
BC 721.03	80	BC 780.00	88	FD 172.00	111	BD 240.00T	130
BC 807.03	93	BC 780.02	88	FD 172.01	111	BD 240.01	106
		BC 780.03	88				
		BC 780.05	88				

Kat. No. Cat. No.	Sayfa. Page.	Kat. No. Cat. No.	Sayfa. Page.	Kat. No. Cat. No.	Sayfa. Page.	Kat. No. Cat. No.	Sayfa. Page.
BD 240.01T	130	BD 306.01	116	BD 373.00	119	FM 606.06	126
BD 240.02	106	BD 308.00	116	BD 374.00	122	FM 606.08	126
BD 240.02T	130	BD 309.00	116	BD 380.00	119	FM 609.01T	128
BD 240.03	106, 834	BD 309.01	116	BD 381.00	119	FM 609.03T	128
BD 240.03T	130	BD 310.00	116	BD 382.00	120	FM 609.05T	128
BD 240.04	106, 834	BD 314.00	116	BD 382.01	120	BV 610.00	416
BD 240.05	106, 834	BD 314.01	116	BD 382.02	120	FM 610.01T	128
BD 240.05T	130	BD 320.00	114	BD 382.03	120	FM 610.03T	128
BD 240.06	106	BD 321.00	114	BD 383.00	121	FM 610.05T	128
BD 240.07	106, 836	BD 322.00	114	BD 383.01	121	FM 615.01	126
BD 242.00	107	BD 322.00T	129	BD 384.00	118	FM 615.03	126
BD 244.00	107	BD 323.00	114, 838	BD 384.01	118	FM 618.03	126
BD 244.01	107	BD 323.00T	129	BD 385.00	120	FM 618.05	126
BD 244.02	107	BD 324.00	114	BD 385.01	120	FM 630.02	127
BD 244.03	107	BD 324.00T	129	BD 385.03	120	FM 630.04	127
BD 245.00	107	BD 325.00	115	BD 386.00	120	FM 633.01	127
BD 247.00	107	BD 325.01	115	BD 386.01	120	FM 633.03	127
BD 248.00	107	BD 326.00	115	BD 387.00	118	FM 633.05	127
BD 250.00	98, 844	BD 326.01	115	BD 387.01	118	FM 633.08	127
BD 251.00	98, 844	BD 327.00	114	BD 388.00	120	FM 635.01	127
BD 252.00	98, 844	BD 328.00	114	BD 388.01	120	FM 635.03	127
BD 256.01	108	BD 329.00	115	BD 388.02	120	FM 635.05	127
BD 256.02	108	BD 330.00	115	BD 389.00	120	FM 635.08	127
BD 257.00	108	BD 331.00	115	BD 389.01	120	FM 637.00	127
BD 257.01	108	BD 340.00	115	BD 390.00	121	FM 660.03	127
BD 257.01T	128	BD 341.00	115	BD 390.01	121	FM 661.03	127
BD 257.02T	128	BD 341.02	115	BD 390.02	121	FM 665.03	127
BD 257.03T	128	OC 351.00	115	OC 391.00	121	FM 665.05	127
BD 258.03	108	BD 360.01	117	BD 392.00	122	FM 673.00	127
BD 258.04	108	BD 360.02	117	EA 394.00	122	FM 673.10	127
FC 260.00T	131	BD 360.02T	129	BD 395.00	121	FM 675.00	127
FC 260.01	108	BD 360.03	117	BD 396.00	122	FM 675.10	127
FC 260.02	108	BD 360.03T	129	BD 398.00	122	BF 004.00	134
FC 260.02T	131	BD 360.04	117, 834	BD 410.00	123, 839	BF 006.00	134
FC 260.04	108	BD 360.04T	129	BD 411.00	123, 839	BF 008.00	134
FC 260.06	108	BD 360.05	117, 834	BD 411.01	123, 839	BF 010.00	134
FB 261.00	108	BD 360.05T	129	BD 411.02	123, 839	BF 011.00	134
FB 261.03	108	BD 360.06	117, 834	BD 412.00	123, 839	BF 016.00	134
FB 261.05	108	BD 360.06T	129	BD 420.00	123, 839	BF 017.00	134
FB 262.00	109	BD 360.07	117	BD 421.00	123, 839	BF 019.00	134
FB 262.00T	131	BD 360.08	117	BD 422.00	123, 839	BF 022.00	1, 9, 35
FB 262.01	109	BD 360.09	117	BD 503.00	124	BF 023.00	1, 9, 35
FB 262.01T	131	BD 361.00	117	BD 510.00	124	BF 025.00	1, 9, 35
FB 262.02	109	BD 361.01	117	BD 510.01	124	BF 026.00	1, 9, 35
FB 262.03	109	BD 361.02	117	BD 511.00	124	BF 030.00	135
FB 263.00	109	BD 361.03	117	BD 512.00	124	OM 031.00	135
FB 263.00T	131	BD 361.05	117	BD 512.01	124	AN 038.00	8
FB 263.01	109	BD 361.06	117	BD 513.00	125	AN 038.01	8
FB 263.01T	131	BD 361.07	117	BD 516.00	124	AN 038.02	8
FB 263.03	109, 459	BD 361.09	117	BD 516.01	124	BF 042.00	1, 9, 38
FB 265.00	109	BD 362.00	117	BD 516.02	124	BF 043.00	1, 9, 38
FB 265.00T	131	BD 363.00	118, 838	BD 517.00	125	BF 044.00	1, 9, 38
FB 265.01	109	BD 363.01	118, 838	BD 517.01	125	BF 045.00	1, 9, 38
FB 265.01T	131	BD 364.00	119	BD 518.00	125	BF 045.04	137
FB 265.02	109	BD 365.00	118	BD 519.00	125	BF 050.00	136
FB 265.03	109	BD 365.01	118	BD 520.00	125	BF 051.00	136
FB 266.00	109	BD 366.00	118	BD 520.01	125	BF 054.00	136
FB 266.01	109	BD 367.00	118	BD 523.00	125	BF 055.00	136
FB 266.02	109	BD 368.00	118	BD 529.00	121	BF 056.00	137
FB 266.03	109	BD 369.00	118	FM 582.00	431	BF 057.00	137
FB 267.00	108	BD 370.00	119	FM 601.03	126	BF 058.00	137
FB 267.01	108	BD 370.01	119	FM 601.05	125	BF 058.03	137
FB 267.02	108	BD 370.02	119	FM 602.03	125	BF 059.00	137
FB 268.00	108	BD 370.03	119	FM 602.05	125	BF 070.00	139
BD 287.00	122	BD 370.04	119	FM 604.03	125	BF 071.00	139
OC 303.00	116	BD 371.00	119	FM 604.05	125	BF 072.00	139
OC 304.00	116	BD 371.01	119	FM 606.01	126	BF 080.00	140
OC 305.00	116	BD 371.02	119	FM 606.03	126	BF 081.00	140
BD 306.00	116	BD 372.00	122	FM 606.05	126	FM 608.01	126
FC 260.00	118	BD 360.00	117	FM 606.06	126	FM 608.03	126
				BD 384.02	121	FM 608.05	126
						FM 608.06	126
						FM 608.08	126

Kat. No. Cat. No.	Sayfa. Page.	Kat. No. Cat. No.	Sayfa. Page.	Kat. No. Cat. No.	Sayfa. Page.	Kat. No. Cat. No.	Sayfa. Page.
BF 082.00	140	EO 211.00	152, 541	BF 446.00	157	FD 112.00	162
BF 083.00	140	EO 215.02	540	BF 450.00	157	FD 113.00	162
BF 084.00	140	EO 216.02	540	BF 451.00	157	FD 114.00	162
BF 085.00	140	EO 217.02	540	BF 451.01	157	FD 115.00	162
BF 086.00	140, 474	EO 251.00	153, 535	BF 460.00	158	FD 116.00	162
BF 087.00	140, 474	EO 252.00	153, 534	BF 461.01	158	FD 117.00	162
EO 088.00	545	EO 253.01	535	BF 462.00	158	FD 118.00	162
AN 089.00	1, 8, 40	EO 255.01	153, 535	BF 464.00	158	FD 120.00	163
EA 092.00	473	EO 258.01	534	BF 469.00	158	FD 121.00	163
EA 092.01	473	EO 260.01	536	BF 469.01	158	FD 122.00	163
EO 120.00	142, 542	EO 262.01	536	BF 480.00	159	FD 123.00	163
BF 122.00	142, 542, 574	EO 265.01	536	BF 481.00	159	FD 124.00	163
BF 123.00	142	EO 270.01	534	BF 482.00	159	FD 125.00	163
EO 130.00	143, 473, 543	BF 300.00	144, 825	JG 500.00	159, 865	FD 126.00	844
EO 130.01	143, 473, 543	BF 302.00	144, 825	JG 510.00	159, 865	FD 127.00	163, 844
BF 140.00	146	BF 302.01	144	JG 510.01	159, 865	BM 130.00	163
BF 141.00	146	BF 310.00	144	JG 514.00	865	BM 131.00	163
EA 142.00	146	FO 311.00	144, 825	JG 514.01	865	FD 132.00	163
EA 143.00	146	FO 312.00	144, 825	JG 518.00	865	FD 133.00	163
EA 144.00	146	BF 330.00	145	EO 550.01	544	FD 134.00	163
EA 145.00	147	BF 331.00	145	ET 555.00	568	FD 135.00	163
EA 145.02	147	BF 331.01	145	ET 556.00	568	FM 139.00	162
EA 145.03	147	BF 332.00	145	ET 557.02	568	FM 139.10	162
EA 147.01	148	BF 332.01	145	ET 558.02	568	FM 150.00	162
EA 147.03	148	BF 338.00	145	ET 559.02	569	FM 154.01	162
EA 148.00	146	EB 350.00	154	EO 560.01	544	BM 200.00	170
EA 150.00	147	EF 351.00	154, 502	ET 565.02	569	BM 202.00	170
EA 150.02	147	EB 352.00	482	ET 567.02	569	BM 203.00	170
EA 150.04	147	EO 354.00	154, 532	EO 570.01	545	BM 204.00	170
EA 150.06	147	EO 355.00	154, 482, 532	ET 573.02	569	BM 206.00	170
EA 150.08	147	EO 360.02	532	EO 575.02	491, 544	BM 207.00	171
EA 150.10	147, 459	EO 362.02	532	EO 577.02	491, 545	BM 210.00	170
EA 150.12	147	EO 364.02	533	ET 578.04	570	BM 211.00	170
EA 156.00	148	EO 365.02	533	ET 579.04	570	BM 215.00	171
EA 158.00	148	EO 367.02	533	FF 590.01	571	BM 217.00	171
FB 159.00	148	EO 375.01	537	ET 593.01	571	BM 219.00	171
OM 165.00	151, 539	EO 376.01	537	ET 594.02	571	BM 221.00	171
EA 170.00	149	EO 377.00	540	EF 601.01	492	BM 223.01	171
EA 171.00	149	EO 378.02	538	EF 602.01	492	BM 223.03	171
EA 171.01	149	EO 379.02	538	EF 608.01	493	BM 230.00	172
FB 171.02	149	EO 380.02	537	EB 610.02	483	BM 230.01	172
EA 171.03	149	EO 380.03	537	EB 610.03	483	BM 230.02	172
EA 172.01	148	EO 380.04	537	EB 610.04	483	BM 230.03	172
MD 173.01	148	EO 381.02	537	EB 610.05	483	BM 230.04	172
EA 174.00	149	EO 381.04	537	EB 612.01	483	BM 231.00	172
EA 174.01	149	EO 382.02	538	EB 612.02	483	BM 231.01	172
EA 178.00	141	EO 382.04	538	EB 613.00	483	BM 231.02	172
EA 180.00	150	EO 383.02	538	EB 614.01	493	BM 232.00	172
EA 182.00	150	ET 387.02	565	EB 620.00	482, 602	BM 234.00	172
EA 184.00	149	BF 400.00	155	EB 621.00	482	BM 236.00	172
EA 184.01	149	BF 401.00	155	ET 700.01	572	BM 237.00	172
BH 185.00	150	BF 402.00	155	ET 700.02	572	BM 238.00	173
EA 185.02	150	BF 403.00	155	ET 702.01	572	BM 239.00	173
EA 186.00	150	BF 404.00	155	ET 702.02	572	BM 240.00	173
EA 187.00	143	BF 410.00	155	ET 702.03	572	BM 250.00	175
EA 187.01	143	BF 412.00	155	ET 705.01	572	BM 251.00	175
FB 189.00	150	BF 420.00	155	ET 705.02	572	BM 260.00	174
AN 190.00	8, 141, 473, 543	BF 430.00	156	ET 710.02	574	BM 261.00	174
BH 192.00	1, 8, 41	BF 430.01	156	ET 720.02	573	BM 268.00	174
AN 193.00	1, 8, 41	BF 430.02	156	ET 721.02	573	BM 269.00	174
BH 194.00	141	BF 431.00	156	ET 722.02	573	BM 285.00	175
EO 196.00	474, 543	BF 431.01	156	EF 730.02	575	BM 285.01	175
EO 198.00	142, 474, 542	BF 439.00	156	EF 731.02	575	BM 285.02	175
BF 200.00	151, 539	BF 440.00	157	ET 735.02	575	BM 290.00	175
BF 201.00	151, 539	BF 440.05	157	ET 740.02	574	BM 290.01	175
BF 202.00	151, 539	BF 442.00	156	BF 431.01	162	BM 301.00	164
EO 206.00	151, 540	BF 443.00	534	BM 110.00	162	BM 303.00	164
EO 208.00	151, 541	BF 444.00	156, 534	BM 111.00	162	BM 305.00	164
EO 210.00	152, 541	EO 445.01	534	EF 600.01	492	BM 305.01	164
EO 511.00	159	BF 420.01	155	EF 603.01	492	EF 543.01	496
		BF 420.02	155	EF 604.01	492	EF 536.00	496
				EF 605.01	492	EF 609.01	493
						EB 615.01	493

Kat. No. Cat. No.	Sayfa. Page.	Kat. No. Cat. No.	Sayfa. Page.	Kat. No. Cat. No.	Sayfa. Page.	Kat. No. Cat. No.	Sayfa. Page.
BM 307.00	165	FM 317.01	166	BM 373.02	183	BM 450.00	198
BM 307.04	165	FM 317.02	166	BM 374.00	183	BM 451.00	199
FM 308.00	164	FM 317.04	166	BM 380.00	186	BM 453.00	198
FM 308.01	164	FM 317.05	166	BM 380.01	186	BM 454.00	198
FM 310.01	168	BM 319.00	166	BM 380.02	186	BM 455.00	199
FM 310.02	168	BM 320.00	176	BM 380.03	186	BM 456.00	199
FM 310.03	168	BM 321.00	176	BM 380.04	186	DO 457.00	810
FM 310.04	168	BM 322.00	176	BM 381.00	186	DO 458.00	810
FM 310.05	168	BM 323.00	177	BM 381.01	186	BM 460.00	198, 810
FM 310.06	168	BM 324.00	187	BM 381.02	186	BM 461.00	199
FM 310.07	168	BM 324.01	187	BM 381.03	186	BM 465.00	200
FM 310.08	168	BM 324.03	187	BM 382.00	188	BM 465.01	200
FM 310.09	168	BM 325.00	177	BM 383.00	188	BM 466.00	200, 810
FM 310.10	168	BM 326.00	177	BM 384.00	189	BM 466.01	200
FM 310.21	168	BM 328.00	177	BM 385.00	187	BM 480.00	201
FM 310.22	168	BM 330.00	177	BM 385.01	187	BM 481.00	201
FM 310.23	168	BM 332.00	177	BM 387.00	189	BM 482.00	201
FM 310.24	168	BM 333.00	178	BM 388.00	188	BM 483.00	201
FM 310.25	168	BM 333.02	178	BM 389.01	190	BM 484.00	202
FM 310.26	168	BM 333.03	178	BM 389.02	190	BM 485.00	202
FM 310.27	168	BM 333.04	178	BM 389.03	190	BM 488.00	202
FM 310.28	168	BM 333.05	178	BM 390.00	189	BM 489.00	202
FM 310.29	168	BM 334.00	182, 802	BM 390.01	189	BM 491.00	203
FM 310.30	168	MD 335.00	182, 802	BM 391.00	189	BM 492.00	203
FM 310.31	168	BM 336.00	182, 802	BM 392.00	190	BM 494.00	203
FM 310.32	168	BM 337.01	182, 802	BM 392.01	190	BM 496.00	203
FM 310.33	168	BM 338.00	178	BM 392.02	190	BM 498.00	203
FM 310.34	168	BM 338.05	178	BM 393.00	190	KY 520.00	801
FM 310.35	168	BM 339.01	182, 802	BM 393.01	190	KY 522.00	801
FM 310.36	165	BM 340.00	181	BM 394.00	190	KY 529.00	801
FM 310.37	165	BM 341.00	181	BM 395.00	191	KY 529.01	801
FM 310.44	168	BM 342.00	181	BM 396.00	190	KY 529.02	801
FM 310.45	168	BM 343.01	181	BM 397.00	191	KY 529.03	801
FM 310.46	168	BM 344.00	178	BM 398.00	191	KY 529.05	801
FM 310.47	168	BM 344.01	178	BM 399.00	191	KY 529.06	801
FM 310.48	168	BM 345.00	178	BM 404.00	226	KY 529.07	801
FM 310.49	168	BM 345.01	178	BM 406.00	192, 499	KY 529.08	801
FM 310.91	166	BM 346.00	178	EF 408.00	192, 496	KY 529.09	801
FM 310.92	166	BM 346.01	178	BM 411.00	193	KY 529.10	801
FM 311.02	169	BM 346.02	178	BM 411.01	193	KY 530.01	800
FM 311.03	169	BM 346.03	178	BM 411.02	193	KY 530.03	800
FM 311.04	169	BM 346.04	178	BM 411.03	193	KY 531.01	800
FM 311.05	169	BM 346.05	179	BM 412.00	193	KY 531.03	800
FM 311.06	169	BM 347.00	179	BM 412.01	193	KY 532.01	800
FM 311.12	169	BM 347.01	179	BM 412.02	193	KY 533.00	810
FM 311.13	169	BM 347.02	179	BM 412.03	193	BN 601.00	204
FM 311.14	169	BM 350.00	179	BM 412.04	193	BN 605.00	204
FM 311.15	169	BM 350.01	179	BM 420.00	194	BN 620.00	204
FM 311.16	169	BM 353.00	185	BM 421.00	194	BN 621.00	204
FM 311.20	169	BM 354.00	185, 459	BM 422.00	194	BN 630.00	204
FM 311.21	169	BM 355.00	180	BM 423.00	194	BN 631.00	204
FM 311.22	169	BM 355.01	180	BM 424.00	194	FM 800.00	317
FM 311.25	169	BM 355.02	180	BM 425.00	194	FM 800.01	317
FM 311.26	169	BM 355.03	180	BM 428.00	195	FM 800.02	317
FM 311.27	169	BM 355.04	180	BM 429.00	195	FM 800.03	317
FM 312.00	164	BM 355.05	180	BM 430.00	195	FM 800.04	317
FM 312.01T	167	BM 356.00	179	BM 431.00	195	FM 800.05	317
FM 312.02T	167	BM 357.00	180	BM 432.00	195	FM 800.10	317
FM 312.04T	167	BM 357.01	180	BM 433.00	195	FM 800.11	317
FM 312.11T	167	BM 360.02	184	BM 434.00	196	FM 800.12	317
FM 312.12T	167	BM 361.02	184	BM 435.00	195	FM 800.13	317
FM 312.14T	167	BM 363.02	186	BM 438.00	197	FM 800.14	317
FM 312.21T	167	BM 370.00	183	BM 439.00	197	FM 800.15	317
FM 312.22T	167	BM 370.01	183	BM 440.00	197	FM 800.20	317
FM 312.24T	167	BM 370.02	183	BM 441.00	197	FM 800.21	317
FM 312.31T	167	BM 371.00	183	BM 442.00	197	FM 800.22	317
FM 312.32T	167	BM 371.01	183	BM 443.00	197	FM 800.23	317
FM 312.34T	167	BM 372.00	184	BM 444.00	196	FM 800.24	317
FM 166.00	165	BM 373.00	183	BM 445.00	196	FM 800.25	317
FM 083.00	204			BM 446.00	196	BM 363.02	185
FM 084.02	204			BM 400.00	192	KY 530.02	800
				BM 400.01	192	KY 529.04	801
				BM 400.02	192		

Kat. No. Cat. No.	Sayfa. Page.	Kat. No. Cat. No.	Sayfa. Page.	Kat. No. Cat. No.	Sayfa. Page.	Kat. No. Cat. No.	Sayfa. Page.
FM 800.30	317	FB 077.03	579, 752	BH 294.00	223	BH 427.00	227
FM 800.31	317	FB 078.01	578, 752	BH 295.00	223	BH 427.01	227
FM 800.32	317	FB 078.03	579, 752	BH 298.00	475	BH 427.02	227
FM 800.33	317	FB 079.01	578, 752	BH 299.00	475	BH 427.03	227
FM 800.34	317	FB 079.03	579, 752	BH 300.00	224	BH 428.00	227
FM 800.35	317	BH 200.00	218	BH 301.00	224	BH 428.01	227
BL 950.00	205	BH 201.00	218	BH 304.00	224	BH 428.02	227
BL 950.01	205	BH 202.00	219	BH 305.00	224	BH 428.03	227
BL 952.00	205	BH 204.00	218	BH 306.00	233	BH 428.04	227
BL 952.01	205	BH 205.00	218	BH 308.00	224	BH 430.00	228
BL 952.04	205	BH 206.00	218	BH 310.00	224	BH 430.01	228
BL 954.00	205	BH 207.00	218	BH 311.00	224	BH 430.02	228
BL 956.00	205	BH 210.00	218	BH 314.00	224	BH 430.03	228
BL 960.00	205	BH 211.00	218	BH 315.00	224	BH 430.04	228
BL 961.00	205	BH 212.00	218	BH 317.00	233	BH 430.10	228
BL 962.00	205	BH 214.00	218	BH 318.00	224	BH 431.00	228
BL 963.00	205	BH 215.00	218	BH 319.00	224	BH 431.01	228
BL 964.00	205	BH 218.00	218	BH 320.00	225	BH 431.02	228
		BH 219.00	218	BH 322.00	225	BH 431.03	228
		BH 220.00	219	BH 324.00	225	BH 431.04	228
MB 010.01	215	BH 221.00	219	BH 325.00	225	BH 431.10	228
BH 011.03	215	BH 226.00	219	EA 330.00	438	BH 434.00	229
BH 011.06	215	BH 227.00	219	EA 332.00	438	BH 434.01	229
FE 014.00	212	BH 228.00	219	EA 333.00	438	BH 434.02	229
FE 015.00	212	BH 229.00	219	EA 335.00	438	BH 435.00	229
FE 015.05	212	BH 230.00	219	EA 336.00	438	BH 435.01	229
FE 015.10	212	BH 231.00	219	EA 338.01	438	BH 435.02	229
FE 015.15	212	BH 233.00	219	EA 339.01	438	BH 437.00	230
FE 015.20	212	BH 234.00	219	EA 345.00	439	BH 438.00	230
FE 016.00	212	BH 235.00	219	EA 346.00	439	BH 439.00	230
FE 016.05	212	BH 237.00	220	EA 350.00	450	BH 440.00	230
FE 016.10	212	BH 238.00	220	EA 356.01	440	BH 440.01	230
FE 016.15	212	BH 239.00	220	EA 356.02	440	BH 441.00	230
FE 016.20	212	BH 240.00	220	EA 357.01	440	EA 443.01	498
BH 020.00	214	BH 241.00	220	EA 357.02	440	BH 444.00	230
BH 020.01	214	BH 244.00	220	EA 358.01	440	BH 445.00	230
BH 021.00	214	BH 245.00	220	EA 359.01	440	BH 446.00	232
BH 021.01	214	BH 250.00	220	EA 368.02	441	BH 447.00	232
BH 022.00	214	BH 251.00	220	EA 369.02	441	BH 448.00	231
BH 023.00	214	BH 254.00	220	EA 370.02	442	BH 448.01	231
BH 024.00	214	BH 255.00	220	EA 370.05	442	BH 448.02	231
BH 024.01	214	BH 260.00	221	EA 370.07	442	BH 448.03	231
BH 024.02	214	BH 261.00	221	EA 371.02	442	BH 448.04	231
BH 024.03	214	BH 262.01	221	EA 371.02	442	BH 448.05	231
BH 024.04	214	BH 262.02	221	EA 371.05	442	BH 448.07	231
BH 024.05	214	BH 262.03	221	EA 371.07	442	BH 449.00	231
BH 024.06	214	BH 262.11	221	EA 375.02	444	BH 449.01	231
BH 026.00	214	BH 262.12	221	EA 376.02	444	BH 449.02	231
BH 030.00	214	BH 262.13	221	EA 380.02	445	BH 449.03	231
BH 030.01	214	BH 264.00	221	EA 381.02	445	BH 449.04	231
FC 066.00	605	BH 265.00	221	EA 382.00	446	BH 449.05	231
FC 066.05	605	BH 268.00	221	EA 383.00	446	BH 449.07	231
FB 070.00	578, 752	BH 269.00	221	EA 385.02	445	BH 450.00	232
FB 070.01	578, 752	BH 270.00	222	EA 388.02	452	BH 450.01	232
FB 070.03	579, 752	BH 271.00	222	EA 398.00	450	BH 451.00	232
FB 071.01	578, 752	BH 273.00	223	BH 400.00	11	BH 451.01	232
FB 071.03	579, 752	BH 274.00	222	BH 401.00	226	BH 454.00	232
FB 072.00	578, 752	BH 275.00	222	BH 402.00	226	BH 455.00	232
FB 072.01	578, 752	BH 276.00	223	BH 404.01	226	BH 456.00	232, 475
FB 072.03	579, 752	BH 277.00	223	BH 408.00	226	BH 457.00	232, 475
FB 073.01	578, 752	BH 278.00	222	BH 408.01	226	BH 459.00	233, 486
FB 073.03	579, 752	BH 279.00	222	AN 410.00	11	BH 459.01	233, 486
FB 074.01	578, 752	BH 280.00	222	BH 420.00	227	BH 459.02	233, 486
FB 074.03	579, 752	BH 285.00	222	BH 420.01	227	BH 460.00	234
FB 075.01	578, 752	BH 286.00	223	BH 421.00	227	BH 460.01	234
FB 075.05	579, 752	BH 288.00	223	BH 421.01	227	BH 461.00	234
FB 076.01	578, 752	BH 289.00	223	BH 423.00	227	BH 461.01	234
FB 076.03	579, 752	BH 290.00	223	BH 423.01	227	EA 463.02	451
FB 077.01	578, 752	BH 291.00	223	BH 424.00	227	BH 464.00	234
				BH 404.00	226	BH 448.06	231
				BH 307.00	224	BH 449.06	231

Kat. No. Cat. No.	Sayfa. Page.	Kat. No. Cat. No.	Sayfa. Page.	Kat. No. Cat. No.	Sayfa. Page.	Kat. No. Cat. No.	Sayfa. Page.
BH 464.01	234	BJ 651.00	240	BJ 732.00	249	FB 131.00	215
BH 465.00	234	BJ 652.00	239	BJ 732.04	249	FB 131.01	215
BH 466.00	234	BJ 652.01	239	BJ 733.00	250	FB 134.00	217
EF 468.00	486	BJ 652.02	239	BJ 734.00	250	FB 136.00	217
EF 469.02	487	BJ 652.04	239	BJ 736.00	251	FB 136.01	217
EF 470.02	487	BJ 652.05	239	BJ 737.00	251	FB 136.02	217
EF 470.04	487	BJ 654.00	243, 475	BJ 737.04	251	FB 136.03	217
EF 470.05	487	BJ 655.00	240	BJ 740.00	250	FB 137.00	217
EF 475.02	488	BJ 656.00	241	BJ 741.00	250	FB 137.01	217
EF 476.02	488	BJ 656.01	241	BJ 750.00	252	FB 137.02	217
EF 478.02	488	BJ 656.02	241	BJ 751.00	252	FB 137.03	217
EF 480.02	448	BJ 657.00	241, 498	BJ 752.00	252	FB 138.01	217
EA 482.02	448	BJ 657.05	241	BJ 753.00	252	FB 139.00	217
EA 484.02	449	BJ 658.00	241	BJ 754.00	252	FB 140.00	217
EF 488.00	489	BJ 658.01	241	BJ 755.00	252	FB 200.00	256, 284, 451
EA 490.02	453	BJ 658.02	241	BJ 756.00	252	FB 200.01	256, 284, 451
EA 570.00	470	BJ 658.03	241	BJ 757.00	252	FB 200.02	284, 451
EA 580.00	447	BJ 658.04	241	BJ 758.00	253	FB 204.00	257, 452
EA 580.02	447	EB 660.00	244, 475	BJ 758.04	253	FB 204.01	257, 452
EA 580.04	447	EB 660.01	244, 475	BJ 758.10	253	EA 350.00	439
EA 580.06	447	BJ 664.00	243	BJ 758.11	253	EA 351.00	439
EA 585.00	450	BJ 669.00	242	BJ 760.00	254, 489	EA 354.00	439
EA 585.01	450	BJ 669.01	242	BJ 766.00	254	EA 355.00	439
EA 587.08	450	BJ 669.04	242	BJ 770.00	256, 490	EA 357.01	439
EA 587.23	450	BJ 669.05	242	BJ 771.00	490	EA 358.01	439
EA 589.00	450	BJ 669.07	242	BJ 775.00	255, 549	EA 360.02	443
BJ 609.00	218	EB 670.00	245	BJ 775.02	255, 549	EA 360.05	443
BJ 610.00	235	EB 672.00	245, 476	BJ 776.00	255, 549	EA 360.07	443
BJ 614.00	235	BJ 672.01	245, 476	BJ 776.02	255	EA 361.02	443
BJ 615.00	235	BJ 672.04	245	AN 784.00	10	EA 361.05	443
BJ 616.00	235	BJ 674.00	245	AN 784.02	10	EA 361.07	443
BJ 616.01	235	BJ 674.01	245	AN 784.03	10	EA 365.02	441
BJ 617.00	235	BJ 674.03	245	AN 784.04	10	EA 366.02	441
BJ 617.01	235	BJ 675.00	245, 547	VC 795.00	474	EA 375.03	455
BJ 618.00	236	BJ 675.02	245, 547	VC 796.00	474	EA 377.03	455
BJ 618.01	236	EB 678.00	244, 476	AN 803.00	11	EA 378.00	456
BJ 618.02	236	EB 679.00	244, 475	AN 881.00	10	EA 380.02	444
BJ 618.03	236	BJ 680.00	244	AN 883.00	11	EA 381.02	444
BJ 619.00	236	BJ 690.00	246	AN 884.00	10	EA 385.02	446
BJ 620.00	236	BJ 691.00	246	AN 884.01	10	FB 400.00	260
BJ 620.01	236	BJ 692.00	246	AN 884.02	10	FB 401.00	260
BJ 620.02	236	BJ 692.01	246	AN 885.00	10	FB 402.00	260
BJ 620.03	236	BJ 693.00	246	AN 885.01	10	FB 403.00	260
BJ 620.04	236	BJ 694.00	246			FB 406.00	260
BJ 620.05	236	BJ 695.00	246	FB 105.00	216	FB 407.00	260
BJ 620.06	236	BJ 696.00	247	FB 105.02	216	FB 408.00	260
BJ 621.00	235	BJ 697.00	247	FB 105.04	216	FB 409.00	260
BJ 621.01	235	BJ 698.00	247	FB 106.00	216	FB 410.00	260
BJ 640.00	237	BJ 700.00	251	FB 107.00	216	FB 411.00	260
BJ 640.01	237	BJ 701.00	247	FB 107.01	216	FB 412.00	260
BJ 640.02	237	BJ 701.01	247	FB 107.02	216	FB 413.00	260
BJ 640.03	237	BJ 710.00	247	FE 113.00	213	FB 420.00	271
BJ 640.04	237	BJ 718.01	248	FE 113.01	213	FB 420.01	271
BJ 640.05	237	BJ 719.01	248	FE 114.00	213	FB 420.02	271
BJ 640.06	237	BJ 720.00	247	FE 114.01	213	FB 421.00	271
BJ 640.07	237	BJ 721.00	248	FE 115.00	213	FB 421.01	271
BJ 640.08	237	BJ 722.00	248	FE 115.01	213	FB 421.02	271
BJ 640.09	237	BJ 722.01	248	FE 116.00	213	FB 422.00	269
BJ 641.00	238	BJ 722.03	248	FE 116.01	213	FB 423.00	269
BJ 641.01	238	BJ 723.00	248	FB 120.00	217	FB 430.00	270
BJ 641.02	238	BJ 723.01	248	FB 120.01	217	FB 431.00	270
BJ 641.03	238	MD 724.00	249	FB 120.02	217	FB 432.00	270
BJ 641.04	238	MD 724.10	249	FB 120.03	217	FB 433.00	270
BJ 644.00	238	BJ 726.00	251	FB 121.00	217	FB 434.00	270
BJ 644.02	238	BJ 727.00	251	FB 121.01	217	FB 435.03	282
BJ 644.03	238	BJ 727.10	251	FB 121.02	217	FB 435.04	282
BJ 644.04	238	BJ 729.00	249	FB 121.03	217	FB 440.00	282
BJ 644.05	238	BJ 730.00	249	FB 130.00	215	FB 440.01	282
BJ 650.00	240	BJ 730.01	249	FB 130.01	215	FB 442.00	282
BH 308.00	240						

Kat. No. Cat. No.	Sayfa. Page.	Kat. No. Cat. No.	Sayfa. Page.	Kat. No. Cat. No.	Sayfa. Page.	Kat. No. Cat. No.	Sayfa. Page.
FB 442.01	282	FB 564.00	267	FB 655.00	294	BN 042.00	302
FB 444.00	281	FB 564.01	267	FB 656.00	294	BN 043.00	302
FB 445.00	282	FB 566.00	267	FB 679.00	276	BN 044.03	302
FB 446.00	283	FB 567.00	267	FB 679.01	276	BN 044.05	302
FB 447.00	283	FB 568.00	267	FB 755.00	296	BN 044.10	302
FB 448.00	277	FB 569.00	267	FB 756.00	296	OM 045.00	302
FB 448.01	277	FB 570.00	268	FB 757.00	297	BN 047.00	302
FB 448.02	277	FB 570.01	268	FB 758.00	295	OB 049.00	302
FB 449.00	283	FB 570.02	268	FB 758.01	295	OB 049.01	302
FB 450.00	269	FB 570.03	268	FB 759.00	295	OB 049.02	302
FB 451.00	269	FB 570.04	268	FB 759.01	295	OB 049.03	302
FB 451.01	269	FB 571.00	268	FB 759.02	295	OB 049.04	302
FB 452.00	266	FB 571.01	268	FC 770.00	285	BN 050.00	302
FB 452.01	266	FB 571.02	268	FC 770.01	285	BN 051.00	303
FB 453.00	266	FB 572.00	281	FC 771.00	285	BN 052.01	303
FB 454.00	266	FB 573.00	281	FC 771.01	285	BN 052.02	303
FB 455.00	266	FB 576.00	278	FC 772.00	285	BN 052.05	303
FB 460.00	273, 454	FB 577.00	278	FC 772.01	285	BN 052.06	303
FB 461.00	273, 454	FB 580.00	272	FC 773.00	285	OF 053.00	304
FB 465.00	276	FB 580.01	272	FC 773.01	285	OF 053.01	304
FB 465.01	276	FB 580.02	272	FC 774.00	285	OF 055.00	304
FB 465.02	276	FB 580.03	272	FC 774.01	285	BN 055.01	303
FB 466.00	276	FB 581.00	272			BN 055.02	303
FB 477.00	274	FB 581.01	272			OF 056.00	304
FB 477.01	274	FB 581.02	272	BN 010.00	300	BN 056.01	303
FB 477.02	274	FB 581.03	272	BN 010.01	300	BN 056.02	303
FB 478.00	274	FB 600.00	286	BN 010.02	300	BN 059.00	303
FB 480.00	275	FB 601.00	286	BN 012.00	300	OM 065.00	304
FB 481.00	275	FB 602.00	286	BN 013.00	300	EB 070.05	478
FB 484.00	279	FB 604.00	286	BN 015.00	300	EB 071.00	478
FB 485.00	279	FB 605.00	286	BN 018.00	300, 472	FD 075.00	754
FB 486.00	280	FB 606.00	286	BN 020.00	300, 472	FD 075.01	754
FB 486.01	280	FB 607.00	286	BN 020.01	300, 472	FD 075.02	754
FB 487.00	280	FB 608.00	287	BN 020.02	300, 472	FD 076.00	755
FB 488.00	277	FB 609.00	287	BN 020.03	300, 472	FD 076.01	755
FB 489.00	277	FB 611.00	287	BN 024.00	300, 472	EB 077.03	478
EF 495.00	500	FB 612.00	287	BN 030.00	301	EB 077.06	478
FB 500.00	271	FB 613.00	287	BN 030.01	301	EB 077.09	478
FB 501.00	271	MB 615.00	287	BN 030.02	301	EF 080.08	408, 504
FB 502.00	271	FB 620.00	288	BN 030.03	301	EF 080.09	408, 504
FB 510.00	261	FB 620.01	288	BN 030.04	301	EF 080.10	408, 504
FB 510.01	261	FB 621.01	288	BN 032.01	306	EF 080.11	408, 504
FB 510.02	261	FB 621.02	288	BN 032.02	306, 308	EF 080.12	408, 504
FB 511.00	261	FB 630.00	289	BN 032.04	306, 308	EF 080.13	408, 504
FB 511.02	261	FB 630.01	289	BN 032.06	306, 308	EF 080.14	408, 504
FB 520.00	262	FB 630.02	289	BN 032.08	306	EF 080.15	408, 504
FB 521.00	262	FB 631.00	290	BN 033.01	301	EF 080.16	408, 504
FB 522.00	262	FB 631.01	290	BN 033.07	301	EF 080.17	408, 504
FB 523.00	262	FB 631.02	290	BN 033.08	301	EF 080.18	408, 504
FB 524.00	262	FB 631.03	290	BN 033.09	301	EF 080.19	408, 504
FB 525.00	262	FB 634.00	292	BN 033.10	301	EF 080.20	408, 504
FB 530.00	263	FB 634.01	292	BN 033.11	301	EF 080.21	408, 504
FB 531.00	263	FB 635.00	292	BN 033.12	301	EF 080.22	408, 504
FB 532.00	263	FB 636.00	292	BN 033.15	301	EF 080.23	408, 504
FB 533.00	263	FB 638.00	292	BN 033.16	301	EF 080.24	408, 504
FB 540.00	263	FB 640.00	289	BN 033.17	301	EF 080.25	408, 504
FB 540.01	263	FB 641.00	289	BN 033.18	301	EF 080.26	408, 504
FB 540.02	263	FB 642.00	289	BN 033.20	301	EF 080.27	408, 504
FB 540.03	263	FB 643.00	291	BN 034.00	301, 827	EF 080.28	408, 504
FB 545.00	264	FB 644.00	291	BN 035.00	301, 827	EF 080.29	408, 504
FB 545.01	264	FB 645.00	293	BN 035.01	301, 827	EF 080.30	408, 504
FB 550.00	264	FB 645.01	293	BN 035.02	301, 827	EB 082.03	481
FB 551.00	264	FB 645.02	293	BN 036.00	304	EB 082.04	481
FB 552.00	264	FB 645.03	293	BN 037.00	301, 472	EB 082.05	481
FB 554.00	265	FB 645.04	293	BN 038.00	301	EB 082.06	481
FB 554.01	265	FB 653.00	294	BN 038.01	834	EB 082.07	481
FB 554.02	265	FB 653.01	294	BN 039.00	301	EB 082.08	481
FB 556.00	265	FB 654.00	294	BN 039.10	301	EB 082.09	481
FB 562.00	265	FB 654.01	294	BN 040.01	301	EB 082.10	481
FB 511.00	261	FB 647.00	293	BN 031.00	301	EB 085.00	567
						EF 090.03	502
						EF 090.04	502
						EF 090.05	502
						EF 090.06	502
						EF 092.24	505
						EF 092.25	505
						EF 092.26	505
						EF 092.27	505
						EF 092.28	505
						EF 092.29	505
						EF 092.30	505
						EF 092.31	505

Kat. No. Cat. No.	Sayfa. Page.	Kat. No. Cat. No.	Sayfa. Page.	Kat. No. Cat. No.	Sayfa. Page.	Kat. No. Cat. No.	Sayfa. Page.
EF 092.32	505	GF 213.01	309	GF 228.49	309	GF 406.00	313
EF 092.33	505	GF 213.02	309	GF 228.60	309	GF 415.00	313
EF 092.34	505	GF 213.03	309	GF 228.61	309	GF 418.00	313
EF 092.35	505	GF 213.05	309	GF 228.62	309	GF 422.01	312
EF 092.36	505	GF 213.06	309	GF 228.63	309	GF 422.02	312
EF 092.37	505	GF 213.07	309	GF 228.64	309	GF 422.03	312
EF 092.38	505	GF 213.08	309	GF 228.65	309	GF 423.00	312
EF 092.39	505	GF 213.10	309	GF 228.66	309	GF 432.00	313
EF 092.40	505	GF 213.11	309	GF 228.69	309	GF 436.00	313
EF 092.41	505	GF 213.12	309	GF 229.00	309	GF 437.00	313
EF 092.42	505	GF 213.13	309	GF 229.02	309	GF 451.00	315, 561
EF 092.43	505	GF 215.01	305	SK 232.00	306	GF 451.01	315, 561
EF 092.44	505	GF 215.02	305	OG 236.00	307	GF 451.02	315, 561
EF 092.45	505	GF 215.03	305	OG 236.01	307	GF 451.03	315, 561
EF 092.46	505	GF 215.04	305	OG 236.02	307	GF 451.04	315, 561
EF 092.47	505	GF 215.06	305	OG 236.03	307	GF 451.05	315, 561
EF 092.48	505	GF 215.08	305	OG 236.04	307	GF 458.00	315, 561
EF 092.49	505	GF 215.21	305	OG 236.10	307	GF 459.00	315, 561
EF 092.50	505	GF 215.22	305	OG 238.00	307	GF 461.01	306
EF 092.51	505	GF 215.23	305	OG 238.01	307	GF 480.03	561
EF 092.52	505	GF 215.24	305	OG 238.02	307	GF 480.04	561
EF 092.53	505	GF 215.26	305	OG 238.03	307	GF 480.05	561
EF 092.54	505	GF 215.28	305	OG 238.10	307	GF 480.10	561
EF 092.55	505	GF 215.51	305	FD 260.00	312	ER 490.00	562
EF 092.56	505	GF 215.52	305	FD 260.01	312	ER 490.01	562
EF 092.57	505	GF 215.53	305	FD 260.02	312	ER 490.02	562
EF 092.58	505	GF 215.54	305	FD 260.03	312	ER 490.03	562
EF 092.59	505	GF 215.56	305	FD 260.04	312	ER 490.04	562
EF 092.60	505	GF 215.58	305	FD 260.05	312	ER 492.00	562
EF 093.00	505	GF 215.81	305	FD 260.06	312	ER 493.00	563
EF 094.08	503	GF 215.82	305	FD 260.07	312	ER 495.00	563
EF 094.10	503	GF 215.83	305	FD 260.08	312	ER 496.00	562
EF 094.12	503	GF 215.84	305	FD 260.09	312	ER 496.01	562
EF 094.14	503	GF 215.86	305	FD 260.10	312	ER 496.02	562
EF 094.16	503	GF 215.88	305	FD 260.11	312	ER 497.00	563
EF 094.18	503	GF 219.00	306	FD 260.12	312	FB 500.00	599
EF 094.20	503	GF 220.02	305	FD 260.13	312	FB 500.01	599
EF 095.06	503	GF 221.00	305	FD 260.14	312	FB 500.03	599
EF 095.07	503	GF 221.01	305	FD 260.15	312	FB 500.04	599
EF 095.08	503	GF 221.02	305	OP 263.00	312	FB 500.05	599
EF 095.09	503	GF 221.03	305	OP 263.01	312	FB 500.06	599
EF 095.10	503	GF 222.00	305	OP 265.00	310	FB 500.07	599
EF 095.11	503	GF 222.01	305	OP 265.01	310	FB 500.08	599
EF 095.12	503	GF 224.01	307	OP 265.02	310	FB 500.10	599
EF 095.13	503	GF 224.02	307	OM300.00	314	FB 500.11	599
EF 095.14	503	GF 225.01	307	GF 301.00	314, 607	FB 500.12	599
EF 095.15	503	GF 227.01	307	GF 304.00	314, 607	FB 502.00	599
EF 095.16	503	GF 228.00	309	GF 306.00	314, 607	FB 502.01	599
EF 095.18	503	GF 228.01	309	GF 308.00	314, 607	FB 502.03	599
EF 095.20	503	GF 228.02	309	GF 308.01	301	FB 502.04	599
EF 097.10	504	GF 228.03	309	GF 352.00	311	FB 502.05	599
EF 098.02	504	GF 228.04	309	OF 354.00	308	FB 510.02	600
EF 099.02	504	GF 228.05	309	OF 355.00	308	FB 510.03	600
EJ 102.00	316	GF 228.09	309	OF 355.01	308	FB 510.04	600
EJ 108.00	316	GF 228.20	309	OK 357.01	478	FB 510.05	600
EJ 110.00	316	GF 228.21	309	OL 360.00	310	FB 510.06	600
EJ 130.00	316	GF 228.22	309	OL 360.01	310	FB 510.07	600
EJ 130.01	316	GF 228.23	309	OL 361.00	310	FB 510.08	600
EJ 130.02	316	GF 228.24	309	OM365.00	311	FB 510.09	600
EJ 130.03	316	GF 228.25	309	OM367.00	311	FB 510.10	600
EJ 132.00	316	GF 228.26	309	OL 368.00	311	FB 510.11	600
EJ 132.01	316	GF 228.29	309	GF 370.00	308	FB 510.12	600
EJ 133.00	564	GF 228.40	309	GF 370.06	308	FB 510.13	600
EJ 134.00	564	GF 228.41	309	GF 375.01	478	FB 510.14	600
EJ 138.00	316	GF 228.42	309	GF 375.02	308	FB 510.15	600
GF 212.00	306	GF 228.43	309	GF 377.00	308	FB 510.17	600
GF 212.01	306	GF 228.44	309	GF 377.01	308	FB 511.02	600
GF 212.03	306	GF 228.45	309	GF 378.00	308	FB 511.03	600
GF 213.00	309	GF 228.46	309	GF 400.00	313	FB 511.04	600
GF 212.02	306	GF 228.06	309	GF 260.12	312		

Kat. No. Cat. No.	Sayfa. Page.	Kat. No. Cat. No.	Sayfa. Page.	Kat. No. Cat. No.	Sayfa. Page.	Kat. No. Cat. No.	Sayfa. Page.
FB 511.05	600	FB 520.04	603	EM 751.07	526	OA 125.00	322
FB 511.06	600	FB 525.01	603	EM 751.08	526	OL 127.00	322, 840
FB 511.07	600	FB 525.02	603	EM 751.09	526	OL 128.00	322
FB 511.08	600	FB 525.03	603	EM 751.10	526	OL 130.00	322
FB 511.09	600	FB 525.04	603	EM 751.11	526	OL 131.00	322
EB 512.01	480	FB 525.05	603	EM 751.12	526	OL 133.00	322
EB 512.02	480	FB 525.06	603	EM 751.13	526	OL 134.00	323
EB 512.03	480	FB 525.07	603	EM 751.14	526	OA 136.00	323
EB 512.04	480	FB 525.08	603	EM 751.15	526	FF 137.00	323
EB 512.05	480	FB 525.09	603	EM 751.16	526	OL 138.00	323
EB 512.06	480	FB 525.12	603	EM 751.17	526	OL 138.01	323
EB 512.07	480	FB 530.01	602	EM 754.01	526	FD 140.00	323, 757
EB 512.08	480	FB 530.02	602	EM 754.02	526	FD 142.00	324, 757
EB 512.09	480	FB 530.05	602	EM 754.03	526	OL 143.00	323
EB 512.10	480	FB 530.06	602	EM 754.04	526	OL 143.01	323
EB 512.11	480	GF 600.00	315, 607	EM 754.05	526	OL 143.02	323
EB 512.12	480	GF 602.00	311	EM 754.06	526	OL 143.03	323
EB 512.13	480	GF 604.00	310	EM 754.07	526	OL 143.04	323
MB 513.00	601	GF 608.00	310	EM 754.08	526	OL 144.00	320
MB 513.01	601	GF 608.01	310	EM 754.09	526	OL 144.10	320
MB 513.02	601	GF 608.02	310	EM 756.01	526	FD 145.00	324, 757
MB 513.03	601	GK 620.00	315, 863	EM 756.02	526	OL 148.00	324
MB 513.04	601	EO 650.05	478, 530	EM 756.03	526	OL 148.01	324
MB 513.05	601	EO 652.05	530	EM 756.04	526	OL 149.00	324
MB 513.06	601	EO 652.08	530	EM 756.05	526	OL 150.00	324
MB 513.07	601	EO 653.05	530	EM 756.06	526	OL 151.00	324
MB 513.08	601	EO 654.00	531	EM 756.07	526	OF 156.00	320
MB 513.09	601	EO 656.05	530	EM 756.08	526	FA 158.00	323
MB 513.11	601	EO 658.05	531	EM 790.00	527	FA 158.01	323
MB 513.13	601	EJ 706.00	316	EM 790.01	527	FA 158.02	323
MB 514.00	601	SR 710.00	606	EM 792.00	527	FA 160.00	325
MB 514.01	601	SR 710.02	606			FA 161.00	325
MB 514.02	601	SF 729.01	306			BT 163.00	325
MB 514.03	601	SF 729.02	306	OF 100.00	320	BT 164.00	325
MB 514.04	601	SF 729.04	306	OF 100.01	320	BT 165.00	325
MB 514.05	601	SF 729.06	306	OF 100.02	320	BT 165.01	325
MB 514.06	601	SF 729.08	306	OF 100.03	320	BT 166.00	325
MB 514.07	601	EM 750.01	526	OF 102.00	320	BT 166.01	325
MB 514.08	601	EM 750.02	526	OF 102.01	320	BT 166.02	325
MB 514.09	601	EM 750.03	526	OF 102.02	320	BT 167.00	325
MB 514.11	601	EM 750.04	526	BT 103.00	320	BT 167.01	325
MB 514.13	601	EM 750.05	526	BT 104.00	320	BT 167.02	325
MB 515.00	601	EM 750.06	526	BT 104.01	320	BT 168.00	326
MB 515.01	601	EM 750.07	526	BT 106.00	320	BT 168.01	326
MB 515.02	601	EM 750.08	526	BT 108.00	320	BT 168.02	326
MB 515.03	601	EM 750.09	526	FD 110.00	321, 756	BT 168.03	326
MB 515.04	601	EM 750.10	526	FD 110.01	321, 756	BT 169.00	326
MB 515.05	601	EM 750.11	526	FD 110.02	321, 756	BT 169.01	326
MB 515.06	601	EM 750.12	526	FD 110.03	321, 756	BT 169.02	326
MB 515.07	601	EM 750.13	526	FD 111.00	756	BT 169.03	326
MB 515.08	601	EM 750.14	526	FD 111.01	756	BT 170.00	326
MB 515.09	601	EM 750.15	526	FD 111.02	756	BT 170.01	326
MB 515.11	601	EM 750.16	526	FD 111.03	756	BT 170.02	326
MB 515.13	601	EM 750.17	526	BT 112.00	321, 757	BT 170.03	326
MB 516.00	601	EM 750.18	526	BT 112.01	321, 757	BT 171.00	326, 500
MB 516.01	601	EM 750.19	526	BT 112.02	321, 757	BT 171.01	326
MB 516.02	601	EM 750.20	526	BT 112.03	321, 757	BT 171.02	326
MB 516.03	601	EM 750.21	526	FD 113.00	762	BT 171.03	326
MB 516.04	601	EM 750.22	526	FD 114.00	762	BT 175.00	327
MB 516.05	601	EM 750.23	526	FF 115.00	783	BT 176.00	327
MB 516.06	601	EM 750.24	526	FF 116.00	781	BT 177.00	327
MB 516.07	601	EM 750.25	526	FF 117.00	322	BT 178.00	327
MB 516.08	601	EM 750.26	526	OA 120.00	322	BT 180.00	327
MB 516.09	601	EM 751.01	526	OA 121.00	322	BT 180.01	327
MB 516.11	601	EM 751.02	526	FF 122.00	322	BT 180.02	327
MB 516.13	601	EM 751.03	526	OA 123.00	322	BT 181.00	327
FB 520.01	603	EM 751.04	526	OA 123.01	322	BT 181.01	327
FB 520.02	603	EM 751.05	526	OA 124.00	322	BT 181.02	327
FB 520.03	603	EM 751.06	526	OA 124.01	322	BT 182.00	327
				EM 952.00	562		

Kat. No. Cat. No.	Sayfa. Page.	Kat. No. Cat. No.	Sayfa. Page.	Kat. No. Cat. No.	Sayfa. Page.	Kat. No. Cat. No.	Sayfa. Page.
BT 182.01	327	BT 276.00	333	BT 431.03	341	BT 458.02	347
BT 182.02	327	BT 276.01	333	BT 432.00	341	BT 458.03	347
BT 183.00	327	FF 280.01	334	FF 432.01	341	FF 458.04	347
BT 183.01	327	FF 280.02	334	FF 432.02	341	FF 458.05	347
BT 183.02	327	FF 280.03	334	FF 432.03	341	FF 460.00	348
BT 190.00	328	FF 283.01	334	FF 432.04	341	FF 460.01	348
BT 191.00	328	FF 284.00	334	FF 433.00	341	FF 460.02	348
BT 191.01	328	FF 284.01	334	FF 433.01	341	FF 460.03	348
BT 191.02	328	FF 284.02	334	FF 433.02	341	FF 460.04	348
BT 191.03	328	FF 284.03	334	FF 433.03	341	FF 461.00	348
BT 193.00	328	FF 288.00	334	FF 433.04	341	FF 461.01	348
BT 193.01	328	FF 288.01	334	FF 434.00	341	FF 461.02	348
BT 195.00	328	FF 288.02	334	FF 434.01	341	FF 463.02	349
BT 195.02	328	FF 289.01	334	FF 434.02	341	FF 464.02	349
BT 196.00	328	FF 293.01	334	FF 434.03	341	FF 466.00	349
BT 198.00	328	ET 295.02	565	ET 434.04	341	ET 466.01	349
BT 200.00	329	BT 300.00	335	BT 435.00	342	BT 470.00	350, 819
BT 200.01	329	BT 301.00	335	BT 435.01	342	BT 470.01	350, 819
BT 202.00	329	BT 302.00	335	BT 435.02	342	BT 470.02	350, 819
BT 202.01	329	BT 304.00	335	BT 435.03	342	BT 470.03	350, 819
BT 203.00	329	BT 310.00	335	BT 436.00	342	BT 470.04	350, 819
BT 205.00	329	BT 311.00	335	BT 436.01	342	BT 475.00	350, 819
BT 206.00	329	BT 312.00	335	BT 436.02	342	BT 477.00	350, 819
OL 210.00	329	BT 314.00	336	BT 436.03	342	BT 479.00	351, 819
OL 212.00	329	BT 315.00	336	BT 437.00	342	BT 480.00	352
BT 220.00	330	BT 317.00	336	BT 438.00	342	BT 480.01	352
BT 221.00	330	BT 320.00	336	BT 439.00	342	BT 480.02	352
BT 223.00	330	BT 320.01	336	BT 440.00	343	BT 481.00	352
OL 225.00	330	BT 320.02	336	BT 442.00	343	BT 482.00	352
OL 227.00	472	BT 322.01	337	BT 444.00	343	BT 483.00	351
BT 230.00	332	BT 325.00	337	BT 444.01	343	BT 490.00	353
BT 230.01	332	BT 325.01	337	BT 444.02	343	BT 490.01	353
BT 230.02	332	BT 325.02	337	BT 444.03	343	BT 490.02	353
BT 230.03	332	BT 325.03	337	BT 448.00	344	BT 491.00	353
BT 230.04	332	BT 327.00	338	BT 448.01	344	BT 492.00	353
BT 230.05	332	BT 327.01	338	BT 448.10	344	BT 492.01	353
BT 237.00	332	BT 328.00	338	BT 448.11	344	BT 492.02	353
DO 238.00	332	BT 328.01	338	BT 449.00	351	BT 492.05	353
DO 238.01	332	MD 332.00	337	MD 450.01	344	MD 493.00	354
DO 238.02	332	MD 333.00	337	MD 450.02	344	MD 494.00	354
BT 240.00	332	BT 335.00	648	BT 450.03	344	BT 494.01	354
BT 241.00	332	BT 335.01	648	BT 451.01	344	BT 494.02	354
BT 242.00	332	BT 335.02	648	BT 451.02	344	BT 500.00	753
OA 244.00	333	BT 337.01	338	BT 451.03	344	BT 500.01	753
BT 246.00	333	BT 339.01	338	BT 451.04	344	BT 501.00	753
BT 246.01	333	BT 339.02	338	BT 451.05	344	BT 502.00	753
BT 248.00	333	BT 339.03	338	BT 451.06	344	BT 504.00	753
BT 259.00	331	BT 340.00	339	BT 452.01	345	BT 505.00	774
OL 260.00	330	BT 341.00	339	BT 452.03	345	BT 506.00	774
OL 261.00	330	BT 342.00	339	BT 452.04	345	BT 552.00	788
OA 262.00	330	OM 346.00	339	OM 452.05	345	OM 552.01	788
OA 262.01	330	OM 346.01	339	OM 452.06	345	OM 552.02	788
OA 262.02	330	OM 346.02	339	OM 452.07	345	OM 554.00	788
OA 262.03	330	BT 348.00	339	BT 452.08	345	BT 555.00	788
OA 262.04	330	EO 390.03	531	EO 452.09	345	EO 557.00	788
BT 263.00	331	BT 400.00	340	BT 452.10	345	BT 559.00	751
BT 266.00	331	BT 402.00	340	BT 453.00	346	BT 559.01	751
BT 267.00	331	BT 403.00	340	BT 454.00	346	BT 559.02	751
BT 267.01	331	BT 404.00	340	BT 454.01	346	BT 559.03	751
BT 268.00	333	BT 405.00	340	BT 455.00	346	BT 559.04	751
BT 268.01	333	BT 408.00	340	BT 456.00	346	BT 560.01	750
BT 268.02	333	BT 410.00	340	BT 457.00	347	BT 560.02	750
BT 268.03	333	BT 430.00	341	BT 457.01	347	BT 560.03	750
OK 270.00	331	BT 430.01	341	BT 457.02	347	BT 560.04	750
BT 272.00	331	BT 430.02	341	BT 457.03	347	BT 560.05	750
BT 274.00	331	BT 430.03	341	BT 457.04	347	BT 560.06	750
BT 274.01	331	BT 431.00	341	BT 457.05	347	BT 561.01	750
BT 274.02	331	BT 431.01	341	BT 458.00	347	BT 561.02	750
BT 195.01	328	BT 431.02	341	BT 458.01	347	BT 561.03	750

Kat. No. Cat. No.	Sayfa. Page.	Kat. No. Cat. No.	Sayfa. Page.	Kat. No. Cat. No.	Sayfa. Page.	Kat. No. Cat. No.	Sayfa. Page.
FF 562.01	750	BT 631.00	364	FB 697.02P	593	BT 739.00	488
FF 562.02	750	BT 635.02	365	BT 700.01	378	BT 739.01	388
FF 564.01	750	BT 637.01	366	BT 700.02	378	BT 739.02	388
FF 564.02	750	BT 637.03	366	BT 700.03	378	BT 739.03	388
FF 564.03	750	BT 640.00	365	BT 700.04	378	BT 739.04	388
FF 564.04	750	BT 642.00	367	BT 701.00	379	BT 740.00	389
FF 565.01	750	BT 642.01	367	BT 702.02	379	BT 742.00	389
FF 565.02	750	BT 642.02	367	BT 702.03	379	BT 752.00	390, 750
FF 565.03	750	BT 642.03	367	EL 705.01	380, 519	BT 752.01	390
FF 565.04	750	BT 642.04	367	EL 705.02	380, 519	BT 752.02	390
FF 570.01	750	BT 642.05	368	EL 705.03	380, 519	BT 754.00	390
FF 570.02	750	BT 644.00	368	EL 705.04	380, 519	BT 756.00	391
FF 570.03	750	BT 644.01	368	EL 705.05	380, 519	BT 756.01	391
FF 570.04	750	BT 644.02	368	EL 705.06	380, 519	BT 756.02	391
FF 571.00	750	BT 644.03	368	EL 705.07	380, 519	BT 756.04	391
FF 571.01	750	BT 644.04	368	EL 705.08	380, 519	BT 758.00	390
FF 571.02	750	BT 644.05	368	EL 705.09	380, 519	BT 758.01	390
FF 571.03	750	BT 644.06	368	EL 705.12	380, 519	BT 758.02	390
FF 571.05	750	BT 660.01	369	EL 705.14	380, 519	BT 758.03	390
OM580.00	1, 2, 4	BT 660.02	369	EL 706.01	522	BT 758.04	390
OM580.01	2	BT 660.03	369	EL 706.02	522	BT 760.00	391
OM581.00	2	BT 660.04	370	EL 706.03	522	BT 764.00	391
OM583.00	2	BT 660.05	370	BT 707.00	381	BT 765.00	497
OM585.00	2	BT 660.06	371	BT 709.00	382	BT 766.00	391
BT 600.00	355	BT 660.07	371	BT 710.00	382	BT 767.00	497
BT 601.00	355	BT 660.08	372	BT 711.00	381	EL 804.01	512
DO 602.00	355	BT 660.09	372	BT 715.01	383	EL 804.02	512
DO 602.01	355	MD 661.00	369	BT 715.02	383	EL 804.03	512
DO 604.00	355	MD 661.01	369	BT 715.03	383	EL 806.01	512
BT 605.01	356	BT 668.04	373	BT 715.04	383	EL 807.01	512
BT 605.02	356	BT 668.05	373	BT 715.05	383	EL 807.02	512
BT 605.04	356	BT 668.07	374	BV 722.00	495	EL 807.03	512
BT 605.05	356	BT 668.08	374	BV 723.00	495, 430	EL 809.02	512
BT 605.06	356	BT 670.00	375	BT 725.00	384, 461	EL 809.03	512
BT 606.00	356	BT 670.02	375	BT 725.02	384, 461	EL 809.04	512
BT 606.01	356	BT 672.00	376	BT 725.04	384, 461	EL 809.05	512
BT 606.02	356	BT 676.02	390	BT 726.00	377, 497	EL 809.06	512
BT 607.00	357	BT 678.02	376	BT 726.01	385, 497	EL 812.00	513
BT 607.01	357	EL 680.02	520	BT 726.02	385	EL 812.01	513
BT 607.02	357	EL 680.04	520	BT 727.00	377	EL 812.02	513
BT 608.00	358	EL 682.02	520	BT 728.00	386	EL 812.03	513
BT 608.01	358	EL 682.03	520	BT 728.02	386	EL 812.04	514
BT 608.02	358	EL 682.04	520	BT 730.00	387	EL 812.05	514
BT 608.03	358	EL 682.05	520	BT 730.01	387	EL 812.06	514
BT 609.00	359	EL 682.06	520	BT 731.00	387	EL 812.07	514
BT 609.01	359	EL 683.02	520	BT 731.10	387	EL 812.08	514
BT 609.02	359	EL 683.03	520	BT 732.00	388	EL 814.00	513
BT 609.03	359	EL 683.04	520	BT 732.01	388	EL 814.01	513
BT 609.04	359	EL 683.05	520	BT 732.02	388	EL 814.02	513
BT 609.05	359	EL 683.06	520	BT 732.03	388	EL 814.03	513
BT 609.06	359	EL 684.02	520	EL 735.01	524	EL 814.04	514
BT 609.10	460	EL 684.03	520	EL 735.08	524	EL 814.05	514
EL 610.01	360, 521	FB 694.00	595	EL 735.09	524	EL 814.06	514
EL 612.01	360, 521	FB 694.01	595	EL 735.10	524	EL 814.07	514
EL 614.01	360, 521	FB 694.02	595	EL 735.11	524	EL 814.08	514
EL 614.02	360, 521	FB 694.03	595	EL 735.12	524	BT 815.00	518
BT 616.00	361	FB 694.04	595	EL 735.15	524	EL 817.02	515
BT 616.02	361	FB 694.05	595	EL 735.16	524	EL 817.03	515
BT 616.04	361	FB 695.00	594	EL 735.20	524	EL 817.04	515
BT 616.06	361	FB 695.00P	592	EL 735.21	524	BT 818.00	518
BT 620.00	362	FB 695.01	594	EL 735.22	524	EL 819.02	515
BT 620.01	362	FB 695.01P	592	EL 735.23	524	EL 819.03	515
BT 621.00	362	FB 695.02	594	EL 735.24	524	EL 819.04	515
BT 625.02	363	FB 695.02P	592	EL 735.25	524	EL 825.01	516
BT 625.05	363	FB 696.00	594	EL 735.26	524	EL 826.01	516
BT 628.02	363	FB 696.01	594	EL 735.27	524	EL 830.01	516
BT 630.00	364	FB 696.02	594	EL 735.30	524	EL 830.05	516
BT 630.01	364	FB 696.02P	593	EL 736.00	388	EL 832.01	516
BT 630.02	364	FB 697.02	594	EL 737.00	388	EL 832.05	516
		BT 676.04	390			BT 752.02	750

Kat. No. Cat. No.	Sayfa. Page.	Kat. No. Cat. No.	Sayfa. Page.	Kat. No. Cat. No.	Sayfa. Page.	Kat. No. Cat. No.	Sayfa. Page.
EL 832.08	516	BV 306.00	396	MF 394.00	407	BV 463.31	413
EL 841.00	517	BV 308.00	397	BV 402.00	401	BV 463.32	413
EL 841.01	517	BV 309.00	397	BV 402.03	401	BV 463.33	413
EL 841.02	517	BV 312.00	397	BV 402.05	401	BV 463.34	413
EL 841.03	517	BV 313.00	397	BV 403.00	430	BV 463.35	413
EL 841.04	517	BV 314.00	397	BV 403.03	430	BV 463.36	413
EL 841.05	517	BV 318.00	397	BV 403.06	430	BV 463.37	414
EL 841.06	517	OK 320.00	398	BV 405.00	408	BV 463.50	414
EL 841.07	517	OK 321.00	398	BV 406.00	408	BV 463.50T	790
EL 841.08	517	BV 325.00	398	BV 408.00	408, 525	BV 463.52	414
EL 843.01	518	BV 326.00	398	BV 409.00	408, 525	BV 463.52T	790
EL 844.01	518	BV 327.00	398	BV 412.00	408, 525	BV 463.60	414
EL 850.01	518	BV 328.00	398	BV 415.00	408	BV 463.61	414
EL 851.01	518	BV 329.00	399	BV 417.00	409, 525	BV 463.63	414
EL 854.00	518	BV 330.02	399	BV 419.00	409	BV 463.64	414
EL 856.01	522	BV 330.04	399	BV 437.00	395	BV 463.65	414
EL 857.01	522	BV 330.06	399	BV 440.01	414	BV 463.66	414
EL 862.01	523	BV 330.15	401	BV 440.02	414	BV 463.67	414
EL 863.01	523	BV 331.02	399	BV 440.03	414	BV 463.70	414
EL 863.02	523	BV 331.04	399	BV 440.04	414	BV 463.71	414
EL 864.00	523	BV 331.06	399	BV 450.00	411	BV 463.72	414
EL 868.01	523	BV 335.00	399	BV 450.01	411	BV 463.73	414
EL 868.02	523	BV 336.00	399	BV 450.04	411	BV 463.74	414
EL 868.03	523	BV 338.00	400	BV 450.06	411	BV 463.75	414
		BV 339.00	400	BV 450.08	411	BV 463.76	414
		BV 340.00	400	BV 450.10	411	BV 463.80	414
BV 004.00	845	BV 345.00	400	BV 450.14	411	BV 463.81	414
BV 005.00	394	BV 347.00	400	BV 450.15	411	BV 463.82	414
BV 005.01	394	BV 348.00	400	BV 450.16	411	BV 463.83	414
BV 006.00	394	BV 350.00	401	BV 450.18	411	BV 463.84	414
FA 009.00	394	BV 351.00	401	BV 450.20	411	BV 463.85	414
OA 013.02	394	BV 352.00	401	BV 452.00	411	BV 463.86	414
OA 025.00	394	BV 353.01	402	BV 452.01	411	BV 463.87	414
OA 027.00	394	BV 353.02	402	BV 452.04	411	BV 465.00	416
BV 052.00	394	BV 353.03	402	BV 452.06	411	BV 465.01	416
BV 080.00	394	BV 354.01	402	BV 452.08	411	BV 465.05	791
BV 081.00	394	BV 354.02	402	BV 452.10	411	BV 467.00	416
BV 082.00	395, 845	BV 354.03	402	BV 452.12	411	BV 467.01	416
BV 083.00	395	BV 355.01	402	BV 455.00	412	BV 467.05	791
BV 085.00	395	BV 355.02	402	BV 455.01	411	BV 469.00	416
BV 085.01	395	BV 355.03	402	BV 455.05	412	BV 469.01	416
BV 088.00	395	BV 360.00	403	BV 455.06	412	BV 469.05	791
BV 088.01	395	BV 362.00	403	BV 455.19	412	BV 470.00	416
BV 089.00	395	BV 364.00	403	BV 455.40	412	BV 470.01	416
BV 093.00	395	BV 366.02	404	BV 455.45	412	BV 470.02	416
BV 095.00	395	BV 370.02	404	BV 455.51	412	BV 470.03	416
BV 097.00	395	BV 371.02	404	BV 455.61	412	BV 470.04	416
OM 199.00	3	BV 373.02	405	BV 460.00	413	BV 470.06	416
OM 200.00	3	BV 375.02	405	BV 460.01	413	BV 470.07	416
OM 201.00	3	BV 377.02	405	BV 461.00	414	BV 470.08	416
OM 202.00	3	MF 380.00	406	BV 461.01	414	BV 470.09	416
OM 203.00	3	MF 380.01	406	BV 463.00	413	BV 470.10	416
OM 206.00	3	MF 380.02	406	BV 463.02	413	BV 470.20T	790
FF 265.00	778	MF 380.03	406	BV 463.10	413	BV 470.21T	790
OK 275.02	778	MF 380.04	406	BV 463.11	413	BV 470.22T	790
OK 275.03	778	MF 380.05	406	BV 463.12	413	BV 470.23T	790
OK 295.00	779	MF 381.00	406	BV 463.13	413	BV 470.24T	790
OK 295.01	779	MF 381.01	406	BV 463.14	413	BV 470.30T	790
OK 295.02	779	MF 381.02	406	BV 463.15	413	BV 470.31T	790
OK 296.00	779	MF 381.03	406	BV 463.16	413	BV 470.32T	790
FF 298.01	778	MF 381.04	406	BV 463.17	413	BV 470.33T	790
FF 298.02	778	MF 381.05	406	BV 463.20	413	BV 470.34T	790
FF 298.02B	778	MF 384.01	407	BV 463.21	413	BV 470.35T	790
FF 298.03	778	MF 384.02	407	BV 463.22	413	BV 470.40T	790
BV 300.00	396, 845	MF 386.00	407	BV 463.23	413	BV 470.41T	790
BV 301.00	396	MF 386.01	407	BV 463.24	413	BV 470.42T	790
BV 302.00	396	MF 386.02	407	BV 463.25	413	BV 470.43T	790
BV 304.00	396	MF 390.00	407	BV 463.26	413	BV 470.44T	790
BV 305.00	396	MF 392.00	407	BV 463.30	413	BV 470.45T	790
				BV 463.32	413	BV 463.62	414
				BV 450.12	411	BV 463.77	414
				BV 463.27	413		

Kat. No. Cat. No.	Sayfa. Page.	Kat. No. Cat. No.	Sayfa. Page.	Kat. No. Cat. No.	Sayfa. Page.	Kat. No. Cat. No.	Sayfa. Page.
BV 470.46T	790	BV 474.19T	416	BV 487.10	415	BV 524.00	423
BV 470.50T	417, 791	BV 474.21T	416	BV 487.11	415	BV 525.00	423
BV 470.51T	417, 791	BV 474.22T	416	BV 487.13	415	BV 528.00	424
BV 470.52T	417, 791	BV 474.23T	416	BV 487.15	415	BV 529.00	426
BV 470.53T	417, 791	BV 474.24T	416	BV 488.06	415	BV 530.00	424
BV 470.54T	417, 791	BV 474.25T	416	BV 488.07	415	BV 531.01	424
BV 470.55T	417, 791	BV 474.26T	416	BV 488.08	415	BV 531.02	424
BV 470.56T	417, 791	BV 474.27T	416	BV 488.09	415	BV 532.01	425
BV 470.57T	417, 791	BV 474.28T	416	BV 488.10	415	BV 534.00	425
BV 470.58T	417, 791	BV 474.29T	416	BV 488.11	415	BV 534.01	425
BV 471.00	416	BV 474.30T	416	BV 488.12	415	BV 534.02	425
BV 471.01	416	BV 474.50T	417, 791	BV 490.00	418, 786	BV 534.03	425
BV 471.02	416	BV 474.51T	417, 791	BV 490.01	418, 786	BV 534.20	425
BV 471.03	416	BV 474.52T	417, 791	BV 490.05	418, 786	EF 558.01	495
BV 471.04	416	BV 474.53T	417, 791	BV 490.06	418, 786	BV 560.00	421, 420, 422
BV 471.50T	417, 791	BV 474.54T	417, 791	BV 490.07	418, 786	BV 560.01	420, 422
BV 471.51T	417, 791	BV 474.55T	417, 791	BV 490.08	418, 786	BV 560.02	420, 422
BV 471.52T	417, 791	BV 474.56T	417, 791	BV 490.09	418, 786	BV 560.03	420, 422
BV 471.53T	417, 791	BV 474.57T	417, 791	BV 490.00	418, 786	BV 560.04	420, 422
BV 471.54T	417, 791	BV 474.58T	417, 791	BV 491.00	418, 786	BV 560.05	421, 422
BV 471.55T	417, 791	BV 475.50T	417, 791	BV 491.01	418, 786	BV 560.06	421, 422
BV 471.56T	417, 791	BV 475.51T	417, 791	BV 491.05	418, 786	BV 560.07	421, 422
BV 471.57T	417, 791	BV 475.52T	417, 791	BV 491.06	418, 786	BV 560.10	425
BV 471.58T	417, 791	BV 475.53T	417, 791	BV 491.07	418, 786	BV 560.11	425
BV 472.00	416	BV 475.54T	417, 791	BV 491.08	418, 786	BV 560.12	425
BV 472.01	416	BV 475.55T	417, 791	BV 491.09	418, 786	BV 560.13	425
BV 472.02	416	BV 475.56T	417, 791	BV 494.00	419, 787	BV 580.00	420
BV 472.03	416	BV 475.57T	417, 791	BV 495.00	419, 787	BV 580.03	420
BV 472.04	416	BV 475.58T	417, 791	BV 497.00	419, 787	BV 580.04	420
BV 472.05	416	BV 476.50T	417, 791	BV 498.00	419, 787	BV 580.05	420
BV 472.08T	416	BV 476.51T	417, 791	BV 500.00	420	BV 580.08	421
BV 472.09T	416	BV 476.52T	417, 791	BV 500.01	420	BV 580.10	421
BV 472.10T	416	BV 476.53T	417, 791	BV 500.10	420	BV 580.11	421
BV 472.11T	416	BV 476.54T	417, 791	BV 500.11	420	BV 580.16	421
BV 472.12T	416	BV 476.55T	417, 791	BV 501.00	420	BV 580.22	424
BV 472.13T	416	BV 476.56T	417, 791	BV 501.01	420	BV 580.23	425
BV 472.14T	416	BV 476.57T	417, 791	BV 502.00	420	BV 580.25	424, 425
BV 472.15T	416	BV 477.50T	417, 791	BV 502.01	420	BV 580.26	424, 425
BV 472.16T	416	BV 477.51T	417, 791	BV 502.04	420	BV 580.27	424, 425
BV 472.17T	416	BV 477.52T	417, 791	BV 503.01	420	BV 580.30	425
BV 472.50T	417, 791	BV 477.53T	417, 791	BV 503.02	420	BV 580.30	425
BV 472.51T	417, 791	BV 477.54T	417, 791	BV 503.03	420	BV 580.40	425
BV 472.52T	417, 791	BV 477.55T	417, 791	BV 503.06	420	BV 600.00	428
BV 472.53T	417, 791	BV 477.56T	417, 791	BV 503.07	420	BV 600.01	428
BV 472.54T	417, 791	BV 477.57T	417, 791	BV 505.00	421	BV 600.10	428
BV 472.55T	417, 791	BT 480.00	410	BV 505.01	421	BV 600.20	428
BV 472.56T	417, 791	BT 480.02	410	BV 506.00	421	BV 600.30	428
BV 472.57T	417, 791	BT 480.03	410	BV 506.01	421	BV 600.32	428
BV 472.58T	417, 791	BT 480.05	410	BV 506.04	421	BV 600.40	428
BV 473.50T	417, 791	BT 480.06	410	BV 506.05	421	BV 600.42	428
BV 473.51T	417, 791	BT 480.07	410	BV 506.06	421	BV 600.44	428
BV 473.52T	417, 791	BT 482.00	410, 648	BV 508.00	421	BV 600.46	428
BV 473.53T	417, 791	BT 482.01	410, 648	BV 508.01	421	BV 600.48	428
BV 473.54T	417, 791	BT 484.00	410	BV 515.00	494, 430	BV 602.00	428
BV 473.55T	417, 791	BV 486.02	415	BV 515.01	494	BV 602.01	428
BV 473.56T	417, 791	BV 486.03	415	BV 515.02	494, 430	US 604.00	426
BV 473.57T	417, 791	BV 486.04	415	BV 515.05	494, 430	US 604.01	426
BV 473.58T	417, 791	BV 486.05	415	BV 515.06	494, 430	US 604.10	426
BV 474.00	416	BV 486.06	415	BV 515.11	494, 430	US 604.11	426
BV 474.01	416	BV 486.07	415	BV 515.12	494	BV 605.00	427
BV 474.10T	416	BV 486.09	415	BV 518.00	467	BV 605.01	427
BV 474.11T	416	BV 486.11	415	BV 518.01	467	BV 605.02	427
BV 474.12T	416	BV 487.00	415	BV 518.05	467	BV 605.03	427
BV 474.13T	416	BV 487.01	415	BV 518.07	467	BV 605.10	427
BV 474.14T	416	BV 487.05	415	BV 518.10	467	BV 605.20	427
BV 474.15T	416	BV 487.06	415	BV 518.11	467	BV 605.22	427
BV 474.16T	416	BV 487.07	415	BV 518.12	467	BV 605.25	427
BV 474.17T	416	BV 487.08	415	BV 518.15	467	BV 605.27	427
BV 474.18T	416	BV 487.09	415	BV 520.00	423	BV 605.28	427
		BV 471.06	416	BV 522.00	580, 423	BV 605.30	427
		BV 471.07	416			BV 580.02	423
		BV 471.08	416				
		BV 471.09	416				
		BV 471.10	416				

Kat. No. Cat. No.	Sayfa. Page.	Kat. No. Cat. No.	Sayfa. Page.	Kat. No. Cat. No.	Sayfa. Page.	Kat. No. Cat. No.	Sayfa. Page.
BV 605.33	427	EL 765.04	510	FB 864.08	589	FF 143.00	780
BV 605.35	427	EL 770.01	509	FB 864.09	589	FF 143.01	780
BV 605.40	427	EL 771.01	510	FB 864.11	589	FF 144.00	782
BV 608.00	429	EL 771.02	510	FB 864.13	589	FF 144.01	782
BV 608.01	429	EL 771.03	510	FB 864.14	589	FF 145.00	781
BV 608.04	429	EL 771.04	510	FB 864.15	589	FF 145.01	781
BV 608.06	429	EL 771.05	510	FB 866.01	588	FF 146.00	781
BV 608.15	429	EL 771.06	510	BF 866.05	588	FF 146.01	781
BV 608.17	429	EL 780.01	511	FB 866.06	588	FF 147.00	782
BV 608.30	429	EL 781.01	511	FB 866.08	588	FF 148.00	782
BV 608.31	429	EL 781.05	511	FB 866.09	588	FF 149.00	783
BV 608.50	429	EL 782.01	511	FB 866.10	588	FF 149.01	783
BV 608.52	429	EL 782.05	511	FB 866.20	588	OL 150.01	596, 615
BV 608.54	429	EL 783.01	511	FC 875.00A	591	OL 152.01	614
BV 608.56	429	EL 785.01	508	FC 875.02A	591	OL 153.01	614
BV 608.58	429	EL 785.02	508	FC 875.05A	591	FF 154.01	615
BV 608.64	429	EL 785.03	508	FC 875.07A	591	FF 155.00	618
BV 608.66	429	EL 790.01	510	FC 875.10A	591	FF 156.01	596, 618
BV 608.68	429	EL 790.02	510	FC 875.13A	591	FF 156.02	596, 618
OK 650.00	462	EL 790.03	510	FC 895.00	821	FF 159.01	614
BV 685.00	467	EL 791.01	510	BV 901.00	790	OL 160.01	615
BV 690.00	467	EL 791.02	510	BV 903.00	431	OL 161.01	596, 614
EA 700.00	462	FB 800.00	580	BV 903.01	431	OL 162.01	614
EA 704.04	462	FB 800.02	580	BV 903.03T	431	OL 163.00	840
EA 705.00	462	FB 800.05	580	BV 903.04T	431	OL 165.01	615
EA 705.02	462	FB 800.06	580	FC 906.01	588	OL 166.01	615
EA 705.06	462	FB 800.07	580	FC 906.03	588	OL 167.00	616
EA 707.00	463	FB 800.08	580	FC 906.04	588	OL 168.01	616
EA 708.00	463	FB 800.09	580	FC 906.05	588	OL 168.03	616
EA 710.00	463	FB 802.00	580	FC 906.06	588	OL 169.00	616
EA 712.00	463	FB 803.00	581			OL 170.01	615
EA 714.00	464	FB 804.00	581			FF 175.01	616
EA 716.00	464	FB 806.00	581	FB 102.00	596	FF 175.02	616
EA 720.00	464	FB 807.00	581	FB 102.01	596	FF 177.01	617
EA 720.01	464	FB 808.00	582	FF 115.01	596, 614	FF 178.00	616
EA 720.02	464	FB 810.00	582	FF 116.00	614	FF 179.01	616
EA 721.00	464	FB 811.00	583	FF 116.01	614	FF 180.01	615
EA 721.01	464	FB 812.00	584	FF 117.01	614	FF 182.00	617
EA 721.02	464	FB 812.01	584	FB 120.00	596, 759	MF 182.01	617
EA 725.00	465	FB 812.05	584	FB 120.02	596, 759	MF 182.02	617
EA 725.01	465	FB 812.10	584	FB 122.00	759	MF 188.01	617
EA 725.02	465	FB 814.00	583	FB 122.01	759	MF 189.01	617
EA 728.00	465	FB 814.01	583	FD 125.01	596, 761	FK 190.01	616
EA 730.00	465	FB 814.05	583	FD 127.00	761	OL 191.01	617
EA 730.01	465	FB 814.06	583	FD 128.00	761	OL 193.01	619
EA 732.00	466	FB 814.07	583	FF 130.01	615, 759	OL 194.01	615
EA 736.00	466	FB 815.00	585	FF 130.02	615, 760	OL 196.01	619
EA 738.00	466	FB 815.01	585	FF 131.00	760	OL 197.01	619
EA 738.01	466	FB 815.05	585	FF 131.01	760	OL 198.01	619
EA 738.06	466	FB 815.06	585	FF 131.02	760	OL 199.00	618
EA 738.07	466	FB 815.07	585	FF 132.00	760	DO 200.01	620
EA 738.08	466	FB 815.08	585	FD 133.00	761	DO 201.01	620
EA 738.10	466	FB 815.09	585	FD 134.00	761	DO 202.00	618
EA 750.01	508	FB 820.00	586	FD 136.00	762	OM 205.02	619
EA 752.01	508	FB 820.01	586	FD 136.01	762	OM 205.04	619
EA 754.01	508	FB 826.00	586	FD 137.00	763	OM 208.02	619
EA 754.02	508	FB 826.05	586	FD 137.01	763	OM 208.04	619
EA 754.03	508	FB 826.06	586	FD 137.02	763	DO 210.00	620
EA 754.04	508	FB 826.10	586	FD 137.03	763	DO 210.01	620
EA 760.01	509	FB 828.02	587	FD 137.04	763	DO 211.00	620
EA 762.01	509	FB 828.04	587	FD 138.00	763	DO 212.00	620
EA 762.02	509	FB 830.01	590	FD 138.01	763	OL 213.00	620
EA 762.03	509	FB 830.02	590	FD 138.02	763	OM 214.00	620
EA 762.04	509	FB 830.05	590	FF 140.00	780	DO 215.00	620
EA 763.01	509	FB 830.06	590	FF 140.01	780	FK 216.00	620
EA 763.02	509	FB 864.00	589	FF 141.00	780	OM 218.00	621
EA 763.03	509	FB 864.05	589	FF 141.01	780	FK 219.01	621
EA 765.01	510	FB 864.06	589	FF 142.00	780	FK 220.00	622
EA 765.02	510	FB 864.07	589	FF 142.01	780	FK 220.01	622
		FB 826.01	586			FK 216.01	620

Kat. No. Cat. No.	Sayfa. Page.	Kat. No. Cat. No.	Sayfa. Page.	Kat. No. Cat. No.	Sayfa. Page.	Kat. No. Cat. No.	Sayfa. Page.
FK 220.02	622	FK 291.01	598, 632	FK 392.11	651	OL 608.01	656
FK 221.00	622	FK 291.02	598, 632	FK 392.12	651	FL 610.00	658
FK 221.01	622	FK 292.01	598, 632	FK 392.41	653	OF 613.00	779
FK 221.02	622	FK 293.01	598, 632	FK 393.01	654	OF 614.00	621
FK 221.03	622	FK 294.00	627	FK 393.41	655	FL 615.01	656
FK 221.04	622	FK 300.02	629	FK 399.01	655	FL 615.02	656
FK 222.00	622	FK 300.05	629	FK 399.02	655	FL 615.03	656
FK 222.01	622	FK 300.11	629	FK 399.03	655	FL 615.04	656
FK 222.02	622	FK 300.13	629	FK 399.04	655	FL 615.05	656
FK 223.00	622	FK 300.14	629	FK 400.00	636	FL 616.01	656
FK 223.01	622	FK 305.01	629	FK 401.00	636	FL 616.02	656
FK 223.02	622	FK 305.02	629	FK 402.00	636	FL 616.03	656
OL 225.01	622	FK 305.03	629	FK 402.01	636	FL 616.04	656
OL 225.02	622	FK 306.01	629	FK 403.00	636	FL 616.05	656
OL 227.01	622	FK 306.02	629	FK 405.00	636	FL 617.01	656
OL 227.02	622	FK 306.03	629	FK 406.00	636	FL 617.02	656
OL 227.03	622	FK 307.02	628	FK 407.01	638	FL 617.03	656
FK 230.01	623	FK 307.03	628	FK 408.01	638	FL 617.04	656
FK 230.02	623	FK 307.05	628	FK 410.01	637	FL 618.01	656
FK 230.03	623	FK 307.07	628	FK 411.02	637	FL 618.02	656
FK 230.04	623	FK 307.08	628	FK 412.01	637	FL 618.03	656
OL 232.01	623	FK 310.01	630	FK 412.02	637	FL 618.04	656
FK 233.01	623	FK 310.01P	631	FK 413.01	639	FL 618.05	656
FK 234.01	623	FK 311.01	630	FK 413.03	639	OL 619.01	659
FK 235.01	623	FK 311.01P	631	FK 414.01	640	OL 619.02	659
DO 236.01	623	FK 311.02	630	FK 415.02	641	OL 619.03	659
DO 236.02	623	FK 311.02P	631	FK 416.02	641	FL 620.01	657
FK 237.10	621	FK 313.01	630	FK 418.02	640	FL 620.02	657
FK 238.00	621	FK 313.01P	631	FK 419.00	628	FL 620.03	657
FK 240.01	624	FK 315.01	630	FK 419.01	628	FL 620.04	657
FK 241.01	624	FK 315.01P	631	FK 419.03	628	FL 621.01	657
FK 242.01	624	FK 316.01	630	FK 419.05	628	FL 621.02	657
FK 243.01	624	FK 316.01P	631	FK 420.02	642	FL 621.03	657
FK 245.01	624	FK 317.01	630	FK 421.02	642	FL 621.04	657
FK 245.02	624	FK 317.01P	631	FK 421.03	642	FL 621.05	657
FK 250.01	624	FK 320.02P	633	FK 422.01	641	FL 622.01	657
FK 252.01	624	FK 322.02P	633	FK 423.02	643	FL 622.02	657
FK 253.01	624	FK 322.04P	633	FK 424.02	643	FL 622.03	657
FK 255.01	624	OG 328.01	621	FK 425.02	646	FL 622.04	657
DO 258.00	625	OM 330.01	634	FK 426.01	638	FL 622.05	657
FK 260.00	626	OM 330.02	634	FK 427.01	644	FL 625.01	657
FK 261.00	626	FK 332.01	634	FK 428.01	646	FL 625.02	657
FK 263.00	626	FK 335.01	634	FK 429.02	644	FL 625.03	657
FK 264.00	626	FK 335.02	634	FK 431.02	647	FL 625.04	657
FK 265.01	597, 625	FK 337.01	634	FK 434.01	644	OL 630.01	657
FK 266.01	625	FK 339.01	634	FK 435.01	645	OL 630.02	657
FK 270.01	625	FK 340.01	634	FK 435.02	645	OL 630.03	657
FK 271.01	625	FK 341.01	634	FK 437.01	645	OL 630.04	657
OM 272.01	621	FK 341.02	634	FK 437.02	645	OL 630.05	657
OM 273.01	621	MB 341.05	625	FK 437.03	645	OL 631.01	657, 779
FK 275.01	625	FK 343.01	635	FK 440.00	647	OL 631.02	657, 779
FK 276.01	625	FK 345.01	635	FK 442.02	647	OL 631.03	657, 779
FK 278.01	597, 626	FK 346.01	635	OL 567.00	788	OL 631.04	657, 779
FK 278.02	597, 626	FK 348.01	635	OL 567.01	788	OL 632.01	657
FK 278.03	597, 626	FK 349.02P	635	OL 567.02	788	OL 633.01	657
FK 278.04	597, 626	FK 390.00	649	OL 567.04	788	FL 635.00	658
FK 278.05	597, 626	FK 390.01	649	OL 568.00	788	FL 635.01	658
OG 279.00	621	FK 390.02	649	OL 569.00	788	FL 635.02	658
DO 280.01	627	FK 390.10	649	FB 580.00	599	FL 636.00	658
DO 281.01	627	FK 390.11	649	FB 580.01	599	DO 637.00	658
DO 282.00	626	FK 390.21	650	FB 580.02	599	DO 637.01	658
FK 285.00	597, 626	FK 390.22	650	FB 580.05	599	DO 638.00	658
FK 289.01	596, 627	FK 390.30	650	FB 580.06	599	DO 638.01	658
FK 289.02	597, 627	FK 390.41	652	FB 580.07	599	OL 640.01	659
FK 289.03	597, 627	FK 390.51	653	FB 598.00	606	OL 640.02	659
FK 289.04	597, 627	FK 390.60	654	FL 600.00	656	OL 641.01	659
FK 289.05	597, 627	FK 391.41	652	FL 600.01	656	OL 641.02	659
FK 290.01	598, 632	FK 392.01	651	OL 605.00	656	OL 642.00	659
FK 290.02	598, 632	FK 392.02	651	OL 606.00	656	OL 642.01	659

Kat. No. Cat. No.	Sayfa. Page.	Kat. No. Cat. No.	Sayfa. Page.	Kat. No. Cat. No.	Sayfa. Page.	Kat. No. Cat. No.	Sayfa. Page.
OL 642.02	659	MB 670.06	661	FL 706.01P	663	FL 757.02	669
FL 645.01	659	MB 670.07	661	FL 706.02P	663	FL 757.03	669
FL 645.02	659	MB 671.01	661	FL 706.03P	663	FG 758.01	669
FL 645.03	659	MB 671.02	661	FL 706.04P	663	FG 758.02	669
FL 645.04	659	MB 671.03	661	FL 706.05P	663	FG 758.03	669
FL 645.05	659	MB 671.04	661	FL 708.01P	663	FG 758.04	669
FL 645.06	659	MB 671.05	661	FL 708.02P	663	FG 766.00	7
OL 647.01	659	MB 671.06	661	FL 708.03P	663	FG 766.01	7
OL 647.02	659	MB 671.07	661	FL 708.04P	663	FG 766.03	7
OL 647.03	659	MB 673.01	661	FL 708.05P	663	FG 766.04	7
OL 647.04	659	MB 673.02	661	FL 708.06P	663	FL 800.01	671
FL 650.04	660	MB 673.03	661	FL 708.07P	663	FL 800.05	671
FL 650.05	660	MB 673.04	661	FL 709.01P	663	FL 801.00	671
FL 650.06	660	MB 673.05	661	FL 709.02P	663	FL 801.05	671
FL 650.07	660	MB 673.06	661	FL 709.03P	663	FL 802.01	671
FL 650.08	660	MB 673.07	661	FL 709.04P	663	FL 802.02	671
FL 651.04	660, 835	MB 674.01	661	FL 709.05P	663	FL 803.00	671
FL 651.05	660, 835	MB 674.02	661	FL 709.06P	663	FL 803.02	671
FL 651.06	660, 835	MB 674.03	661	FL 709.07P	663	FL 803.03	671
FL 651.07	660, 835	MB 674.04	661	FL 711.03P	817	TE 803.10	671
FL 651.08	660, 835	MB 674.05	661	FL 711.03P	664	FL 805.01	673
FL 651.09	660, 835	MB 674.06	661	FL 713.01P	664	FL 805.02	673
FL 653.04	660	MB 674.07	661	FL 713.02P	664	FL 805.03	673
FL 653.05	660	FL 677.00	658	ND 714.01P	667	DF 810.01	670
FL 653.06	660	FL 677.02	658	ND 714.02P	667	DF 811.01	670
FL 653.07	660	FL 678.00	658	ND 714.03P	667	FL 812.01	670
FL 653.08	660	FL 678.02	658	ND 714.04P	667	FL 814.01	670, 788
FL 654.04	660	FL 679.00	658	FL 716.01P	664	FL 814.03	670
FL 654.05	660	FL 679.02	658	FL 716.02P	664	FL 815.01	672, 779
FL 654.06	660	FL 680.01	662	FL 716.03P	664	FL 816.01	672
FL 654.07	660	FL 680.02	662	FL 720.05P	665	FL 816.03	672
FL 654.08	660	FL 680.03	662	ND 721.04P	665	FL 818.02	672, 835
FL 656.04	660	FL 680.04	662	ND 723.04P	665	FL 819.02	673
FL 656.05	660	FL 680.05	662	ND 723.05P	665	FL 820.02	672
FL 656.06	660	FL 680.06	662	FL 725.02P	664	FL 821.02	673
FL 656.07	660	FL 680.07	662	ND 727.01P	666	FL 822.02	673
FL 656.08	660	FL 680.08	662	ND 727.02P	666	FL 824.00	670
FL 656.09	660	FL 680.09	662	ND 728.01P	666	FL 826.00	670
FL 656.10	660	FL 680.10	662	ND 728.02P	666		
FL 656.11	660	FL 680.11	662	ND 729.01P	666		
FL 656.12	660	FL 680.12	662	ND 729.02P	666	FD 100.00	762
FL 681.02	662	FL 681.02	662	ND 735.01P	667	FD 101.01	762
FL 681.04	662	FL 681.04	662	ND 735.02P	667	FD 102.00	763
FL 681.06	662	FL 681.06	662	ND 736.01P	668	FF 105.00	781
FL 681.08	662	FL 681.08	662	ND 737.01P	666	FF 106.00	781
FL 681.09	662	FL 681.09	662	ND 740.02	668	FF 107.00	783
FL 681.10	662	FL 681.10	662	ND 741.02	668	FF 108.00	783
DO 683.03	662	DO 683.03	662	ND 742.02	668	FF 109.00	783
DO 684.02	662	DO 684.02	662	ND 743.02	668	FF 110.00	784
DO 684.04	662	DO 684.04	662	ND 745.00	822	FF 111.00	784
FL 700.00P	662	FL 700.00P	662	ND 745.01	822	FF 113.00	784
FL 700.01	662	FL 700.01	662	ND 745.02	822	FF 113.02	784
FL 700.02	662	FL 700.02	662	ND 746.00	822	FF 115.01	785
FL 700.03	662	FL 700.03	662	ND 746.01	822	FF 116.01	785
FL 700.04	662	FL 700.04	662	ND 746.02	822	FF 117.01	785
FL 700.05	662	FL 700.05	662	ND 747.00	822	FF 127.01	762
FL 700.07	662	FL 700.07	662	ND 747.01	822	FK 130.00	676
FL 700.08	662	FL 700.08	662	ND 747.02	822	FK 131.00	676
FL 700.09	662	FL 700.09	662	FL 750.00	669	FK 131.01	676
DO 703.03P	663	DO 703.03P	663	FL 751.00	669	FK 132.00	676
DO 703.04P	663	DO 703.04P	663	FL 751.01	669	FK 133.00	676
DO 703.05P	663	DO 703.05P	663	FL 755.00	669	FK 135.00	676
DO 704.03P	663	DO 704.03P	663	FL 755.01	669	FK 136.00	676
DO 704.04P	663	DO 704.04P	663	FL 755.02	669	FK 140.00	676
DO 704.05P	663	DO 704.05P	663	FL 755.03	669	FK 140.01	676
FL 705.01P	663	FL 705.01P	663	FF 756.01	669	FK 140.03	676
FL 705.02P	663	FL 705.02P	663	FF 756.02	669	FK 142.00	676
FL 705.03P	663	FL 705.03P	663	FF 756.03	669	FK 142.01	676
FL 705.04P	663	FL 705.04P	663	FL 757.01	669	FK 142.03	676
FL 705.05P	663	FL 705.05P	663				

Kat. No. Cat. No.	Sayfa. Page.	Kat. No. Cat. No.	Sayfa. Page.	Kat. No. Cat. No.	Sayfa. Page.	Kat. No. Cat. No.	Sayfa. Page.
DO 150.00	677	FK 182.02	679	FK 203.09	681	OL 310.02	690
DO 151.00	677	FK 182.03	679	FK 205.01	682	OL 312.01	690
DO 152.00	677	FK 182.04	679	FK 205.02	682	OL 315.01	690
DO 152.01	677	FK 182.05	679	FK 205.03	682	OL 316.01	690
DO 153.00	677	FK 182.06	679	FK 205.04	682	DO 320.01	691
DO 153.01	677	FK 183.01	679	FK 205.05	682	DO 321.01	691
DO 153.02	677	FK 183.02	679	FK 205.06	682	DO 322.01	691
DO 153.03	677	FK 183.03	679	FK 205.07	682	OL 325.01	691
DO 153.04	677	FK 183.04	679	FK 205.08	682	OL 326.01	691
DO 155.00	677	FK 183.05	679	FK 205.09	682	OL 328.01	691
DO 155.01	677	FK 183.06	679	FK 206.01	682	OL 332.01	692
HH 160.00	840	FK 184.01	679	FK 206.02	682	OL 332.02	692
HH 161.00	840	FK 184.02	679	FK 206.03	682	OL 332.03	692
HH 164.00	840	FK 184.03	679	FK 206.04	682	OL 332.04	692
HH 164.01	840	FK 184.04	679	FK 206.05	682	OL 332.05	693
HH 164.02	840	FK 184.05	679	FK 206.06	682	FK 335.01	691
HH 164.03	840	FK 184.06	679	FK 206.07	682	FK 337.00	5
HH 165.00	840	FK 185.01	680	FK 206.08	682	FK 340.01	691
HH 165.01	840	FK 185.02	680	FK 206.09	682	FK 345.01	693
HH 165.02	840	FK 185.03	680	MB 210.01	682	FK 347.01	693
HH 165.03	840	FK 185.04	680	MB 210.02	682	FK 348.01	693
HH 165.04	840	FK 186.01	680	MB 210.03	682	EB 405.02	479
HH 165.05	840	FK 186.02	680	MB 210.04	682	EB 405.03	479
DO 170.00	683	FK 186.03	680	MB 210.05	682	EB 405.04	479
DO 170.01	683	FK 186.04	680	MB 210.06	682	EB 405.05	479
DO 171.00	683	FK 186.05	680	MB 210.07	682	EB 410.02	479
DO 171.01	683	FK 187.01	680	MB 210.08	682	EB 410.03	479
FK 173.00	683	FK 187.02	680	MB 210.09	682	EB 410.04	479
FK 175.01	678	FK 187.03	680	MB 211.01	682	EB 410.05	479
FK 175.02	678	FK 188.01	683	MB 211.02	682	EB 410.06	479
FK 175.04	678	FK 188.02	683	MB 211.03	682	EB 410.07	479
FK 175.05	678	FK 188.03	683	MB 211.04	682	EB 410.08	479
FK 175.06	678	FK 190.01	680	MB 211.05	682	EB 410.09	479
FK 175.08	678	FK 190.02	680	MB 211.06	682	MF 420.00	684
FK 175.09	678	FK 190.03	680	MB 211.07	682	MF 420.01	684
FK 176.01	678	FK 190.04	680	MB 211.08	682	MF 420.02	684
FK 176.02	678	FK 192.01	680	MB 211.09	682	MF 420.03	684
FK 176.03	678	FK 192.02	680	FK 230.00	686	MF 420.04	684
FK 176.04	678	FK 192.03	680	FK 230.01	686	MF 420.10	684
FK 176.05	678	FK 192.04	680	FK 232.00	686	MF 420.11	684
FK 176.06	678	FK 193.01	680	FK 232.01	686	MF 420.12	684
FK 176.07	678	FK 193.02	680	FK 260.01P	687	MF 420.13	684
FK 177.01	678	FK 193.03	680	FK 260.02P	687	MF 420.14	684
FK 177.02	678	FK 200.01	681	FK 260.03P	687	MF 421.00	684
FK 177.03	678	FK 200.02	681	FK 261.01P	687	MF 421.01	684
FK 177.04	678	FK 200.03	681	FK 261.02P	687	MF 421.02	684
FK 177.05	678	FK 200.04	681	FK 261.03P	687	MF 421.03	684
FK 177.06	678	FK 200.05	681	FK 270.01P	686	MF 421.04	684
FK 177.07	678	FK 200.06	681	FK 270.02P	686	MF 421.10	684
FK 178.01	678	FK 200.07	681	FK 270.03P	686	MF 421.11	684
FK 178.02	678	FK 200.08	681	FK 280.01P	689	MF 421.12	684
FK 178.03	678	FK 200.09	681	FK 280.02P	689	MF 421.14	684
FK 178.04	678	FK 202.01	681	FK 280.03P	689	MF 423.00	684
FK 178.05	678	FK 202.02	681	FK 280.04P	689	MF 423.01	684
FK 178.06	678	FK 202.03	681	FK 281.02P	689	MF 423.02	684
FK 178.07	678	FK 202.04	681	FG 283.01	687	MF 423.03	684
FK 179.01	679	FK 202.05	681	FG 283.02	687	MF 423.04	684
FK 179.02	679	FK 202.06	681	FG 283.03	687	MF 423.10	684
FK 179.03	679	FK 202.07	681	FG 283.04	687	MF 423.11	684
FK 179.04	679	FK 202.08	681	FG 284.01	687	MF 423.12	684
FK 179.05	679	FK 202.09	681	FG 284.02	687	MF 423.13	684
FK 179.06	679	FK 203.01	681	FG 284.03	687	MF 423.14	684
FK 179.07	679	FK 203.02	681	FG 284.04	687	MF 424.00	684
FK 179.08	679	FK 203.03	681	OL 300.01	690	MF 424.01	684
FK 179.09	679	FK 203.04	681	OL 301.01	690	MF 424.02	684
FK 179.10	679	FK 203.05	681	OL 303.01	690	MF 424.03	684
FK 180.01	679	FK 203.06	681	OL 304.01	690	MF 424.04	684
FK 180.02	679	FK 203.07	681	OL 305.00	690	MF 424.10	684
FK 182.01	679	FK 203.08	681	OL 310.01	690	MF 424.11	684
FK 174.00	683						

Kat. No. Cat. No.	Sayfa. Page.	Kat. No. Cat. No.	Sayfa. Page.	Kat. No. Cat. No.	Sayfa. Page.	Kat. No. Cat. No.	Sayfa. Page.
MF 424.12	684	ER 530.09	558	FO 151.00	700	FO 309.01	713
MF 424.13	684	ER 530.12	558	FO 152.00	700, 835	FO 310.01	714
MF 424.14	684	ER 530.15	558	FO 155.00	701	FO 310.02	714
MF 430.00	685	ER 530.19	558	FO 155.01	701	FO 311.00	714
MF 430.01	685	ER 530.21	558	FO 156.01	701	FO 311.02	714
MF 430.02	685	ER 532.07	558	FO 160.00	702	FO 312.00	714
MF 430.10	685	ER 532.09	558	FO 160.01	702	FO 315.01	714
MF 430.11	685	ER 532.12	558	FO 161.00	703	FO 316.01	715
MF 430.12	685	ER 532.15	558	FO 161.01	703	FO 318.01	715
MF 431.00	685	ER 532.19	558	FO 161.02	703	FO 320.01	715
MF 431.01	685	ER 532.21	558	FO 163.00	704	FO 321.01	715
MF 431.02	685	ER 534.07	558	FO 163.01	704	FO 323.01	712
MF 431.10	685	ER 534.09	558	FO 163.02	705	FO 325.01	611, 716
MF 431.11	685	ER 534.12	558	FO 170.01	705	FO 326.01	716
MF 431.12	685	ER 534.15	558	FO 170.02	705	FO 327.01	712
MF 432.00	685	ER 534.19	558	FO 170.03	705	FO 329.01	712
MF 432.01	685	ER 534.21	558	FO 170.04	705	FO 333.01	611, 717
MF 432.02	685	ER 540.16	558	FO 170.05	705	FO 335.01	611, 717
MF 432.10	685	ER 540.20	558	FO 171.00	705	FG 338.02	717
MF 432.11	685	ER 540.23	558	FO 172.01	705	FO 350.01	718
ER 500.06	556, 688	ER 540.27	558	FO 172.02	705	FO 352.00	718
ER 500.07	556, 688	ER 540.31	558	FO 172.03	705	OK 355.00	718
ER 500.08	556, 688	ER 540.36	558	FO 176.01	706	FO 358.01	718
ER 500.09	556, 688	ER 540.41	558	FO 176.02	706	FO 358.02	718
ER 500.10	556, 688	ER 550.34	559	FO 176.03	706	FO 358.03	718
ER 500.11	556, 688	ER 550.44	559	FO 177.00	706	FO 358.04	718
ER 502.06	556, 688	ER 552.24	559	FO 178.00	706	FO 359.02	718
ER 502.07	556, 688	ER 552.35	559	FO 180.00	707	FO 359.03	718
ER 502.08	556, 688	ER 554.24	559	FO 180.01	707	FO 359.04	718
ER 502.09	556, 688	ER 554.30	559	FO 180.02	707	FO 365.00	719
ER 502.10	556, 688	ER 554.35	559	FO 183.00	707	FO 366.00	719
ER 502.11	556, 688	ER 560.05	560	FO 185.00	707	FO 367.00	719
ER 510.06	556, 688	ER 561.02	560	FO 251.01	708	FO 368.00	719
ER 510.08	556, 688	ER 565.04	560	FO 260.01	708	FO 370.00	719
ER 510.10	556, 688	ER 570.08	560	FO 260.02	708	FO 371.00	719
ER 510.12	556, 688	ER 580.02	550	FO 264.00	708	FO 375.01	720
ER 510.14	556, 688	ER 581.02	550	FO 264.10	708	FO 376.01	720
ER 520.04	557	ER 585.01	502, 550	FO 265.00	709	FO 377.01	720
ER 520.08	557	ER 595.04	550	FO 266.00	709	FO 378.01	610, 721
ER 520.09	557	ER 595.05	550	FO 267.00	709	FO 379.01	610, 721
ER 520.12	557	ER 598.00	550	FO 268.00	709	OF 400.01	722
ER 520.15	557	ER 600.00P	689	FO 270.00	709	OF 401.00	722
ER 520.19	557	ER 602.00P	689	FO 271.00	709	OK 405.00	722
ER 520.21	557	ER 606.00P	689	FO 272.01	708	OK 405.01	722
ER 520.24	557			FO 274.01	708	OK 405.02	722
ER 520.27	557			FO 275.00	709	OK 412.00	723
ER 520.30	557	FO 100.00	696	FO 276.00	709	OK 412.01	723
ER 520.34	557	FO 102.00	696	FO 277.00	710	OK 413.00	723
ER 520.38	557	FO 103.00	696	FO 278.00	710	OK 413.01	723
ER 525.09	557	FO 105.00	696	FO 279.00	711	OK 415.00	724
ER 525.12	557	FO 106.00	696	FO 280.00	710	FF 410.00	724
ER 525.15	557	FO 107.01	696	FO 282.00	710	FF 430.00	729
ER 525.19	557	FO 110.00	697	FO 285.00	711	FF 430.01	729
ER 525.21	557	FO 112.00	697	FO 286.00	710	FF 430.02	729
ER 525.24	557	FO 113.00	697	FO 287.00	710	FF 430.03	729
ER 525.27	557	FO 115.00	698	FO 290.00	711	FF 430.04	729
ER 525.30	557	FO 120.01	697	FO 292.01	708	FF 430.05	729
ER 528.08	557	FO 123.00	697	FO 295.00	711	FF 431.00	727
ER 528.09	557	FO 124.00	697	FO 296.00	711	FF 431.01	727
ER 528.12	557	FO 125.00	699	FO 297.00	712	FF 431.02	727
ER 528.15	557	FO 126.00	699	FO 298.00	712	FF 431.03	727
ER 528.19	557	FO 130.01	698	FO 299.00	712	FF 431.04	727
ER 528.21	557	FO 135.00	608, 699, 835	FO 300.00	713	FF 431.05	727
ER 528.24	557	FO 136.00	608, 699	FO 300.01	713	FF 432.00	728
ER 528.27	557	MD 140.01	698	FO 302.00	713	FF 432.01	728
ER 528.30	557	FO 142.00	700	FO 303.00	713	FF 432.02	728
ER 528.34	557	FO 143.00	700	FO 304.01	713	FF 432.03	728
ER 528.38	557	FO 143.01	700	FO 306.01	713	FF 432.04	728
ER 530.07	558	FO 150.00	700	FO 308.01	713	FO 350.00	718
				FO 291.00	711		

Kat. No. Cat. No.	Sayfa. Page.	Kat. No. Cat. No.	Sayfa. Page.	Kat. No. Cat. No.	Sayfa. Page.	Kat. No. Cat. No.	Sayfa. Page.
FF 433.00	727	LX 608.00	797	FK 705.06	727	FK 754.04B	726
FF 433.01	727	LX 608.02	797	FK 707.02	727	FK 754.05	726
FF 433.02	727	LX 610.00	802	FK 707.03	727	FK 754.05B	726
FF 433.03	727	LX 611.00	803	FK 707.04	727	FK 757.01	728
FF 433.04	727	LX 612.00	803	FK 707.05	727	FK 757.02	728
FF 433.05	727	LX 613.00	803	FK 709.01	726	FK 757.03	728
FF 434.00	729	LX 614.00	803	FK 709.01B	726	FK 757.04	728
FF 434.01	729	LX 615.00	803	FK 709.02	726	FK 757.05	728
FF 434.02	729	LX 616.00	803	FK 709.02B	726		
FF 434.03	729	DP 617.00	803, 815	FK 709.03	726	OK 320.00	732
FF 434.04	729	LX 618.01	804	FK 709.03B	726	OK 322.00	732
FF 435.00	728	LX 618.02	804	FK 709.04	726	OK 324.00	732
FF 435.01	728	LX 618.03	804	FK 709.04B	726	OK 325.00	732
FF 435.02	728	LX 618.05	804	FK 709.05	726	OK 327.00	732
FF 435.03	728	LX 620.00	804	FK 709.05B	726	OK 328.01	733
FF 435.04	728	LX 621.00	804	FK 709.06	726	OK 328.02	733
FF 436.01	725	LX 625.00	804	FK 709.06B	726	OK 328.03	733
FF 436.02	725	LX 625.00	804	FK 710.02	726	OK 328.04	733
FF 436.03	725	HB 627.00	803	FK 710.02B	726	OK 330.00	733
FF 436.04	725	LX 630.00	805	FK 710.03	726	OK 331.01	733
FF 437.01	728	LX 630.01	805	FK 710.03B	726	OK 331.02	733
FF 437.02	728	LX 632.00	805	FK 710.04	726	OK 332.00	735
FF 437.03	728	LX 634.00	806	FK 710.04B	726	OK 335.01	736
FF 437.04	728	LX 635.00	806	FK 710.05	726	OK 335.03	735
FF 438.01	729	LX 639.00	806	FK 710.05B	726	OK 340.00	733
FF 438.02	729	LX 640.00	807, 815	FK 710.06	726	OK 360.00	735
FF 438.03	729	LX 641.00	807	FK 710.06B	726	OK 360.01	735
FF 438.04	729	LX 643.00	806	FK 712.02	726	OK 360.02	735
FF 438.05	729	LX 645.00	807	FK 712.02B	726	OK 360.03	735
FF 439.03	724	LX 647.00	808	FK 712.03	726	OK 360.04	735
FF 441.01	729	LX 648.00	808	FK 712.03B	726	OK 362.00	735
FF 441.02	729	LX 649.00	807	FK 712.04	726	OK 362.01	735
FF 441.03	729	LX 649.05	806	FK 712.04B	726	OK 362.02	735
FF 441.04	729	DP 650.00	808	FK 712.05	726	FF 370.00	739
FF 441.05	729	LX 651.00	808	FK 712.05B	726	FF 370.01	739
FF 449.02	729	LX 652.00	809	FK 714.01	728	FF 371.02	739
FF 449.03	729	LX 655.00	809	FK 714.02	728	FF 375.00	738
FF 449.04	729	FO 660.00	818	FK 714.03	728	FF 375.01	738
FF 449.05	729	FO 661.00	818	FK 714.04	728	FF 375.02	738
FF 452.02	729	FO 662.00	818	FK 714.05	728	FF 375.03	738
FF 452.03	729	FO 664.00	818	FK 717.02	728	FF 377.00	738
FF 452.04	729	FO 670.00	824	FK 717.03	728	FF 377.01	738
FF 452.05	729	FO 670.01	824	FK 717.04	728	FF 377.02	738
FF 453.02	728	LX 675.00	817	FK 717.05	728	FF 377.02	738
FF 453.03	728	LX 681.00	5	FK 750.01	726	FF 379.00	738
FF 453.04	728	LX 682.00	5	FK 750.01B	726	FF 379.01	738
FF 453.05	728	LX 683.00	815	FK 750.02	726	FF 379.02	738
EB 470.00	778	HF 685.00	824	FK 750.02B	726	FF 380.00	739
FB 500.01	609	FO 686.00	824	FK 750.03	726	FF 383.01	739
FB 500.02	609	FK 701.01	727	FK 750.03B	726	FF 384.01	739
FB 502.01	609	FK 701.01B	727	FK 750.04	726	FF 385.01	739
FB 505.00	606	FK 701.02	727	FK 750.04B	726	FF 386.02	739
FB 510.00	609	FK 701.02B	727	FK 750.05	726	FF 387.02	739
FB 513.01	609, 835	FK 701.03	727	FK 750.05B	726	FF 388.02	739
FB 515.00	609	FK 701.03B	727	FK 752.01	726	FF 390.00	741
FB 520.01	609	FK 701.04	727	FK 752.01B	726	FF 390.01	741
EF 543.00	500	FK 701.04B	727	FK 752.02	726	FF 390.02	741
EF 545.00	500	FK 701.05	727	FK 752.02B	726	FF 390.05	741
EF 560.00	748	FK 701.05B	727	FK 752.03	726	FF 390.06	741
EF 560.01	748	FK 701.06	727	FK 752.03B	726	FF 390.07	741
FF 562.00	749	FK 701.06B	727	FK 752.04	726	FF 390.08	741
FF 562.01	749	FK 703.02	727	FK 752.04B	726	FF 390.09	741
FF 564.00	749	FK 703.03	727	FK 752.05	726	FF 390.10	741
FF 570.00	748	FK 703.04	727	FK 752.05B	726	FF 390.11	741
FF 572.00	748	FK 703.05	727	FK 754.02	726	FF 390.12	741
OK 580.00	779	FK 705.01	727	FK 754.02B	726	FF 390.13	741
LX 600.00	797	FK 705.02	727	FK 754.03	726	FF 390.14	741
LX 602.00	797	FK 705.03	727	FK 754.03B	726	FF 392.01	741
LX 605.00	797	FK 705.04	727	FK 754.04	726	FF 392.02	741
FF 418.00	797	FK 705.05	727	FK 365.00	734	FF 390.03	741
FG 438.03	797	FK 705.05	727	FK 366.00	734	FF 390.04	741
				FK 395.02	734	FF 392.03	741

Kat. No. Cat. No.	Sayfa. Page.	Kat. No. Cat. No.	Sayfa. Page.	Kat. No. Cat. No.	Sayfa. Page.	Kat. No. Cat. No.	Sayfa. Page.
FF 392.06	741	EA 813.00	468	FF 530.20	771	FF 084.02	204, 755
FF 392.07	741	EA 820.02	469	FF 530.21	771	FF 085.00	782
FF 392.08	741	EA 821.02	469	FF 530.29	771, 773	FF 086.00	755, 826
FF 392.11	741	EA 822.02	469	FF 530.30	771	FF 088.00	826
FF 392.12	741	EA 823.02	469	FF 530.32	771, 773	FF 088.01	826
FF 392.13	741	EA 824.02	469	FF 530.33	771	FF 089.01	826
FF 394.01	741	OP 830.02	469, 554	FF 530.34	771	FF 089.03	826
FF 394.02	741	OP 830.05	469, 554	FF 530.35	771, 773	OG 100.00	3
FF 394.06	741	EA 840.05	469	FF 530.37	773	OG 255.01	832
FF 394.07	741	FB 850.01	604	FF 530.39	773	OG 330.01T	769
FF 394.11	741	FC 852.03	605	FF 530.50	774	OG 330.03T	769
FF 394.12	741	FC 852.04	605	FF 531.00	772	OG 330.05T	769
FF 400.01	742	FC 852.05	605	FF 531.01	772	OG 332.01T	769
ND 402.02	742	FC 852.13	605	FF 531.02	773	OG 332.03T	769
FG 405.02	742	FC 852.14	605	FF 531.03	773	OG 332.05T	769
FF 410.00	740	FC 852.15	605	FF 531.05	773	OG 340.01T	769
FF 412.00	740	FC 852.23	605	FF 531.08	773	OG 340.03T	769
FF 412.01	740	FC 852.24	605	FF 531.10	772	OG 341.01T	769
FF 415.00	740	FC 852.25	605	FF 531.11	772	OG 341.06T	769
FF 417.01	740	FC 855.33	605	FF 531.12	772	OG 343.03T	769
FF 420.01	736	FC 855.34	605	FF 540.01	776	OG 343.06T	769
FF 423.01	737	FC 855.35	605	FF 540.02	776	OG 350.01T	769
FF 423.02	737			FF 540.04	776	OG 350.06T	769
FF 423.03	737	FD 001.00	208	FF 540.05	776	OG 351.03T	769
FF 425.01	737	FD 002.00	208	FF 540.16	776	OG 351.06T	769
FF 425.02	737	FD 003.00	208	FF 541.04	776	OG 353.03T	769
FF 425.03	737	FD 005.00	208	FF 542.00	777	OG 353.06T	769
FF 426.01	737	FD 005.01	208	FF 542.02	777	LX 380.00	698, 799
FF 426.02	737	FD 005.05	208	FF 542.03	777	FO 381.00	698
FF 428.01	736	FD 005.06	208	FF 542.04	777	EM 400.01	529
FF 430.00	742	FD 010.00	210, 209	FF 542.05	777	EM 401.01	529
FF 431.00	742	FD 011.00	209	FF 542.06	777	EO 420.00	546
FF 432.00	743	FD 012.00	209	FF 542.07	777	EO 421.00	546
FF 450.01	743	FD 013.00	209	FF 542.10	777	ET 425.00	567
FF 450.02	743	FD 014.00	209, 845	FF 542.12	777	ET 428.00	547
FF 450.05	743	FD 015.00	209	FF 542.14	777	ET 428.03	548
FF 455.01	743	FD 020.00	209	LX 550.00	798	ET 430.01	575
ER 700.02	551	FD 021.00	209	LX 550.01	798	EF 460.00	501
ER 705.02	551	FD 022.00	209	LX 551.00	798	EF 461.00	501
ER 710.01	551	FD 023.00	209	LX 552.00	799	EF 465.00	501
ER 710.03	551	FD 024.00	210	LX 552.01	799	EF 465.01	501
ER 715.01	551	FD 025.00	211, 845	LX 552.02	799	EF 465.02	501
ER 715.02	551	FD 026.00	211, 845	LX 552.03	799	EF 470.00	789
ER 717.01	551	FD 029.00	845	LX 552.04	799	EF 471.00	789
ER 717.02	551	FD 030.00	211, 845	LX 552.05	799	EF 471.01	789
ER 718.01	551	FD 032.00	210	LX 552.06	799	EF 471.02	789
ER 730.02	553	FD 034.00	210	LX 552.10	799	EF 471.03	789
ER 730.04	553	FD 035.00	210, 845	LX 552.08	799	EF 472.00	789
ER 732.02	553	FF 500.00	746	LX 552.12	799	EF 472.01	789
ER 733.02	554	FF 500.02	746	LX 552.14	799	EF 472.02	789
ER 734.02	553	FF 500.03	746	LX 555.00	799	EF 472.03	789
ER 740.02	554	FF 500.04	746	LX 555.01	799	EF 475.00	789
ER 742.02	554	FF 505.01	746	LX 557.00	799	EF 477.00	789
EA 751.01	555	FF 505.10	746	LX 557.01	799	EF 477.01	789
EA 760.05	468, 555	FF 510.00	746	LX 557.02	799	EF 477.02	789
EA 760.07	468	FD 510.01	210	LX 557.03	799	EF 477.03	789
OP 762.01	555	FF 530.00	770	LX 557.04	798	EF 478.00	789
OP 762.02	555	FF 530.01	770	FE 557.04	768	EF 478.03	789
OP 770.00	555	FF 530.02	800	FE 557.05	768	EF 479.00	789
OP 770.01	555	FF 530.04	774	LX 558.00	799	EF 480.01	789
OP 774.00	555	FF 530.05	770	FE 558.04	768	EF 481.00	789
OP 780.00	823	FF 530.06	774	FE 558.05	768	EF 482.00	789
OP 795.00	555	FF 530.07	774	LX 560.01	798	EF 482.01	789
OP 796.00	555	FF 530.08	774	LX 560.03	798	EF 483.00	789
EF 800.00	502	FF 530.10	770	LX 560.05	798	EF 483.01	789
EA 810.00	468	FF 530.11	770	LX 560.07	798	EF 484.00	789
EA 811.00	469	FF 530.12	770	LX 560.09	798	EF 484.01	789
EA 812.00	468	FF 530.15	770, 774	LX 560.88	798	EF 484.02	789
		FF 530.16	770, 774			EF 484.03	789
				FA 040.01	409	EF 486.00	789
				FA 041.01	409	EF 487.00	789
				FA 042.01	409	EF 487.01	789
				FB 071.00	467	EF 488.00	789
				FB 080.00	754	EA 500.01	470
				FB 082.00	754	EA 502.01	471
				BM 083.00	204	EA 502.02	471

Kat. No. Cat. No.	Sayfa. Page.	Kat. No. Cat. No.	Sayfa. Page.	Kat. No. Cat. No.	Sayfa. Page.	Kat. No. Cat. No.	Sayfa. Page.
EA 502.03	471	ND 726.01	823	LS 621.01	814	JG 110.10WV	528
EA 503.00	471	ND 726.02	823	LS 621.02	814	JG 110.13WV	528
EA 503.01	471	ND 729.00	820	LS 621.03	814	JG 110.15WV	772
EA 504.00	471	ND 750.00	824	LS 622.00	814	JG 110.20WV	772
EA 504.01	471	ND 750.01	824	LS 622.01	814	JG 110.26WV	772
EA 505.00	470	ND 760.00	827	LS 623.00	814	JG 181.03F	528
EA 505.03	470	ND 760.01	827	LS 623.01	814	JG 181.05F	528
EA 505.04	470	ND 760.02	827	LS 644.00	414, 778	JG 181.07F	528
EA 505.06	470	ND 760.03	827	TE 644.00P	790	JG 181.10F	528
EA 509.00	470	FO 763.00	827	LS 645.01	814	JG 193.00	528
FH 530.00	749, 834, 832	FO 763.02	827	LS 645.02	814	JG 310.10WV	528
FH 536.00	749, 834, 832	FO 764.03	827	LS 645.03	814	JG 310.13WV	528
FH 536.01	749, 834, 832	EL 790.00	388, 524	LS 645.04	814	JG 310.15WV	528
FH 536.02	749, 834, 832	BT 790.01	388	LS 648.00	814	JG 310.20WV	528
FH 537.01	749, 834, 832	EL 791.00	524	LS 649.00	814	JG 310.26WV	528
FH 537.02	749, 834, 832	EL 792.00	798	LX 704.00	817	JG 380.03F	528
FF 540.00	749	EL 792.01	798	LX 704.01	817	JG 380.05F	528
FF 543.00	748	EL 792.02	798	LX 704.02	817	JG 380.07F	528
FF 543.01	748	MN 795.00	821	FR 704.05	812	JG 380.10F	528
FF 550.00	752	FB 850.00	608	LX 705.00	817	JG 393.00	528
FF 555.00	752	FB 852.00	608	LX 705.01	817	JG 840.00	527
FF 555.01	753	FB 852.01	608	LX 705.02	817	JG 841.00	527
FE 590.00	768	FB 854.01	608	LX 706.00	817	JG 841.01	527
FE 590.01	768	BT 885.00	831	LX 706.01	817	JG 842.00	527
FE 591.01	768	BT 886.00	391, 831	LX 706.02	817	JG 842.01	527
FE 595.00	768	FH 890.00	834	LX 707.00	817	JG 900.01	864
FE 595.01	768	FH 891.00	834	LX 707.01	817	JG 900.02	864
FE 596.00	768	FH 891.00P	417, 790, 791	LX 707.02	817	JG 900.03	864
FE 596.01	768	FH 995.00P	414	LX 710.00	817	JG 900.04	864
FE 596.02	768	FH 996.00	414	LX 710.01	817	JG 901.00	864
FE 596.03	768			LX 711.00	817	JG 902.00	864
FE 596.04	768			LX 712.00	817	JG 903.00	864
FE 596.05	768			LX 713.00	817	JG 904.00	864
FE 597.00	768	FF 500.00	747	KH 725.06	820	JG 904.01	864
FE 597.03	768	FF 500.01	747	KH 725.07	820	JG 904.02	864
FE 597.04	768	FF 500.02	747	KH 725.08	820	JG 904.03	864
FE 597.05	768	FF 500.03	747	KH 725.09	820	JG 904.04	864
FE 598.02	768	FF 500.04	747	KH 725.10	820	JG 904.06	864
FE 598.03	768	FF 500.05	747	KH 725.11	820	JG 905.00	864
FE 598.04	768	FF 500.06	747	KH 725.12	820		
FE 598.05	768	FF 500.07	747	KH 725.13	820	GK 001.00	859
FH 600.00	832	FF 500.08	747	KH 725.14	820	GK 002.00	859
FH 600.00	832	FF 500.10	747	KH 725.15	820	GK 003.00	859
FH 602.00	832	FF 500.11	747	KH 725.16	820	GK 004.00	859
FH 602.05	832	FF 500.15	747	KH 725.16	820	GK 005.00	859
FH 603.00	832	FF 501.01	747	GC 727.06	820	GK 006.00	859
FH 603.02	832	FF 501.02	747	GC 727.07	820	GK 009.00	859
LX 603.05	832	FF 502.01	747	GC 727.08	820	GK 010.00	859
LX 603.06	832	FF 502.02	747	GC 727.09	820	GK 012.00	859
LX 605.00	795	FR 554.01	812	GC 727.10	820	GK 015.00	859
FH 607.00	833	FR 599.00	811	GC 727.11	820	GK 015.01	859
FH 607.03	833	FR 600.00	811	GC 727.12	820	GK 015.02	859
FH 607.04	833	FR 601.00	811	GC 727.13	820	GK 016.00	859
FH 607.06	833	FR 603.00	812	GC 727.14	820	GK 016.01	859
FH 607.10	833	FR 603.01	812	GC 727.15	820	GK 016.02	859
FH 608.00	833	FR 603.01	812	GC 727.16	820	GK 017.00P	856, 858
FH 608.05	833	GB 605.00	812	FO 735.00	823	GK 017.02P	856, 858
FH 608.07	833	GB 606.00	812, 813	FO 736.00	823	GK 018.00P	856, 858
FH 608.10	833	GA 606.01	813	FO 737.00	823	GK 018.01P	856, 858
FH 609.00	833	GA 606.02	813	FO 750.00	815	GK 019.00P	856, 858
FH 609.05	833	GA 607.00	811	FO 752.00	815	GK 019.01P	856, 858
FH 609.06	833	FR 608.00	812	FO 754.00	815	GK 020.00P	856, 858
FH 609.07	833	LX 609.00	812	FO 754.04	815	GK 020.01P	856, 858
FH 609.08	833	FR 612.00	813	FO 754.05	815	GK 021.00P	856, 858
FH 609.10	833	FR 615.00	813	FO 754.06	815	GK 021.01P	856, 858
FH 609.12	833	LS 620.01	814	FO 761.00	604	GK 022.00P	856, 858
LS 616.00	814	LS 620.02	814	FO 761.01	604		
LS 621.00	816	LS 620.04	814	FO 761.02	604		
LS 622.00	816	LS 620.05	814	OL 765.00	825		
LS 622.01	816	LS 621.00	814	DO 766.00	825		
LS 623.00	816						
LS 623.01	816						
LS 625.00	816						
ND 701.00	821						
ND 711.00	821						
ND 712.00	821						
ND 714.00	821						
ND 720.00	822						
ND 721.00	822						
ND 725.00	823						
ND 726.00	823						

Kat. No. Cat. No.	Sayfa. Page.	Kat. No. Cat. No.	Sayfa. Page.	Kat. No. Cat. No.	Sayfa. Page.	Kat. No. Cat. No.	Sayfa. Page.
GK 022.01P	856, 858	GK 112.09	853	GK 215.01	851		
GK 022.10P	857, 858	GK 114.01	853	GK 215.02	851		
GK 022.11P	857, 858	GK 116.01	853	GK 230.00	855		
GK 023.00P	857, 858	GK 118.01	853	GK 230.01	855		
GK 023.01P	857, 858	GK 119.01	853	GK 230.03	855		
GK 023.10P	857, 858	GK 120.00	848	GK 230.05	855		
GK 023.11P	857, 858	GK 121.00	848	GK 231.00	855		
GK 024.00P	857, 858	GK 130.00	848	GK 231.01	855		
GK 024.01P	857, 858	GK 130.02	848	GK 231.03	855		
GK 024.10P	857, 858	GK 130.04	848	GK 231.05	855		
GK 024.12P	857, 858	GK 135.01	499	GK 232.01	855		
GK 026.00P	857, 858	GK 150.00	850	GK 232.03	855		
GK 026.01P	857, 858	GK 150.01	850	GK 232.05	855		
GK 030.00	858	GK 150.03	850	GK 256.01	855		
GK 032.00	858	GK 151.01	850	GK 258.02	855		
GK 032.10	858	GK 151.03	850	GK 260.00	855		
GK 034.00	858	GK 160.00	850	GK 260.01	855		
GK 035.00	858	GK 160.01	850	GK 260.02	855		
GK 036.00	858	GK 160.02	850	GK 270.00	863		
GK 037.00	858	GK 160.03	850	GK 309.00	863		
GK 037.01	858	GK 160.04	850				
GK 038.00	854	GK 160.05	850				
GK 039.00	854	GK 160.06	850				
GK 040.00	862	GK 160.07	850				
GK 041.00	862	GK 160.08	850				
GK 041.03	854	GK 160.09	850				
GK 042.05	854	GK 160.10	850				
GK 043.00	862	GK 160.11	850				
GK 043.01	862	GK 160.12	850				
GK 043.05	854	GK 160.13	850				
GK 044.00	862	GK 160.14	850				
GK 044.01	862	GK 160.15	850				
GK 044.02	862	GK 160.16	850				
GK 045.00	862	GK 160.17	850				
GK 045.04	854	GK 160.18	850				
GK 046.00	860	GK 160.19	850				
GK 047.05	854	GK 160.20	850				
GK 048.00	861	GK 160.21	850				
GK 050.00	861	GK 160.22	850				
GK 050.01	861	GK 160.23	850				
GK 050.02	861	GK 160.26	850				
GK 051.01	860	GK 170.01	849				
GK 051.03	860	GK 170.04	849				
GK 052.01	860	GK 170.07	849				
GK 052.03	860	GK 171.01	849				
GK 054.01	860	GK 172.01	849				
GK 055.01	860	GK 180.00	852				
GK 057.00	861	GK 180.01	852				
GK 057.02	861	GK 180.02	852				
GK 057.03	861	GK 184.00	852				
GK 060.00	863	GK 200.00	851				
GK 065.00	863	GK 200.01	851				
GK 095.00	859	GK 200.02	851				
GK 096.00	858, 859	GK 200.03	851				
GK 097.00	859	GK 200.04	851				
GK 097.01	858	GK 200.05	851				
GK 097.02	858	GK 200.06	851				
GK 098.01	858	GK 200.07	851				
GK 098.03	858	GK 200.08	851				
GK 100.00	848	GK 200.09	851				
GK 110.01	853	GK 200.10	851				
GK 110.03	853	GK 200.11	851				
GK 110.05	853	GK 202.00	851				
GK 110.08	853	GK 202.02	851				
GK 110.09	853	GK 202.04	851				
GK 112.01	853	GK 213.00	851				
GK 112.03	853	GK 213.01	851				
GK 112.05	853	GK 213.02	851				
GK 112.08	853	GK 215.00	851				

 ARGENT